

Building Information Modelling (BIM) Training

<https://ibse.hk/BIM-Training/>



1.2 Basic concepts of BIM



Ir Dr. Sam C. M. Hui

Department of Mechanical Engineering

The University of Hong Kong

E-mail: cmhui@hku.hk

Jun 2024

Contents



- History: From 2D to BIM
- BIM elements and standards
- BIM dimensions
- BIM maturity levels
- Level of development (LOD)



History: From 2D to BIM

- BIM concept has existed since the late-50s

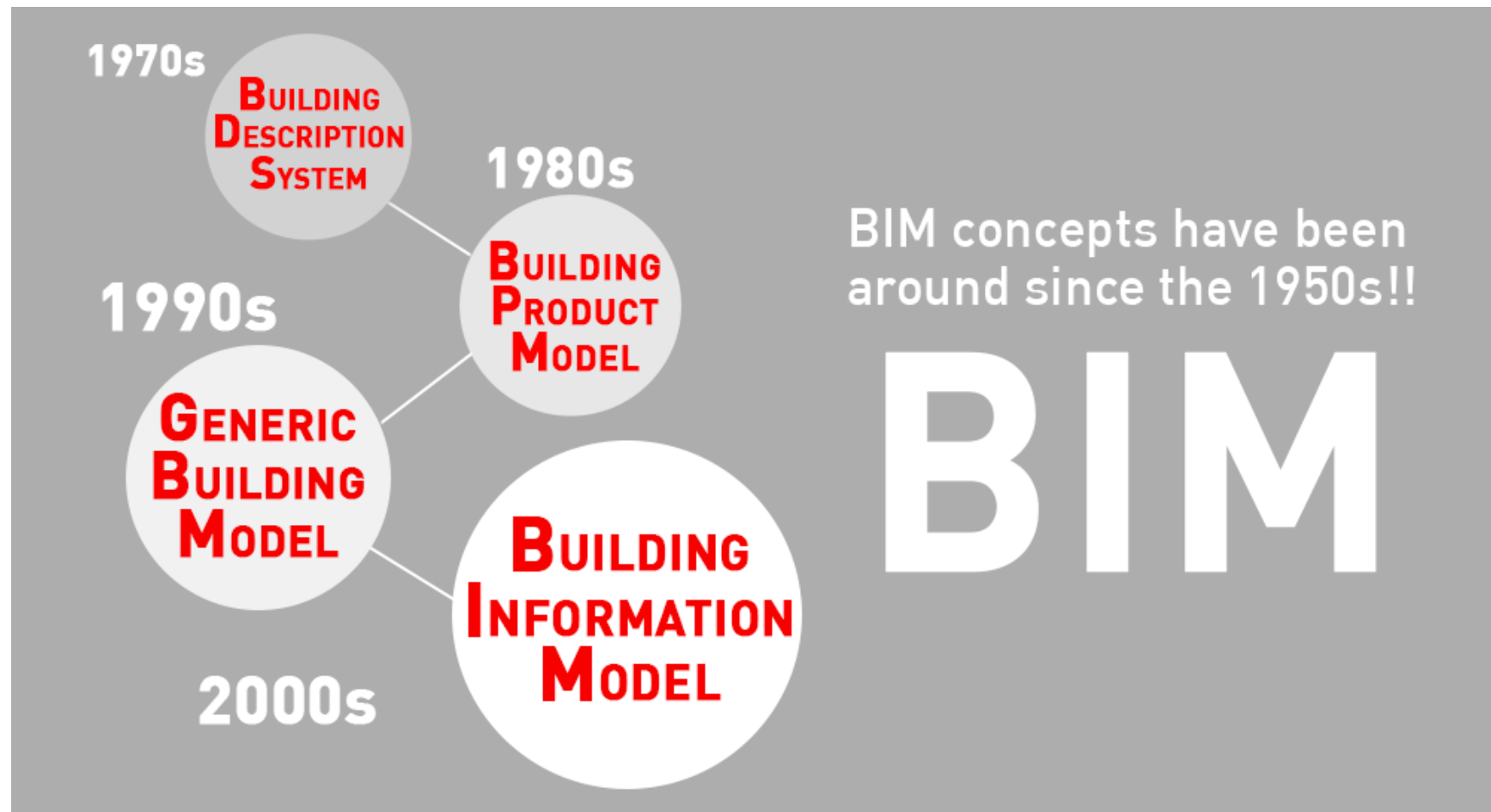

Evolution of AEC CAD

- 2D solutions
 - Electronic drafting board
- 3D solutions
 - Modeling for pure visualization purposes
- BIM solutions
 - Models with integrated architectural information
- 4D-5D BIM - Construction Coordination
 - Timing/scheduling and Cost estimation
- 6D-7D BIM
 - Facility Management and Life Cycle Management

(*AEC = Architecture, Engineering and Construction; CAD = Computer-aided Design)

AEC CAD Timeline

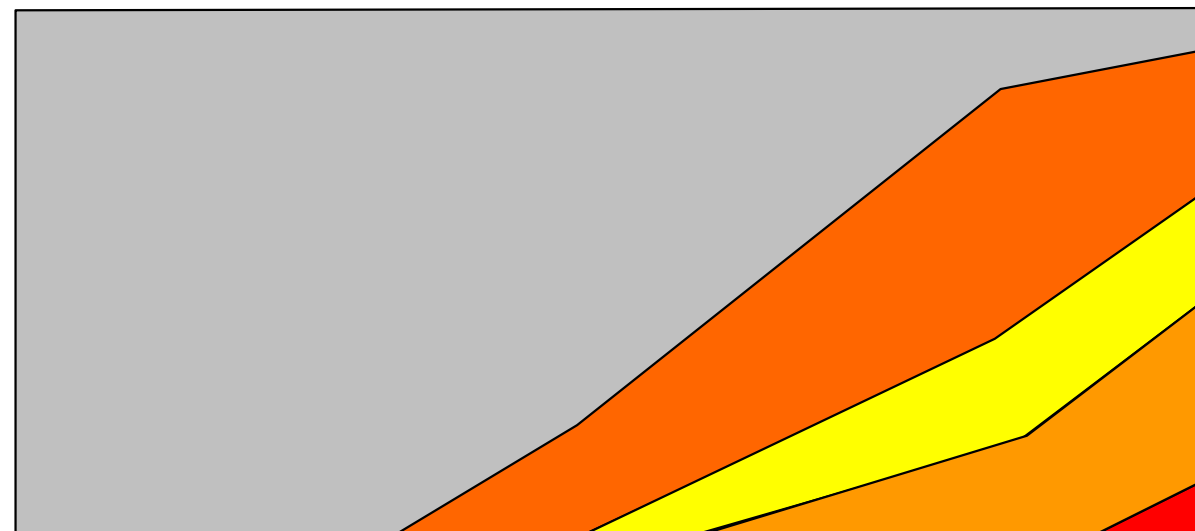
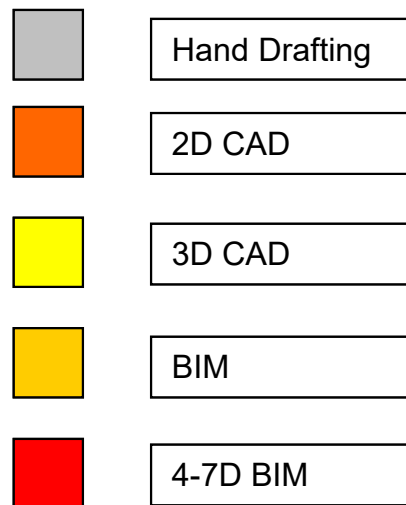
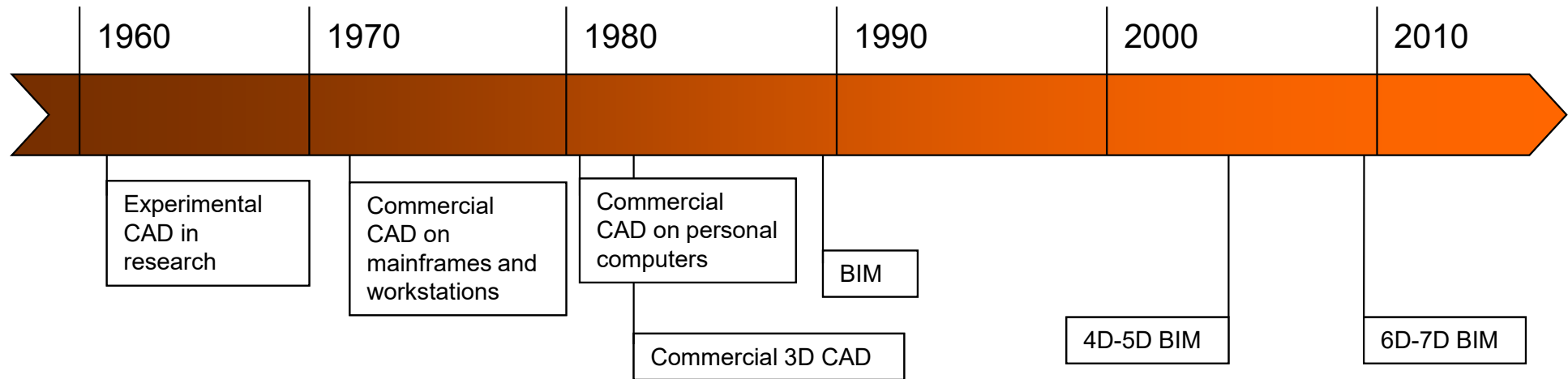

2D CAD - Workflow

- Design and document all in 2D
- No 3D model
- Drawings in separate files
- Manual coordination of drawings
- No visualization and calculation tools



2D CAD - Evaluation

Benefits

Compared to hand drafting

- Fast modifications
- Accuracy
- Intelligent drafting tools (fills, dimensions)
- Repetitive element handling (blocks, xrefs)

Compared to 3D CAD and BIM

- Simple working concept (electronic drafting)
- Relatively small file size (only 2D data)
- Workflow is applicable for all building types

Drawbacks

Compared to 3D CAD and BIM

- Drawings are not coordinated automatically
- No 3D visualization
- No automatic calculations, quantity take-offs or schedules
- No collision detection



3D CAD - Workflow

- CAD application has 2D & 3D capabilities
- Buildings can be modeled in 3D
- 3D and 2D information can be included in one file
- Drawings are (partially) derived from the model
- No automatic documentation
- Applications mostly works with 2D and 3D tools instead of real architectural elements
- Basic visualization and calculation tools

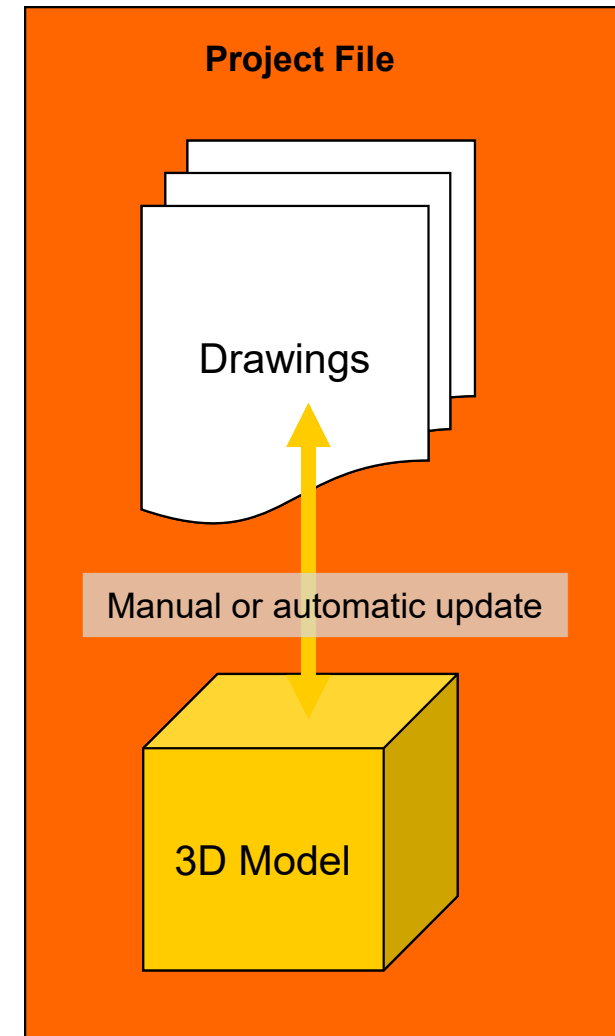

3D CAD - Evaluation

• Benefits

- Compared to 2D CAD
- Easier identification of design problems
- Faster change management
- Visualization and calculation capabilities
- Compared to BIM
- 3D modeling is optional
- Smaller file size

• Drawbacks

- Concept doesn't follow the architectural design process
- No automatic documentation
- No real architectural elements

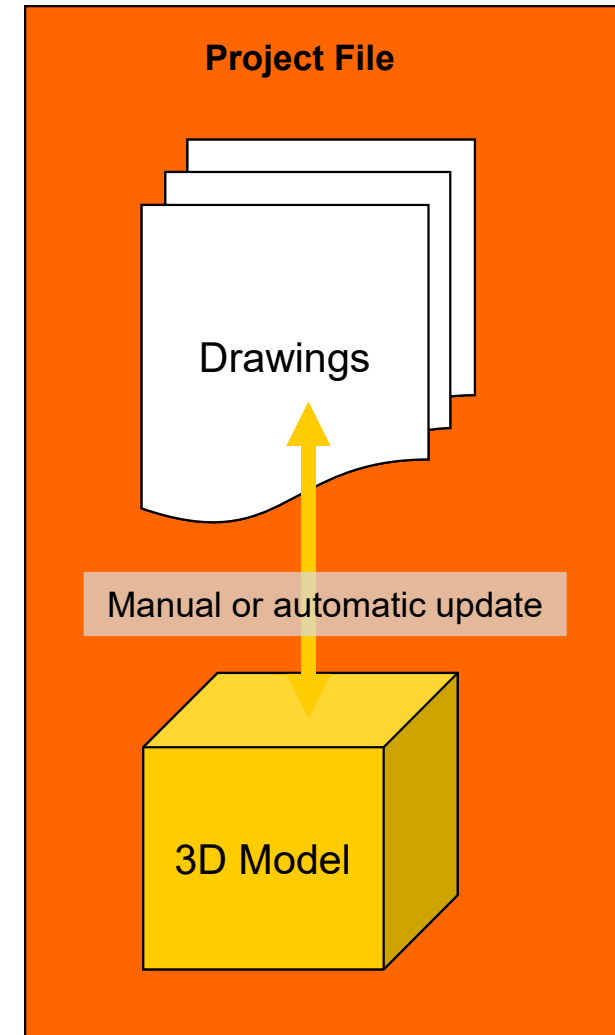

The BIM Concept

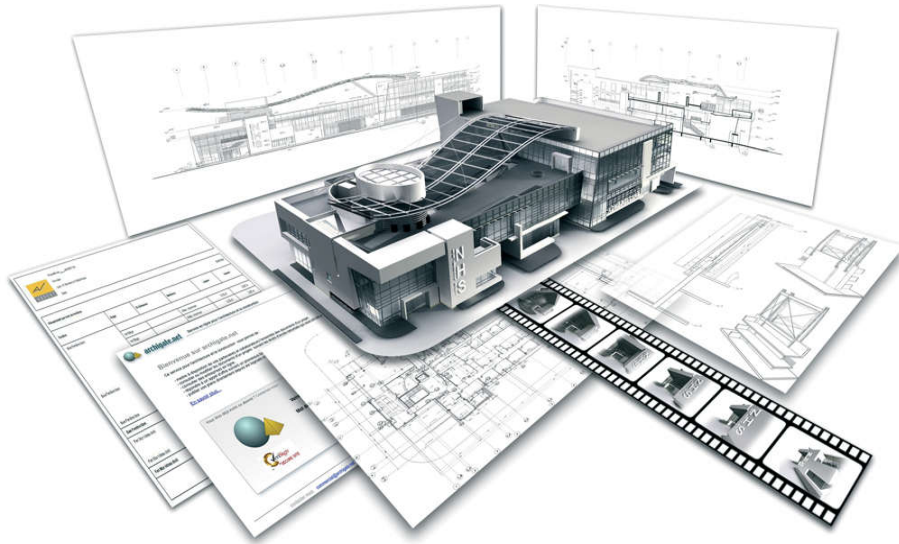

NHS Office, www.paastudio.com

BIM = Building Information Modeling

Also known as „Virtual Building” or „Building Simulation”

Drawings, model views, visualizations, calculations and quantity take-offs are automatically derived from the 3D model.

BIM - Workflow

- Single file concept:
 - The complete building model and all of its representations are included in the virtual building file
- Real architectural elements used for modeling
- Changes of the model affects all drawings, and vice versa
- Automatic documentation workflow
- Rich architectural content (libraries)
- Building information data attached to the elements
- Internal visualization tools
- Calculations, schedules

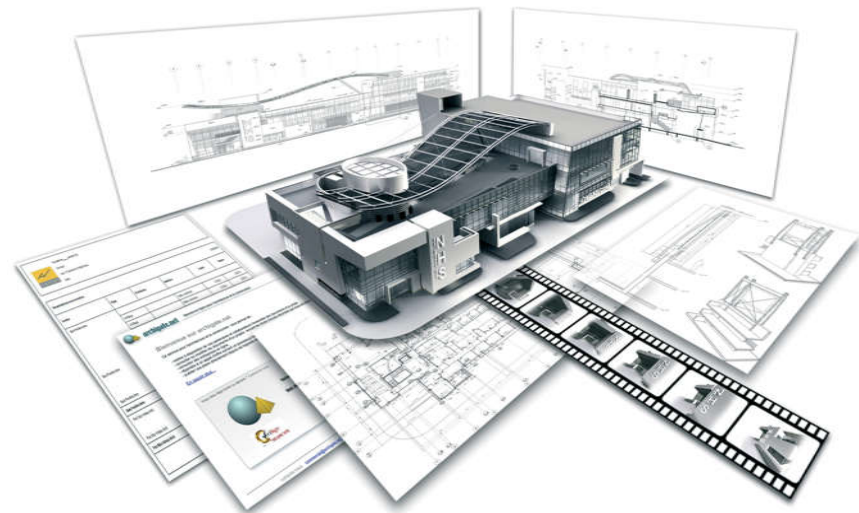

NHS Office, www.paastudio.com

BIM - Evaluation

Benefits

Compared to 2D and 3D CAD

- Real architectural elements
- Automatic drawing coordination
- Rich visualization content (animation, sun studies, renderings etc.)
- Automatic quantity take-offs, schedules
- Connection to structural, MEP, energy calculation and collision detection applications

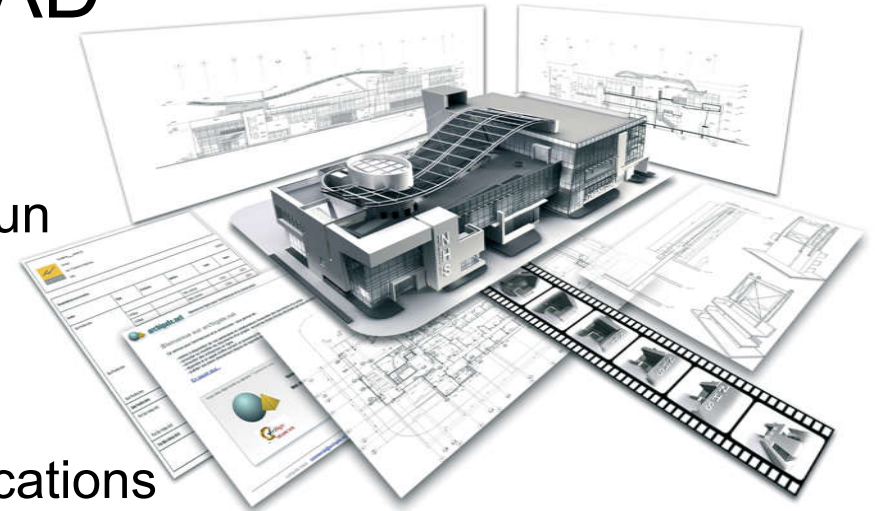

NHS Office, www.paastudio.com

Drawbacks

Compared to 2D and 3D CAD

- Might be difficult to learn the BIM approach for 2D cross-graders
- Training requirements

BIM elements and standards



- Typical elements:
 - Architecture, MEP (Building Services), Structure
- Information:
 - Model based documentation
 - Calculations and analyses
- Collaboration
 - External, internal, teamwork
- BIM Standards, e.g. in UK, USA and HK

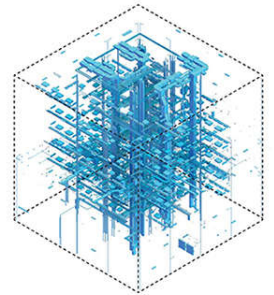
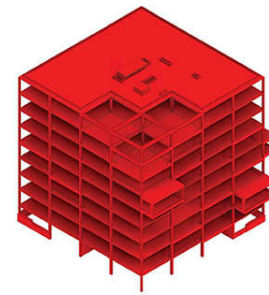
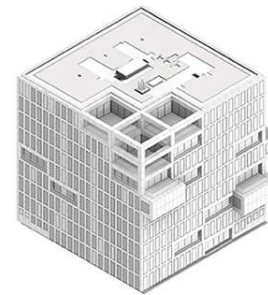

BIM - Real Architectural Elements

Drawing representation

- Floor plan, section and elevation views
- Adjustable contours, fills, backgrounds
- Scale sensitivity

Model representation

- 3D shapes connected to drawing element
- Surface color and texture

Non-graphical information

- Material descriptions
- Quantities, volumes
- Cost

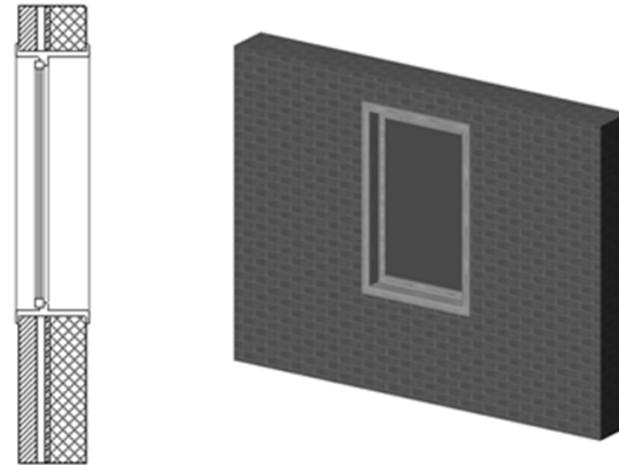

TEXTFIELD 1
TEXTFIELD 2
TEXTFIELD 3
TEXTFIELD 4

Window Schedule	2006. 03. 06.
-----------------	---------------

W1 Casement 	Width:	0,90 m	1 piece(s)
	Height:	1,50 m	
	User ID	W01	
	Opening orientation	0	
	Material	Wood-Pine	

Example of MEP (Building Services) elements: A valve

INPUT

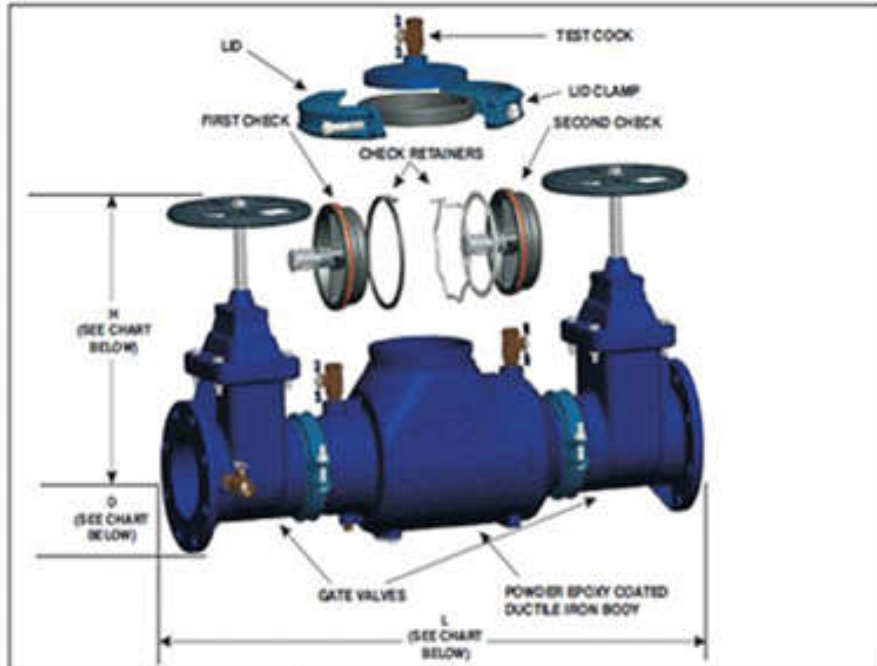

Model No.	Size	L	H OSY OPEN	H NRS	O	OPTIONAL VARIATIONS:	SUFFIX
FDC2.50	2 1/2"	33.5	18.88	16.38	7	<input type="checkbox"/> Non Rising Stem Gate Valve	-NRS
FDC3.00	3"	34.5	21.88	18.88	7.5	<input type="checkbox"/> Outside Stem and Yoke Gate Valve	-OSY
FDC4.00	4"	40.8	25.63	21.60	9	<input type="checkbox"/> Meets Buy America and Pennsylvania Steel Act	-BA
FDC6.00	6"	43.8	35.13	29.13	11	<input type="checkbox"/> Strainer attached	-S
FDC8.00	8"	56.5	44.63	36.60	13.5	<input type="checkbox"/> Double Check Detector Assembly	-DCDA
FDC10.00	10"	59.5	54.5	44.5	16	<input type="checkbox"/> Grooved Flange Connection	-G
						<input type="checkbox"/> No Gate Valves	-LF

OUTPUT

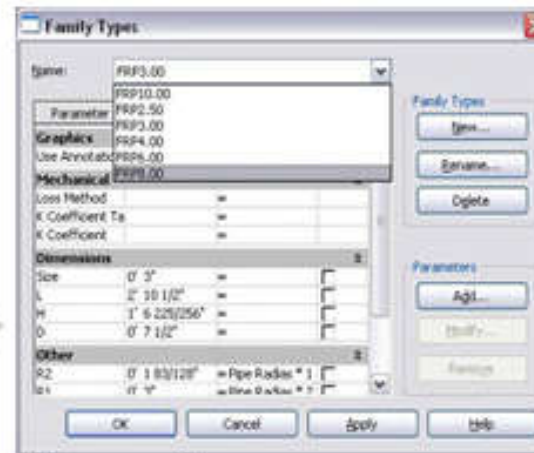

Views (all)
 Top Plans
 Ref. Level
 Ring Plans
 Ref. Level
 Views
 View 1
 (3D)
 Sections (Elevation 1)
 Back
 Front
 Left

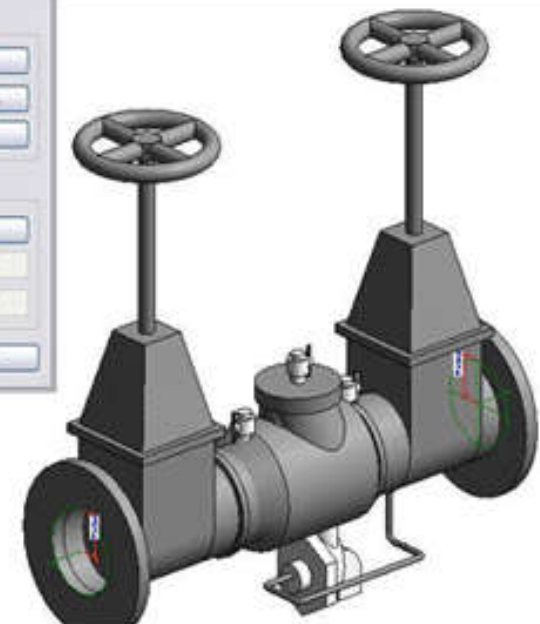

BIM structure elements and structural analysis

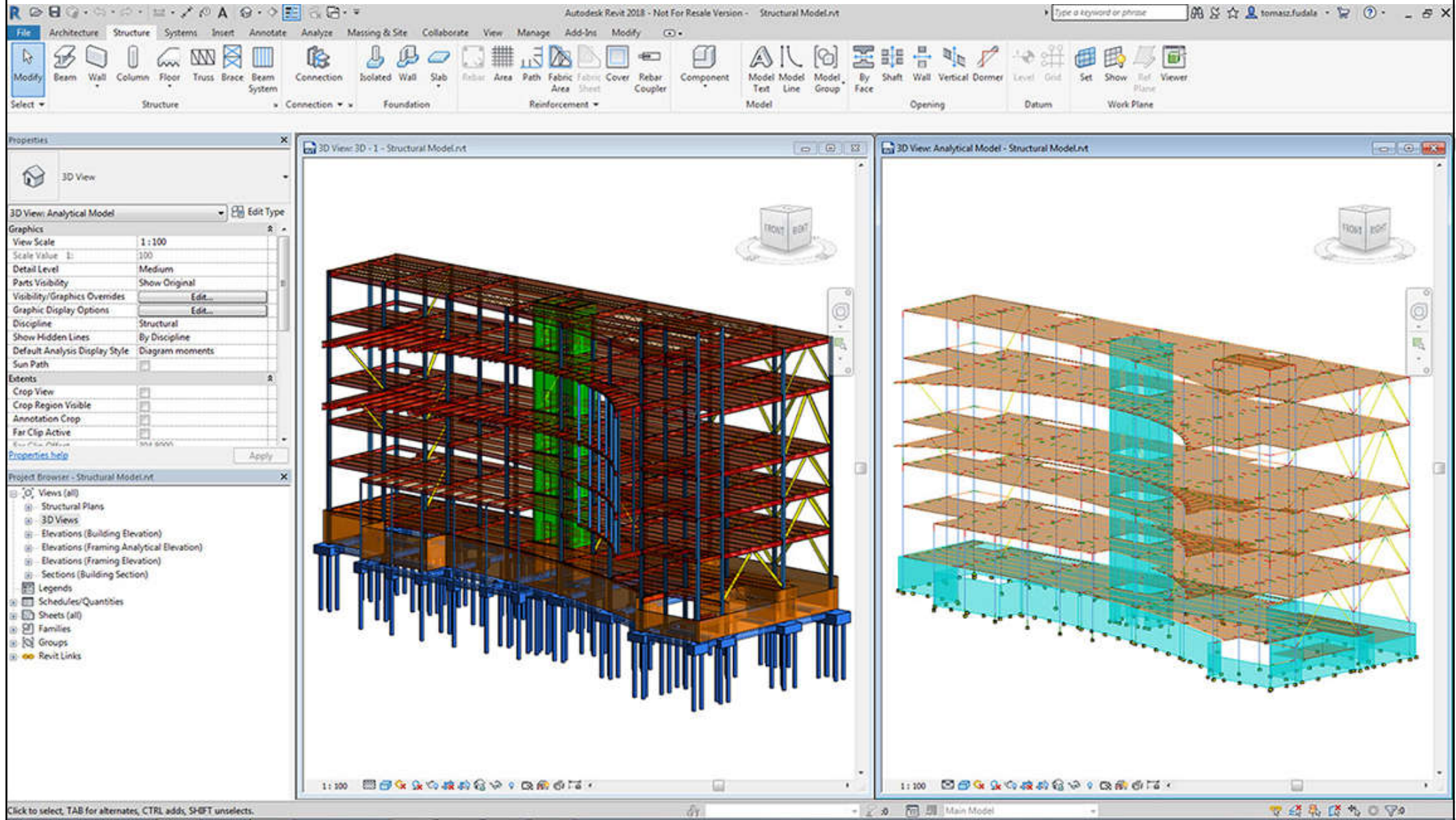

BIM - Model Based Documentation

- Coherence between model and drawing
- All drawings derived from the model
- Model coordinates drawings
- Scale sensitive elements
- The complete project lifecycle can be controlled from a single file
- Rich 3D visualization content

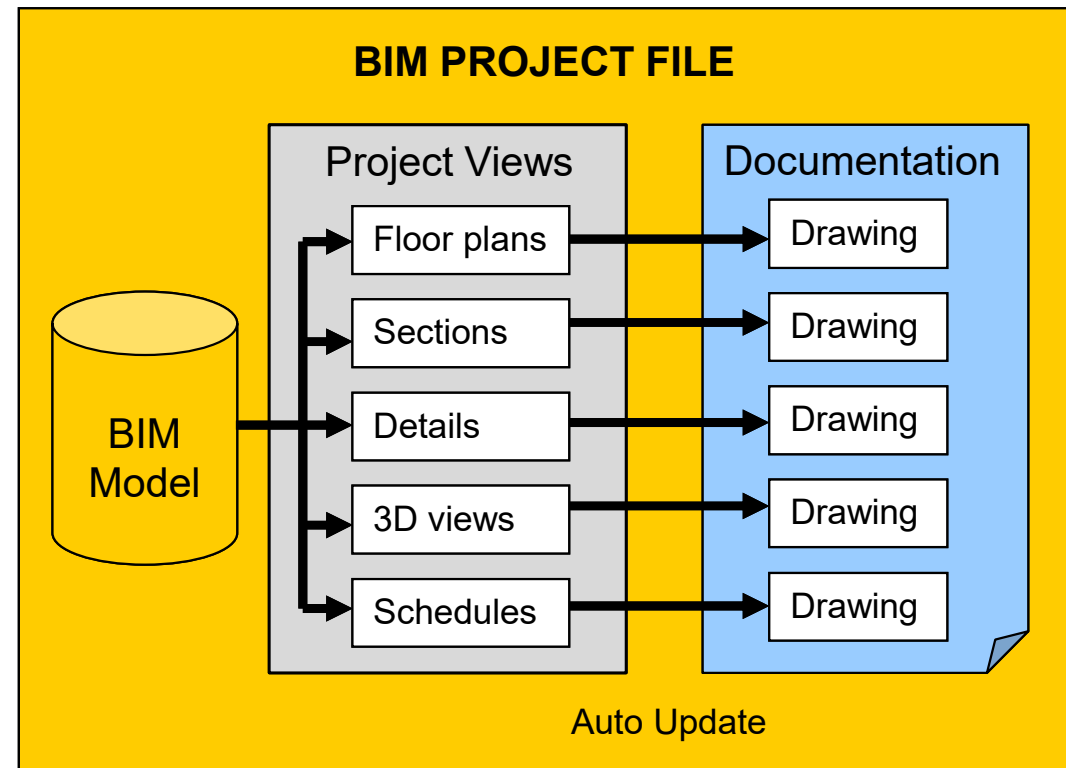

BIM - Calculation

Additional information attached to a model

- Quantity
- Materials
- Descriptions
 - Product details
 - Construction details
 - Safety details
- Cost

Instant Calculation

- Quantity takeoffs
- Room Inventories
- Door & Window schedules

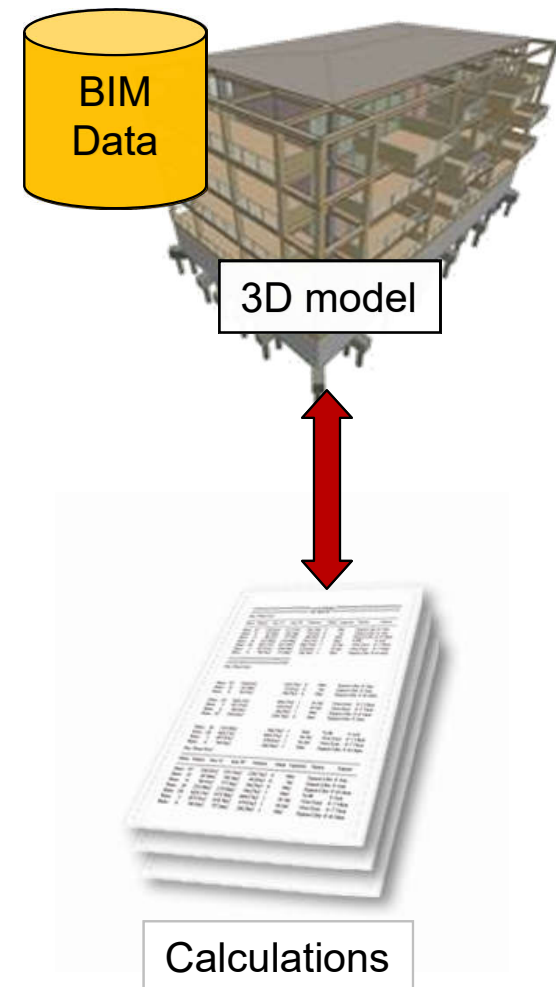

BIM - Collaboration

The AEC industry is moving toward integration of disciplines.

The collaborative mode will become a standard approach.

Collaboration solutions in BIM:

- Internal Collaboration
- External Collaboration

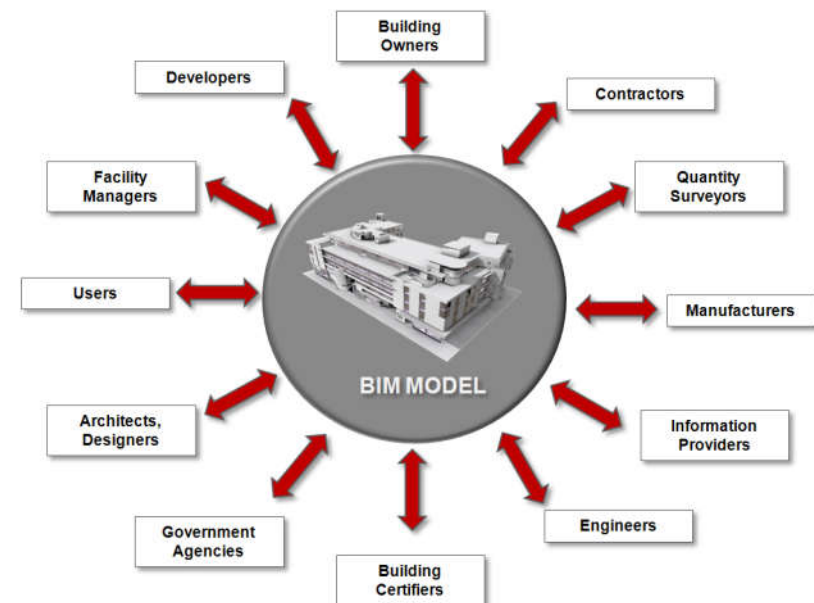
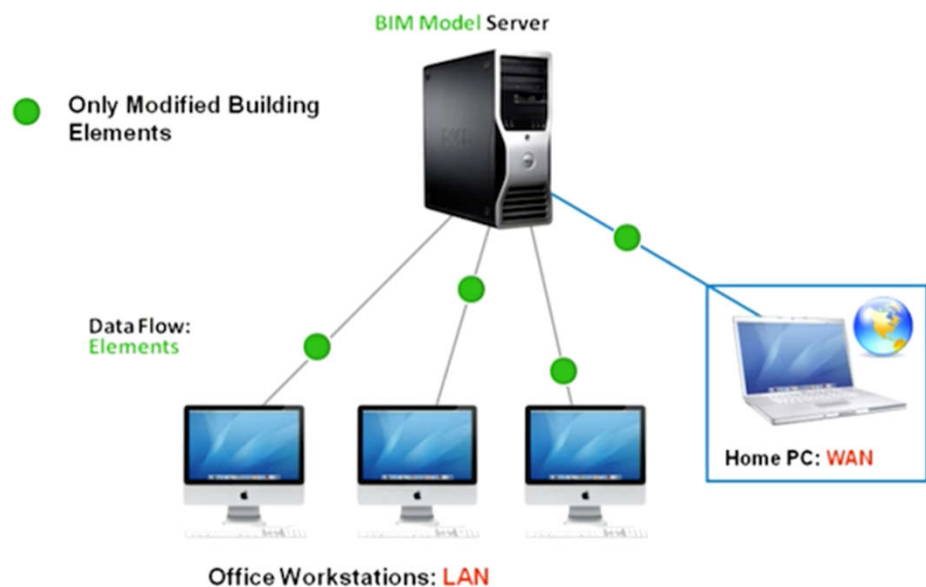

BIM - External Collaboration

BIM applications allow the sharing of building data with the project stakeholders via many file formats:

- IFC
- DXF-DWG
- PDF
- XML
- Native file formats
-

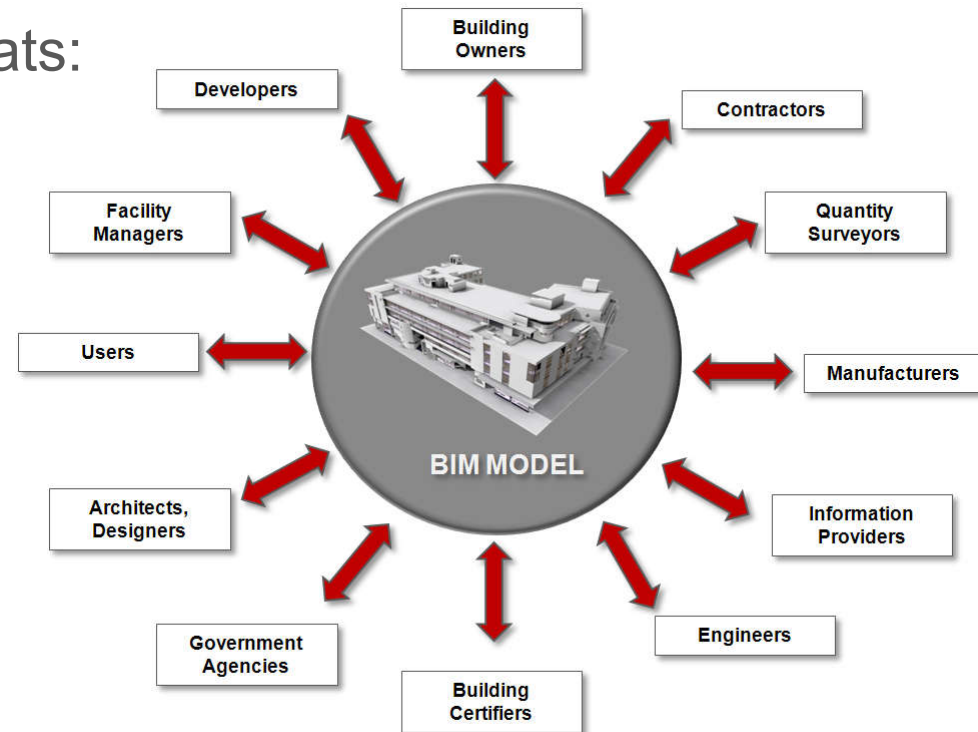

BIM - Internal Collaboration

Advanced BIM applications allow the seamless sharing of the virtual building data between the project team members

The most common project sharing methods are:

- Hotlinked file methods
- File-server based teamwork solutions
- Client-server based teamwork solutions

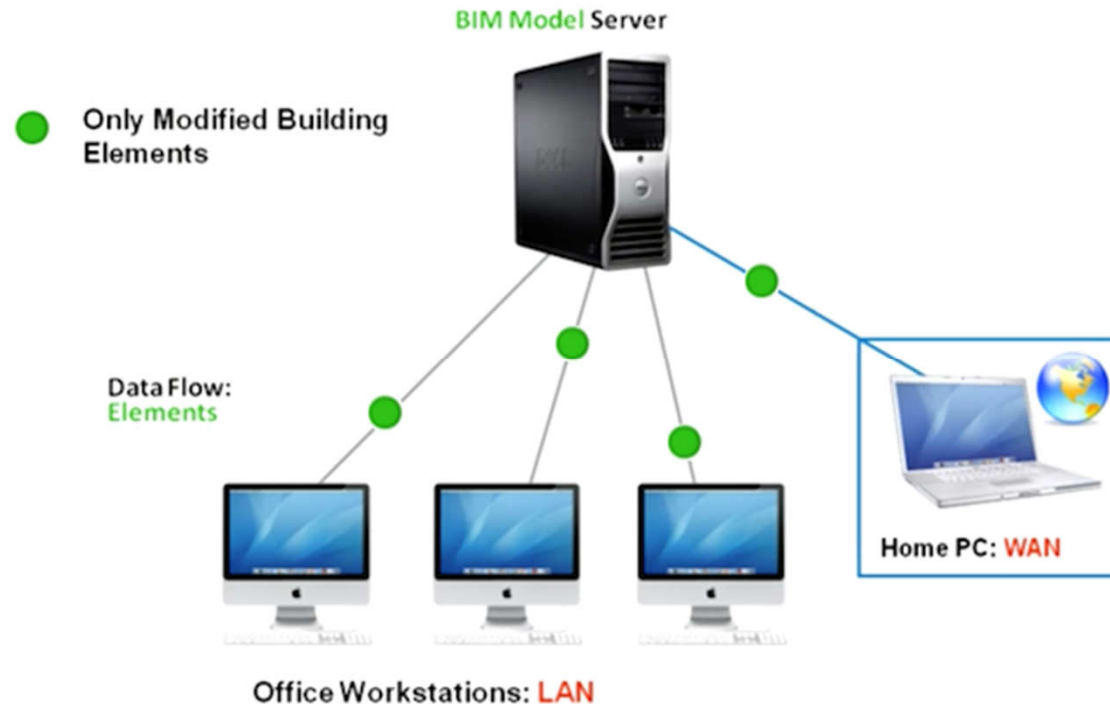

BIM - Teamwork

- Teamwork solutions in BIM applications are usually based on the following concept:
 - Central file contains the complete virtual building database
 - Team members work on local copies of the project
 - Team members have dedicated workspaces
 - Team members send and receive changes between the server and their local project copies

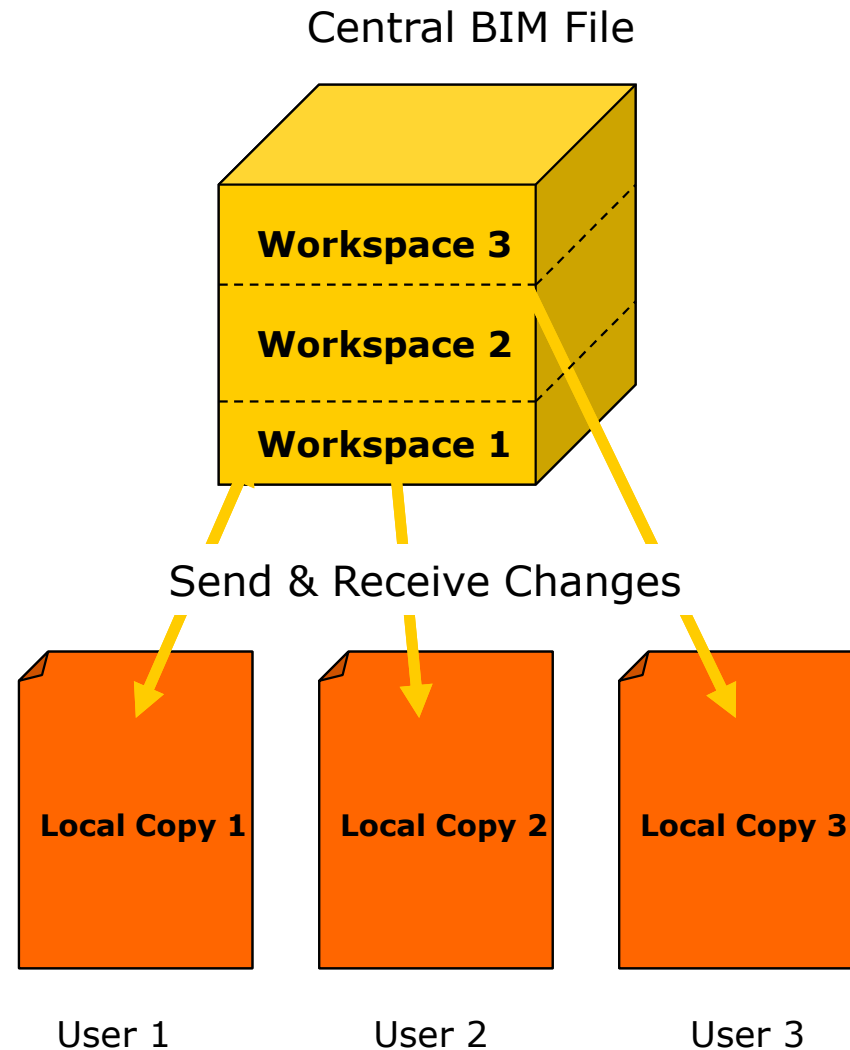

BIM - Analysis, Coordination

Further processing the BIM data in third party applications allows a wide range of analytical activities:

- Code checking (collision detection)
- Energy efficiency analysis
- Structural analysis

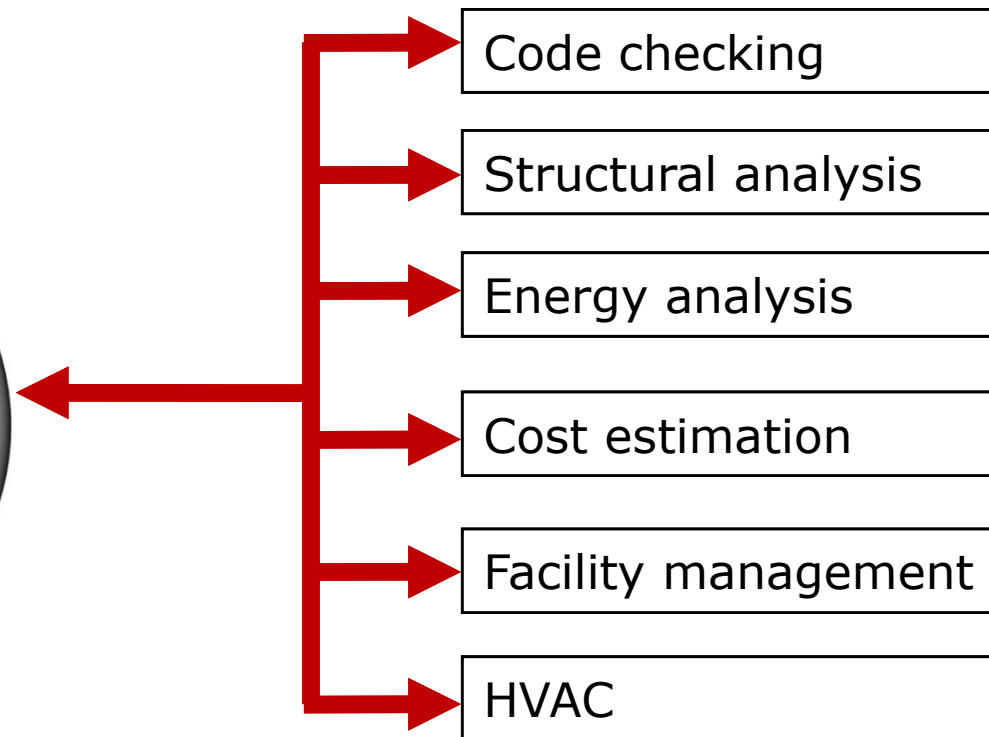

BIM - AEC CAD standards

- BS 1192 (British Standards) widely used in the UK
- AIA CAD Layer Guidelines is widespread in the U.S.
- Uniformat is a U.S. standard for the organization of building elements
- ISO 13567 International standard, common in Northern Europe

			1	A-FURN
			1	A-GLAZ-FULL
			1	A-LITE
			1	A-MARK-DETL
			1	A-MARK-ELEV
			1	A-MARK-SECT
			1	A-NPLT
			1	A-NPLT-HTSP
			1	A-NPLT-SEO
			1	A-PICT
			1	A-ROOF
			1	A-WALL-EXTR
			1	A-WALL-INTR
			1	C-TOPO
			1	C-TOPO-02FT
			1	C-TOPO-10FT
			1	C-TOPO-TEXT
			1	E-POWR

U.S. National CAD Standard (NCS) - layer name format

Discipline		Major Group			Minor Group			Minor Group			Status							
A	I	-	W	A	L	L	-	F	U	L	L	-	D	I	M	S	-	N

AEC (UK) CAD Standard - layer name format

Role	Classification			Presentation	Description				View					
A	-	G	2	2	-	M	-	F	I	O	O	R	-	Fwd

BIM - AEC (UK) BIM standards

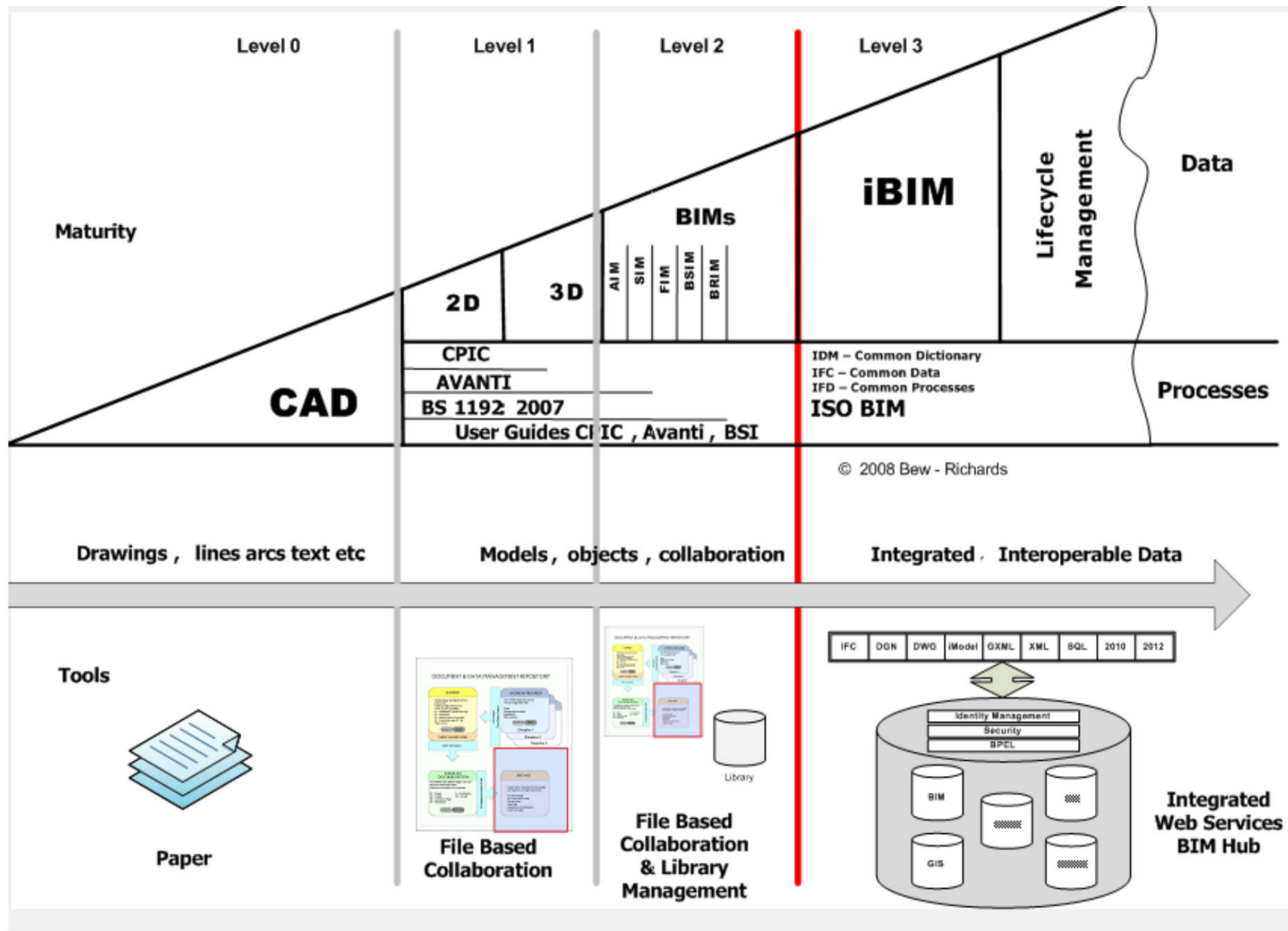

[Source – M.Bew and M.Richards 2008]

(Source: Graphisoft BIM Curriculum <http://www.graphisoft.com/learning/bim-curriculum/>)

BIM elements and standards



- Common protocols and standards:
 - PAS 1192-2 Specification for information management for the capital/delivery phase of construction projects using Building Information Modelling
 - PAS 1192-3 Specification for information management for the operational phase of construction projects using building information modelling
 - Industry Foundation Classes (IFC)
 - COBie (Construction Operations Building Information Exchange)

BIM standards in Hong Kong (from Construction Industry Council)

CIC BIM Standards-related Publications (**new** / **updates** in 2021)

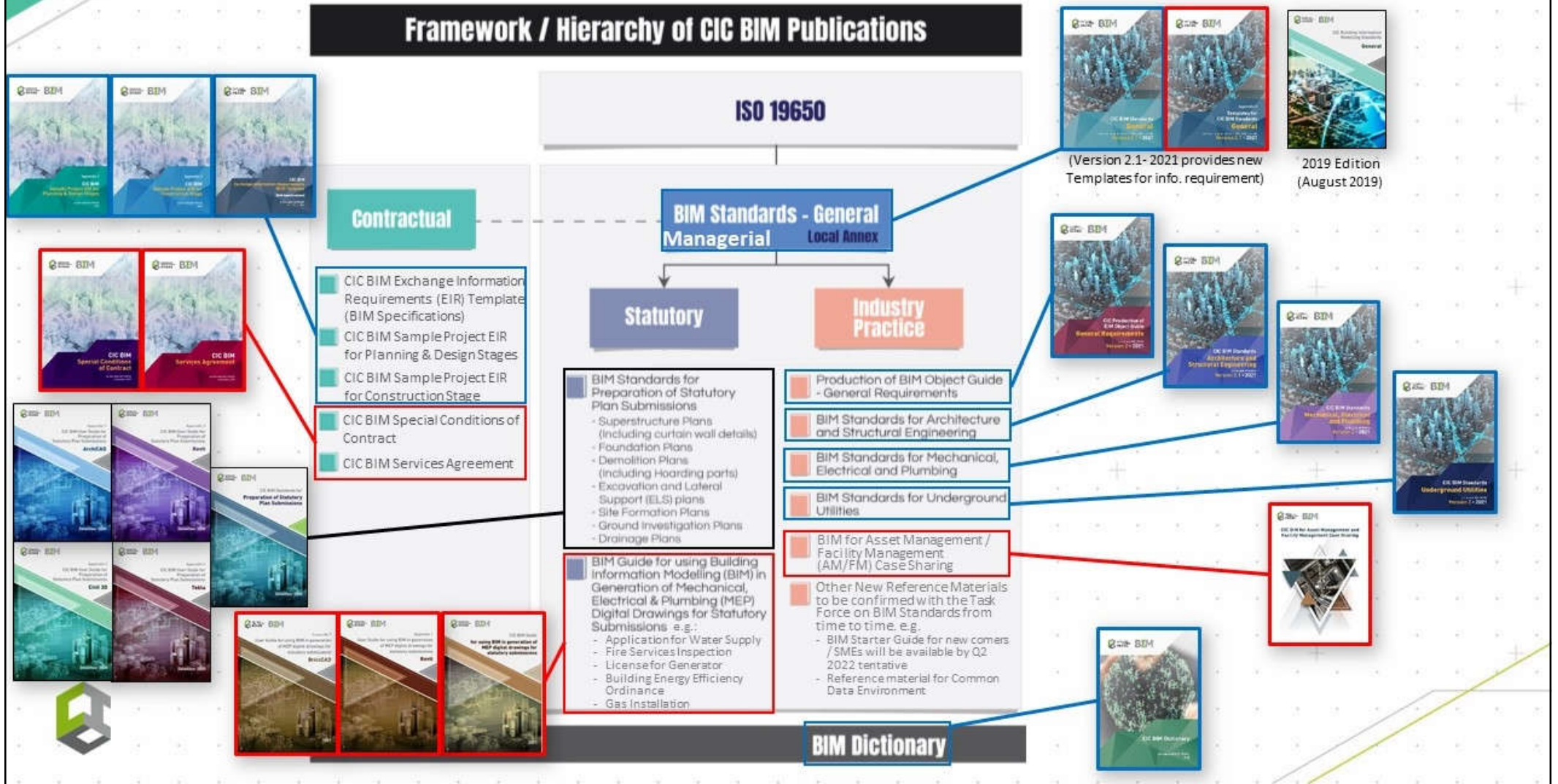

Virtual Construction

- Construction industry is moving towards automated solutions. Adding time and cost information to the 3D model results the virtual construction model.

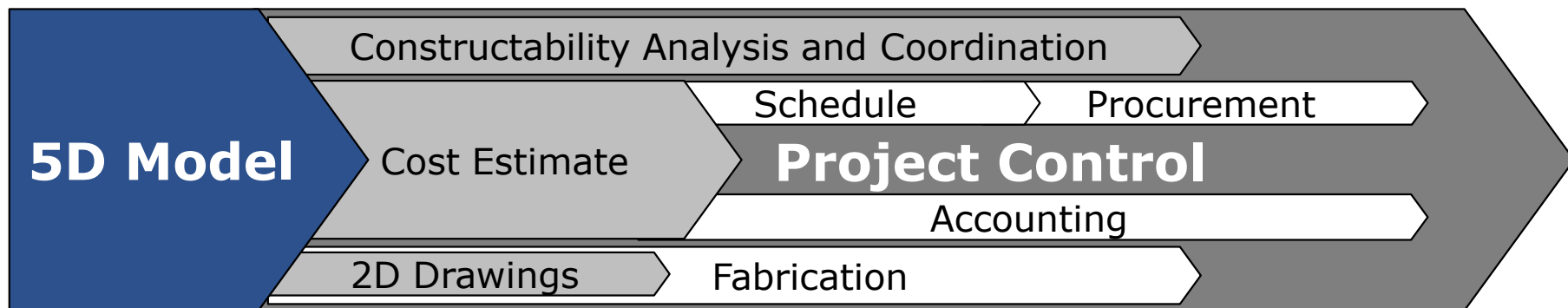
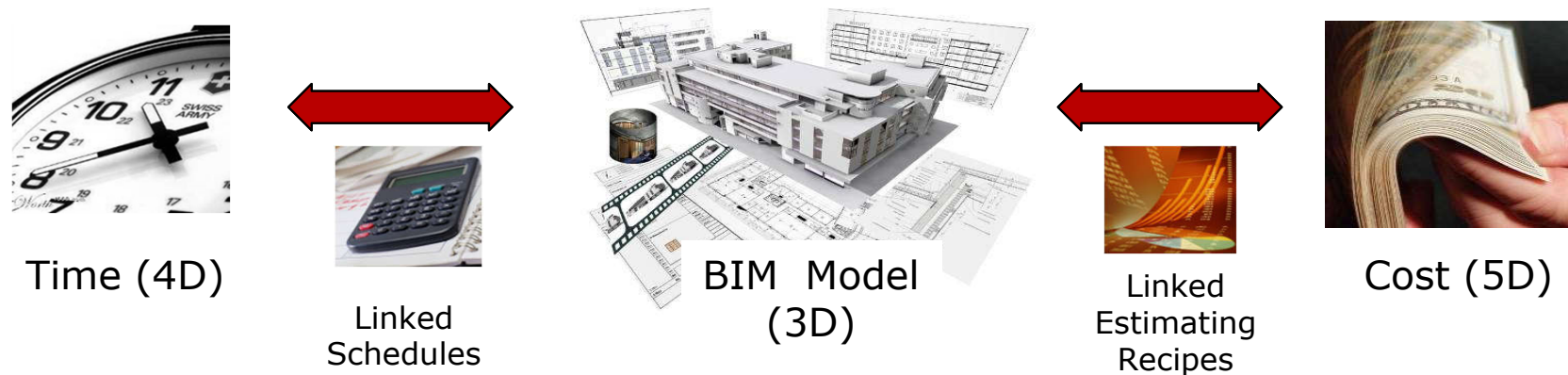

BIM dimensions

3D

- Existing Conditions Models
 - Laser scanning
 - Ground Penetration Radar (GPR) conversions
- Safety & Logistics Models
- Animations, renderings, walkthroughs
- BIM driven prefabrication
- Laser accurate BIM driven field layout

4D

SCHEDULING

- Project Phasing Simulations
- Lean Scheduling
 - Last Planner
 - Just In Time (JIT) Equipment Deliveries
 - Detailed Simulation Installation
- Visual Validation for Payment Approval

5D

ESTIMATING

- Real time conceptual modeling and cost planning (DProfiler)
- Quantity extraction to support detailed cost estimates
- Trade Verifications from Fabrication Models
 - Structural Steel
 - Rebar
 - Mechanical/Plumbing
 - Electrical
- Value Engineering
 - What-if scenarios
 - Visualizations
 - Quantity Extractions
- Prefabrication Solutions
 - Equipment rooms
 - MEP systems
 - Multi-Trade Prefabrication
 - Unique architectural and structural elements

6D

SUSTAINABILITY

- Conceptual energy analysis via DProfiler
- Detailed energy analysis via EcoTech
- Sustainable element tracking
- LEED tracking

7D

FACILITY MANAGEMENT APPLICATIONS

- Life Cycle BIM Strategies
- BIM As-Built
- BIM embedded O&M manuals
- COBie data population and extraction
- BIM Maintenance Plans and Technical Support
- BIM file hosting on Land Lease's Digital Exchange System

BIM dimensions

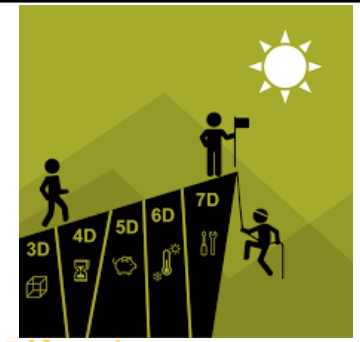

- Very broadly, building information includes:
 - 2D
 - 3D
 - 4D (including time / programme information)
 - 5D (including cost information)
 - 6D (including facilities management information)
- Parametric software modelling is used
- The **common data environment (CDE)** is the single source of information for the project

BIM dimensions: 1D to 6D

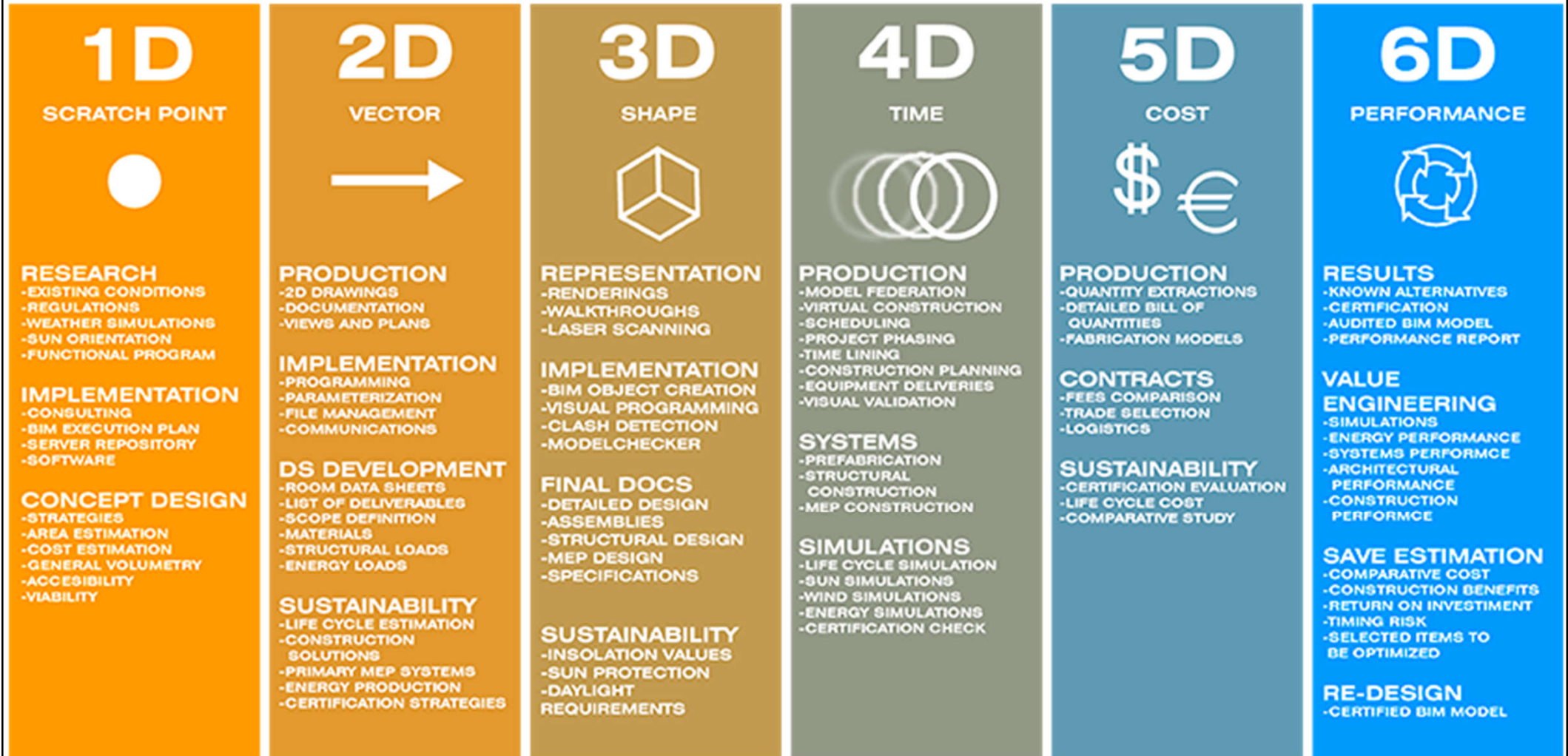

Note: the 6D is sometimes associated with Facility Management activity or Sustainability.

BIM dimensions

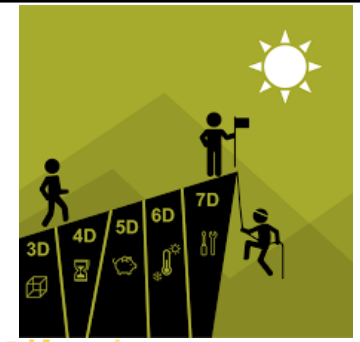

- **3D + Time = 4D Schedule**
 - Better communication for construction sequencing
 - Better site planning & logistics
 - Better analysis for project management
 - Uncovers flawed logic in the schedule from visual
- **4D + Quantity + Cost = 5D**
 - QTO – Quantity Take Off (in minutes), estimation
 - Spot the difference – track changing variables
 - Auto search & dynamic document of record

BIM dimensions

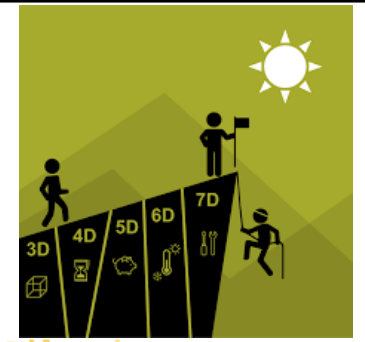

- **5D + Facility Information = 6D**
 - As-builts are delivered as a Model
 - O&M data – Technical product info – Warranty info – Maintenance schedule/history – All exist in the Model
 - Space utilization tool – Simplify remodels – lease and rental analysis tools
- **7D? or nD? = Sustainability, Safety**

6D

+LIFE CYCLE



LIFE CYCLE READY
GREAT MODEL DETAIL
COMPLETE PARAMETERS

5D

+COST

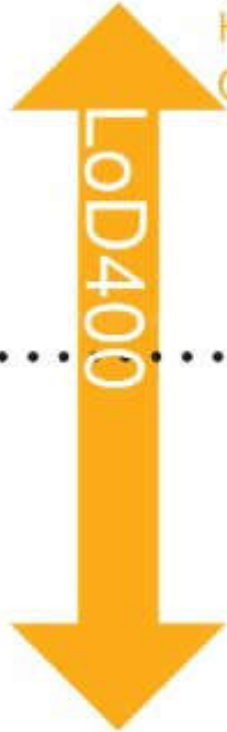

HIGHEST LEVEL OF MODEL DETAIL
CONSTRUCTION PARAMETERS



GREAT MODEL DETAIL
CONSTRUCTION PARAMETERS

4D

+TIME



GENERAL MODEL DETAIL
GENERAL PARAMETERS

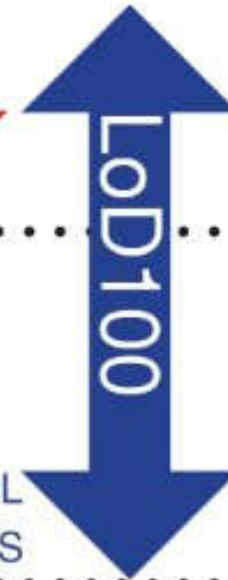

3D

3D MODEL

MASSED MODEL
ANALYTICAL PARAMETERS

The big picture of BIM

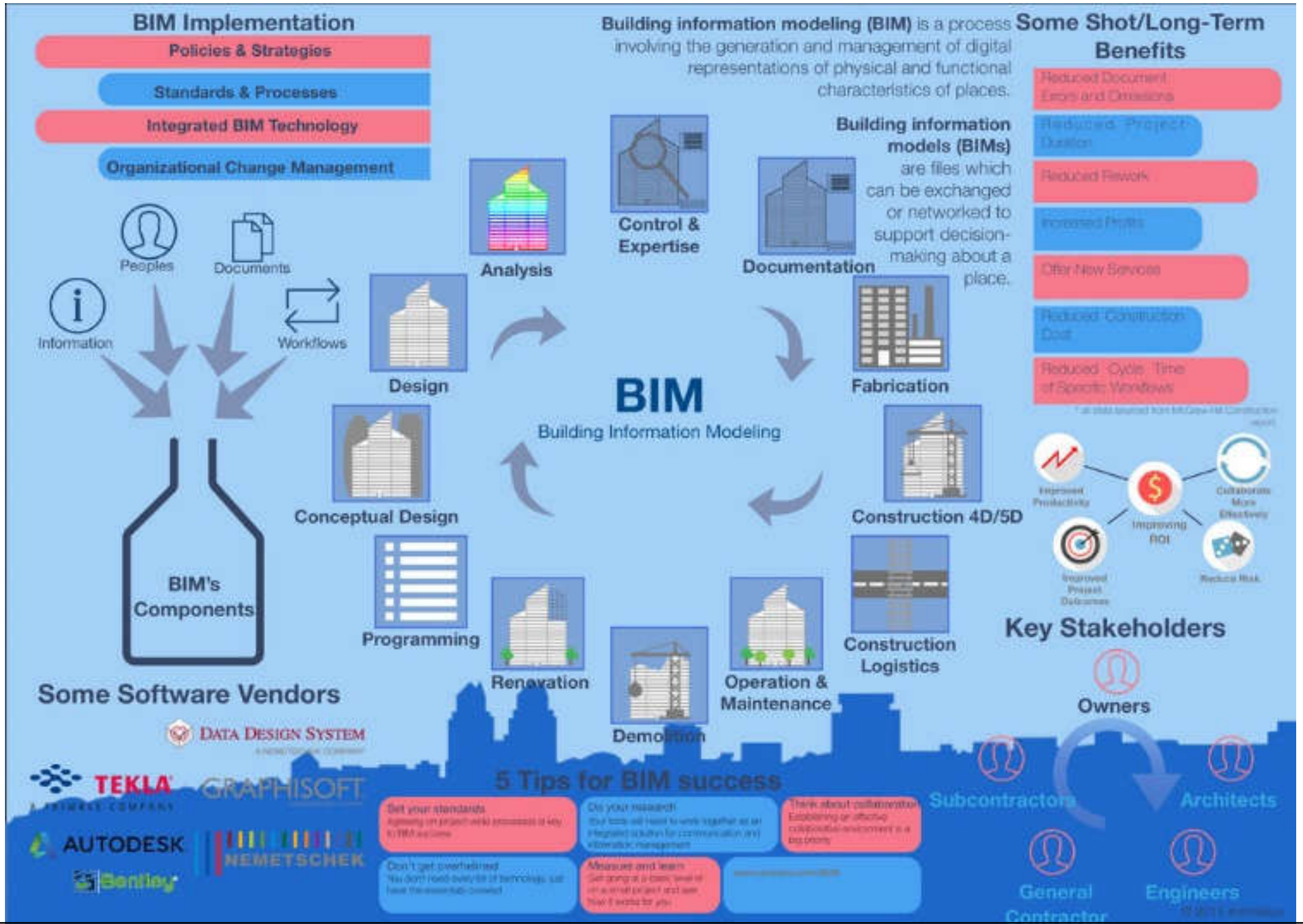

BIM maturity levels

BIM Maturity Diagram

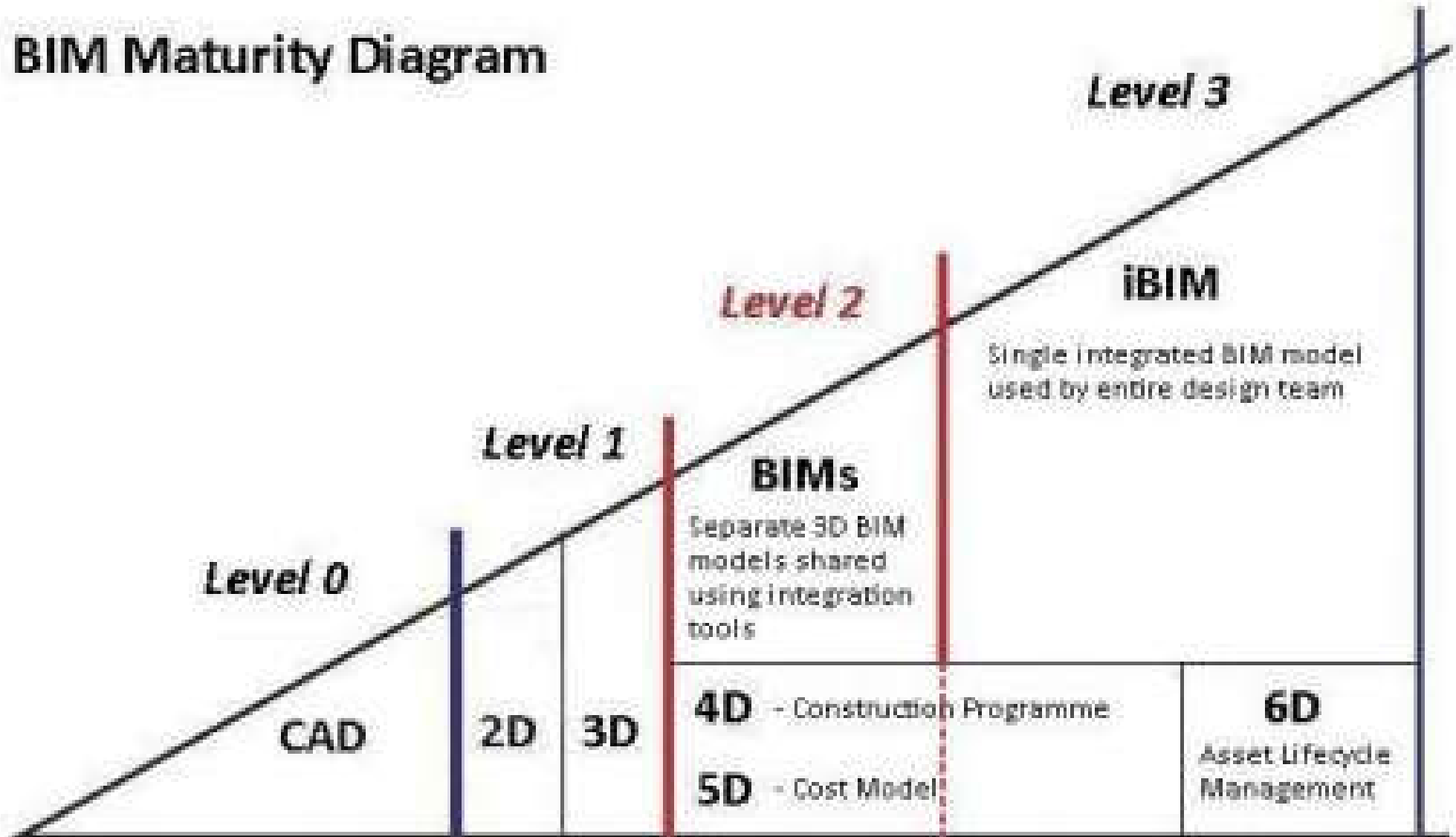

Based on Baw and Richards 2012

BIM maturity levels

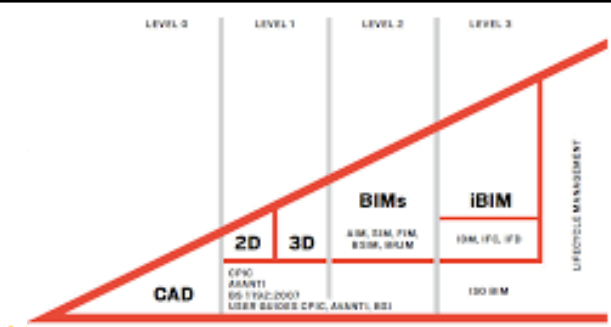

- The range of BIM maturity levels:
 - Level 0: Unmanaged CAD (Computer Aided Design)
 - Level 1: Managed CAD in 2D or 3D
 - Level 2: Managed 3D environment with data attached, but created in separate discipline models
 - Level 3: Single, online, project model with construction sequencing, cost and life-cycle management information

BIM maturity levels

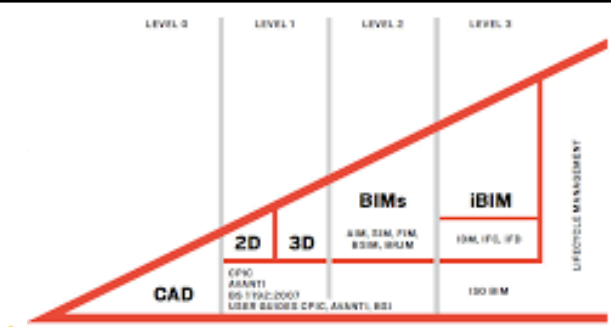

- BIM Levels explained
 - Level 0:
 - No collaboration; 2D CAD drafting only
 - Output and distribution is via paper or electronic prints, or a mixture of both
 - Level 1:
 - A mixture of 3D CAD for concept work, and 2D for drafting of statutory approval documentation and production information
 - Models are not shared between project team members

BIM maturity levels

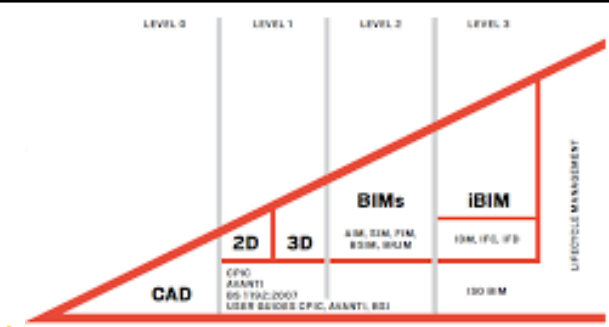

- BIM Levels explained (cont'd)

- Level 2:

- Collaborative working – all parties use their own 3D CAD models, but not necessarily working on a single, shared model
 - Design information is shared and exchanged through a common file format

- Level 3: **OPEN BIM™**

- Full collaboration between all disciplines by means of using a single, shared project model which is held in a centralized repository (also known as “Open BIM”)

BIM maturity levels

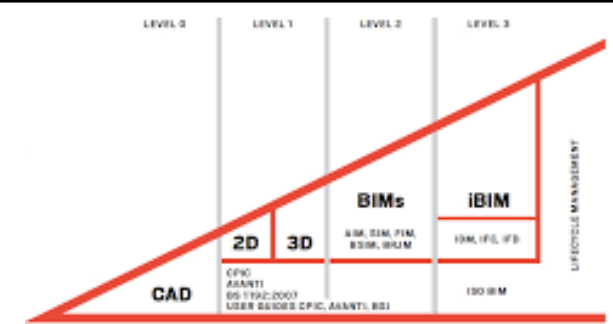

- Video: Wienerberger - What is BIM? (5:23)
 - <https://youtu.be/ZYvQk78W1Tc>
 - An brief introduction to BIM and Geo-BIM, through a short animation. The video highlights what BIM Level 2 and Level 3 entail and how these are directly influencing construction in the UK.



BIM maturity levels

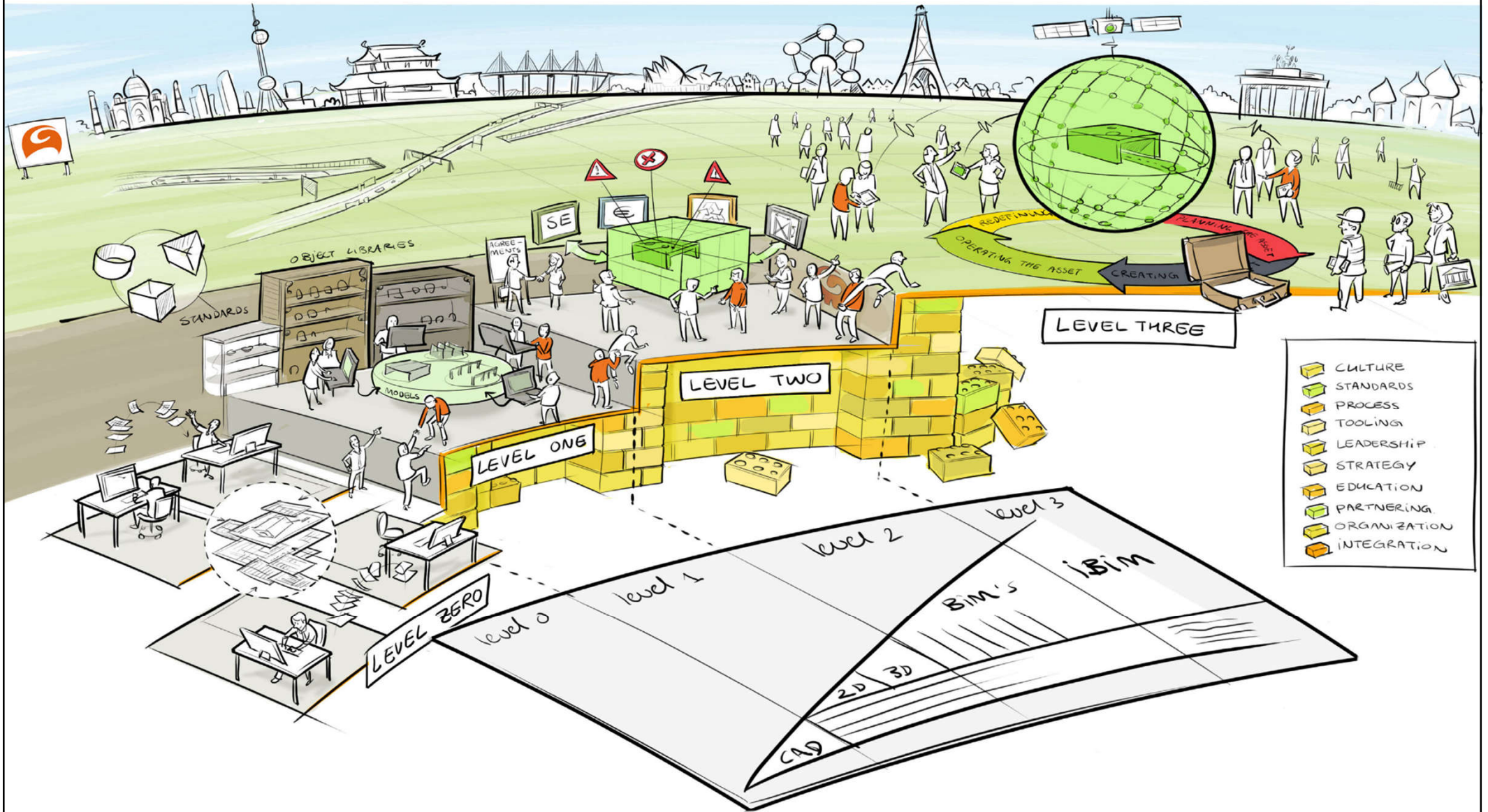

BIM maturity levels and development path in UK

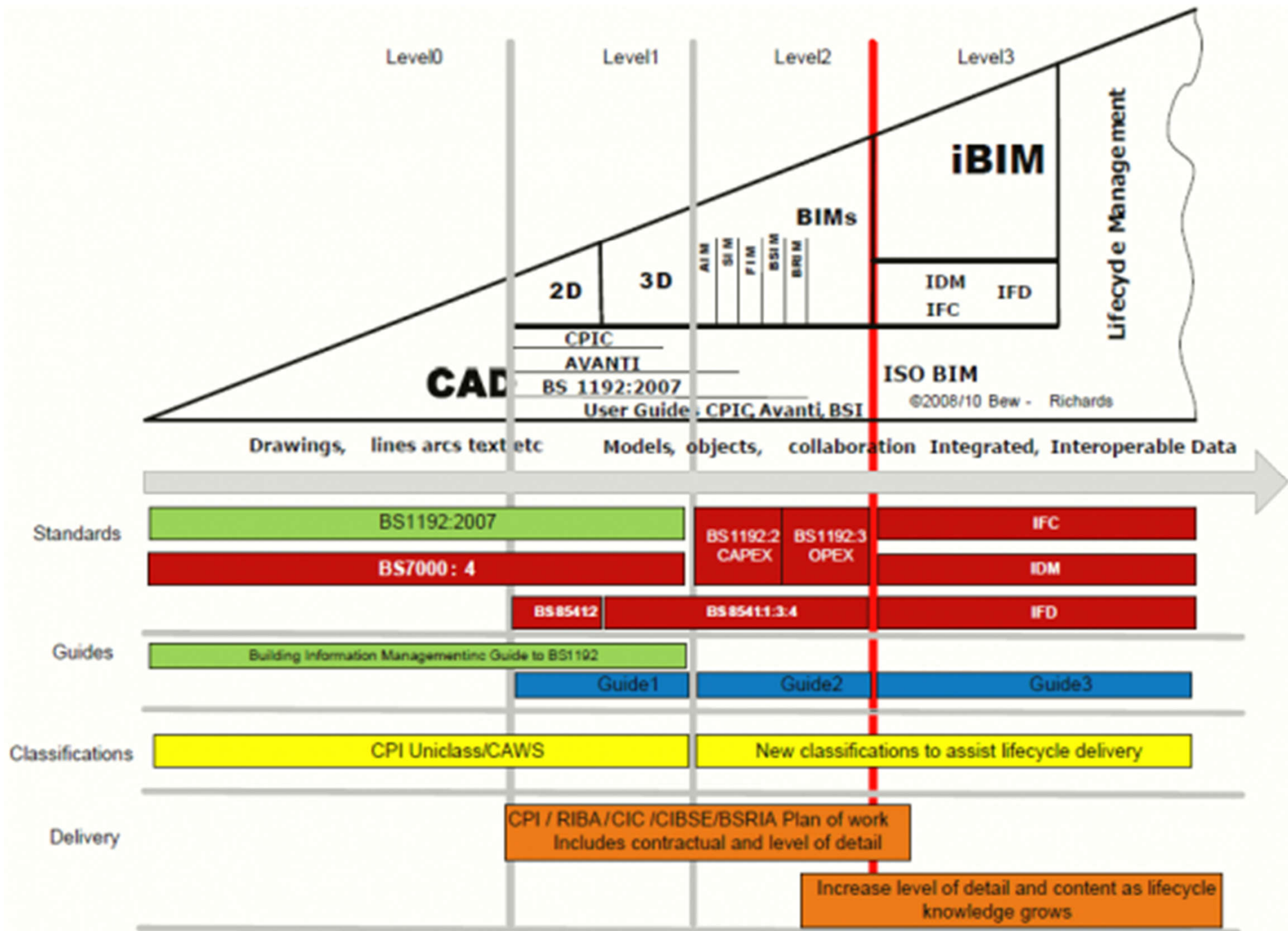

BIM maturity levels

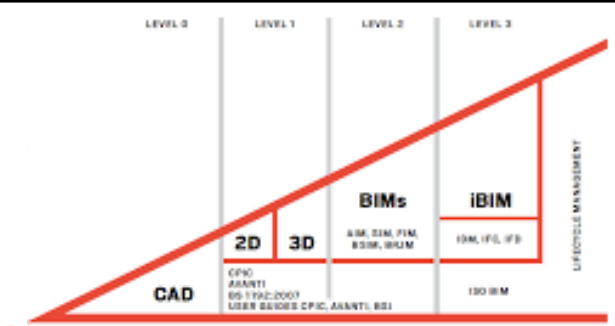

- Maturity of organisations regarding BIM:
 - Company level: object-based modelling
 - Project level: information exchange processes based on models (for collaboration)
 - Sectorial level: a global view, linked to public (procurement) policies, e.g. mandatory BIM
- Integrated Project Delivery (IPD): the long-term goal of BIM implementation

Integrated Project Delivery

*“Integrated Project Delivery (IPD) is a project delivery approach that **integrates people, systems, business structures and practices** into a process that collaboratively harnesses the talents and insights of all participants to **reduce waste** and **optimize efficiency** through all phases of design, fabrication and construction.”*



Traditional		IPD
Segmented	Teams	Integrated, collaborative
Linear, distinct, segregated	Process	Concurrent, multi-level, integrated
Individually managed	Risk	Collectively managed
Individual success, minimum effort for maximum return	Reward	Value-based, team success
Paper based, 2D, analog	Technology	Digitally based, BIM, 4D
Minimize or transfer risk, don't share	Agreements	Open sharing, collaboration, full integration
Individually focused	Education	Team-based , integrated, collaborative

BIM maturity levels

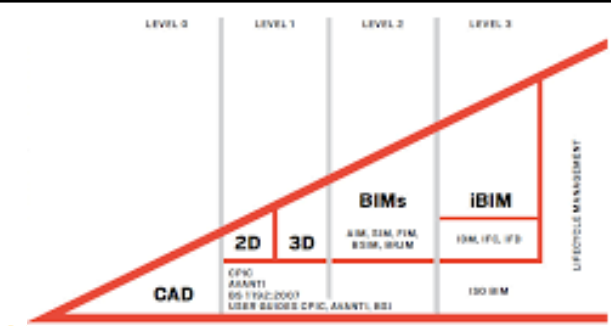

- Integrated Project Delivery (IPD) 集成項目交付
 - Involve all team members in design meetings
 - Identify key objectives up front
 - Open collaboration at all stages of a project
 - BIM is utilized
 - Minimize paper based processes and collaborate digitally
 - Check for & manage interferences with 3D clash detection
 - Set up contract mechanisms that enable and reward achievement of key objectives
 - Create a culture of trust and information sharing (win-win-win)

Level of development (LOD)

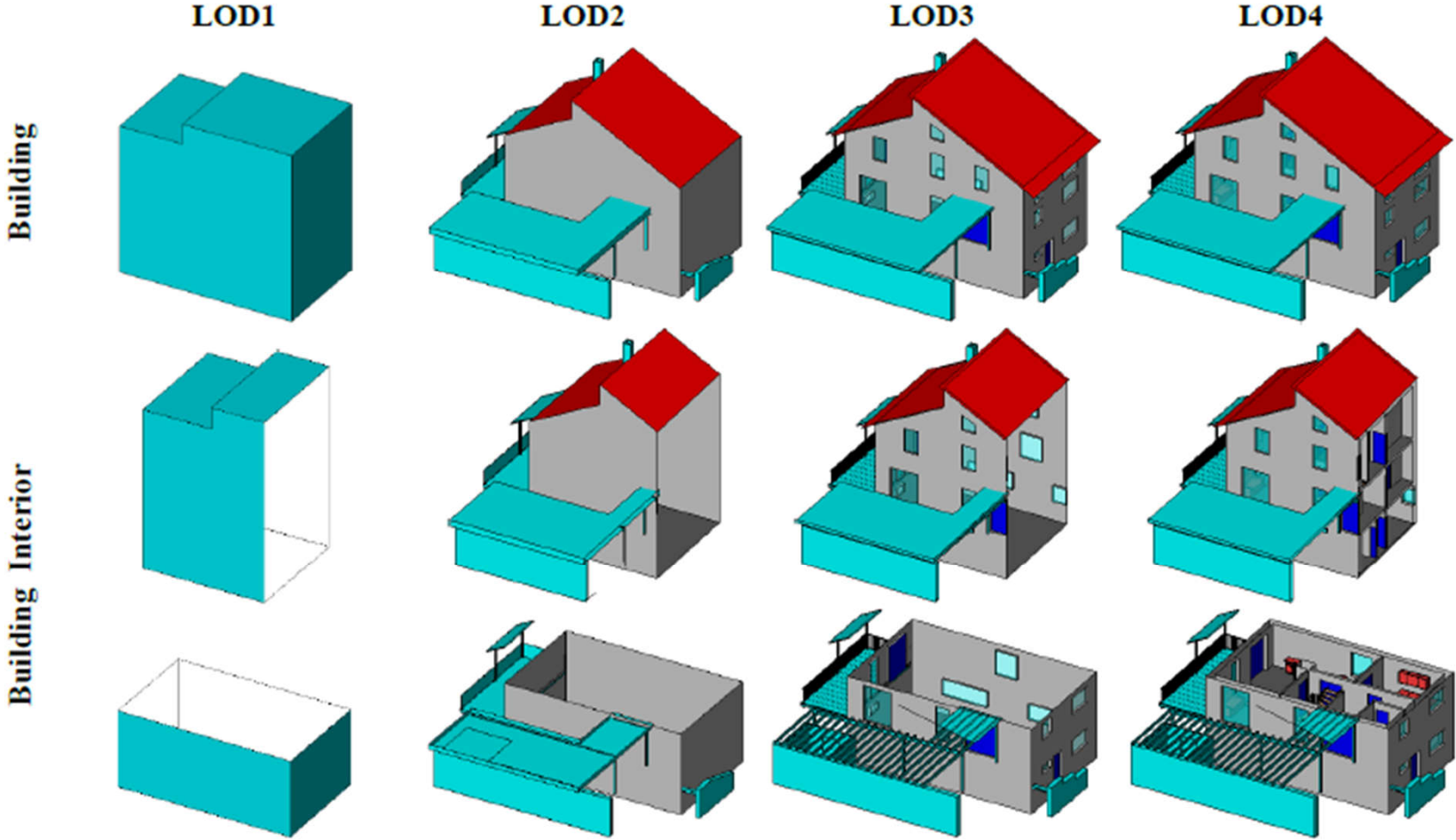

Level of development (LOD)

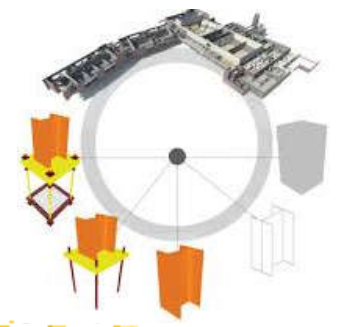

- LOD is commonly used to represent the level of precision of model content
 - This is the degree to which an element's geometry and its attached information have been thought through – the degree to which project team members may rely on the information when using the model
 - The expected LOD by element/category/building system at each stage of the project has to be determined and documented

Level of development (LOD)

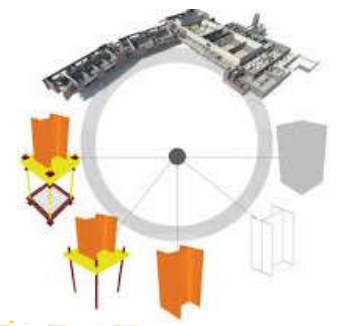

- Level of Development (LOD) specifications:
 - LOD 100: Conceptual design
 - LOD 200: Design Development
 - LOD 300: General Construction documents
 - LOD 350: The compromise
 - LOD 400: Fabrication information
 - LOD 500: As-built model

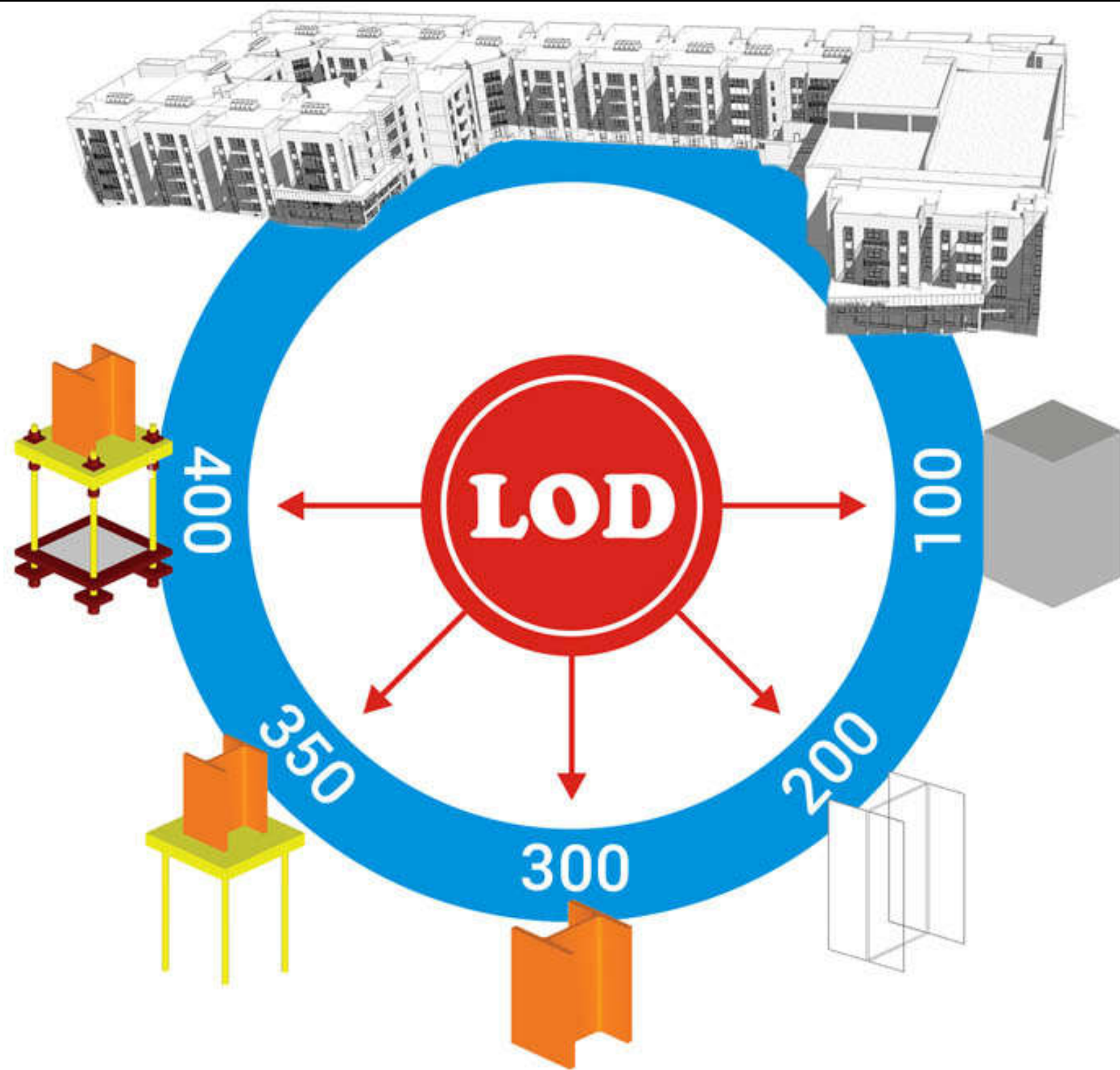

Level of development (LOD)

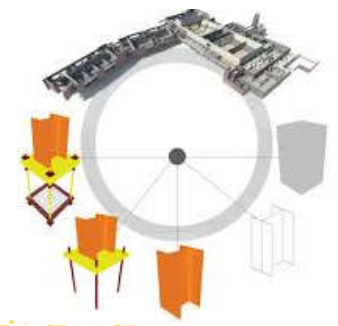

- LOD 100 elements:

- Are not geometric presentations (may be symbols or other generic representations)
- Any information derived from them must be considered approximate

- LOD 200 elements:

- Are represented graphically but are generic placeholders, e.g., volume, quantity, location, or orientation (they must be considered approximate)

Level of development (LOD)

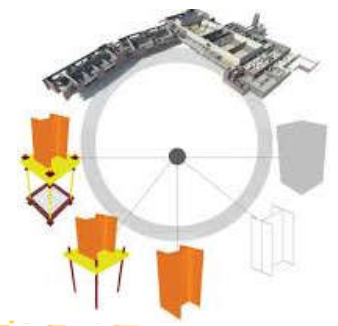

- LOD 300 elements:

- Are graphically represented as specific systems, objects, or assemblies from which quantity, shape, size, location, and orientation can be measured directly, without having to refer to non-modeled information such as notes or dimension call-outs

- LOD 350 elements:

- Are enhanced beyond LOD 300 by the addition of information regarding interfaces with other building systems

Level of development (LOD)

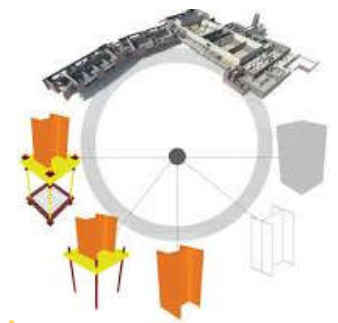

- LOD 400 elements:

- Are modeled at sufficient detail and accuracy for fabrication of the represented component

- LOD 500 element:*

- It is a field verified representation in terms of size, shape, location, quantity, and orientation
- Non-graphic information may also be attached
- * The Specification does not define or illustrate it

A piping project at various LOD levels



LOD 200

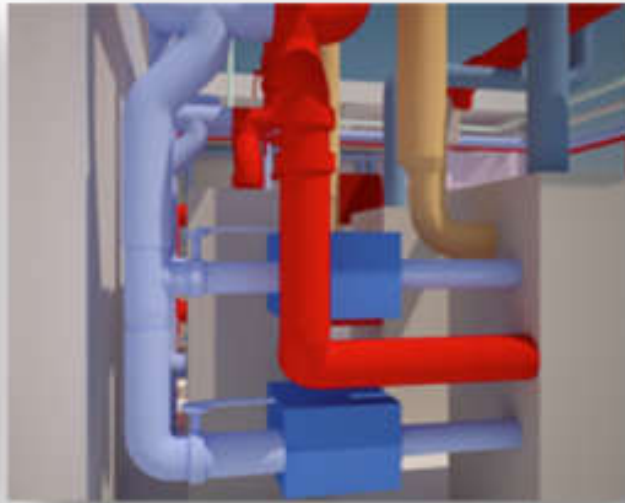

LOD 300

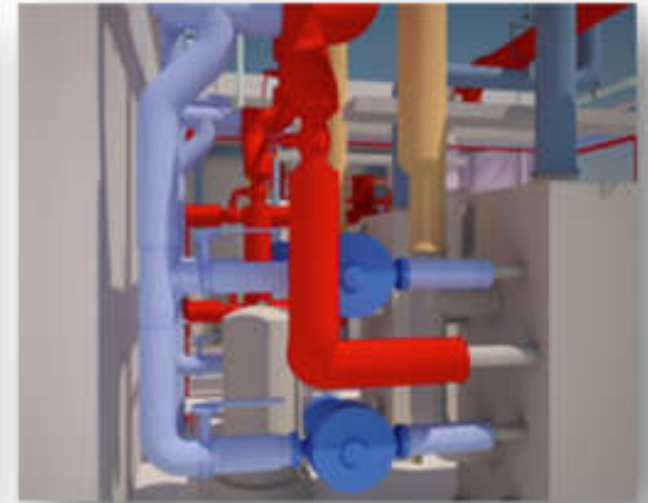

LOD 350

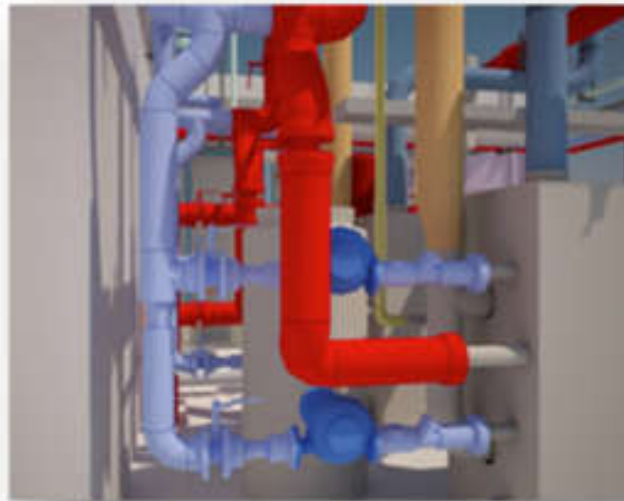

LOD 400

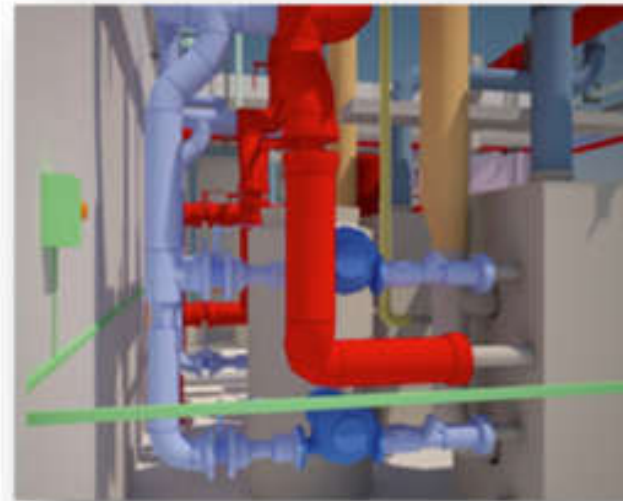

LOD 500

Level of Development (LOD): examples

LOD 100	LOD 200	LOD 300	LOD 400	LOD 500
	Remicon Glass	Ready-Mixed on Steel Glass Paint Insulation Concrete Product	Ready-Mixed on Rebar Glass Paint Insulation Concrete Product Steel	Ready-Mixed on Rebar Glass Paint Insulation Concrete Product Steel
0%	52%	95%	100%	100%
N/A	Simplicity Assesment	Detailed Assesment	Detailed Assesment	Detailed Assesment

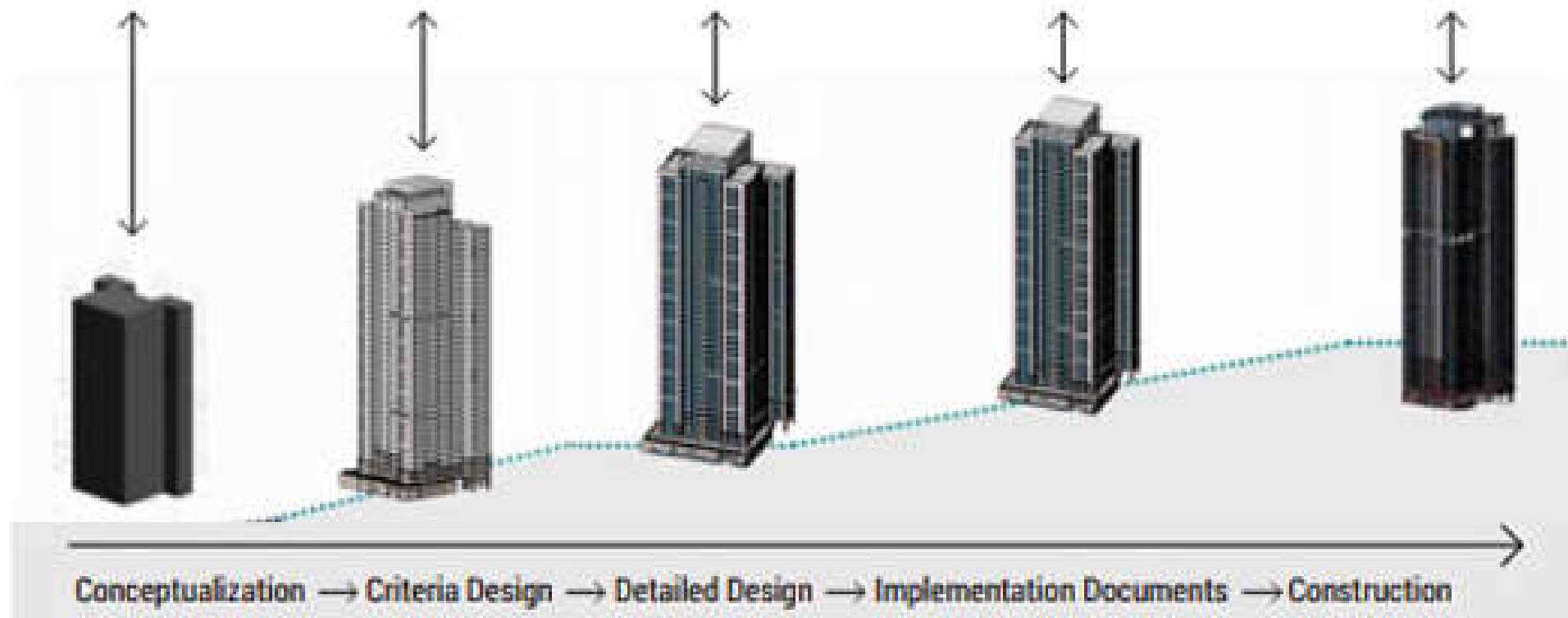

LEVEL of DEVELOPMENT

LOD 100

LOD 200

LOD 300

LOD 400

LOD 500

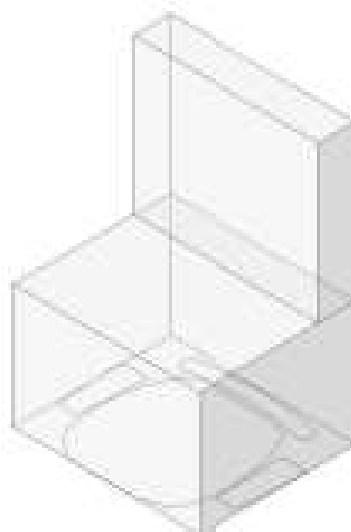

Concept (Presentation)

Design Development

Documentation

Construction

Facilities Management

<p><u>DESCRIPTION:</u> Office Chair Arms, Wheels <u>WIDTH:</u> <u>DEPTH:</u> <u>HEIGHT:</u> <u>MANUFACTURER:</u> Herman Miller, Inc. <u>MODEL:</u> Mirra <u>LOD:</u> 100</p>	<p><u>DESCRIPTION:</u> Office Chair Arms, Wheels <u>WIDTH:</u> 700 <u>DEPTH:</u> 450 <u>HEIGHT:</u> 1100 <u>MANUFACTURER:</u> Herman Miller, Inc. <u>MODEL:</u> Mirra <u>LOD:</u> 200</p>	<p><u>DESCRIPTION:</u> Office Chair Arms, Wheels <u>WIDTH:</u> 700 <u>DEPTH:</u> 450 <u>HEIGHT:</u> 1100 <u>MANUFACTURER:</u> Herman Miller, Inc. <u>MODEL:</u> Mirra <u>LOD:</u> 300</p>	<p><u>DESCRIPTION:</u> Office Chair Arms, Wheels <u>WIDTH:</u> 685 <u>DEPTH:</u> 430 <u>HEIGHT:</u> 1085 <u>MANUFACTURER:</u> Herman Miller, Inc <u>MODEL:</u> Mirra <u>LOD:</u> 400</p>	<p><u>DESCRIPTION:</u> Office Chair Arms, Wheels <u>WIDTH:</u> 685 <u>DEPTH:</u> 430 <u>HEIGHT:</u> 1085 <u>MANUFACTURER:</u> Herman Miller, Inc <u>MODEL:</u> Mirra <u>PURCHASE DATE:</u> 01/02/2013</p>
--	--	--	---	--

(Only data in red is useable)

Level of development (LOD)

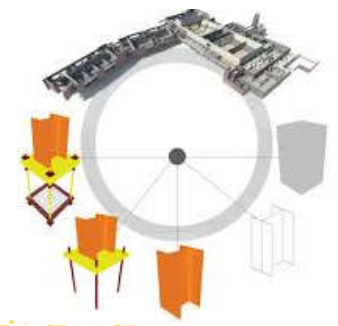

- Level of Development vs. Level of Detail
 - Level of Detail (LoD) is essentially how much detail is included in the model element
 - Level of Development (LOD) is the degree to which the element's geometry and attached information has been thought through
 - Level of Detail can be thought of as input to the element, while Level of Development is reliable output
 - Levels of (model) information (LOI), which relates to the non-graphical content of models

Level of Development (LOD) vs. Level of Detail (LoD)

LOD

Level of Development

LoD

Level of Detail

LOI

Level of Information

+

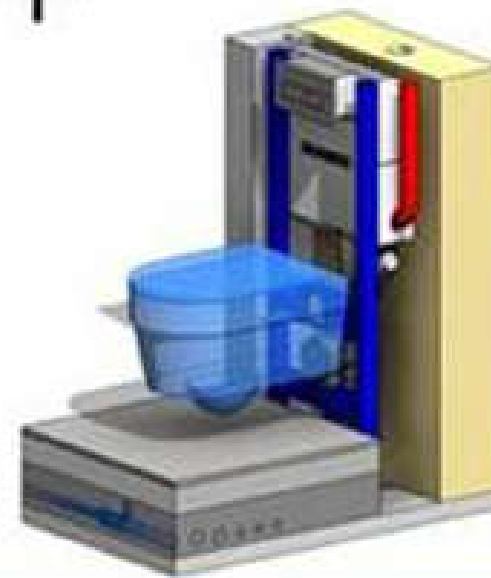
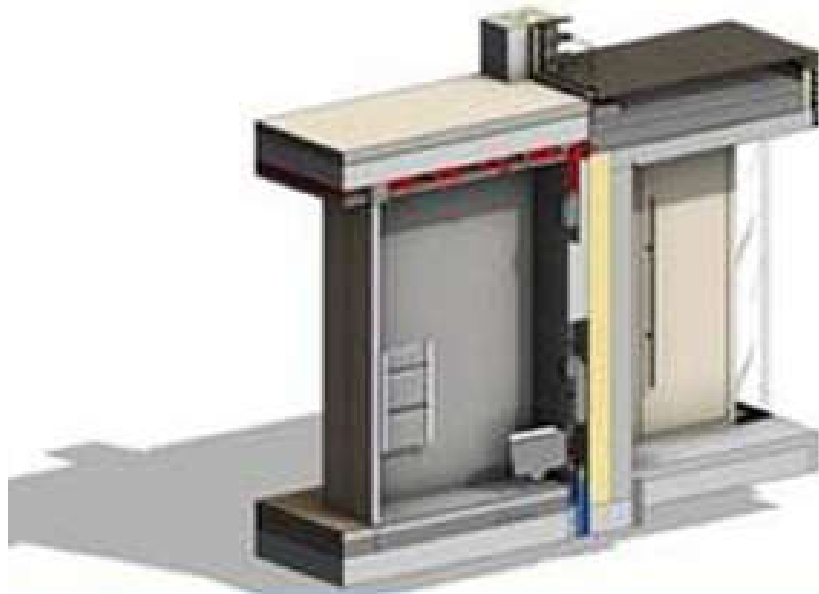



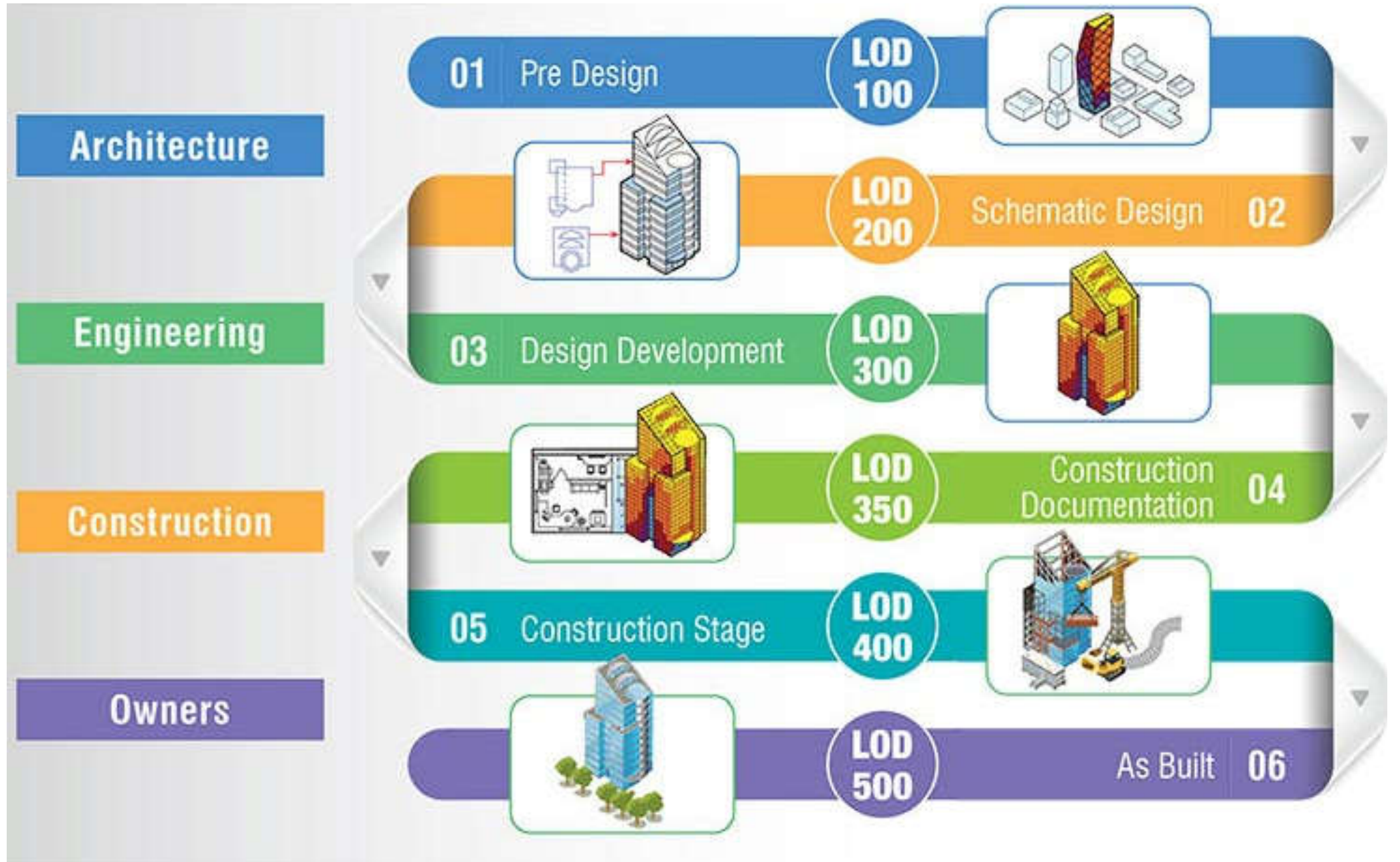

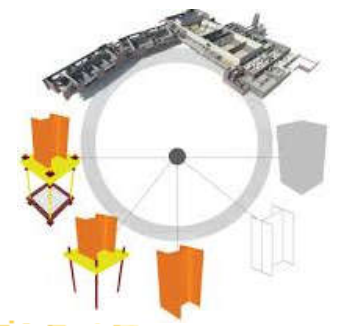

Level of Development (LOD) and building development process



Level of development (LOD)

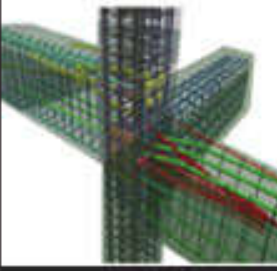

- LOD in the design and construction process:
 - 1. Element-oriented modelling
 - As-Built (LOD 500)
 - Fabrication and assembly (LOD 400)
 - 2. System/Component oriented modelling
 - Detailed design (LOD 300)
 - Basic design (LOD 200)
 - 3. Conceptual information model
 - Conceptual design (LOD 100)
 - Client requirements (Pre-modelling)

Element-Oriented Modeling	As-Built	LOD 500		<div style="display: flex; flex-wrap: wrap; justify-content: space-around;"> <div style="border: 1px solid black; border-radius: 10px; padding: 5px; margin: 5px;">Operation</div> <div style="border: 1px solid black; border-radius: 10px; padding: 5px; margin: 5px;">Budget</div> <div style="border: 1px solid black; border-radius: 10px; padding: 5px; margin: 5px;">Occupancy</div> <div style="border: 1px solid black; border-radius: 10px; padding: 5px; margin: 5px;">Capacity</div> <div style="border: 1px solid black; border-radius: 10px; padding: 5px; margin: 5px;">Location</div> <div style="border: 1px solid black; border-radius: 10px; padding: 5px; margin: 5px;">LEED Class</div> </div>																			
	Fabrication and Assembly	LOD 400		<div style="display: flex; flex-wrap: wrap; justify-content: space-around;"> <div style="border: 1px solid black; border-radius: 10px; padding: 5px; margin: 5px;">Shape Areas Volumes</div> <div style="border: 1px solid black; border-radius: 10px; padding: 5px; margin: 5px;">Number of Levels Structural System</div> <div style="border: 1px solid black; border-radius: 10px; padding: 5px; margin: 5px;">Mechanical Systems Electrical Systems</div> </div>																			
System \ Component Oriented Modeling	Detailed Design	LOD 300		<table border="1" style="border-collapse: collapse;"> <tr> <td rowspan="3" style="writing-mode: vertical-rl; transform: rotate(180deg);">Component 1 Basement Space</td> <td>Geometry</td> <td>G1</td> <td>G2</td> <td>-</td> <td rowspan="3" style="font-size: 2em;">}</td> <td rowspan="3" style="vertical-align: middle;">Component Attributes</td> </tr> <tr> <td>Position</td> <td>P1</td> <td>P2</td> <td>-</td> </tr> <tr> <td>Specification</td> <td>S1</td> <td>S2</td> <td>-</td> </tr> </table>	Component 1 Basement Space	Geometry	G1	G2	-	}	Component Attributes	Position	P1	P2	-	Specification	S1	S2	-				
	Component 1 Basement Space	Geometry	G1	G2		-	}	Component Attributes															
Position		P1	P2	-																			
Specification		S1	S2	-																			
Basic Design	LOD 200		<div style="display: flex; justify-content: space-around;"> <table border="1" style="border-collapse: collapse;"> <tr> <td rowspan="3" style="writing-mode: vertical-rl; transform: rotate(180deg);">Comp. 1.1 Basement Wall</td> <td>Geo.</td> <td>G1</td> <td>-</td> </tr> <tr> <td>Pos.</td> <td>P1</td> <td>-</td> </tr> <tr> <td>Spc.</td> <td>S1</td> <td>-</td> </tr> </table> <table border="1" style="border-collapse: collapse;"> <tr> <td rowspan="3" style="writing-mode: vertical-rl; transform: rotate(180deg);">Comp. 1.2 Basement Floor Slab</td> <td>Geo.</td> <td>G1</td> <td>-</td> </tr> <tr> <td>Pos.</td> <td>P1</td> <td>-</td> </tr> <tr> <td>Spc.</td> <td>S1</td> <td>-</td> </tr> </table> </div> <p style="text-align: center; color: red;">Inter-model Dependency</p>	Comp. 1.1 Basement Wall	Geo.	G1	-	Pos.	P1	-	Spc.	S1	-	Comp. 1.2 Basement Floor Slab	Geo.	G1	-	Pos.	P1	-	Spc.	S1	-
Comp. 1.1 Basement Wall	Geo.	G1	-																				
	Pos.	P1	-																				
	Spc.	S1	-																				
Comp. 1.2 Basement Floor Slab	Geo.	G1	-																				
	Pos.	P1	-																				
	Spc.	S1	-																				
Conceptual Information Model	Conceptual Design	LOD 100		<div style="display: flex; justify-content: space-around;"> <table border="1" style="border-collapse: collapse;"> <tr> <td rowspan="3" style="writing-mode: vertical-rl; transform: rotate(180deg);">C. 1.1.1 Wall Formwork</td> <td>G</td> <td>-</td> </tr> <tr> <td>P</td> <td>-</td> </tr> <tr> <td>S</td> <td>-</td> </tr> </table> <table border="1" style="border-collapse: collapse;"> <tr> <td rowspan="3" style="writing-mode: vertical-rl; transform: rotate(180deg);">C. 1.1.2 Wall Rein. Bar</td> <td>G</td> <td>-</td> </tr> <tr> <td>P</td> <td>-</td> </tr> <tr> <td>S</td> <td>-</td> </tr> </table> </div> <p style="text-align: center; color: green;">Inter-model Dependency</p>	C. 1.1.1 Wall Formwork	G	-	P	-	S	-	C. 1.1.2 Wall Rein. Bar	G	-	P	-	S	-					
	C. 1.1.1 Wall Formwork	G	-																				
P		-																					
S		-																					
C. 1.1.2 Wall Rein. Bar	G	-																					
	P	-																					
	S	-																					
Client Requirements	Pre-Modeling		<div style="display: flex; justify-content: space-around;"> <table border="1" style="border-collapse: collapse;"> <tr> <td rowspan="3" style="writing-mode: vertical-rl; transform: rotate(180deg);">C. 1.2.2 Floor Slab Rein. Bar</td> <td>G</td> <td>-</td> </tr> <tr> <td>P</td> <td>-</td> </tr> <tr> <td>S</td> <td>-</td> </tr> </table> <table border="1" style="border-collapse: collapse;"> <tr> <td rowspan="3" style="writing-mode: vertical-rl; transform: rotate(180deg);">C. 1.2.1 Floor Slab Formwork</td> <td>G</td> <td>-</td> </tr> <tr> <td>P</td> <td>-</td> </tr> <tr> <td>S</td> <td>-</td> </tr> </table> </div>	C. 1.2.2 Floor Slab Rein. Bar	G	-	P	-	S	-	C. 1.2.1 Floor Slab Formwork	G	-	P	-	S	-						
C. 1.2.2 Floor Slab Rein. Bar	G	-																					
	P	-																					
	S	-																					
C. 1.2.1 Floor Slab Formwork	G	-																					
	P	-																					
	S	-																					