

IBTM5660 Utility Services

<http://ibse.hk/IBTM5660/>



Steam Systems

Ir Dr. Sam C. M. Hui

E-mail: sam.cmhui@gmail.com

<http://ibse.hk/cmhui/>

Jan 2023

Contents



- Properties of steam
- Uses of steam
- Steam system
- Steam traps
- Steam boilers
- Design considerations
- Steam pipeline
- Condensate recovery



Properties of steam



- Basic principles

- Steam: water heated to vaporisation
- At atmospheric pressure, temperature = 100 °C

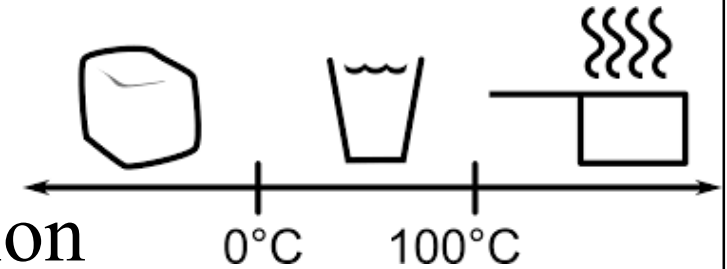

- Three types of heat in **steam** calculation:

- Specific heat (capacity) of water (c_{pw}) = 4.2 kJ/kg.K
- Specific enthalpy of evaporation (h_{fg})
- Specific enthalpy of steam (h_g)

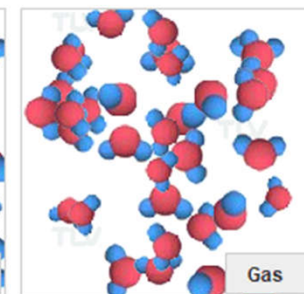
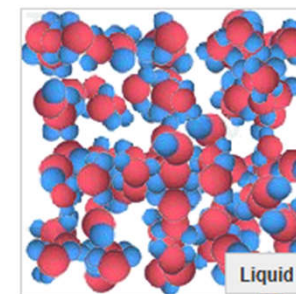

Properties of steam



- Heat transfer
 - Latent heat of evaporation = 2257 kJ/kg at atm pressure (condensable energy content)
 - Sensible heat of water = 419 kJ/kg (0 to 100 °C)
- Flow at high velocity (24-36 m/s) and high temperature (100-198 °C)

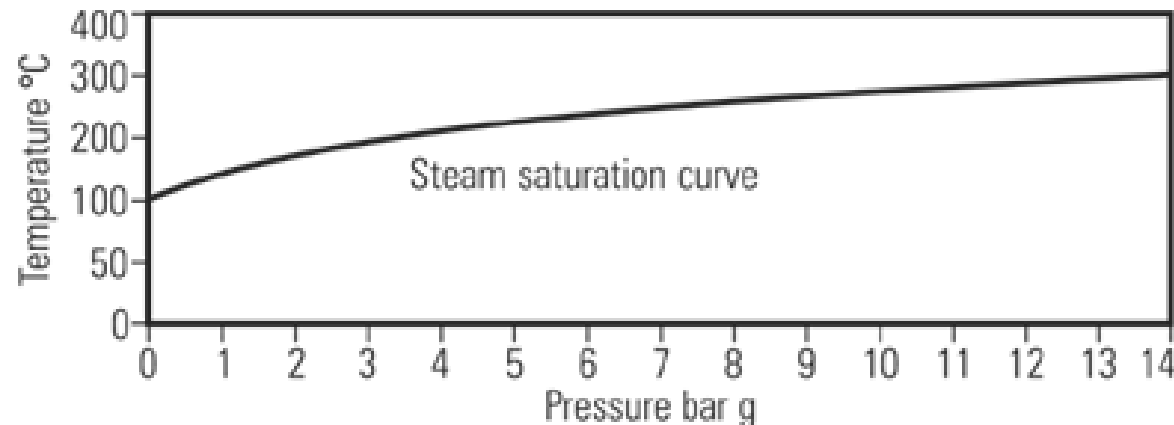

Properties of steam



- Assume you understand the basics well
 - Such as pressure, specific volume, density, temperature, internal energy, enthalpy, entropy and specific heat
 - Review relevant textbooks if you have questions
- Key fundamental concepts
 - Steam tables
 - Dry steam and wet steam
 - Superheated steam

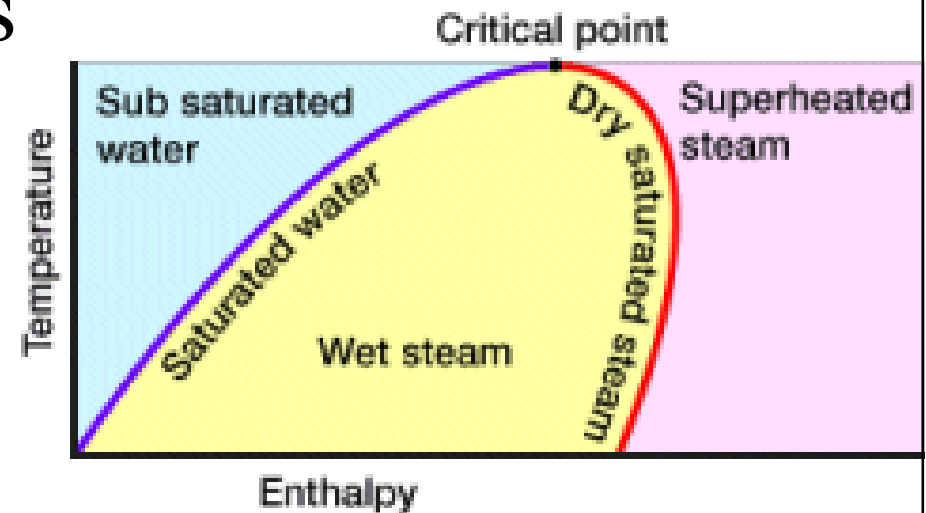

Properties of steam



- Steam tables

- To determine various steam properties
 - Pressure (absolute or gauge) [1 bar = 100 kPa = 14.5 psi]
 - Temperature [$^{\circ}\text{C}$ or K]
 - Specific enthalpy [kJ/kg]
 - Specific volume (inverse of density) [m^3/kg]
 - Specific heat capacity [kJ/kg.K]
- Published tables in databooks, such as CIBSE Guide C, Section 4, or IOP Guide
- Total enthalpy, $h_g = h_f$ (sensible) + h_{fg} (latent)

Do you know how to use these steam tables?

Extract from the saturated steam tables

Pressure bar g	Saturation temperature °C	Enthalpy kJ/kg			Volume of dry saturated steam m ³ /kg
		Water h _f	Evaporation h _{fg}	Steam h _g	
0	100	419	2 257	2 676	1.673
1	120	508	2 201	2 707	0.881
2	134	562	2 163	2 725	0.603
3	144	605	2 133	2 738	0.461
4	152	641	2 108	2 749	0.374
5	159	671	2 086	2 757	0.315
6	165	697	2 066	2 763	0.272
7	170	721	2 048	2 769	0.240

Extract from superheated steam tables

Absolute pressure bar a	Units	Temperature (°C)					
		150	200	250	300	400	500
1.013	v _g (m ³ /kg)	1.912	2.145	2.375	2.604	3.062	3.519
	u _g (kJ/kg)	2 583	2 659	2 734	2 811	2 968	3 131
	h _g (kJ/kg)	2 777	2 876	2 975	3 075	3 278	3 488
	s _g (kJ/kg)	7.608	7.828	8.027	8.209	8.537	8.828

The enthalpy/pressure diagram

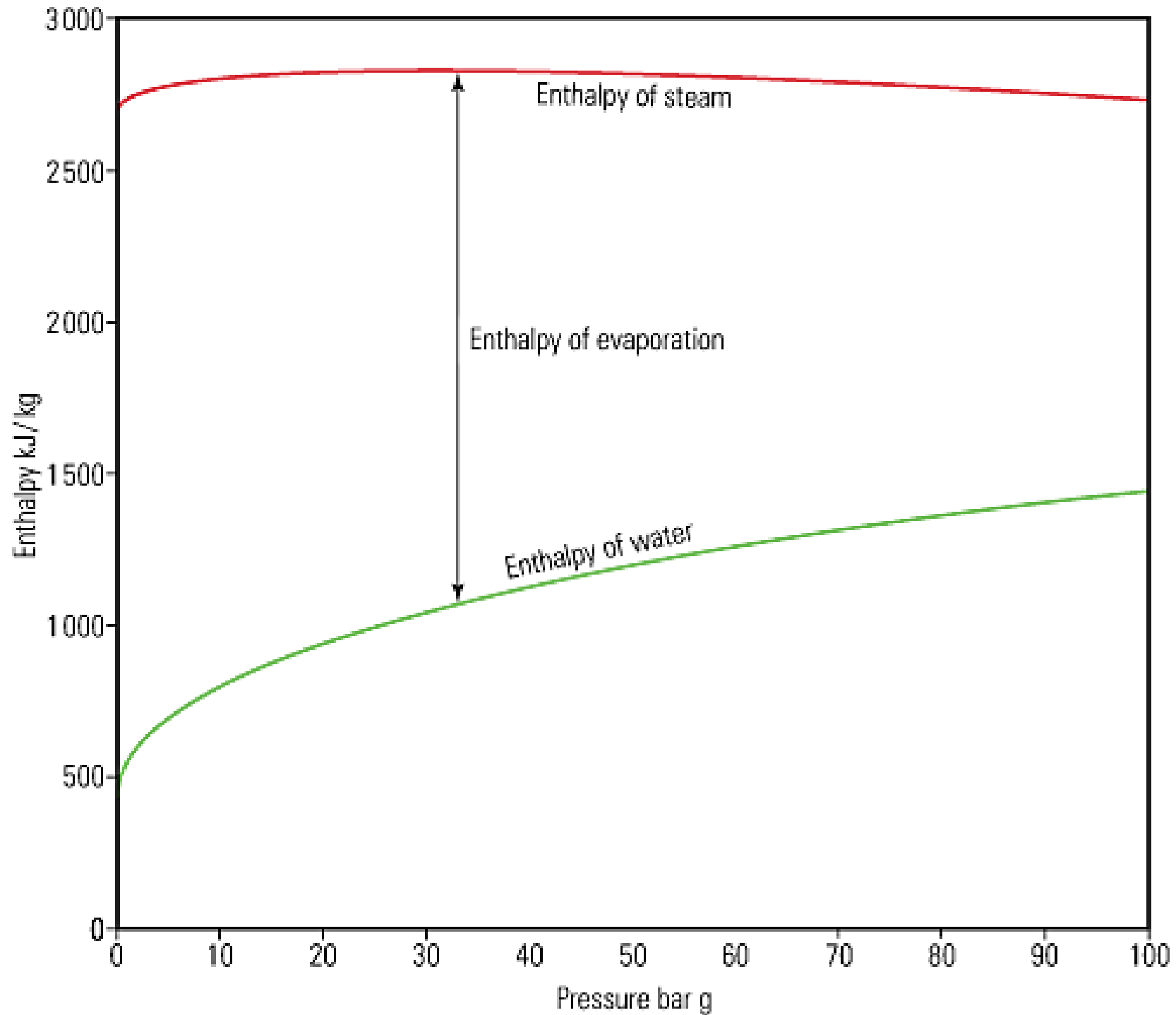

Properties of steam



- Types of steam:
 - Saturated steam (Dry)
 - Unsaturated steam (Wet) (with non-vaporized water molecules)
 - Superheated steam (above the saturation curve)
 - Supercritical water (exceeds its critical point)
- Flash steam
 - The steam formed from hot condensate when the pressure is reduced

Pressure-temperature relationship of water & steam

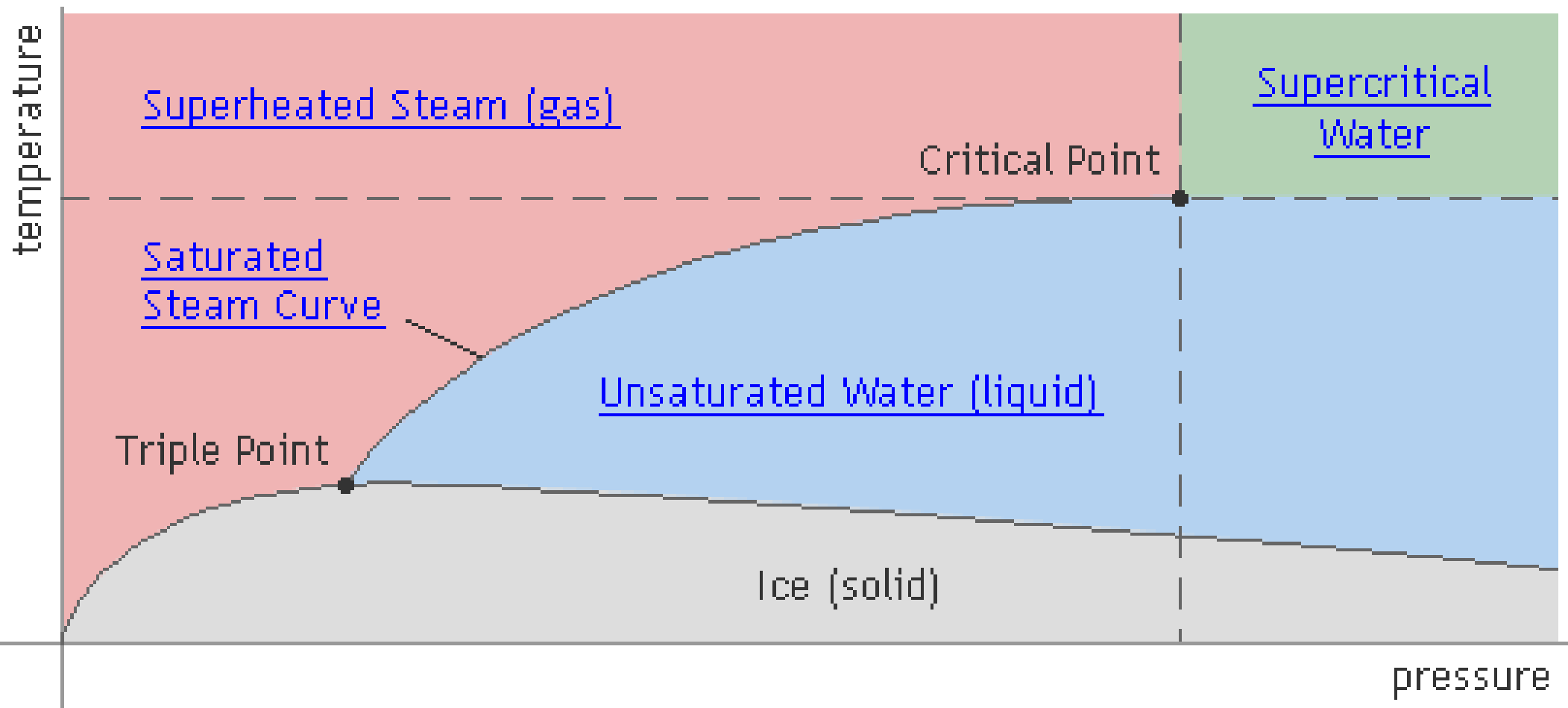

Can you explain the relationship & the points?

Triple Point : 0°C, 0.61 KPa abs (32°F, 0.09 psia)
Critical Point : 374°C, 22.1 MPa abs (705°F, 3208 psia)

Properties of steam



- Dryness of steam

- Steam often carries tiny droplets of water
- *Dryness fraction* (χ) = proportion of completely dry steam present in the steam-moisture mixture
- Wet steam has a heat content much lower than that of dry saturated steam at the same pressure
 - Actual enthalpy of evaporation = $h_{fg} \cdot (\chi)$
 - Actual total enthalpy = $h_f + h_{fg} \cdot (\chi)$

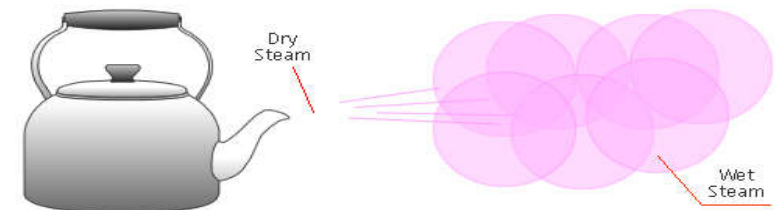

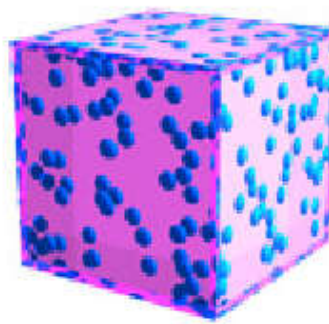
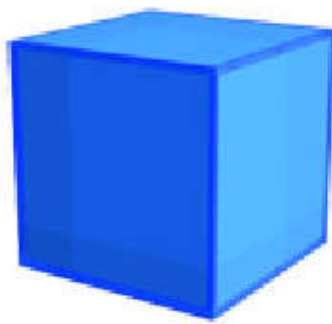

Saturated Water (0% Dryness)
 Temperature: 100 °C [212 °F]
 Total Heat: $h_f + 0\% \cdot h_{fg}$
 = 419 kJ/kg [180 BTU/lb]

Wet Steam (x% Dryness)
 Temperature: 100 °C [212 °F]
 Total Heat: $h_f + x\% \cdot h_{fg}$
 < 2676 kJ/kg [1150 BTU/lb]

Saturated Steam (100% Dryness)
 Temperature: 100 °C [212 °F]
 Total Heat: $h_f + 100\% \cdot h_{fg}$
 = 2676 kJ/kg [1150 BTU/lb]

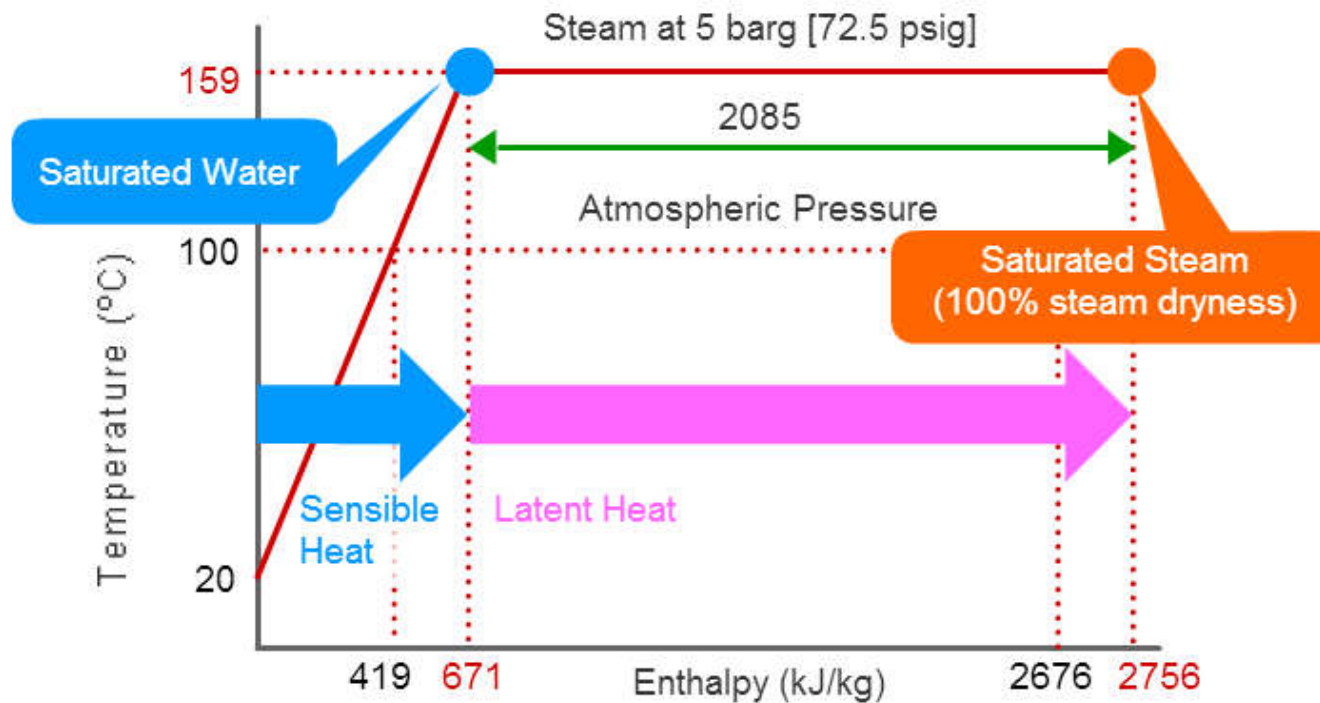

The relationship between steam dryness and enthalpy

Steam Table (abs)

P (bar)	T (°C)	(m ³ /kg)		(kJ/kg)		
		v_f	v_g	h_f	h_{fg}	h_g
1	100	0.00104	1.673	419	2257	2676
6	159	0.00110	0.3213	671	2085	2756

(See also: <https://www2.tlv.com/en-au/steam-info/steam-theory/steam-basics/wet-steam-dry-steam>)

Properties of steam



- Superheated steam

- If the saturated steam produced in a boiler is exposed to a surface with a higher temperature, its temperature will increase above the evaporating temperature → Superheated
- When superheated steam gives up some of its enthalpy, a fall in temperature without condensation until the saturation temperature has been reached (condensation occurs in saturated steam)

The temperature/enthalpy diagram

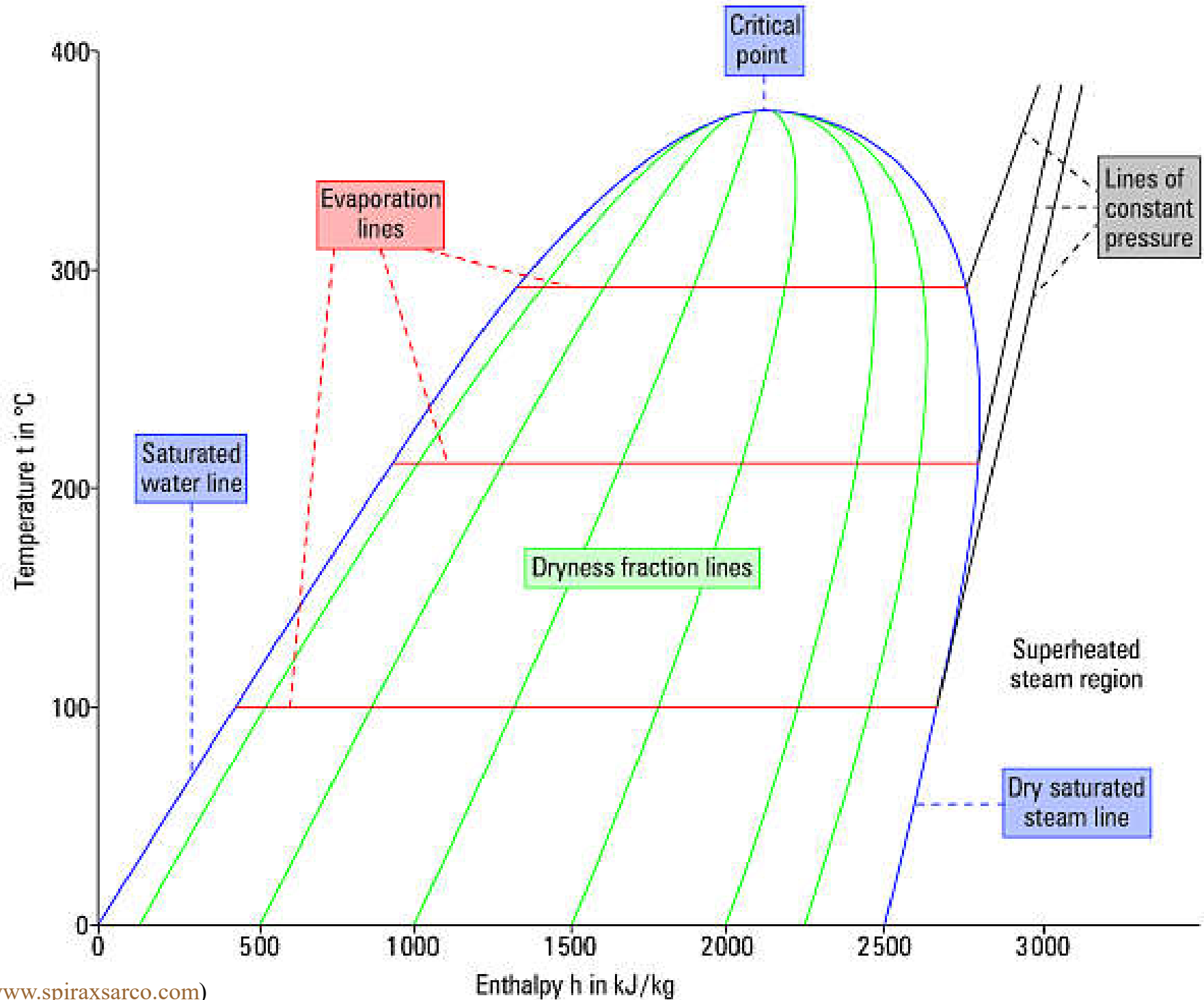

Uses of steam

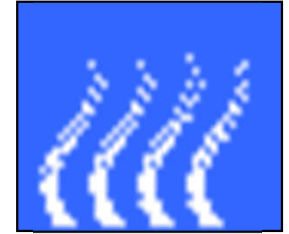

- **Steam** is used:

- To produce electrical power in power plants
- As a heating medium for industrial process, heating & hot water in buildings, cooking
- To provide chilled water using waste heat



- Common applications in buildings:

- As a primary medium for distributing heat in factories, hospitals and hotels
- Means of sterilizing, cooking (Chinese restaurants)
- Space heating, humidifying air, hot water supply



Industries and processes which use steam

Heavy users	Medium users	Light users
Food and drinks Pharmaceuticals Oil refining Chemicals Plastics Pulp and paper Sugar refining Textiles Metal processing Rubber and tyres Shipbuilding Power generation	Heating and ventilating Cooking Curing Chilling Fermenting Treating Cleaning Melting Baking Drying	Electronics Horticulture Air conditioning Humidifying

Uses of steam

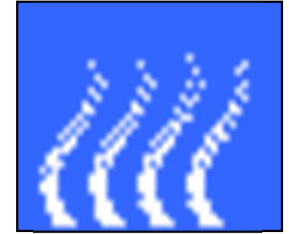

- **Steam** as a source of **heat**:

- Direct steam heating



- Processes where steam is in direct contact with the product being heated, e.g. steam Chinese dumplings

- Indirect steam heating



Jacketed kettle

- Processes where steam is not in direct contact with the product being heated; widely used in industry (with a heat exchanger) because it provides rapid, even heating
- The water droplets formed during heating will not affect the product

Direct and indirect steam heating

Process in which steam is in direct contact with the product being heated

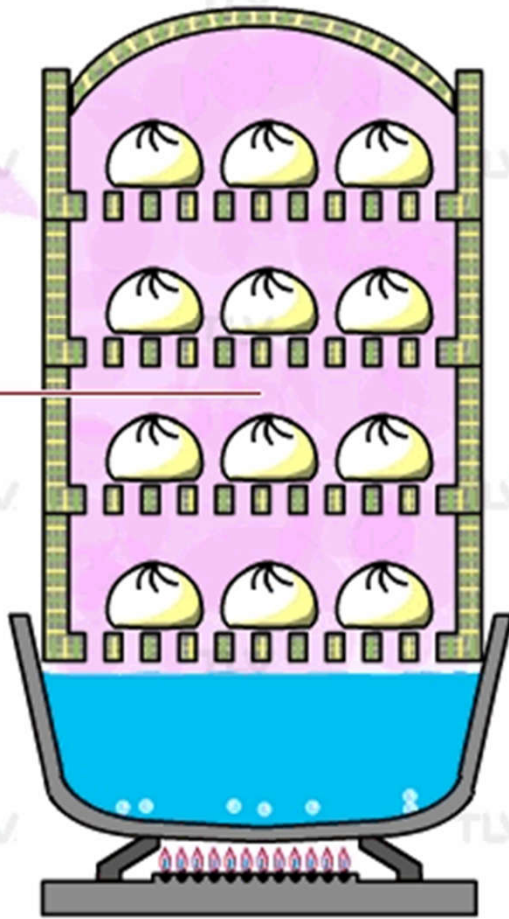

Wet steam forms when steam comes into contact with the cooler surrounding atmosphere

Chinese dumplings being steamed directly

Product being heated indirectly

Steam is supplied to the inside of the jacketed kettle

Water droplets are not a concern because the product is heated indirectly using a heat exchanger

Having transferred its latent heat to the product, the steam turns into condensate and is discharged

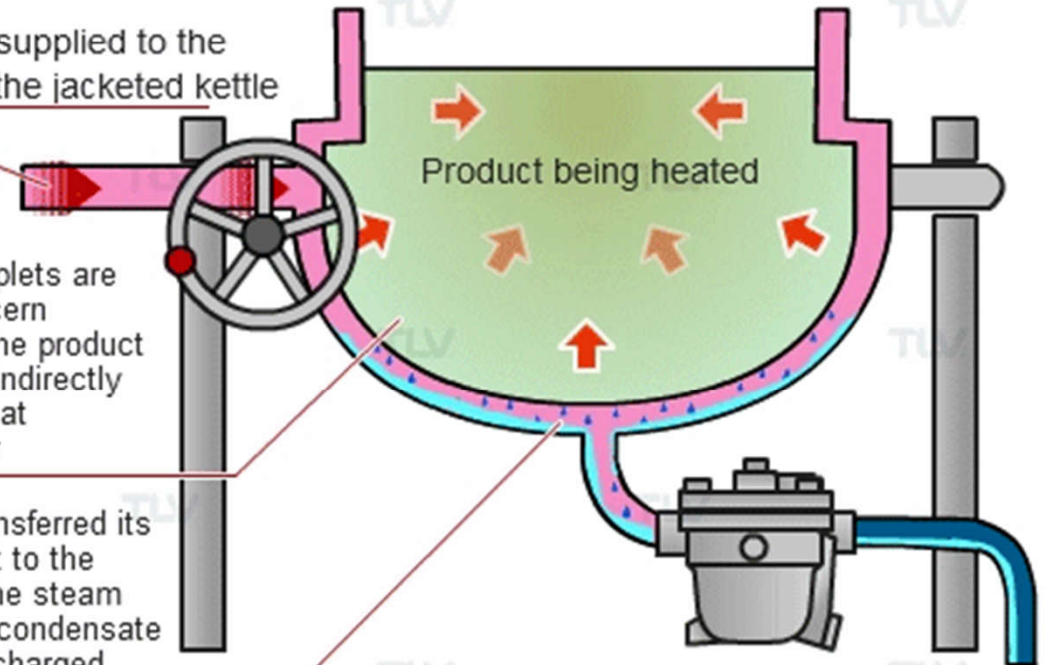

Heating application of steam using a shell and tube heat exchanger

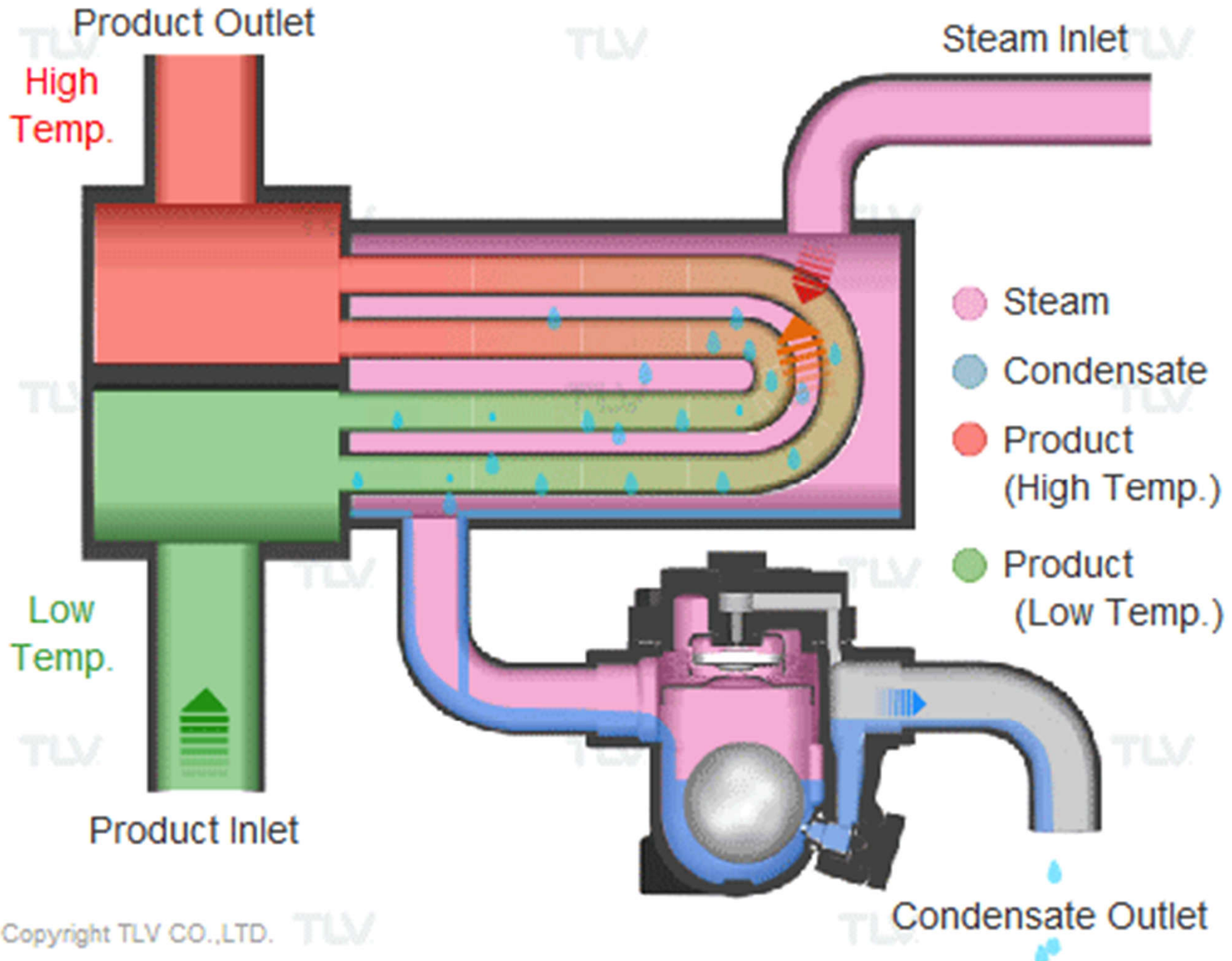

Ducted air system with air heater batteries

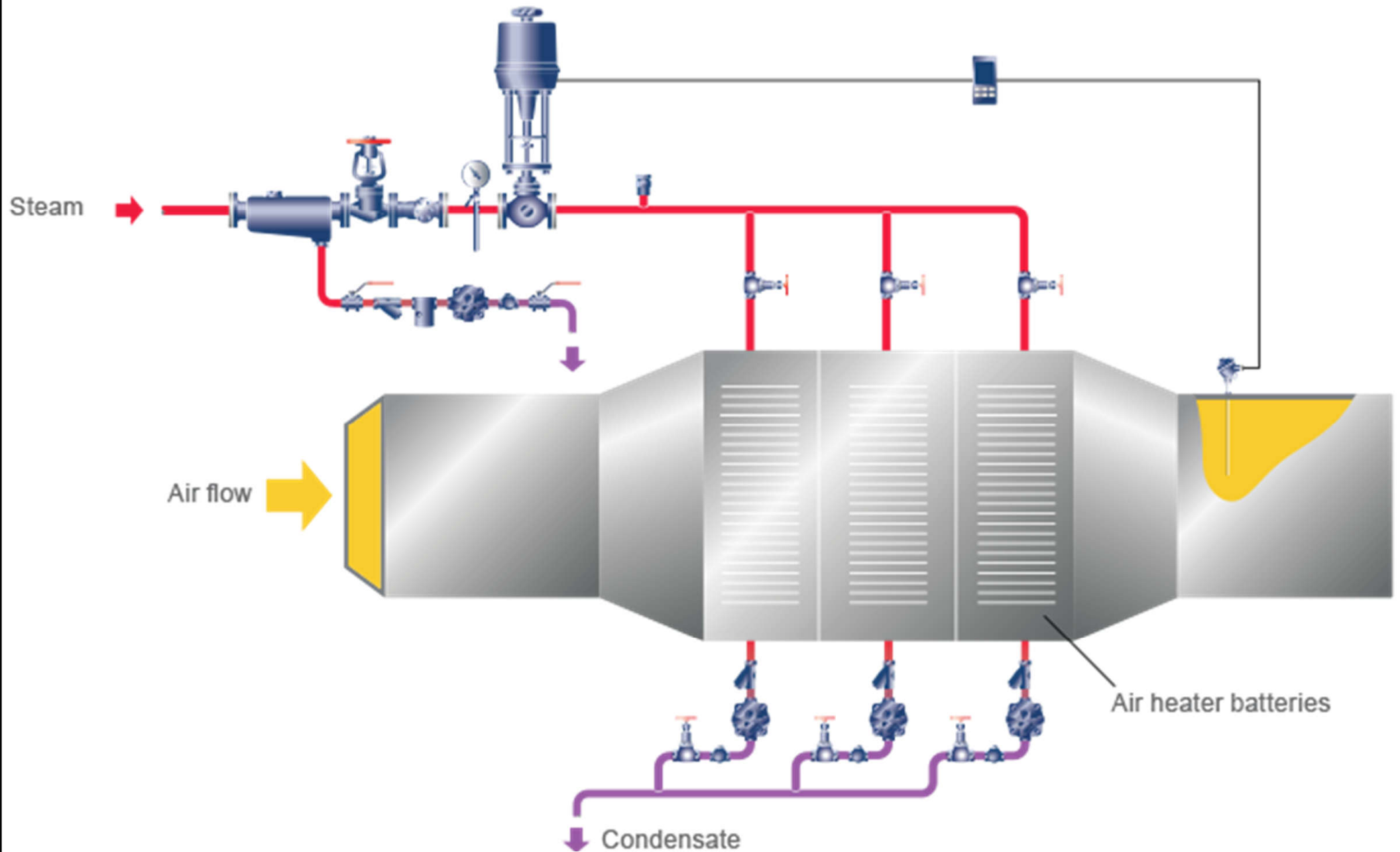

Heat transfer equations for steam heating

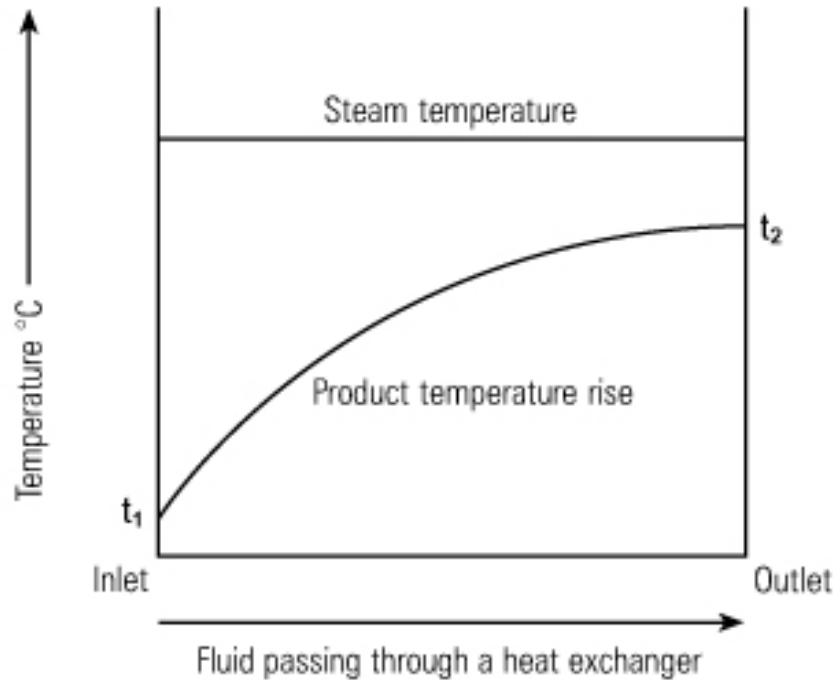

Log mean temperature difference (LMTD)

$$\Delta T_{LMTD} = \frac{T_2 - T_1}{\ln \left(\frac{T_s - T_1}{T_s - T_2} \right)}$$

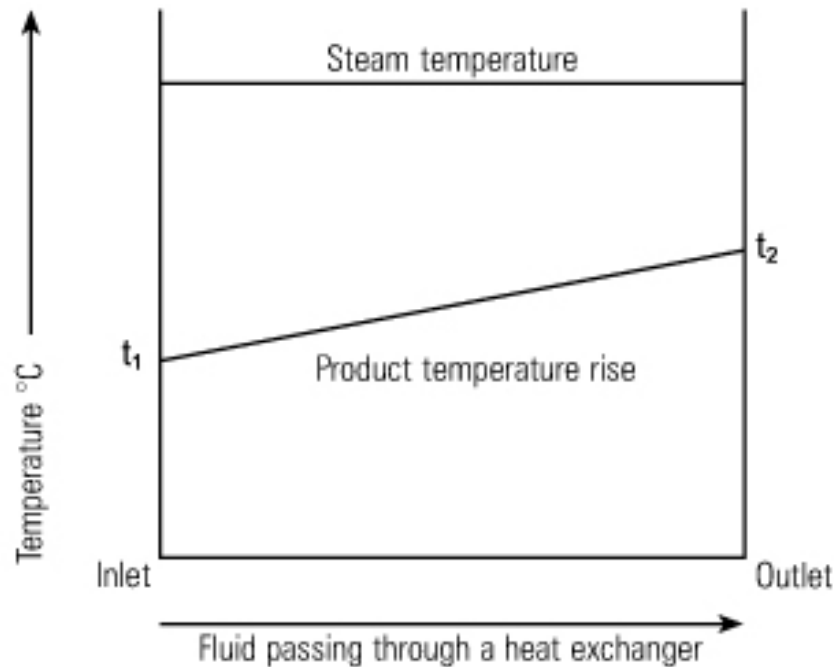

Arithmetic mean temperature difference (AMTD)

$$\Delta T_{AMTD} = T_s - \left(\frac{T_1 + T_2}{2} \right)$$

Steam	Hot water	High temperature oils
High heat content Latent heat approximately 2 100 kJ/kg	Moderate heat content Specific heat 4.19 kJ/kg °C	Poor heat content Specific heat often 1.69-2.93 kJ/kg °C
Inexpensive Some water treatment costs	Inexpensive Only occasional dosing	Expensive
Good heat transfer coefficients	Moderate coefficients	Relatively poor coefficients
High pressure required for high temperatures	High pressure needed for high temperatures	Low pressures only to get high temperatures
No circulating pumps required Small pipes	Circulating pumps required Large pipes	Circulating pumps required Even larger pipes
Easy to control with two way valves	More complex to control - three way valves or differential pressure valves may be required	More complex to control - three way valves or differential pressure valves may be required
Temperature breakdown is easy through a reducing valve	Temperature breakdown more difficult	Temperature breakdown more difficult
Steam traps required	No steam traps required	No steam traps required
Condensate to be handled	No condensate handling	No condensate handling
Flash steam available	No flash steam	No flash steam
Boiler blowdown necessary	No blowdown necessary	No blowdown necessary
Water treatment required to prevent corrosion	Less corrosion	Negligible corrosion
Reasonable pipework required	Searching medium, welded or flanged joints usual	Very searching medium, welded or flanged joints usual
No fire risk	No fire risk	Fire risk
System very flexible	System less flexible	System inflexible

Comparison of heating media with steam

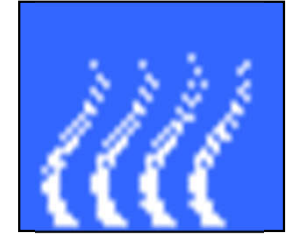

Uses of steam

- Typical applications for steam in industry: *
 - Heating/Sterilization
 - Propulsion/Drive
 - Motive
 - Atomization
 - Cleaning
 - Moisturization
 - Humidification

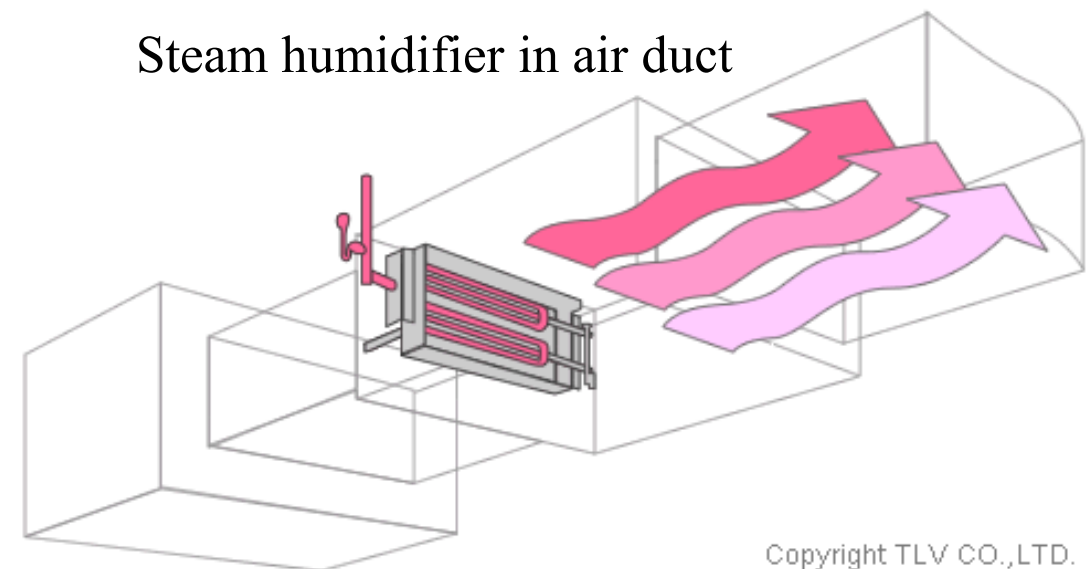

Uses of steam

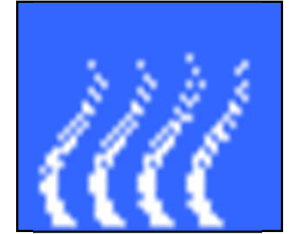

- Unique properties of steam for applications:
 - Sterility – sterilizing in hospitals & food industry
 - High heat content – means smaller pipes than a water-based system
 - High heat transfer value (w/ change of state) – means smaller heat exchangers
 - Ease of distribution – no pumps are required
 - Flexibility – can provide the means to heat, cool (absorption chillers) and humidify

Comparison between steam and water for humidification

Factor	Steam	Water
Cleanliness	Clean and sterile. Can be used in clean areas	Disinfection needed. Care must be taken to avoid formation of stagnant pools. Not suitable for clean areas
Efficiency	Easily absorbed	Carryover normal. Eliminator plates necessary
Heating	No change in air temperature	Reheat battery needed
Cooling	No cooling effect	Can provide evaporative cooling
Controllability	Easily controlled	Difficult to control

Uses of steam

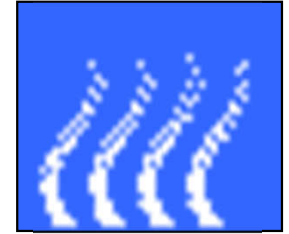

- Advantages of steam over hot water systems:
 - No pumps needed: steam flows through system unaided
 - Smaller heat emitters
 - Low density: steam can be used in tall buildings where water systems create excessive pressure
 - Terminal units can be added/removed easily
 - Steam components can be repaired or replaced just by closing the steam supply (no associated draining and refilling a water system)
 - Steam system temperature can be controlled by varying either steam pressure or temperature
- Disadvantages:
 - More complicated, more maintenance & supervision

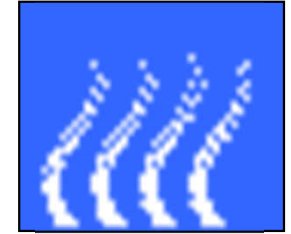

Uses of steam

- Utilizing latent heat (steam heating) for heat transfer is more effective than utilizing sensible heat (hot water or oil heating), as a much higher amount of energy is released in a shorter period of time

Property	Advantage
Rapid even heating through latent heat transfer	Improved product quality and productivity
Pressure can control temperature	Temperature can be quickly and precisely established
High heat transfer coefficient	Smaller required heat transfer surface area, enabling reduced initial equipment outlay

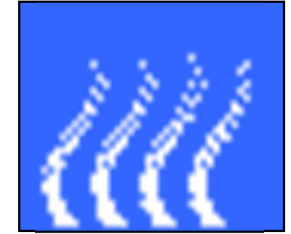

Uses of steam

- Use steam directly for heating
 - Low pressure (LP): up to 35 kPa
 - Medium pressure (MP): 140 to 550 kPa
 - High pressure (HP): 550 to 1400 kPa
- Low pressure steam
 - It has a higher heat content
 - Causes less risk of noise and wear
- Medium or high pressure steam
 - For large installations with long steam mains
 - Requires pressure-reducing set for appliances

Operating principle of steam heating

Why air valve? Where to put it?

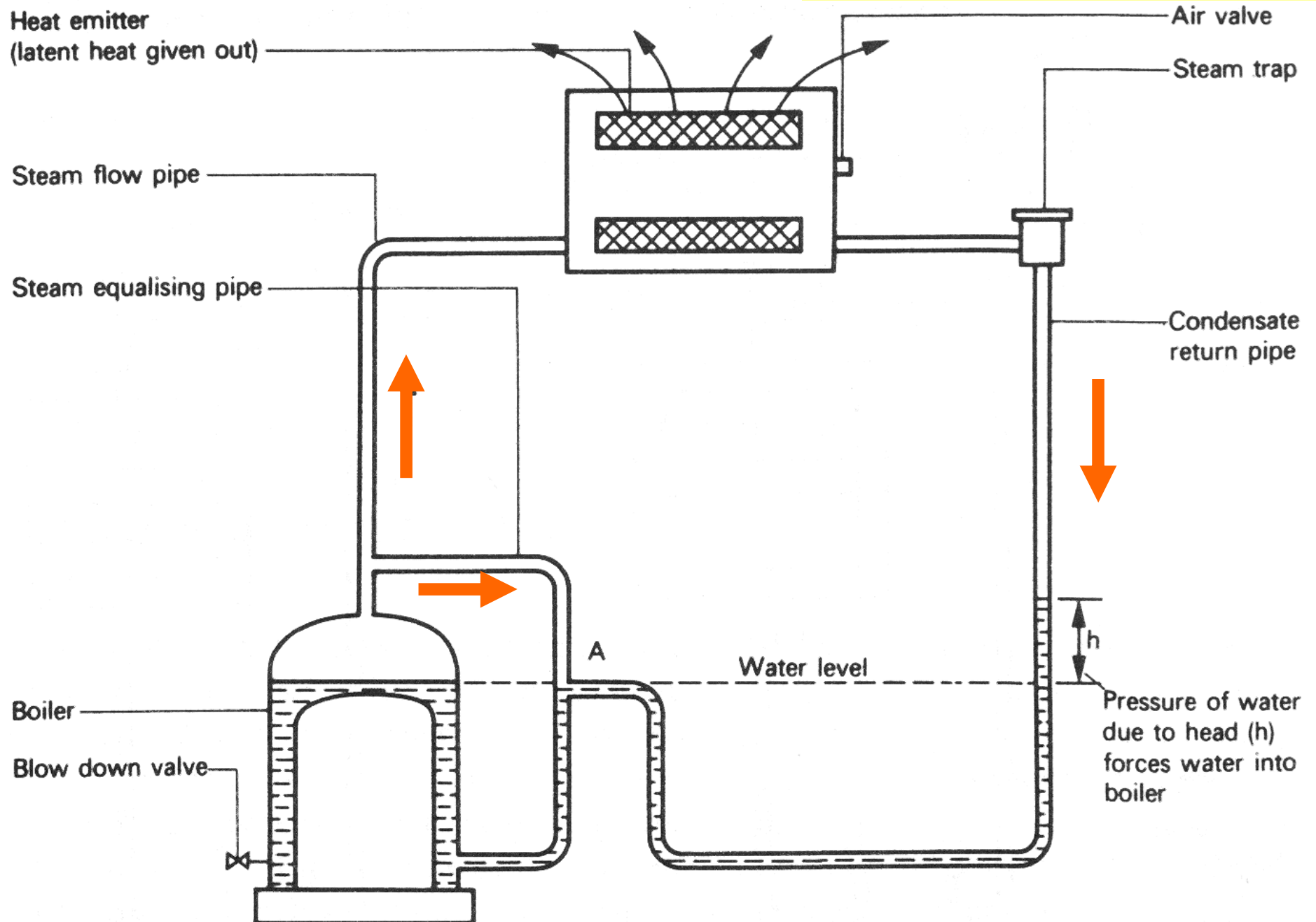

Steam system



- Basic arrangements: boiler plant using steam pressurisation
 - Hot water boiler (w/ steam maintained inside)
 - Boiler feed pump & cistern
 - Circulating pump & pipework
 - Cooling water bypass (mixing to control the pressure)
 - Blow down pipe & valve
- Steam & water are at saturation temperature

Boiler plant using steam pressurisation

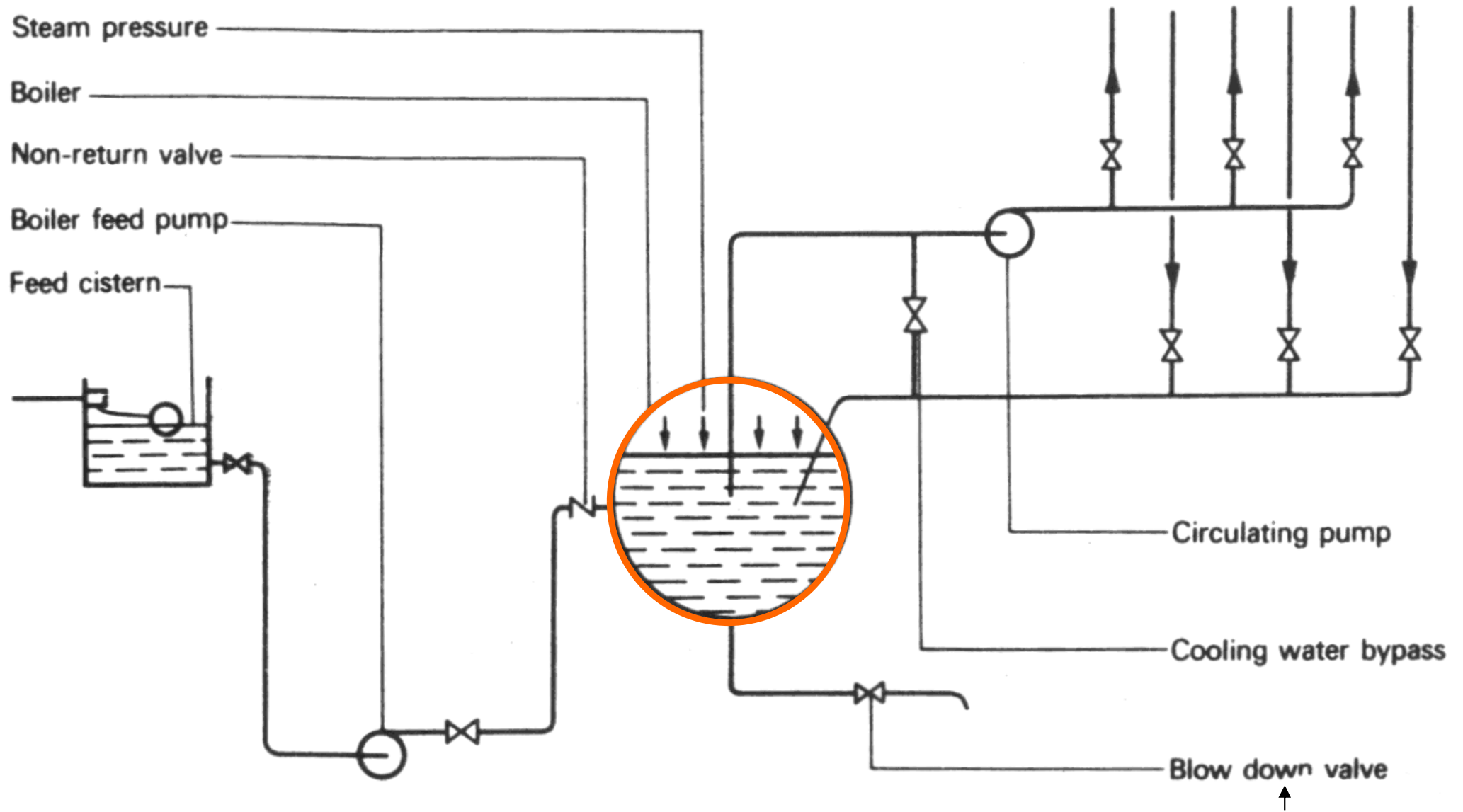

Why blow down?

Steam system



- Classification of steam systems:
- By method of condensate return
 - 1) By gravity (runs back to boiler)
 - 2) By automatic pump (pumped back to boiler)
 - 3) By condensate lifting trap
- By pipe layout
 - One pipe or two pipe
 - Up-feed or down-feed

One-pipe gravity steam heating system

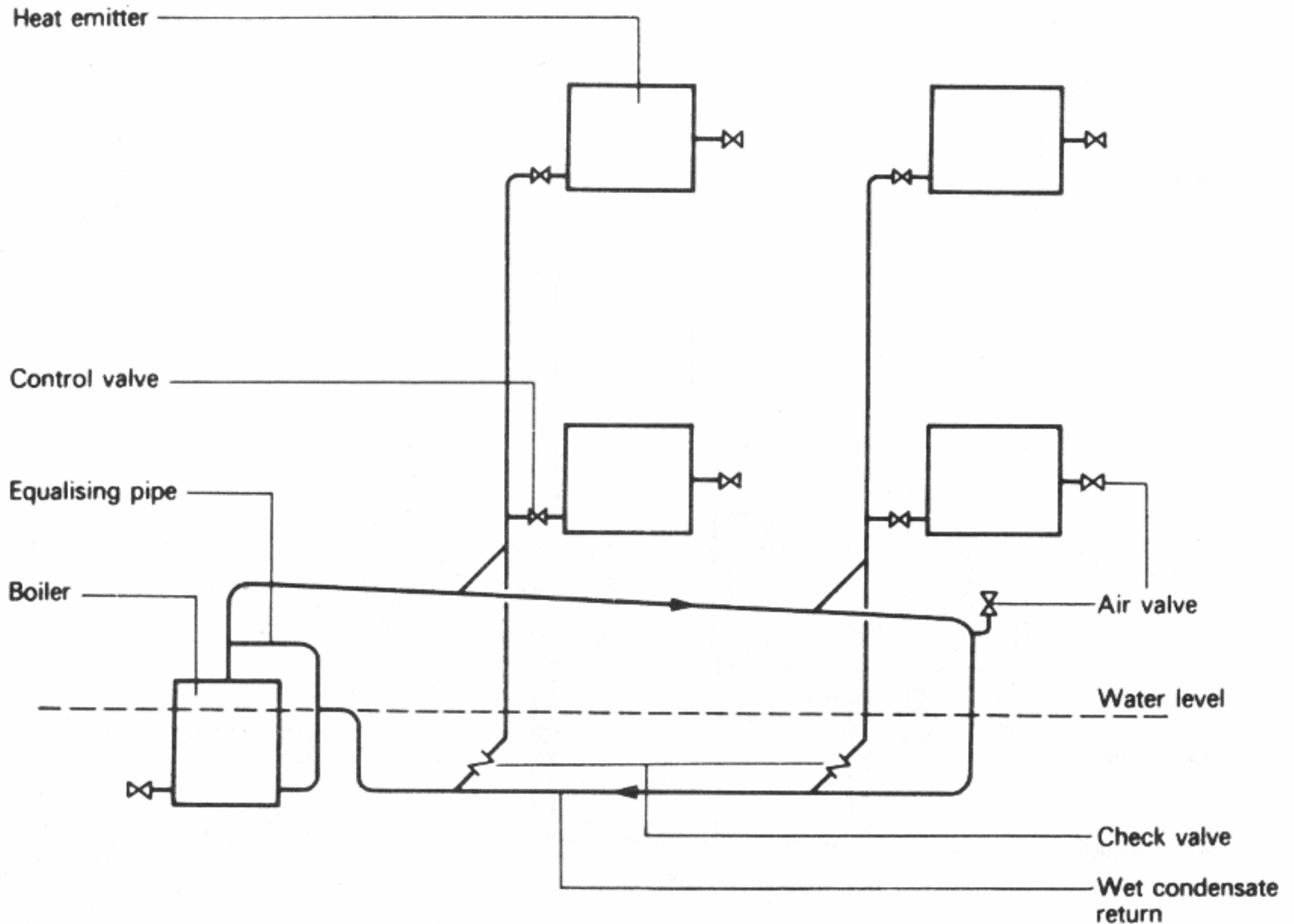

Two-pipe mechanical steam heating system

What are the functions of strainer, trap & sight glass?

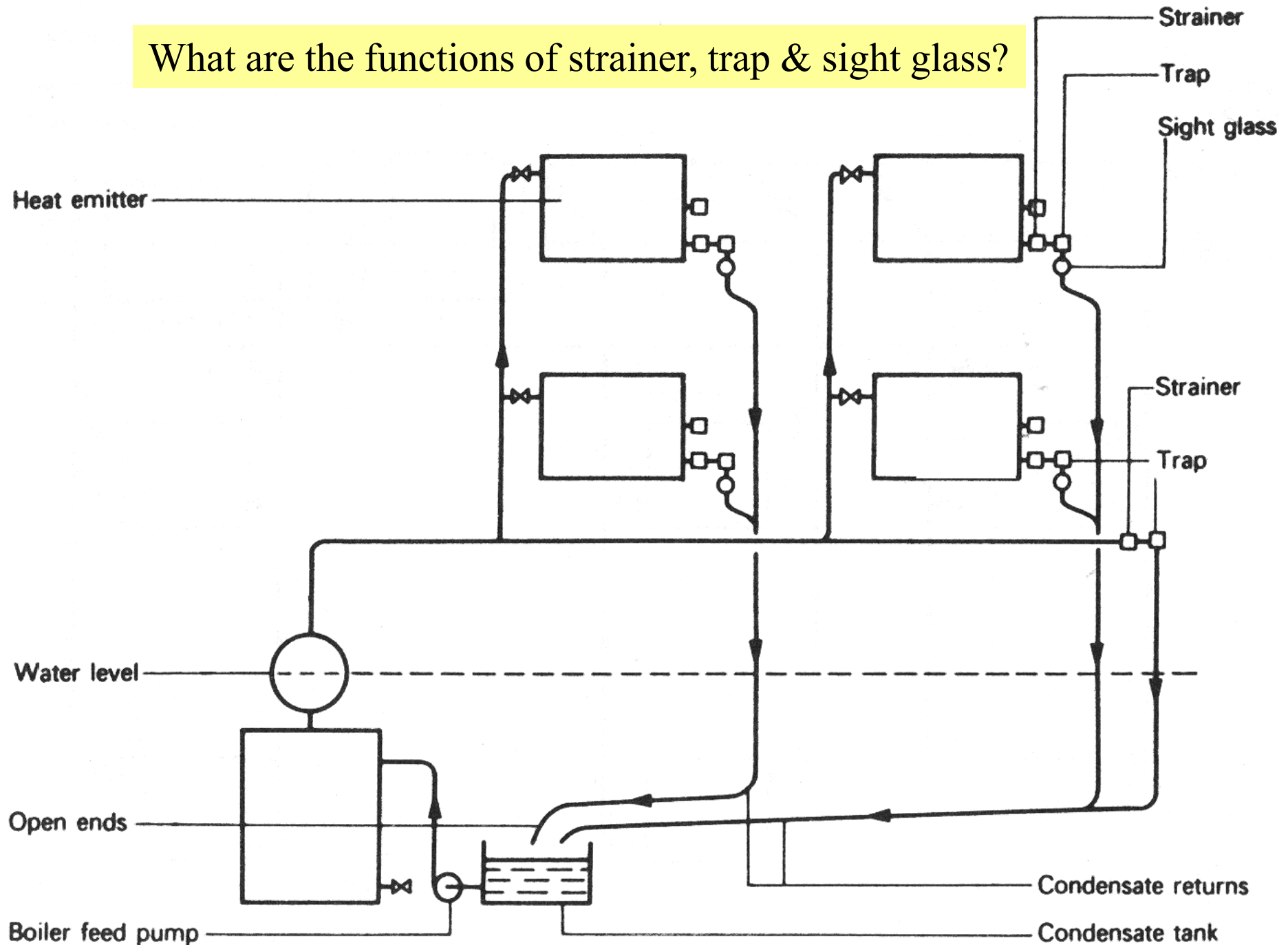

Steam system



- A steam system consists of:
 - Steam-supply/generating facility
 - Boilers, feedwater systems, heat exchangers (e.g. economizers), boiler and system controls, fuel and gas handling equipment (e.g., fuel trains, stacks), and steam/water treatment equipment and piping
 - Steam and condensate return/water piping system
 - The steam and condensate loop
 - Steam-use facility
 - For industrial and commercial needs, such as comfort heating, food processing, paper corrugation

Typical steam system

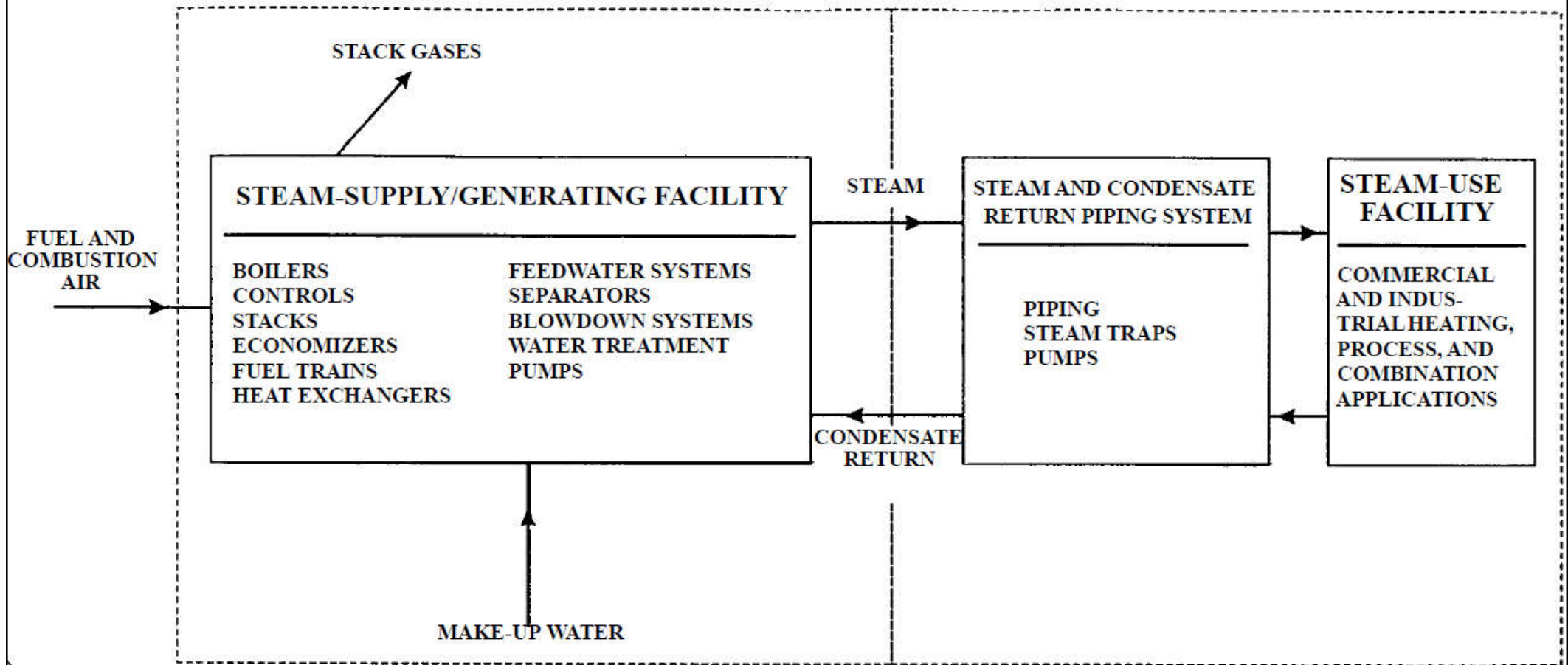

Four steps of the steam and condensate loop:

1. Generation, 2. Distribution, 3. Usage, and 4. Condensate return

Schematic diagram of a generic steam-generating facility

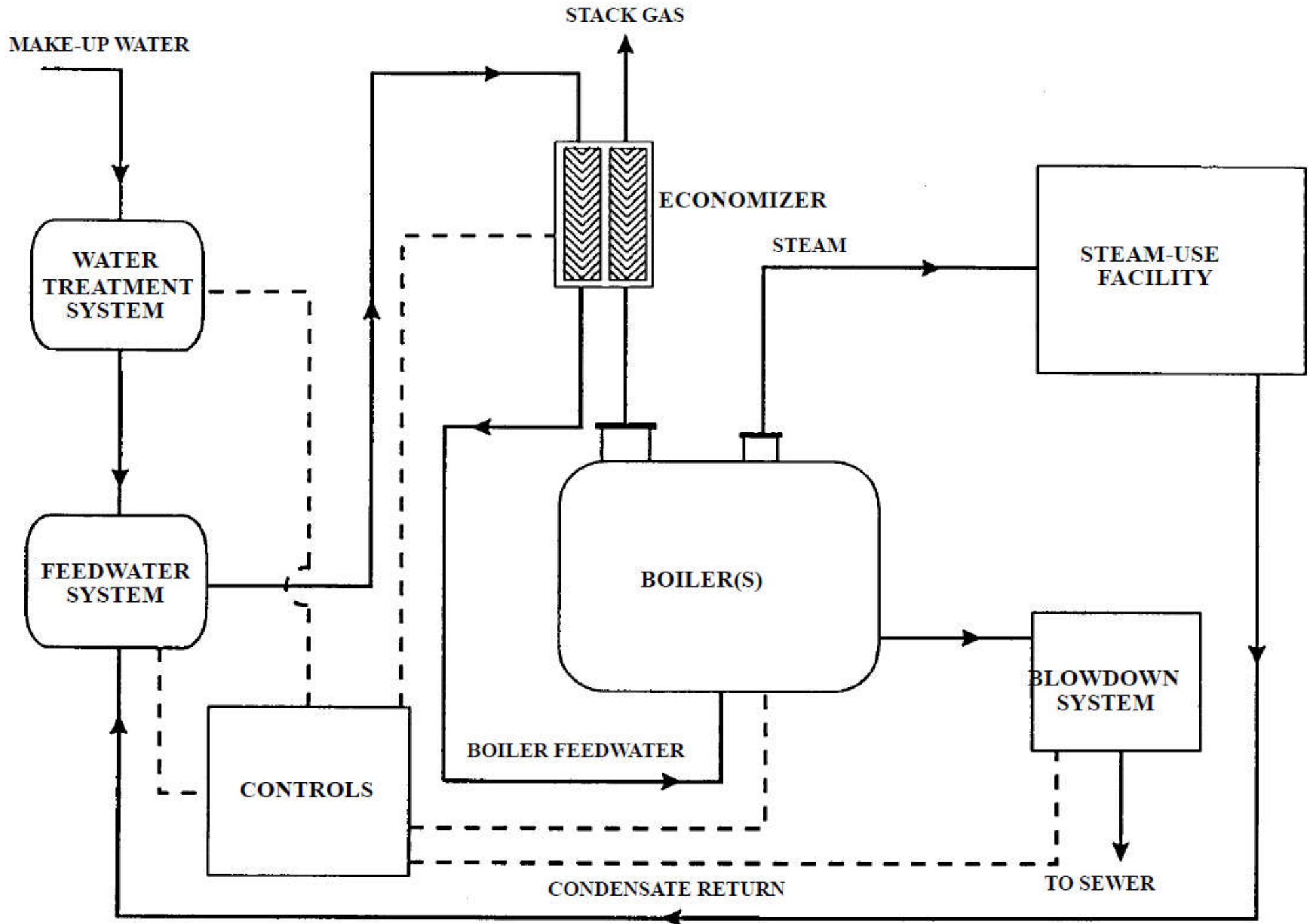

Four principal areas of a steam system

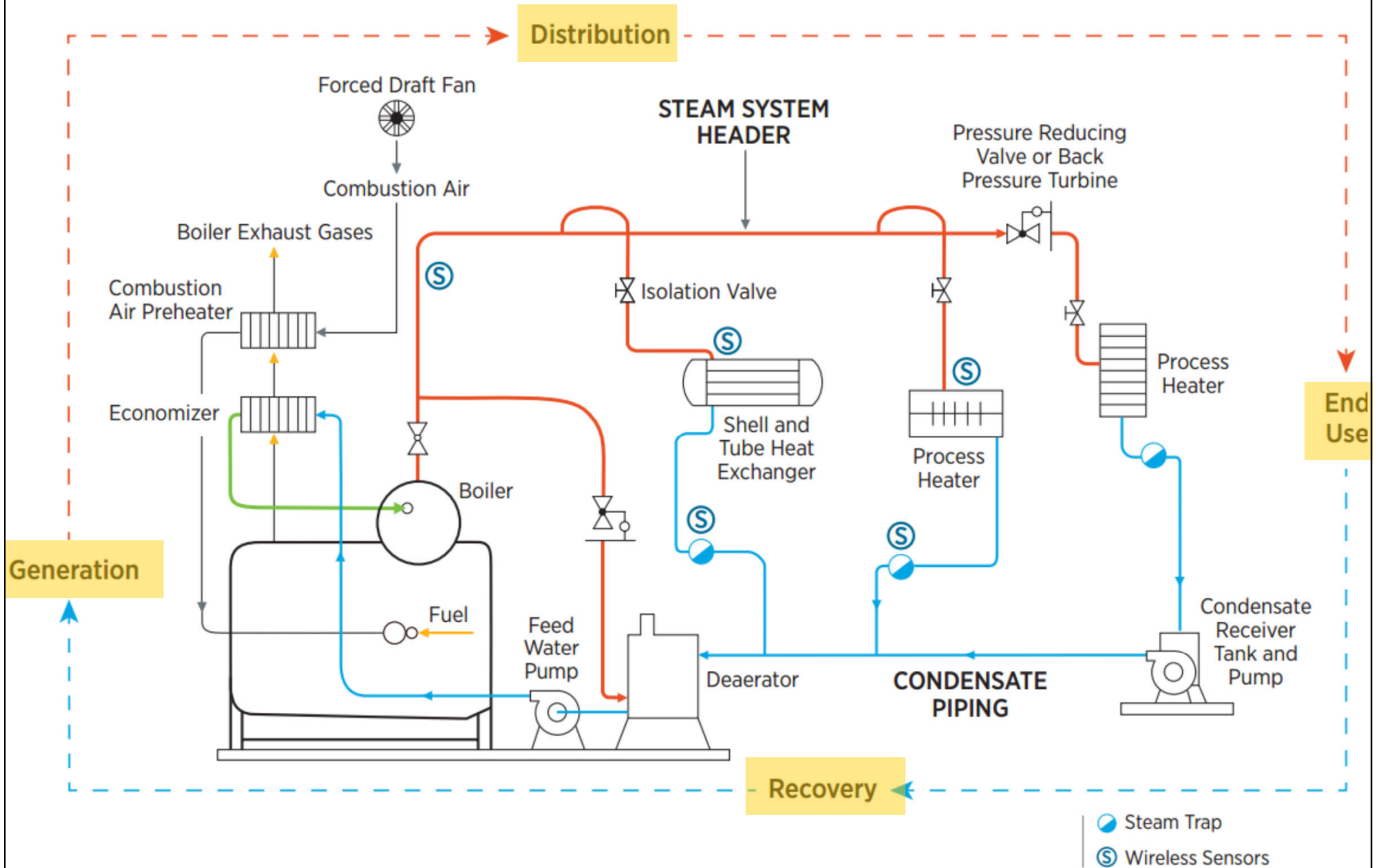

Steam system



- Steam quality: steam should be available at the point of use:
 - In the correct quantity
 - At the correct temperature and pressure
 - Free from air and incondensable gases
 - Clean
 - Dry

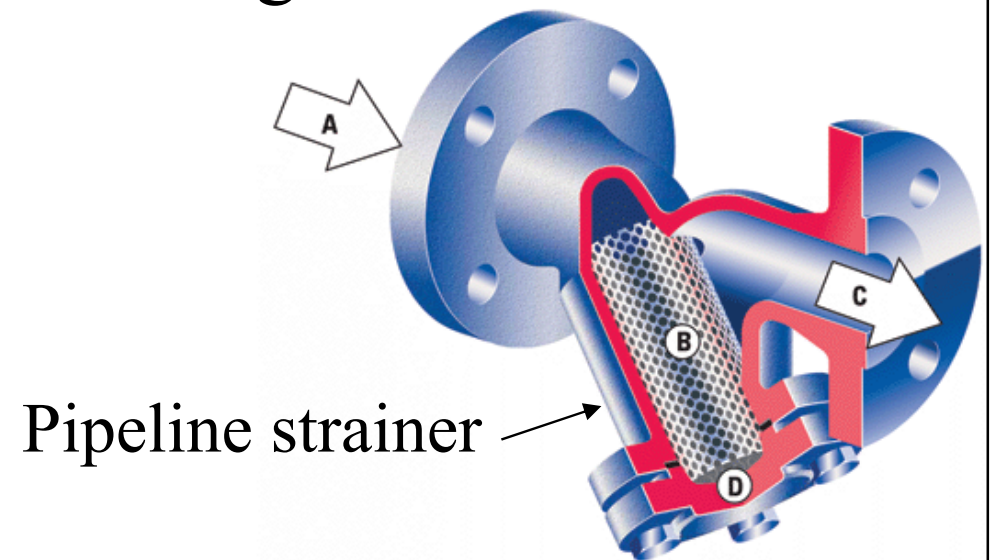

A typical basic steam circuit (the steam and condensate loop)

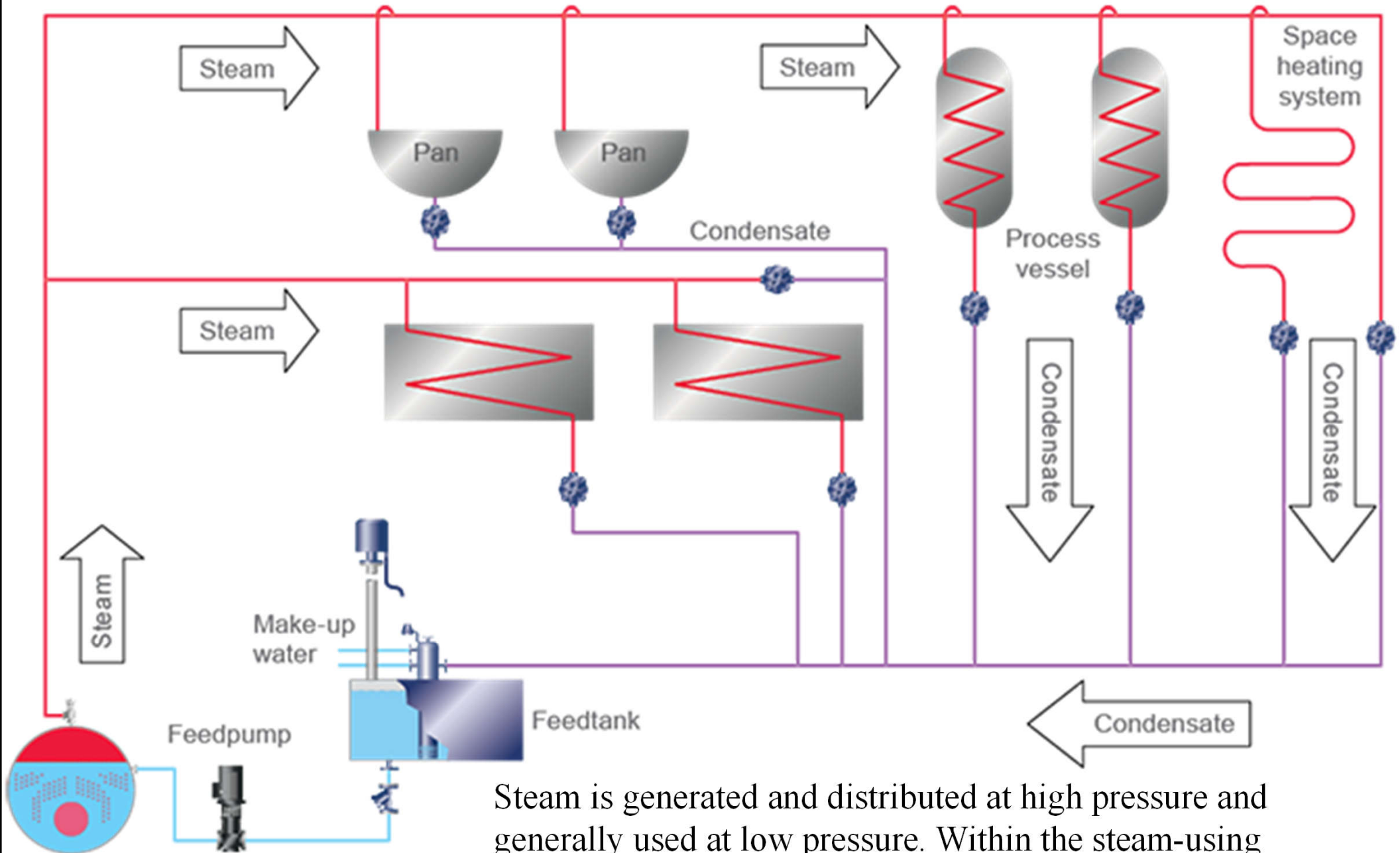

Steam is generated and distributed at high pressure and generally used at low pressure. Within the steam-using equipment, when the steam condenses it gives up its enthalpy of evaporation, transferring heat to the secondary medium.

Steam traps



- Steam traps

- Purpose: automatic valve to “trap” the steam and filter out condensate (i.e. condensed steam) and non-condensable gases (e.g. air)
- Definition by ANSI (American National Standard Institute):
 - *“Self contained valve which automatically drains the condensate from a steam containing enclosure while remaining tight to live steam, or if necessary, allowing steam to flow at a controlled or adjusted rate. Most steam traps will also pass non-condensable gases while remaining tight to live steam.”*



Steam traps

- Why are steam traps installed?
 - When steam has given up its latent heat, steam condenses and becomes condensate
 - Heating efficiency will suffer if condensate is not removed as rapidly as possible
- Three main groups of steam traps:
 - (a) Thermostatic
 - (b) Mechanical
 - (c) Thermodynamic

Typical types of steam traps



Ball float type



Thermodynamic type



Thermostatic type



Inverted bucket type

“The duty of a steam trap is to discharge condensate while not permitting the escape of live steam”

New functions in modern steam traps:
e.g. automatic air venting and scale removal

(See also: The History of Steam Traps

<https://www2.tlv.com/en-au/steam-info/steam-theory/steamtrap-basics/history-of-steam-traps-pt1>
<https://www2.tlv.com/en-au/steam-info/steam-theory/steamtrap-basics/history-of-steam-traps-pt2>)

Thermostatic

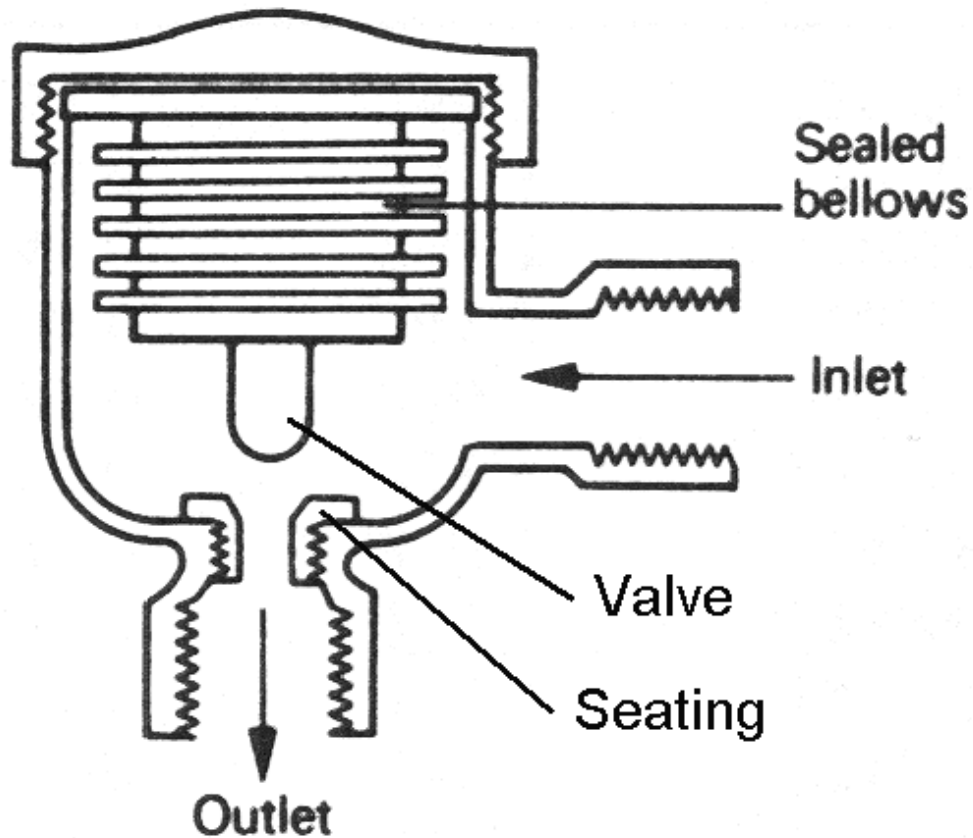

Thermostatic steam trap

Operating principle:

- The closed bellows contains a volatile spirit which has a boiling point suiting the temperature
- When steam enters the traps, the volatile spirit expands → open the bellows, close the valve
- Water (condensate) enters the traps at a temperature lower than steam, the spirit contracts and closes the bellows → open the valve + allow water to flow back to boiler

Mechanical

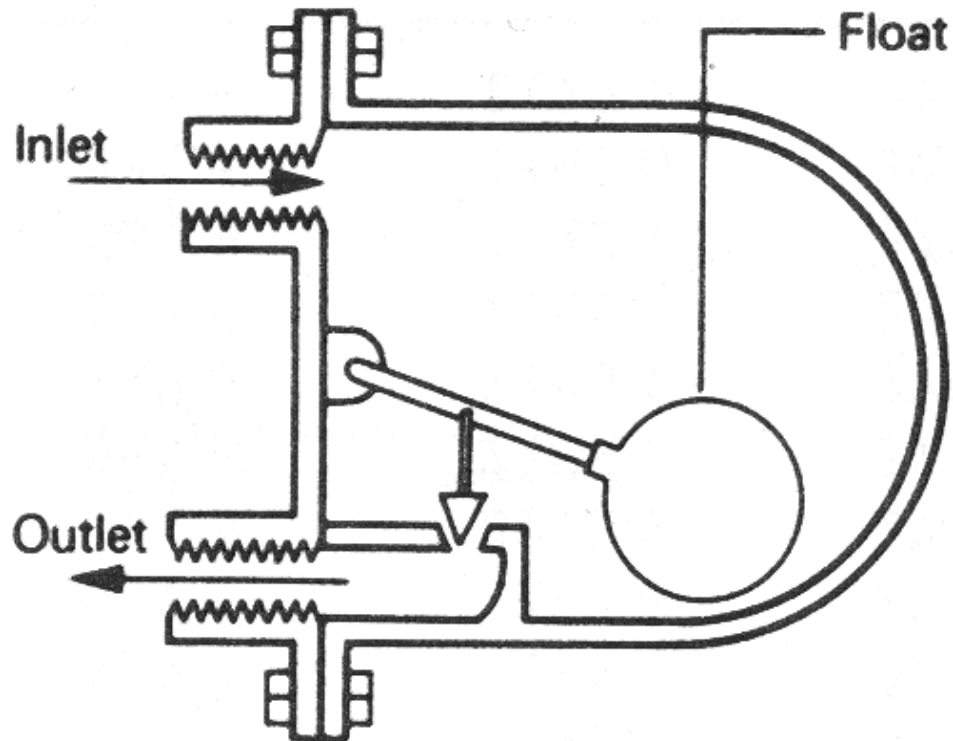

Ball float steam trap

Operating principle:

- Steam enters the trap → ball float valve suspended → weight of float keeps outlet valve close
- Water (condensate) enters trap → float buoyant → opens valve → allow water flowing back to boiler

(See also: <https://www2.tlv.com/en-au/steam-info/steam-theory/steamtrap-basics/mechanical-steam-traps>)

Mechanical

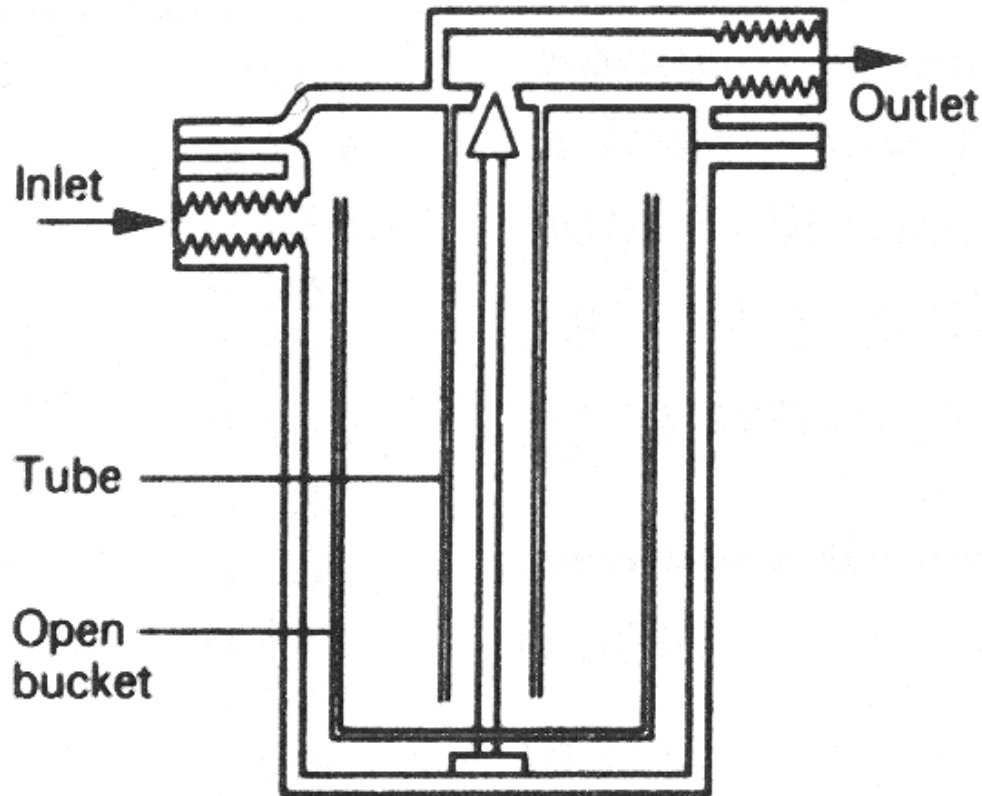

Open bucket steam trap

Operating principle:

- Bucket floats → outlet valve close
- Water (condensate) enters trap → overflows into bucket → bucket to sink → open the valve
- Steam forces water out of bucket through the tube → bucket is buoyant → closing the valve

(See also: <https://www2.tlv.com/en-au/steam-info/steam-theory/steamtrap-basics/mechanical-steam-traps>)

Mechanical

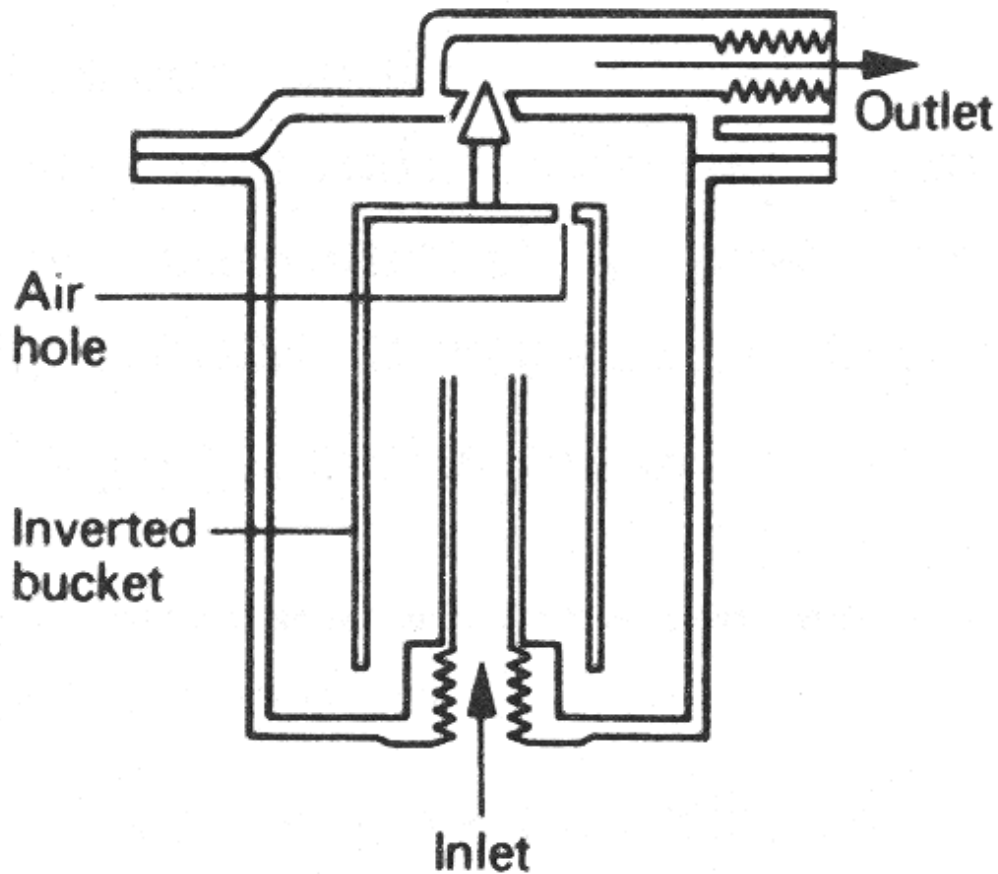

Inverted bucket steam trap

Operating principle:

- Steam enters the trap → bucket is lifted → valve is closed
- Water (condensate) enters trap → bucket fails under its own weight → valve opens → steam pressure forced water out

(See also: <https://www2.tlv.com/en-au/steam-info/steam-theory/steamtrap-basics/mechanical-steam-traps>)

Thermodynamic

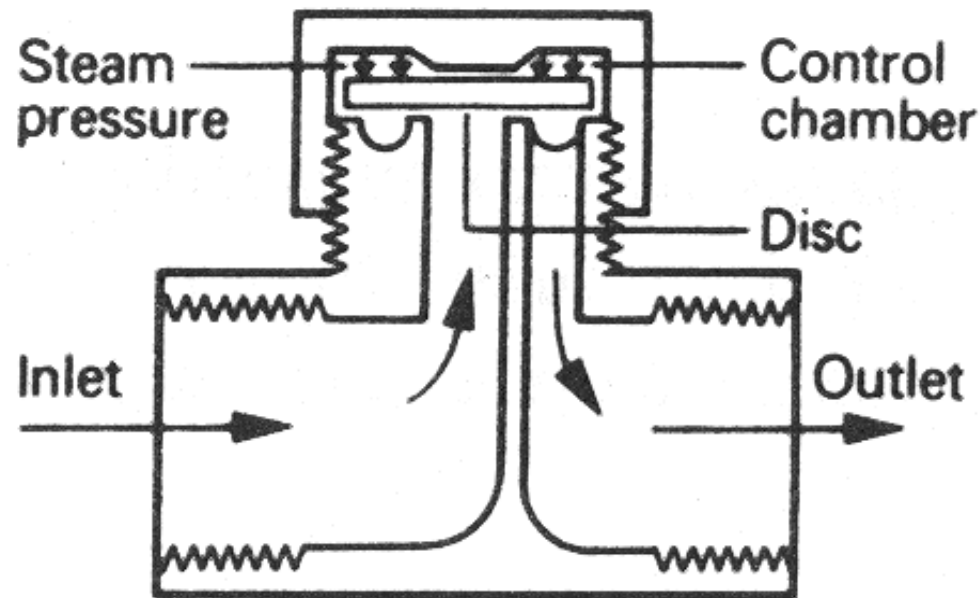

Thermodynamic steam trap

Bernoulli principle:

kinetic pressure + potential energy
= constant

Operating principle:

- Steam flows through trap → increase kinetic energy between disc & seating → reduce pressure energy at this point → disc moves nearer the seating until kinetic energy decreases
- Reduction in kinetic energy → increase pressure energy → lift the disc from seating (prevented from doing so by the steam pressure acting upon the top of the disc in the control chamber)
- Area at the top of the disc > area at inlet underneath → the upper pressure forces the disc firmly on to its seat

Thermodynamic

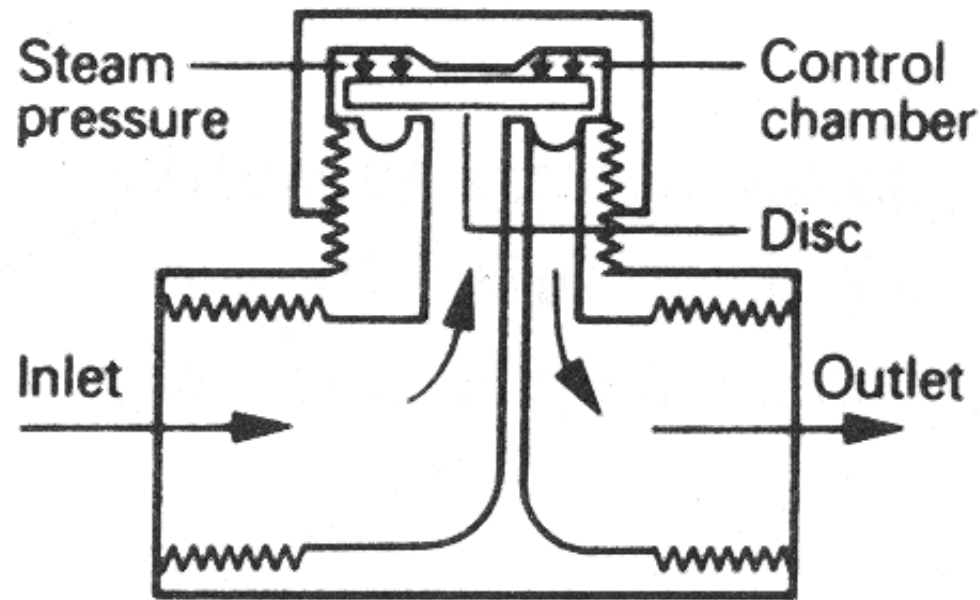

Thermodynamic steam trap

Bernoulli principle:

kinetic pressure + potential energy
= constant

Operating principle (cont'd):

- Water (condensate) enters trap → steam above disc condenses → reduce pressure → disc forced up → water flow through trap
- Water (condensate) flows through trap at a lower velocity than steam → insufficient reduction in pressure below the disc → traps remains open until steam enters

(See also: <https://www2.tlv.com/en-au/steam-info/steam-theory/steamtrap-basics/how-disc-traps-work>)



Steam traps

- Steam trap selection -- key considerations:
 - Pressure and temperature ratings, discharge capacity, trap type, body material, etc.
 - Selection process:
 - 1. Determine discharge requirements of the steam trap application (e.g. hot or subcooled discharge), and select the matching trap type
 - 2. Select trap model according to operating pressure, temperature, orientation, and any other relevant conditions
 - 3. Calculate application load requirements and apply the trap manufacturer's recommended safety factor
 - 4. Base the final trap selection on lowest Life Cycle Cost (LCC)

Steam trap selection: Understanding specifications

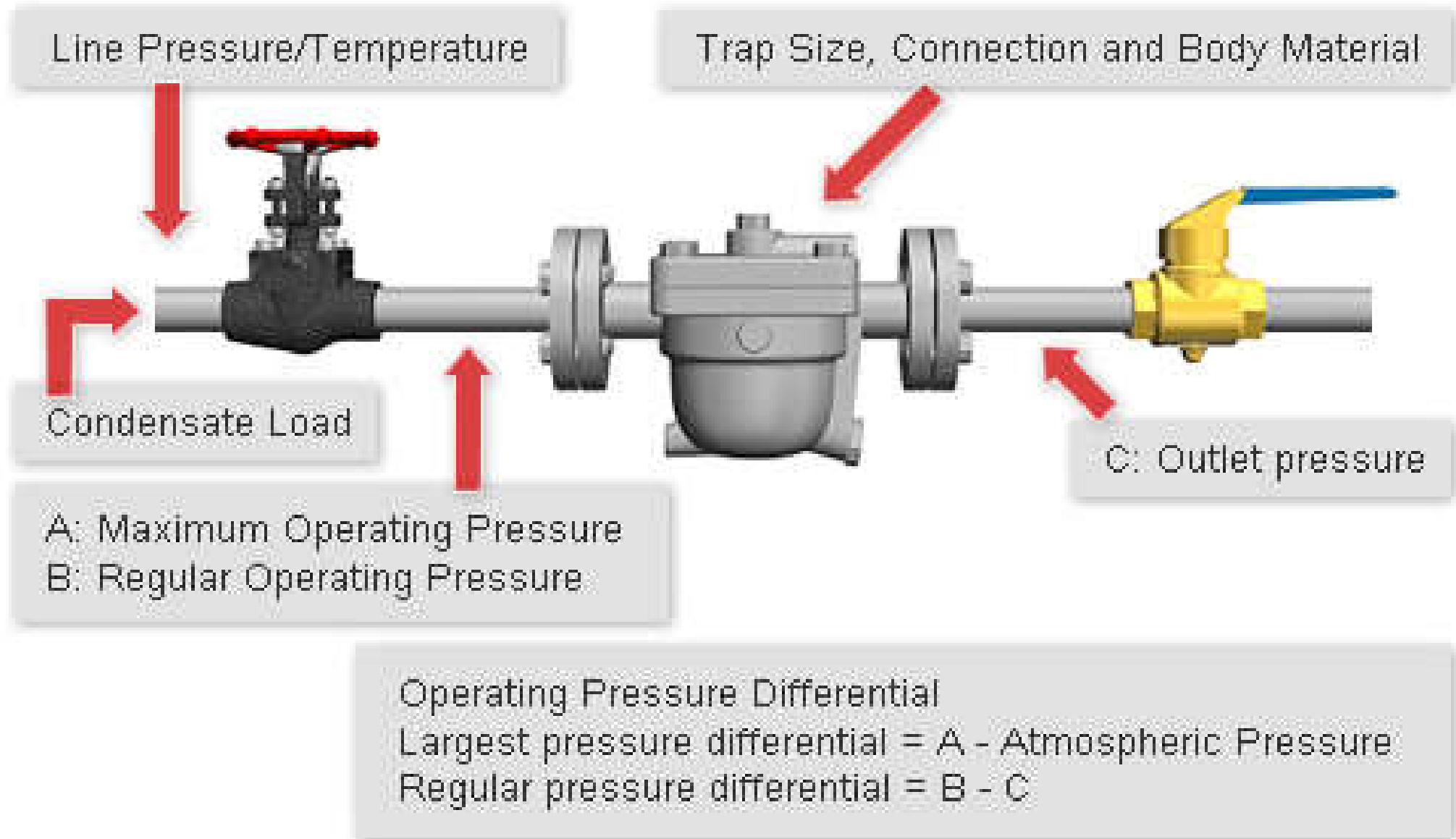

Recommended steam trap piping

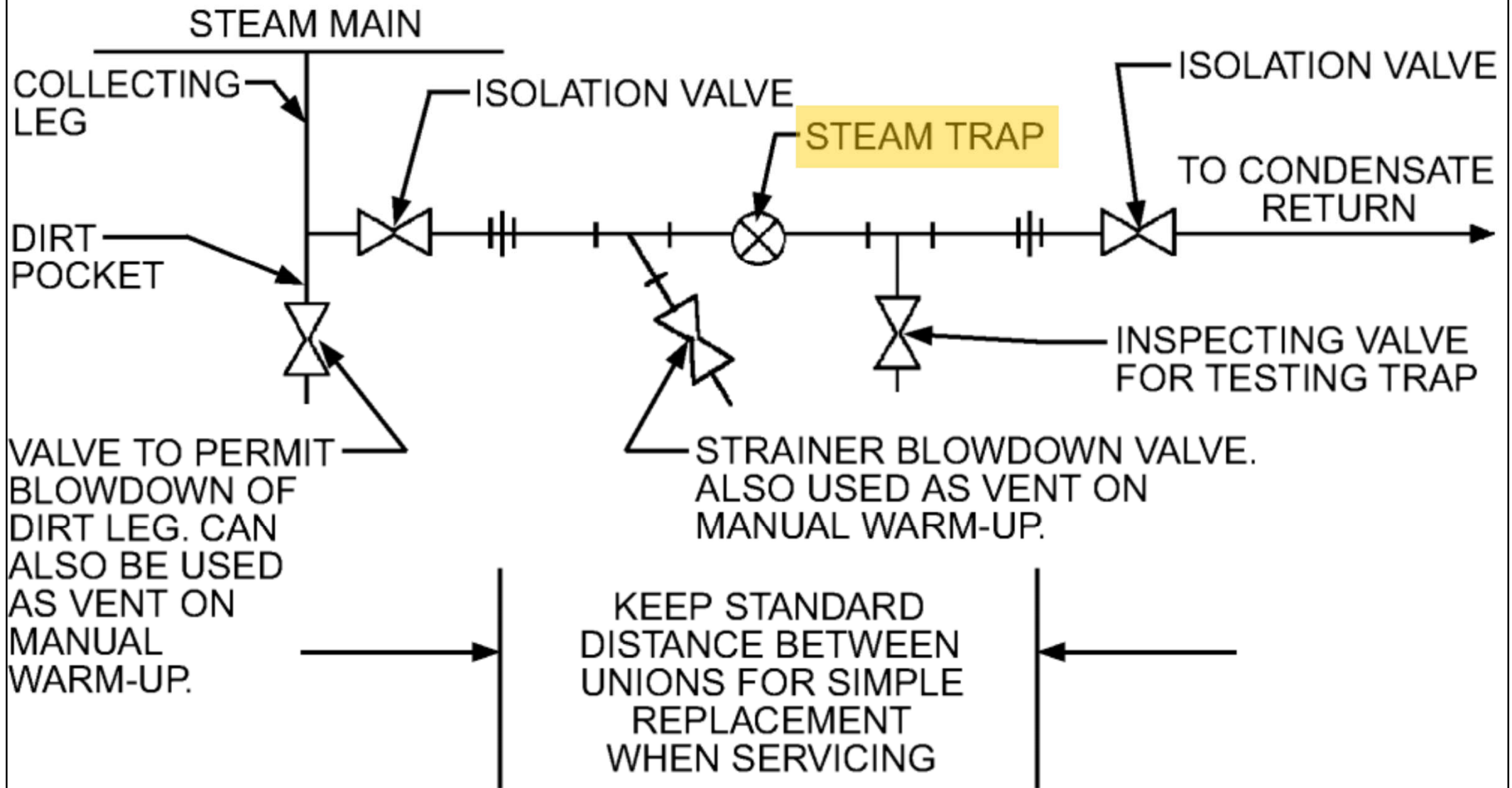

KEEP STANDARD
DISTANCE BETWEEN
UNIONS FOR SIMPLE
REPLACEMENT
WHEN SERVICING

Steam traps



- Steam traps and steam trapping (Learn about steam)
 - <https://www.spiraxsarco.com/Learn-about-steam>
 - Considerations for Selecting Steam Traps
 - Selecting Steam Traps:- (examples & applications)
 - Canteen Equipment; Oil Transfer/Storage; Hospital Equipment
 - Industrial Dryers
 - Laundries and Presses
 - Process Equipment
 - Space Heating Equipment
 - Steam Mains; Tanks and Vats; Pressure Reducing Valves
 - Testing and Maintenance of Steam Traps
 - Energy Losses in Steam Traps



Steam traps

- Steam trap and piping problems (typical):
 - Trap leaking live steam
 - Temperature control trap (to avoid overheating)
 - Trap installation orientation
 - Trap back pressure
 - Double trapping, group trapping
 - Steam locking, air binding
 - Water/Steam hammer (pressure shock/impact)

Water hammer -- Formation of a solid slug of water

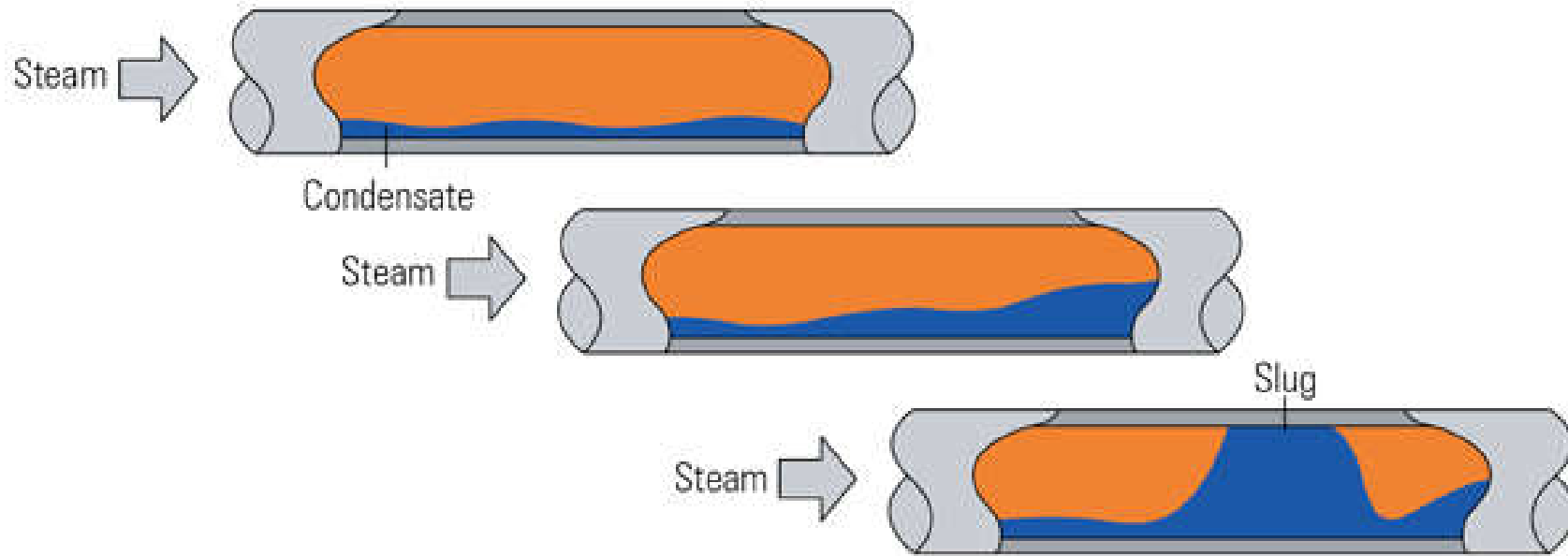

Potential sources of water hammer

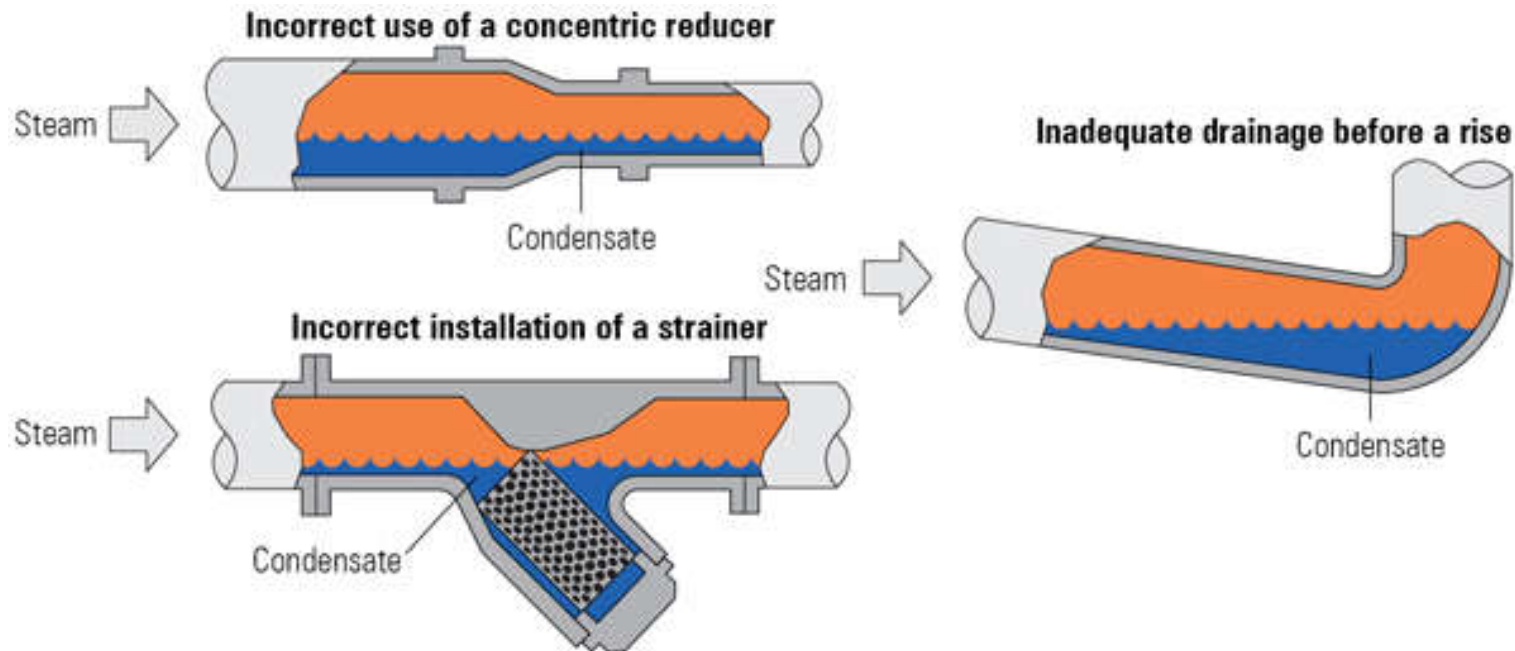

Steam traps



- Steam trap management
 - Steam trap losses - what it costs you
 - e.g. calculate the cost of losses from one trap, calculate steam leakage amounts from holes in piping
<https://www2.tlv.com/en-au/steam-info/steam-theory/energy-saving/cost-of-steam-trap-losses>
 - Steam trap testing
 - Through visual observation
 - Using temperature
 - Using sound

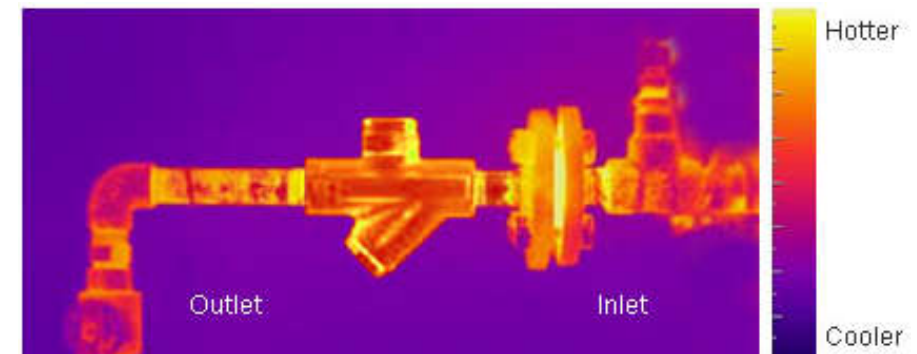

Steam boilers



- **Boilers** – classified according to:
 - Type of working fluid or heat carrier used
 - Such as steam and hot water
 - Physical arrangement of the working fluid
 - Fire tube: flue gas products flow through boiler tubes
 - Water tube: water circulates within boiler tubes
 - Combustion gases/fuels
 - Natural gas, town gas, diesel, etc.
 - Gas & oil replace coal for fuel of boiler/furnace
 - Easier to handle & less pollution product

A steam boiler system and components

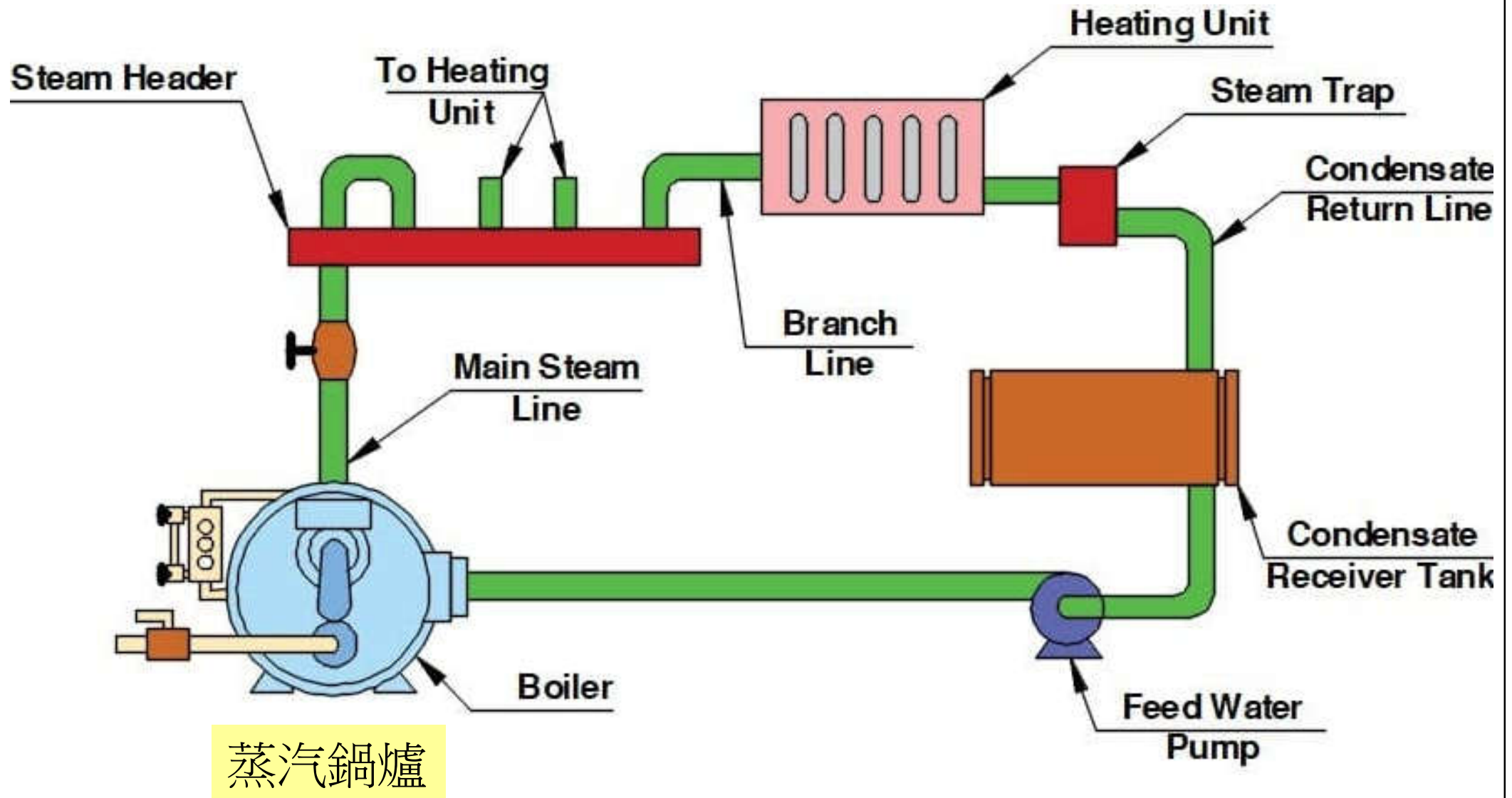

Basic diagram of a boiler

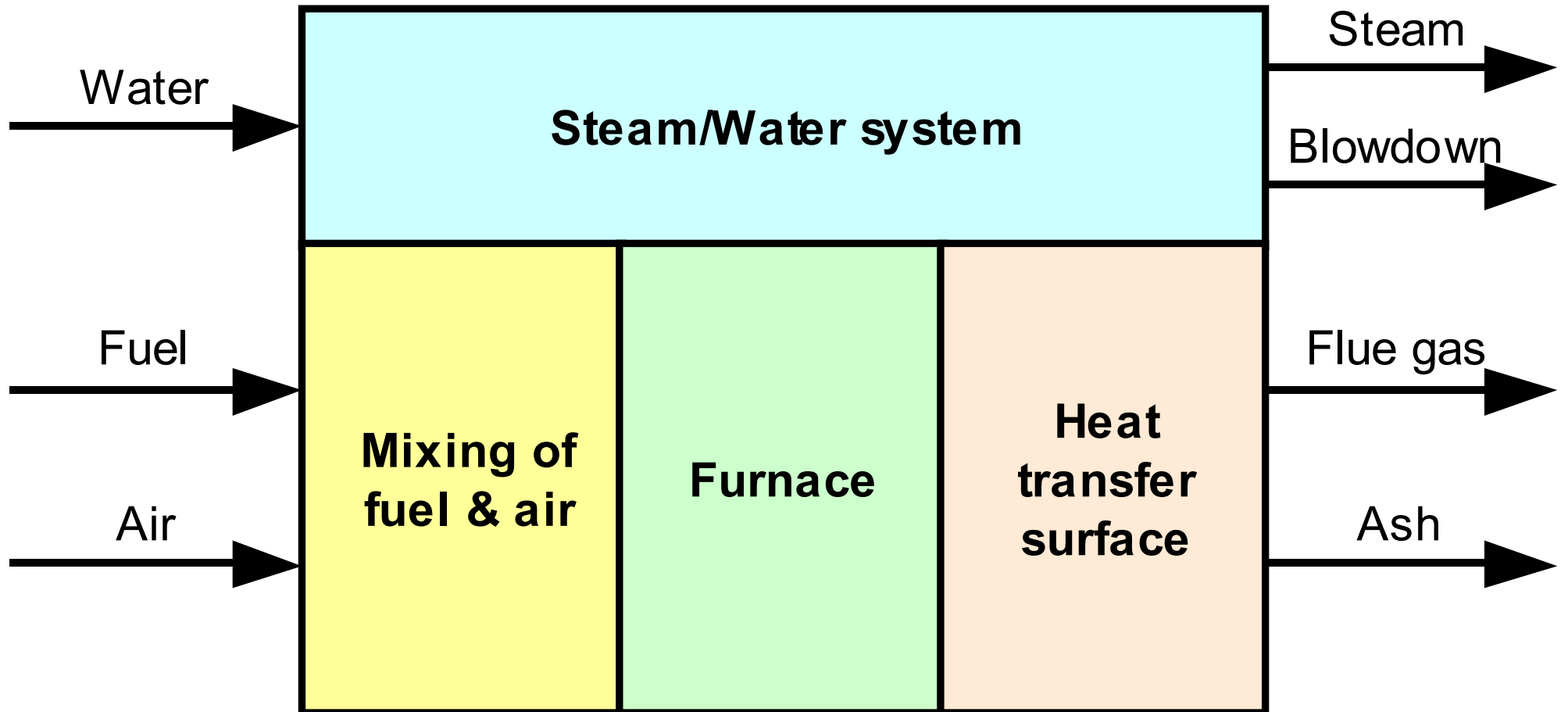

Steam boilers



- **Steam boilers** (high and low pressure)

- High-pressure >100 kPa

- Reduce size of boiler & steam piping (due to density)
- But decrease boiler efficiency
- Good for heat load at long distance

- Low-pressure ≤ 100 kPa

- Simpler in both design & operation
- No pressure-reducing valves are required
- Water chemical treatment less costly & complex

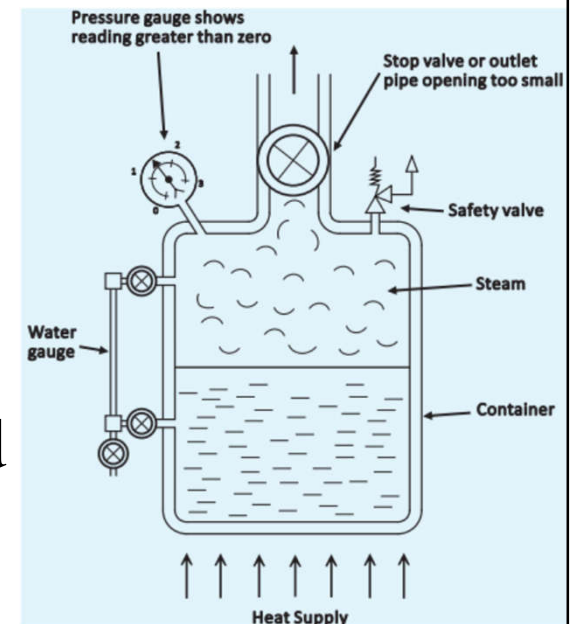

Steam boilers



- **Hot water boilers** (high and low temperature)
 - High-temperature hot water (HTHW) boiler
 - Water at temp. > 121 °C or pressure $> 1,100$ kPa
 - Carry greater heat; reduce pumping & piping costs
 - Low-temperature hot water (LTHW) boiler
 - Water at temp. < 96 °C or pressure $\leq 1,100$ kPa
- **Calorifiers**
 - Provide storage & allow heat exchange
 - Non-storage calorifiers can also be used for providing hot water for space heating

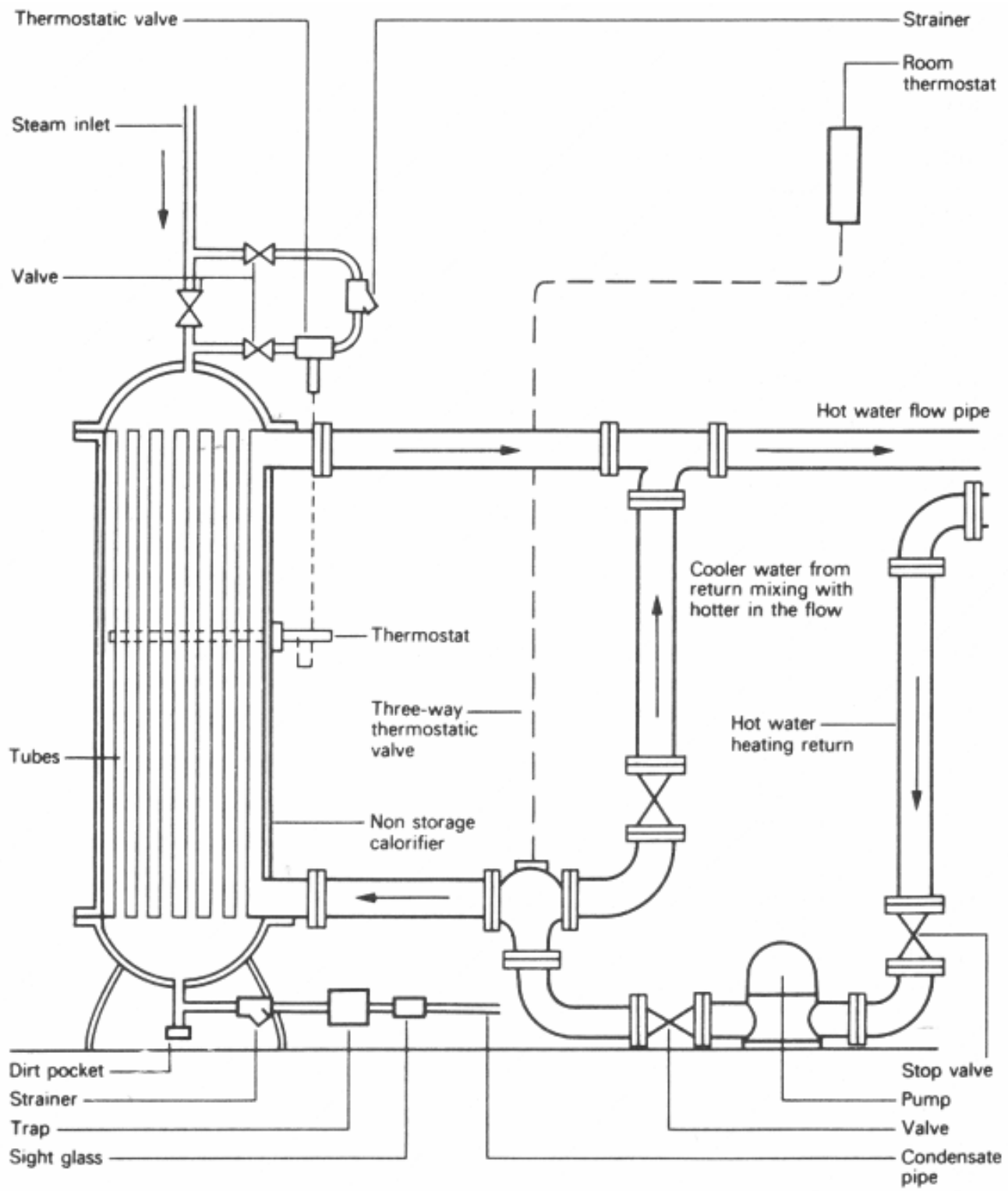

Non-storage
type calorifier

(Source: Hall, F. and Greeno, R., 2008. *Building Services Handbook*)

A hot water storage calorifier installation

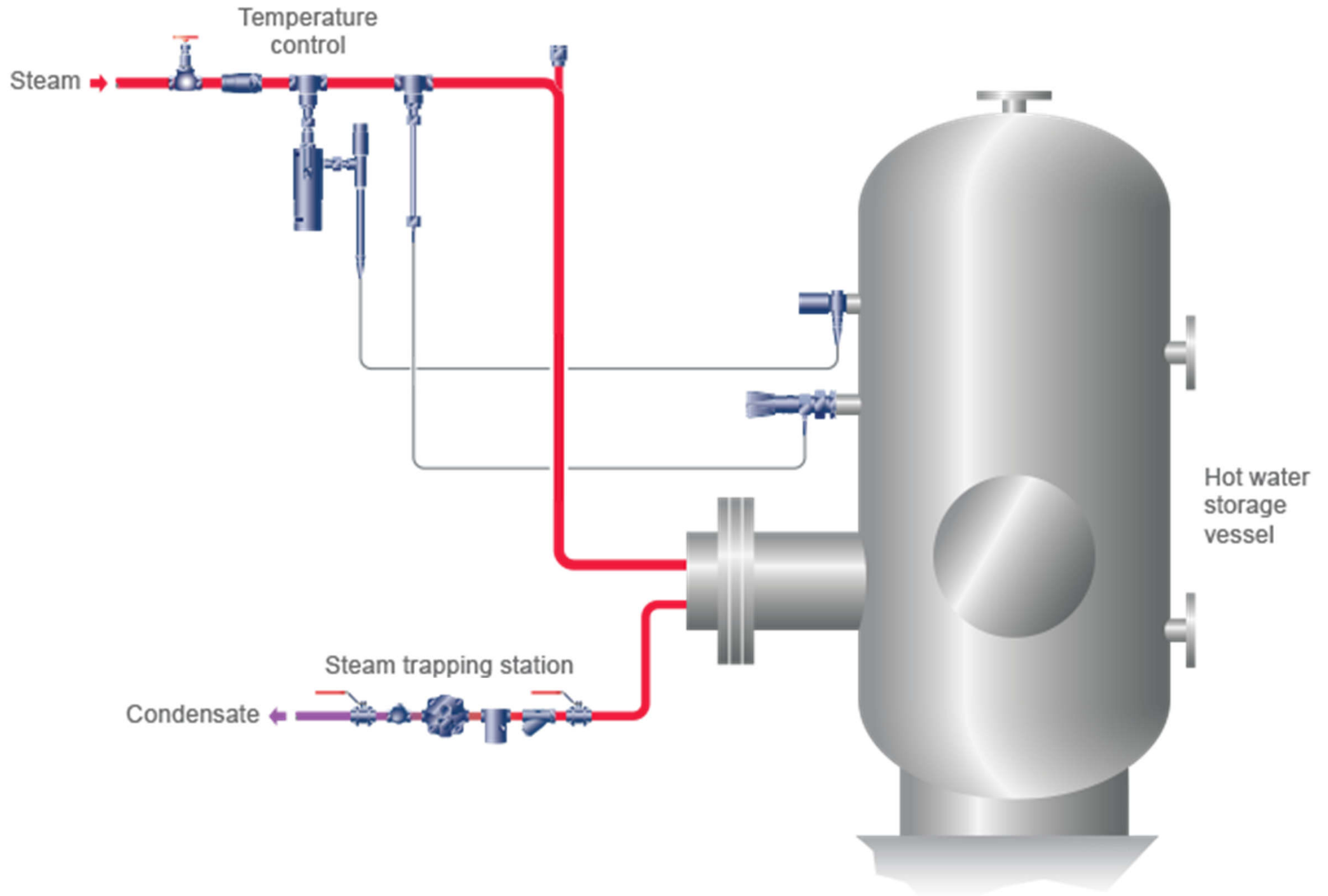

Steam boilers



- **Shell boilers**

- The heat transfer surfaces are all contained within a steel shell
- Also known as ‘fire tube’ or ‘smoke tube’ boilers
 - Products of combustion pass through the boiler tubes, which in turn transfer heat to the boiler water
- Typical types of shell boilers:
 - Lancashire boiler
 - Economic boiler (two-pass or three-pass)
 - Packaged boiler

Shell boiler – (a) dry back and (b) wet back configurations

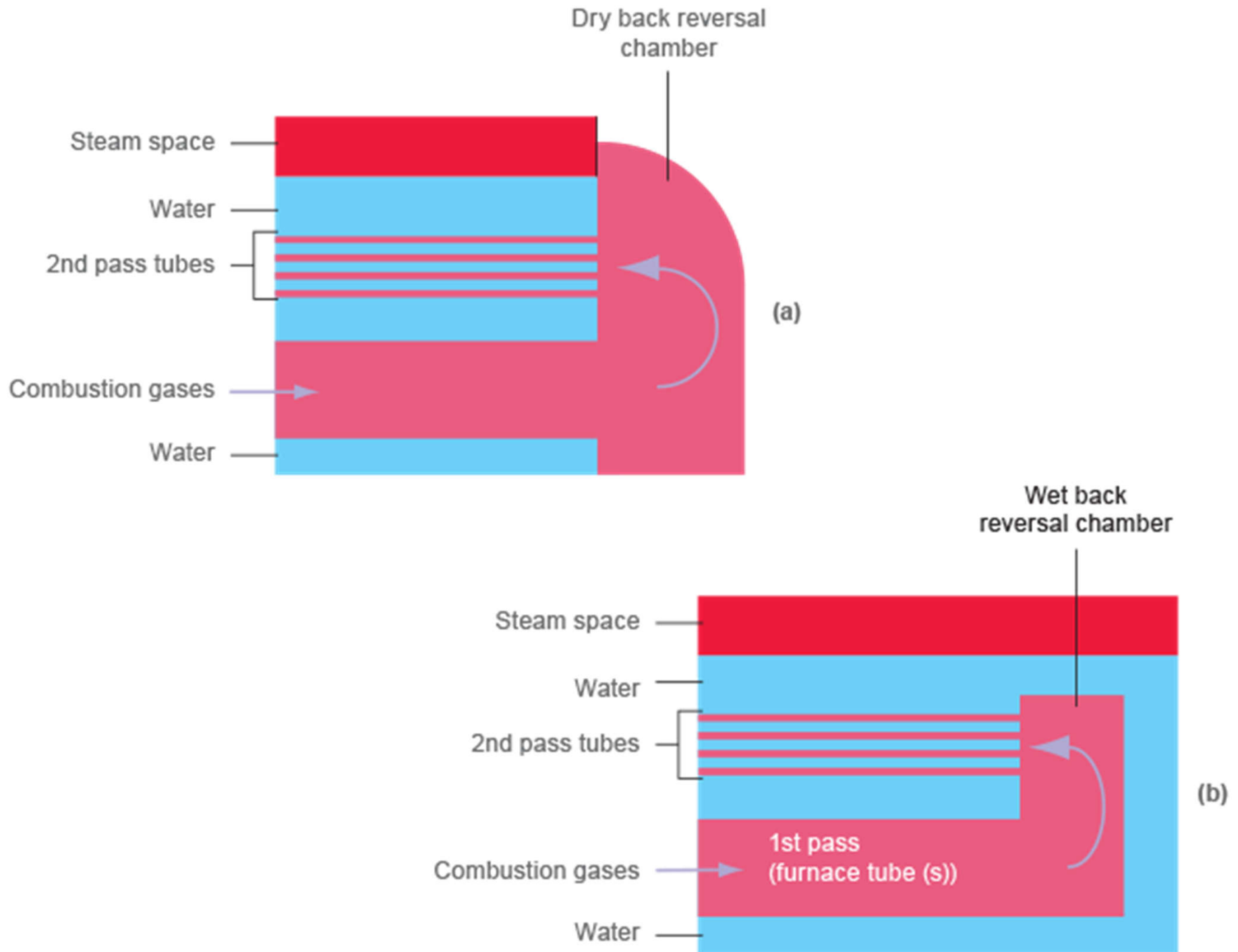

Lancashire boiler (first developed in 1844)

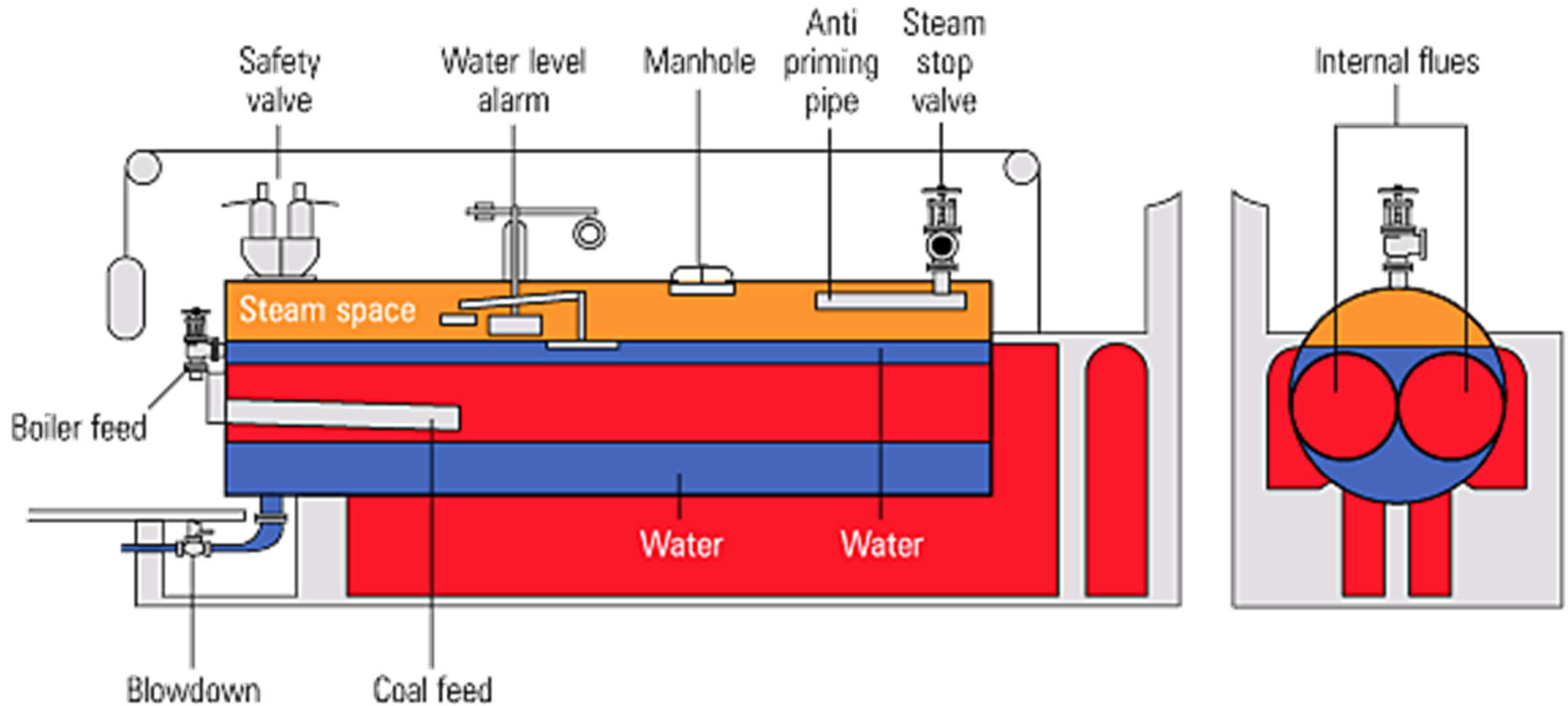

Capacity	Small	Large
Dimensions	5.5 m long x 2 m diameter	9 m long x 3 m diameter
Output	1 500 kg/h	6 500 kg/h
Pressure	Up to 12 bar g	up to 12 bar g

Economic boiler (two-pass, dry back)

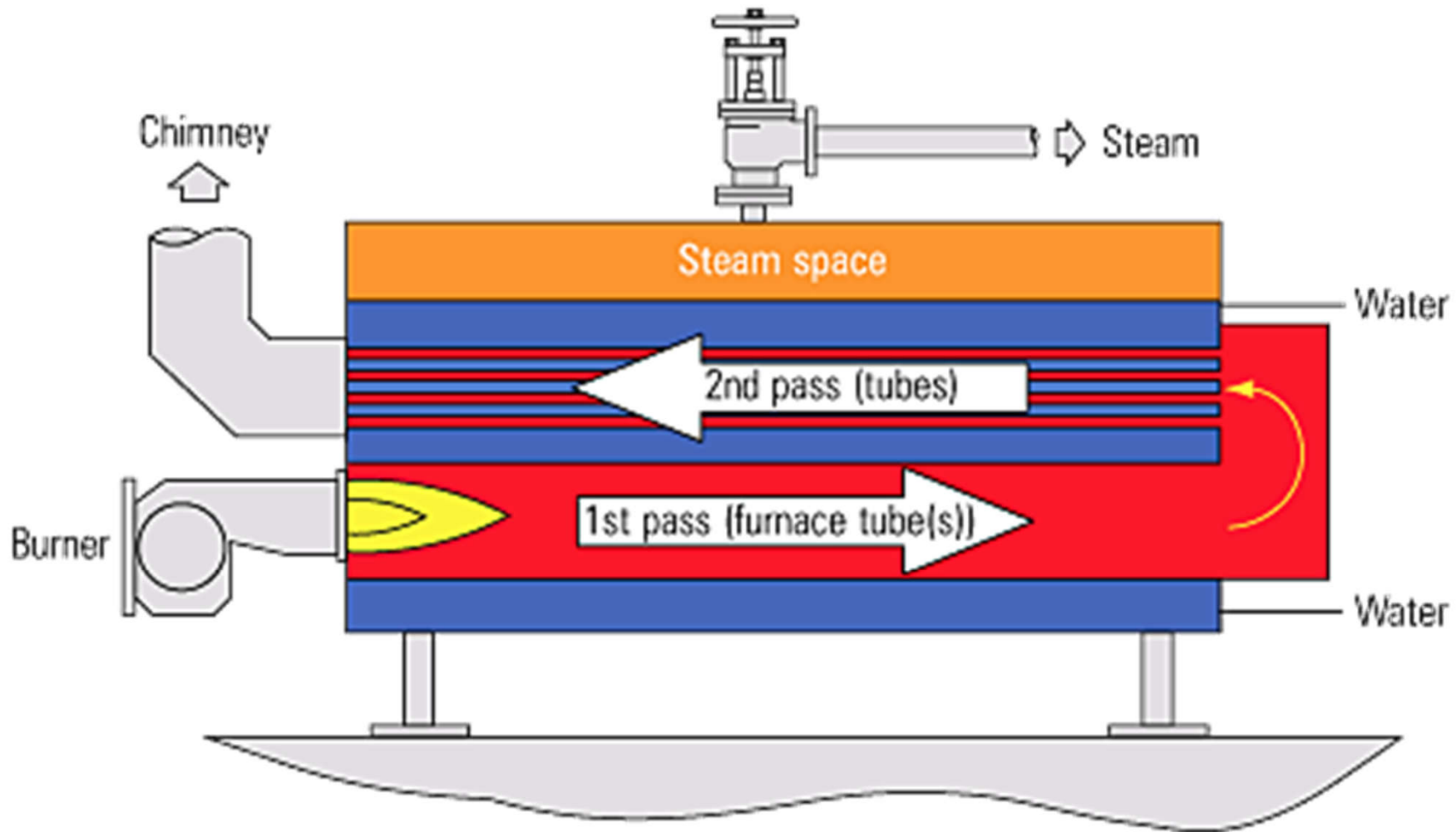

Capacity	Small	Large
Dimensions	3 m long x 1.7 m diameter	7 m long x 4 m diameter
Output	1 000 kg / h	15 000 kg / h
Pressure	Up to 17 bar g	up to 17 bar g

Economic boiler (three-pass, wet back)

Why Three Passes?

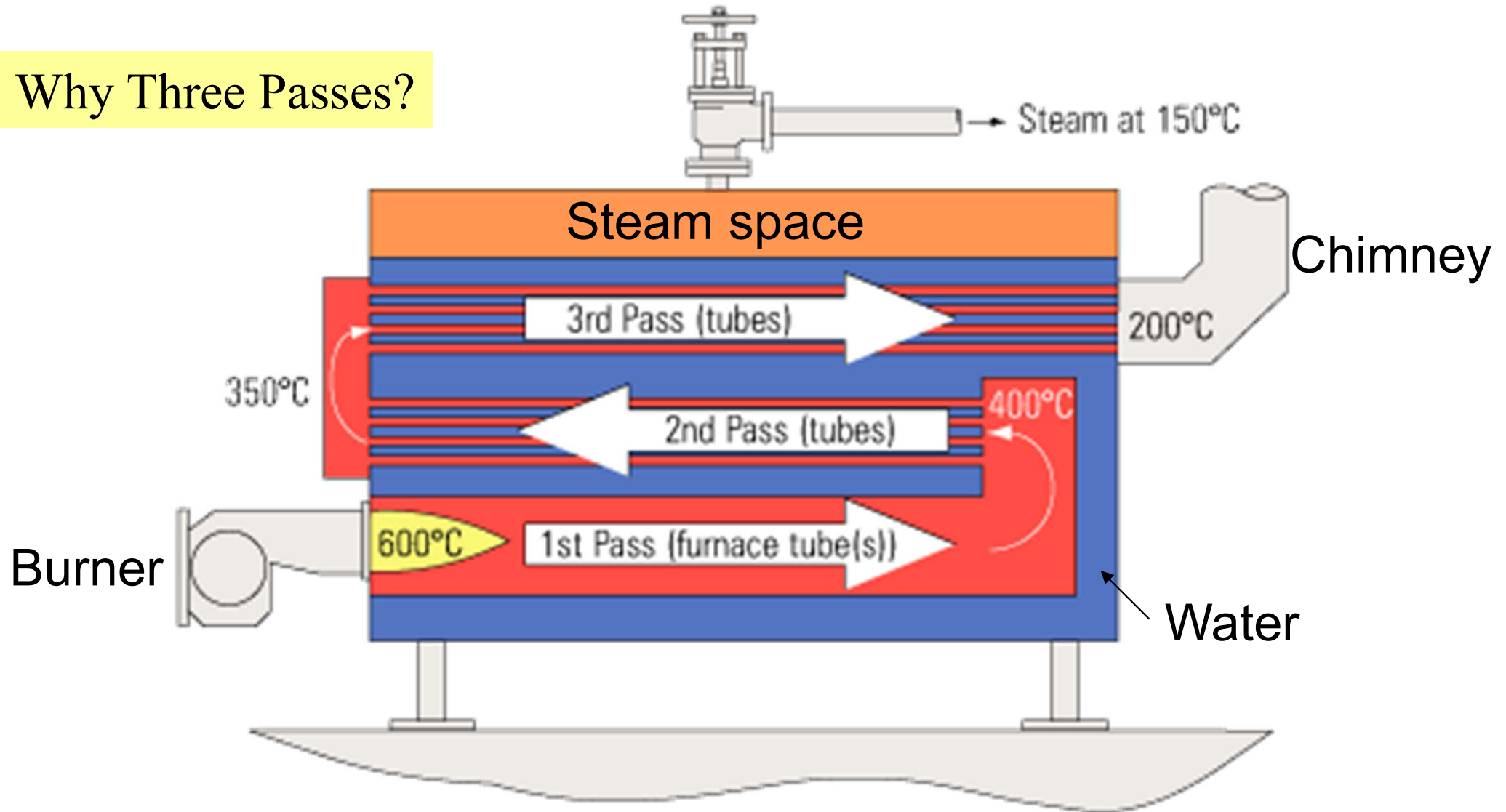

	Area of tubes	Temperature	Proportion of total heat transfer
1st pass	11 m ²	1 600°C	65%
2nd pass	43 m ²	400°C	25%
3rd pass	46 m ²	350°C	10%

Modern package boiler

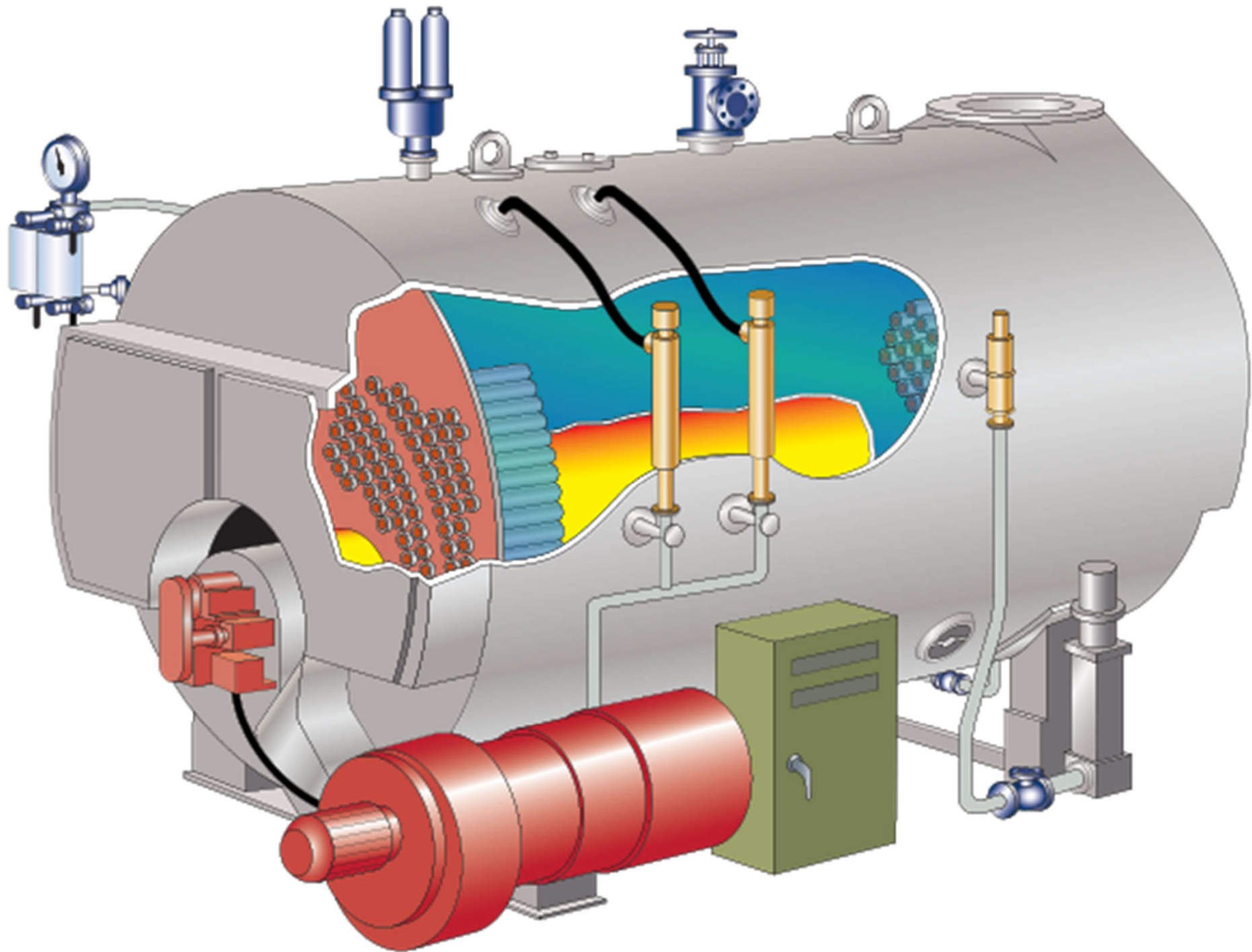

Comparison of 5,000 kg/h boilers

Boiler type	Fuel	Length (m)	Diameter (m)	Efficiency (%)	Volumetric heat release (kW/m ³)	Steam release rate from water Surface (kg/m ² s)
Lancashire	Coal	9.0	2.75	74	340	0.07
Economic	Coal	6.0	3.00	76	730	0.12
Packaged	Oil	3.9	2.50	82	2 330	0.20
Packaged	Gas	3.9	2.50	80	2 600	0.20

Boiler related standards (UK)

BS 2790	Specification for design and manufacture of shell boilers of welded construction.
BS 1113	Specification for design and manufacture of water-tube steam generating plant.
EN ISO 4126	Specification for safety valves for steam and hot water.
BS 759 Part 1	Specification for valves, mountings and fittings for steam boilers above 1 bar g.

Typical boiler level control/alarm configuration

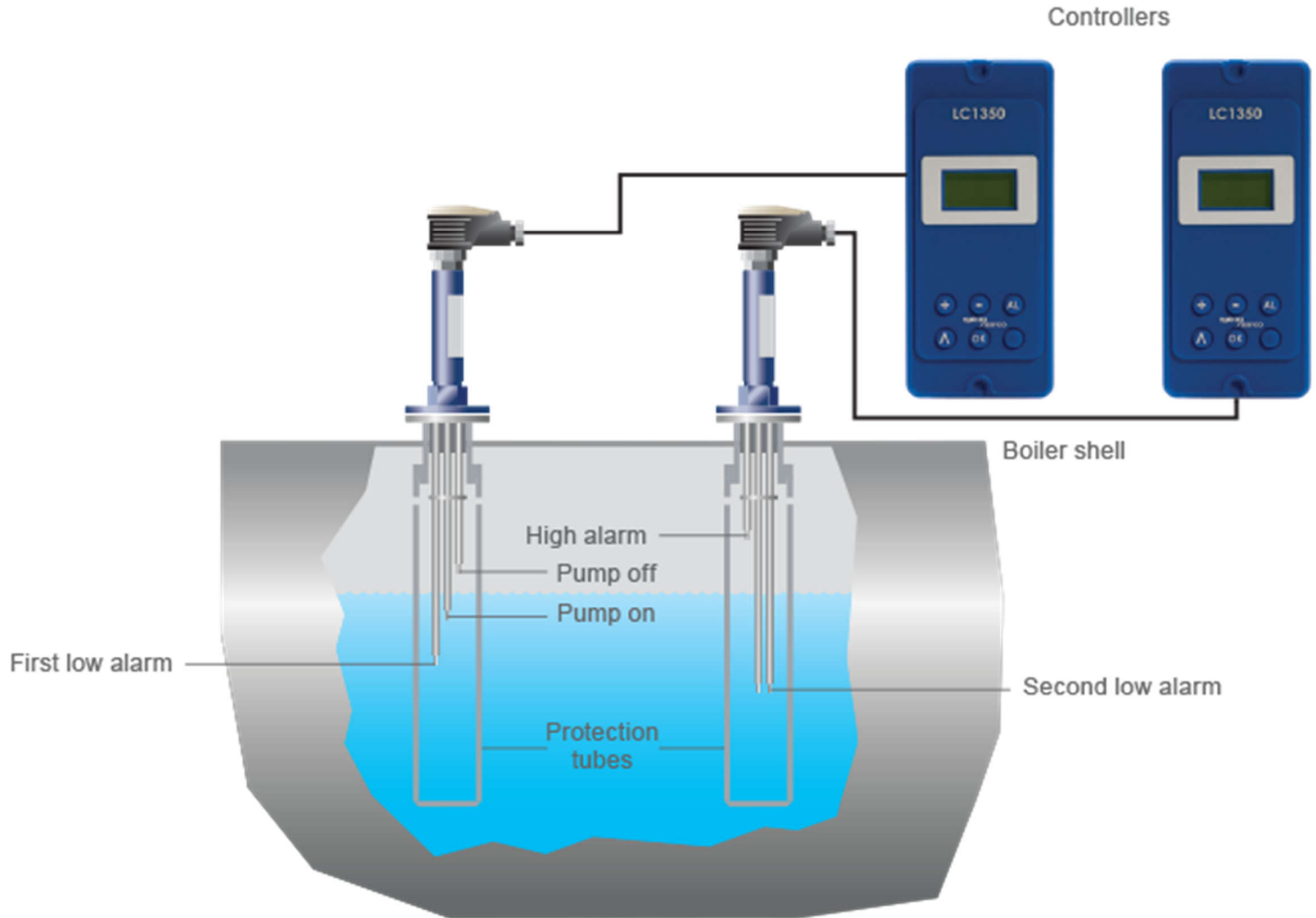

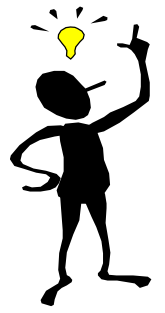

Design Considerations

- Design issues of steam-generating facility:
 - Type of application/load
 - Such as heating/cooling, process or combination
 - Operating conditions, requirements and constraints
 - Pressure, load profile & characteristics, steam quality, degree of superheat, condensate conditions
 - Facility requirements and limitations
 - Fuel type, stack gas, boiler room space, noise control
 - Codes and standards
 - Other government and local requirements

Summary of application/energy-use audit items for steam systems

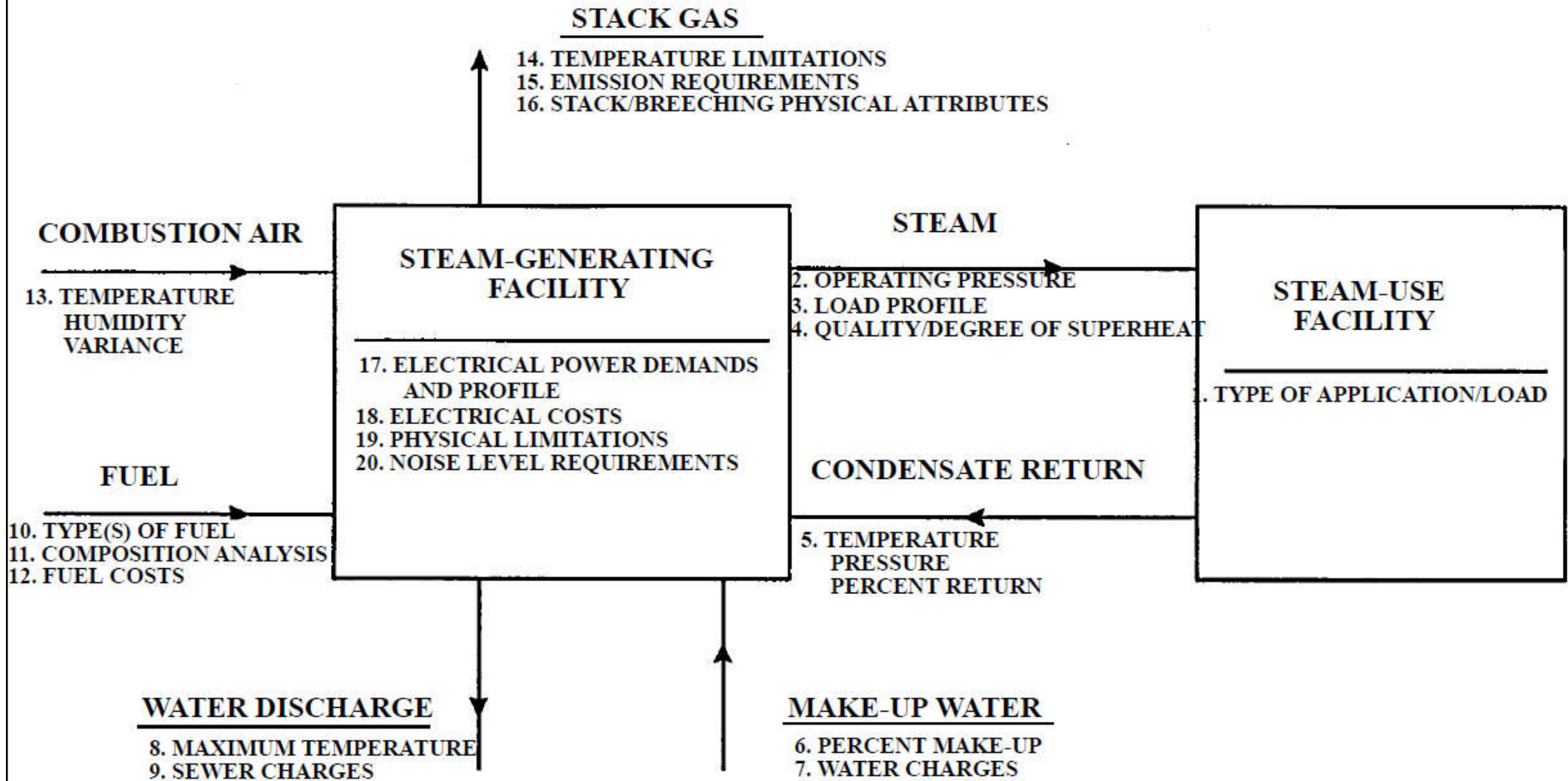

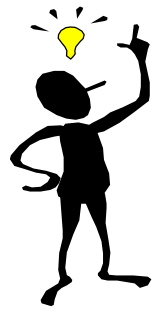

Design Considerations

- Methods of estimating steam consumption
 - To determine steam demand of the plant:
 - Calculation - By analysing the heat output on an item of plant using heat transfer equations
 - Measurement - Steam consumption may be determined by direct measurement, using flowmetering equipment
 - Thermal rating or design rating - It is often displayed on the name-plate of an individual item of plant, as provided by the manufacturers
 - For flow and non-flow applications. Including warm-up, heat losses and running load

Typical heat exchanger manufacturer's name-plate

⊕ XYZ Heat Exchanger Company ⊕														
Serial Number		HX12345												
Type and Size		AB12345												
Pressures		<table border="1"><thead><tr><th></th><th>Design</th><th>Test</th></tr></thead><tbody><tr><td>Shell</td><td>10.0 bar g</td><td>15.0 bar g</td></tr><tr><td>Tube</td><td>17.0 bar g</td><td>25.5 bar g</td></tr><tr><td>NWP</td><td>14.0 bar g</td><td></td></tr></tbody></table>		Design	Test	Shell	10.0 bar g	15.0 bar g	Tube	17.0 bar g	25.5 bar g	NWP	14.0 bar g	
		Design	Test											
	Shell	10.0 bar g	15.0 bar g											
Tube	17.0 bar g	25.5 bar g												
NWP	14.0 bar g													
Main shell thickness		5 mm												
Date of hydraulic test		1985												
Design code - shell		BS 853												
Design code - tubes		BS 853												
Design rating		250 kW												

$$\text{Steam flowrate (kg/h)} = \frac{\text{Load in kW} \times 3\,600}{h_{fg} \text{ at operating pressure}}$$

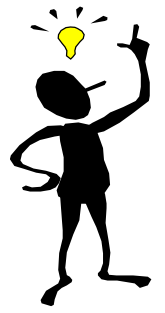

Design Considerations

- Steam Engineering Principles and Heat Transfer (Learn about steam)
 - <https://www.spiraxsarco.com/Learn-about-steam>
 - 6. Methods of Estimating Steam Consumption
 - 9. Energy consumption of tanks and vats
 - 10. Heating with coils and jackets
 - 11. Heating vats and tanks by steam injection
 - 12. Steam Consumption of Pipes and Air Heaters
 - 13. Steam Consumption of Heat Exchangers
 - 14. Steam Consumption of Plant Items

Design Considerations

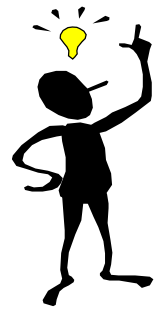

- Safety precautions [c.f. water heater at home]
 - 4 possible arrangements for burner safety control
 - Automatic recycling
 - Automatic non-recycling
 - Manual
 - Supervised manual
 - Purge and startup
 - Flame failure protection
 - Water level alarms and cut-off
 - Interlocks





Design Considerations

- Regulations in Hong Kong
 - Boilers and Pressure Vessels Ordinance (Cap 56)
 - Enforced by Boilers & Pressure Vessels Division, Labour Department
 - Fossil-fuel boilers, electric steam boilers
 - Relevant guide books and codes of practices
 - https://www.labour.gov.hk/eng/public/content2_10.htm
 - Accidents of boilers and pressure vessels in HK
 - See reference books from Labour Department

Accidents did happen in HK before !

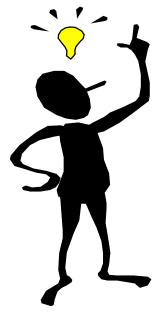

Design Considerations

- Regulations in Hong Kong (cont'd)
 - Basic requirements:
 - Registration of boilers/pressure vessels
 - Employ a qualified person with “Certificate of Competency” to operate the boiler / steam receiver
 - Engage an “Appointed Examiner”
 - Periodic examination & “Certificate of Fitness”
 - Notify the Authority of sale, hiring or removal of the boiler/pressure vessel
 - Notify the Authority of any accidents and defects
 - Examination after extensive repair



Steam pipeline

- Efficient steam distribution system:
 - Steam of the right quality and pressure is to be supplied, in the right quantity, to the steam using equipment
- Major issues of steam system design
 - Sufficient pressure difference
 - Pipeline velocity
 - Condensate return
 - Safety issues
 - Testing & commissioning
 - Operation & maintenance

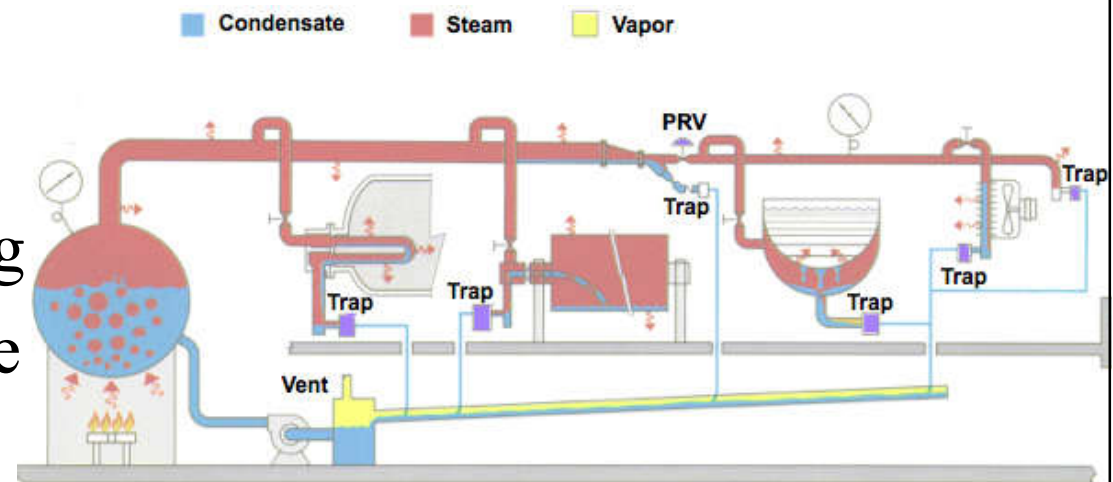



Steam pipeline

- Steam pipe sizing
 - Info. required:
 - Initial or final steam pressure, temperature & quality
 - Steam flow rate
 - Length of the pipe
 - Permissible pressure drop
 - Permissible velocity of flow
 - The pipe size may be selected on the basis of:
 - Velocity (usually pipes less than 50 m in length)
 - Pressure drop (should not normally exceed 0.1 bar/50 m)

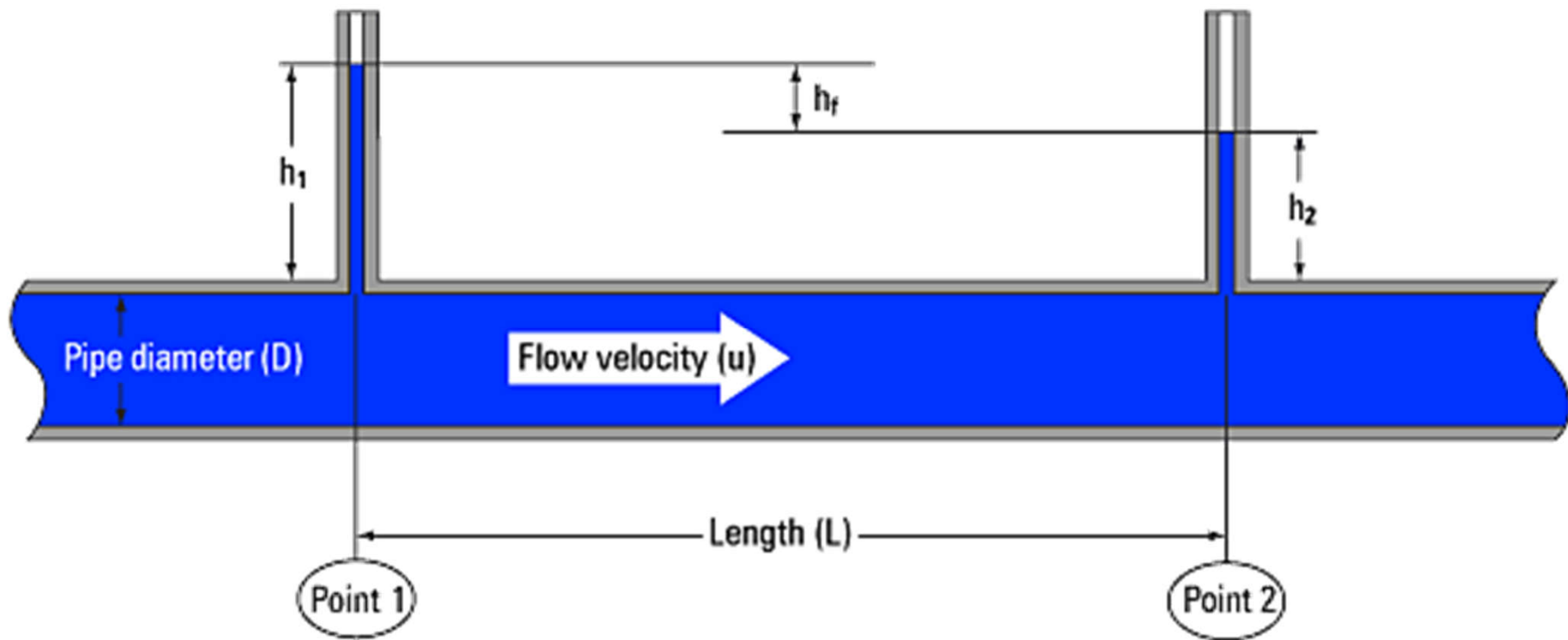

D'Arcy equation:
$$h_f = \frac{f \cdot L \cdot u^2}{2 \cdot g \cdot D}$$

where h_f = head loss to friction (m)

f = friction factor (dimensionless)

L = length (m)

u = flow velocity (m/s)

g = gravitational constant (9.81 m/s^2)

D = pipe diameter (m)

Steam pipeline



- Steam pipe sizing (cont'd)
 - Friction factor can be difficult to determine, especially for turbulent steam flow. As a result, some graphs, tables and slide rules are produced to relate steam pipe sizes to flowrates and pressure drops, e.g. the “pressure factor” method:
 - $F = (P_1 - P_2) / L$
 - F = pressure factor
 - P_1 = factor based on the inlet pressure
 - P_2 = factor based on the pressure at a distance of L metres
 - L = equivalent length of pipe (m)



Steam pipeline

- Permissible pressure drop & flow velocity are affected by several factors:
 - Relative direction of steam & condensate flow within the same pipe
 - Whether the pipe is vertical, horizontal or sloping down in the direction of steam flow or against it
 - Steam quality & erosive action of wet steam on valve seats
 - Possibility of carry-over of water droplets from boiler steam spaces & flash steam vessels
 - Permissible noise level



Steam pipeline

- Best practices for condensate removal on steam lines
 - 1. Choose trap locations carefully
 - 2. Provide proper support & inclined steam piping
 - 3. Pay attention to drip leg (drain pocket) configuration
 - 4. Properly remove air and condensate at end of steam line

Typical steam main & branch line installation

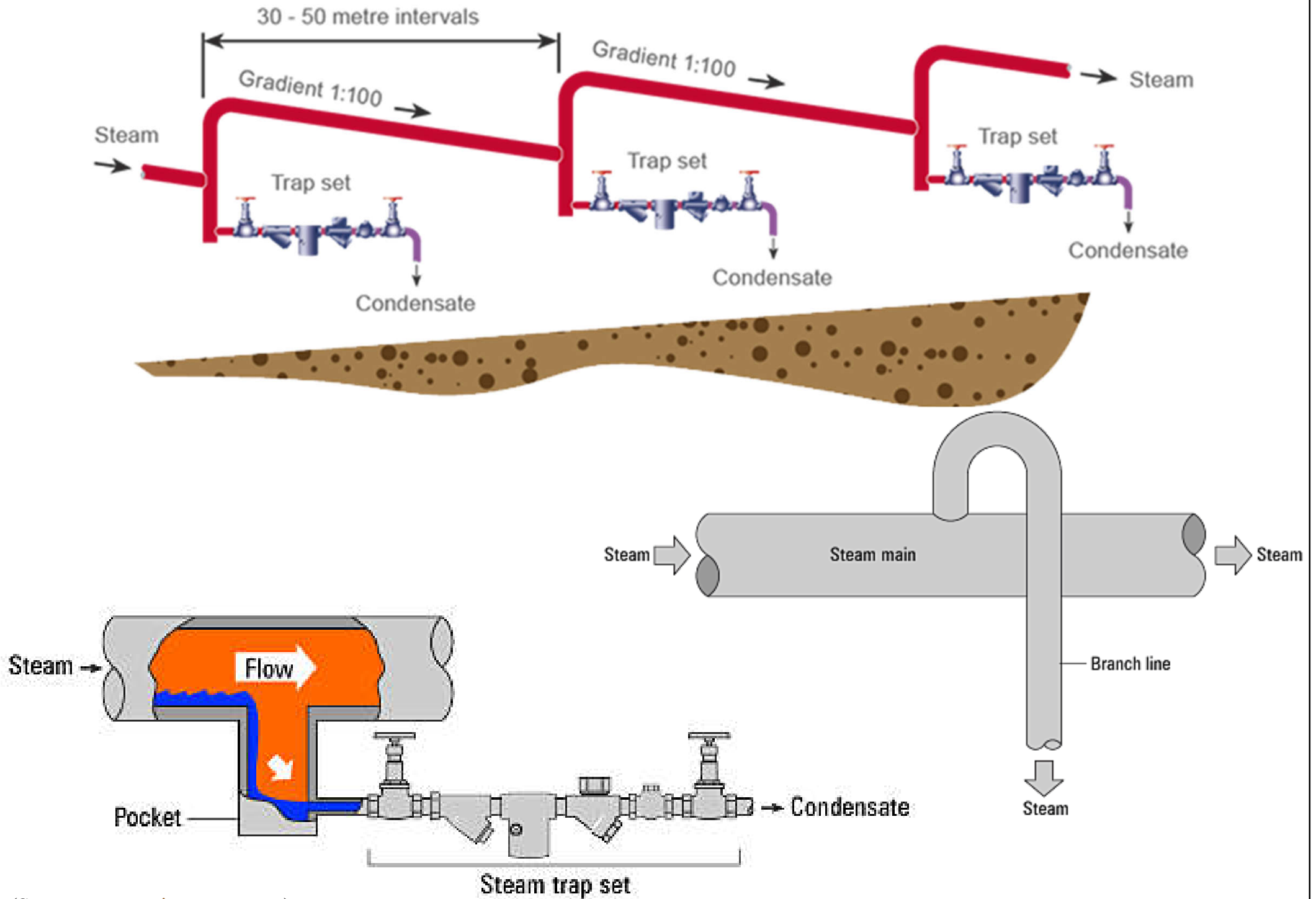

Installation tips for steam traps on steam mains

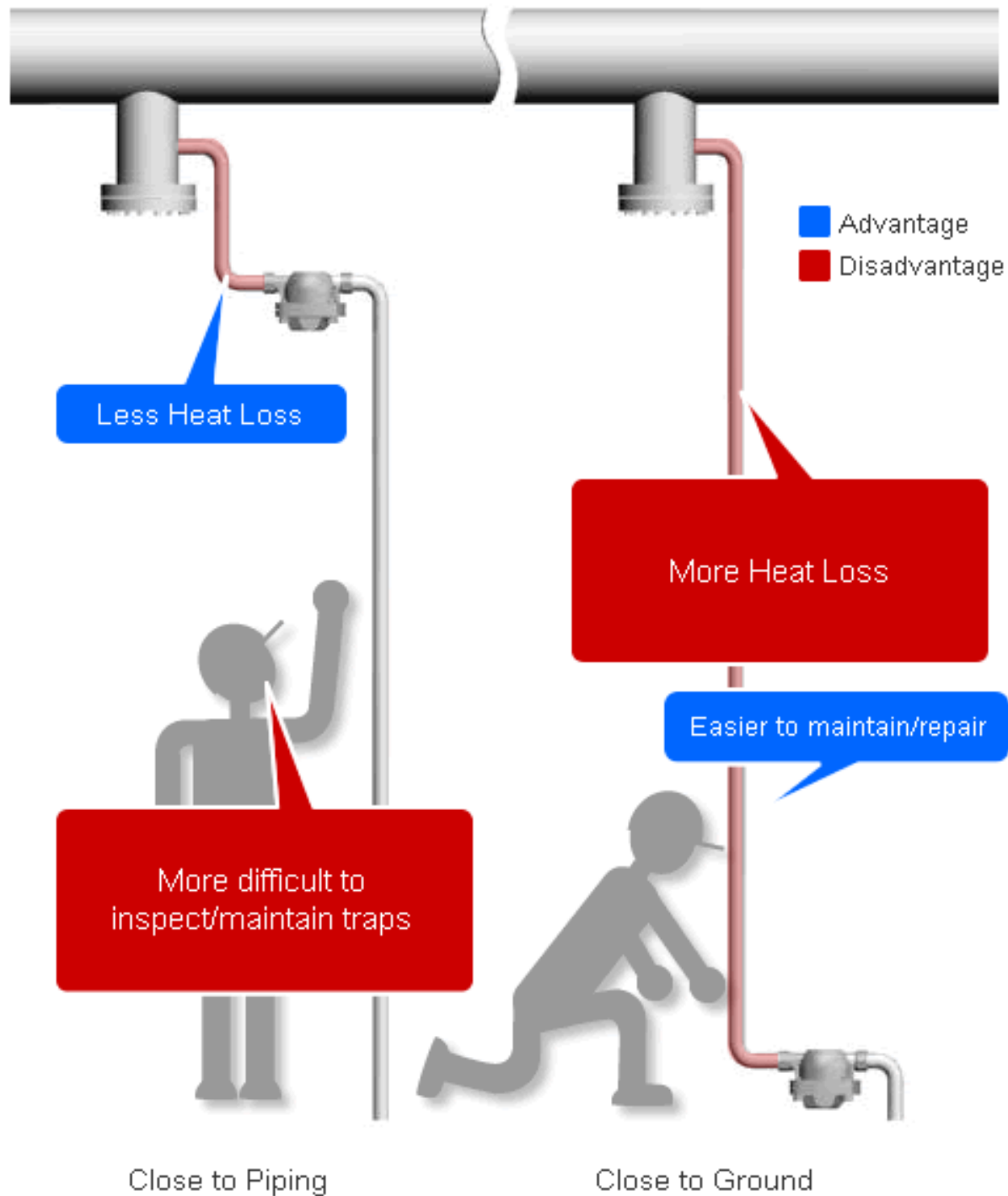

Installation tips for steam traps on steam mains (cont'd)

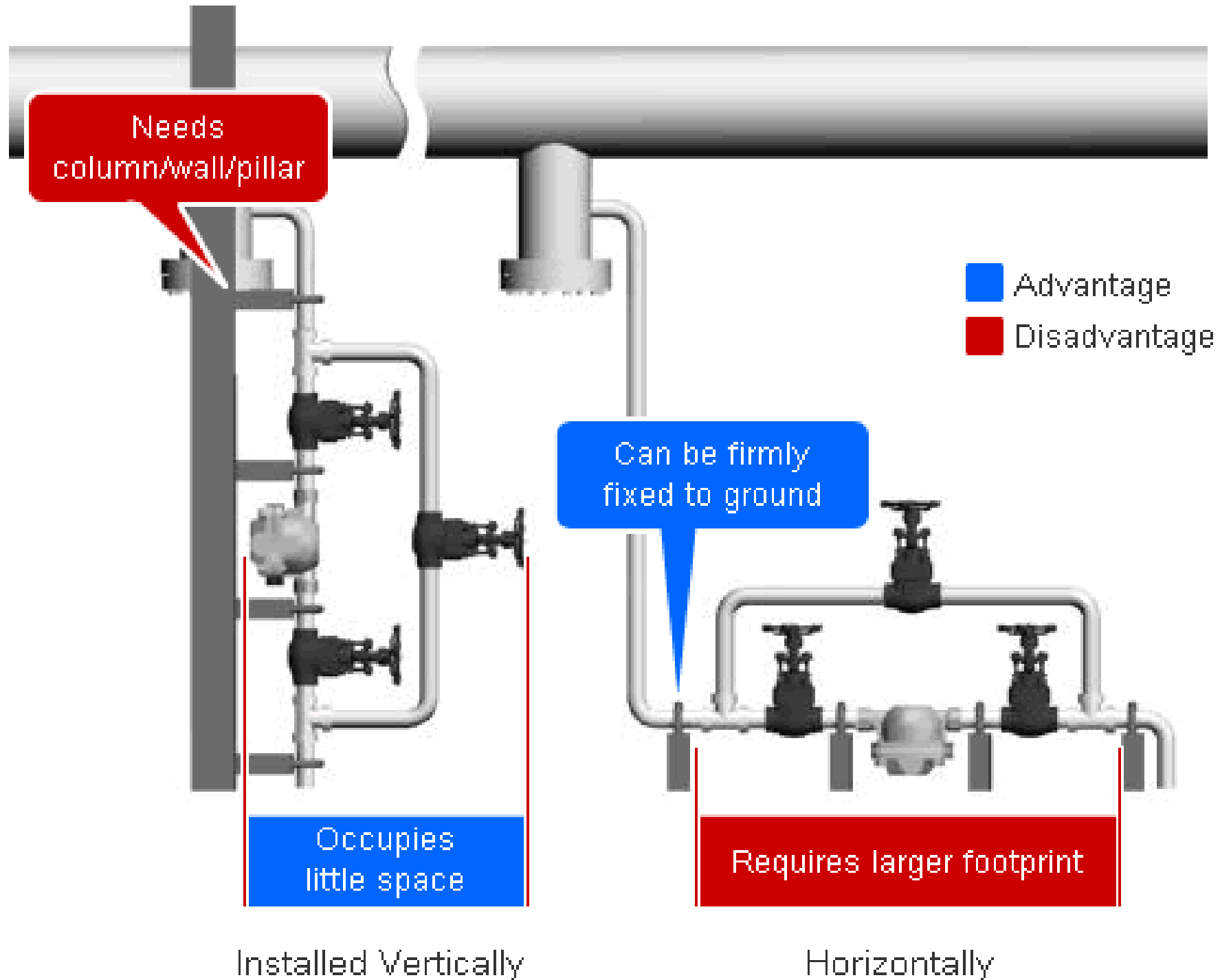



Steam pipeline

- Installation of steam and condensate pipes
 - Analyse most economic thickness for pipe thermal insulation
 - Expansion joints or loops to relieve stresses due to expansion and contraction
 - Provided with a fall of about 1 in 300
 - Provided with drainage outlet at low points
 - Suitable pipe support spacing, bracket and method

Pipe expansion and support

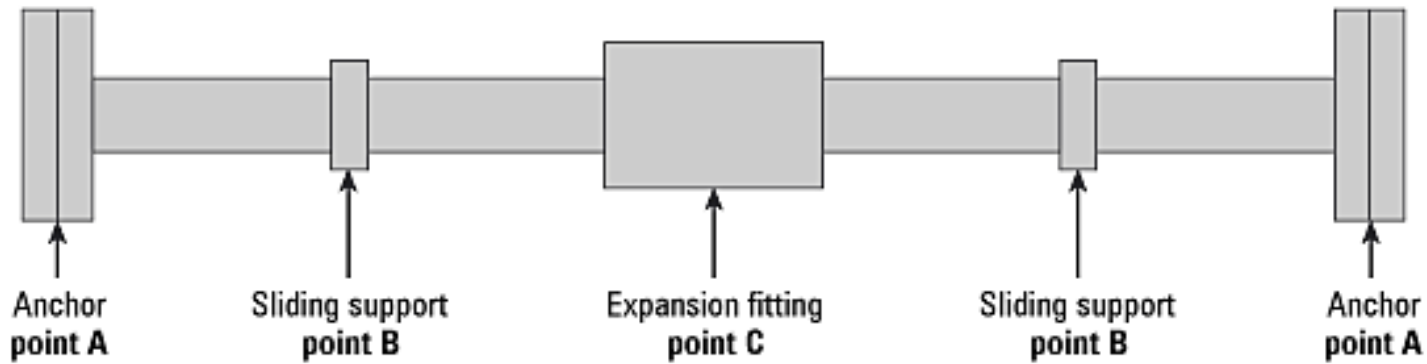

Pipeline with fixed point, variable anchor point and expansion fitting

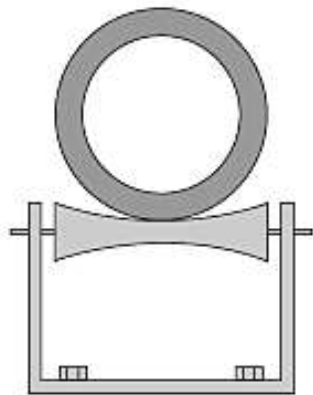

Chair and roller

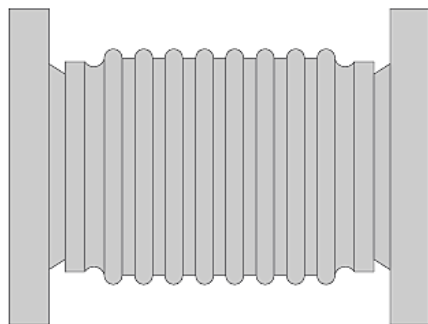

Expansion bellow

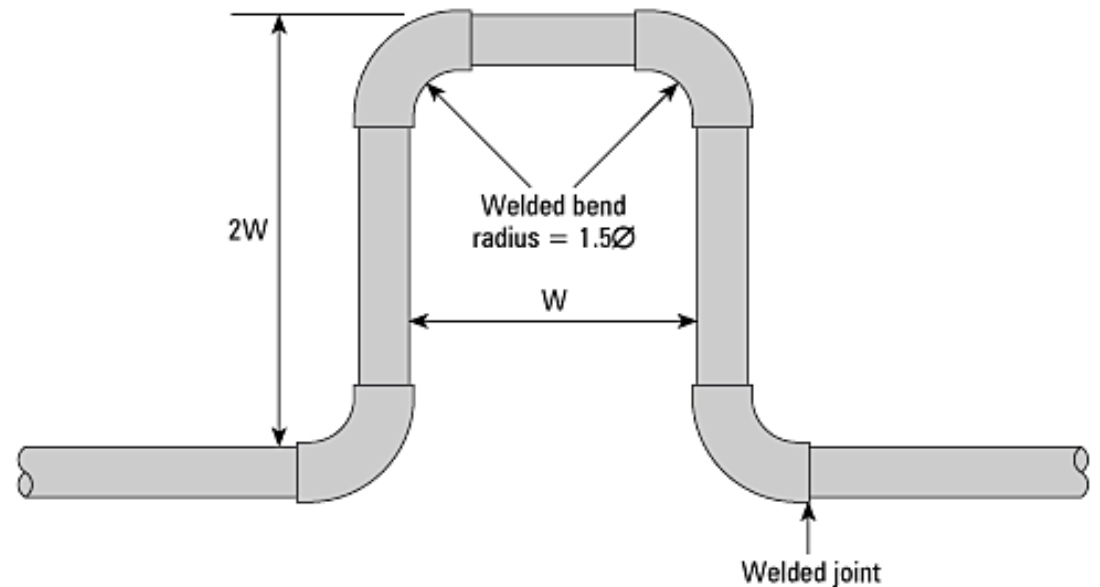

Expansion loop

Recommended support spacing for steam pipework

Nominal pipe size (mm)		Interval of horizontal run (metre)		Interval of vertical run (metre)	
Steel bore	Copper outside diameter	Mild steel	Copper	Mild steel	Copper
	15		1.2	2.4	1.8
15		1.8		3.0	
20	22	2.4	1.2	3.0	1.8
25	28	2.4	0.5	3.0	2.4
32	35	2.4	1.8	3.7	3.0
40	42	2.4	1.8	3.7	3.0
50	54	2.4	1.8	4.6	3.0
65	67	3.0	2.4	4.6	3.7
80	76	3.0	2.4	4.6	3.7
100	108	3.0	2.4	5.5	3.7
125	133	3.7	3.0	5.5	3.7
150	159	4.5	3.7	5.5	
200		6.0		8.5	
250		6.5		9.0	
300		7.0		10.0	

Steam distribution manifold

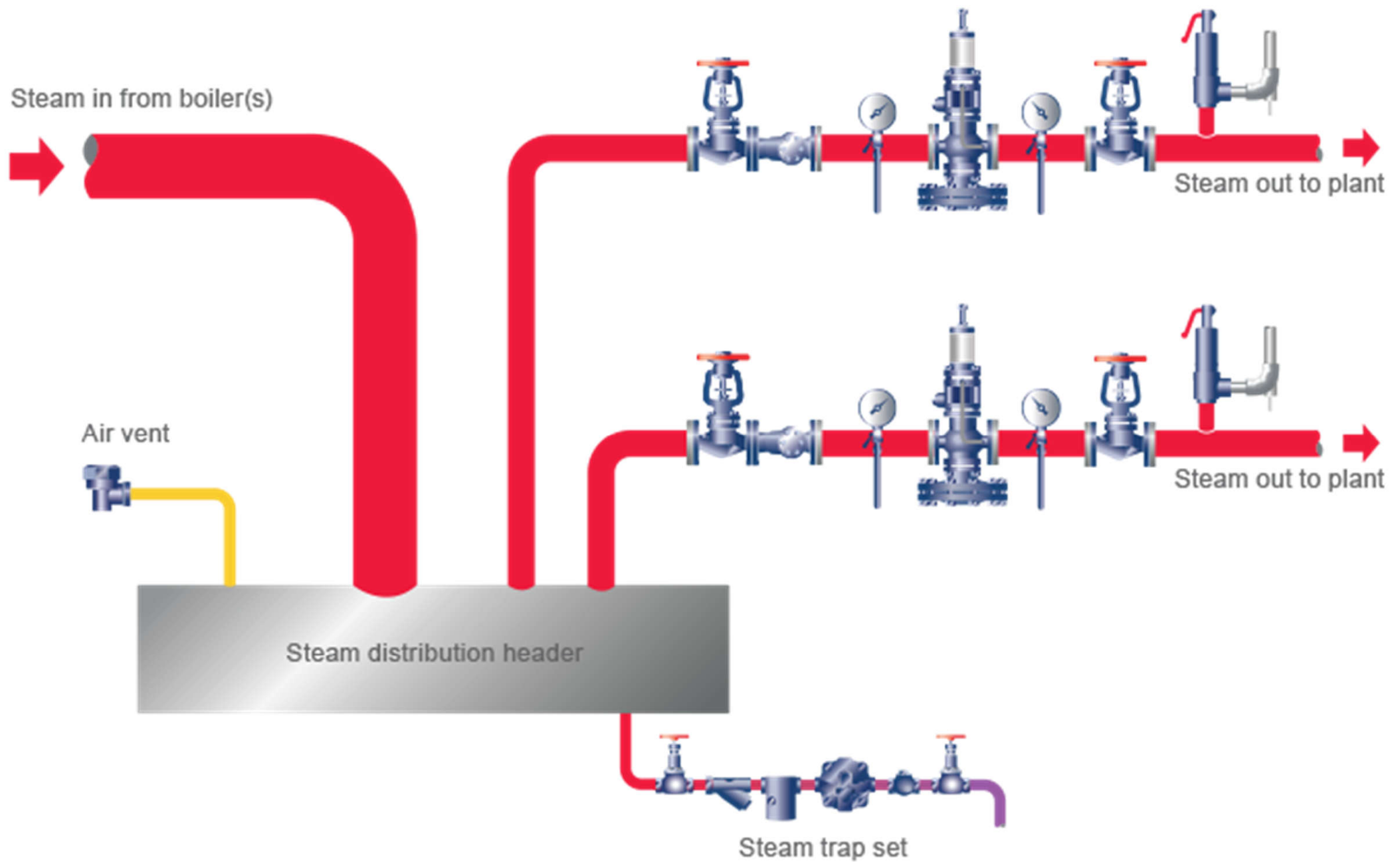

Steam pipeline



- Erosion and corrosion in the piping
 - Erosion -- gradual wearing away of a solid through abrasion
 - Physical degradation of a material due to the flow of water, wind, or debris; e.g. caused by liquid droplet impingement or high velocity dis-entrained condensate
 - <https://www2.tlv.com/en-au/steam-info/steam-theory/problems/piping-erosion>
 - Corrosion -- degradation of a material caused by chemical reactions
 - <https://www2.tlv.com/en-au/steam-info/steam-theory/problems/corrosion>

Examples of corroded pipes





Condensate recovery

- Importance of condensate recovery
 - Returned to the boiler for reuse as feed-water
 - Can increase heat efficiency of the cycle
 - Can reduce make-up water charges
 - Can reduce effluent charges and possible cooling costs
 - Can keep water-treatment problems to a minimum
 - Can reduce boiler blowdown (less energy is lost)
- Start-up load: initial warm up of components
 - Highest steam consumption
- Running load: fairly stable condition

Condensate Recovery

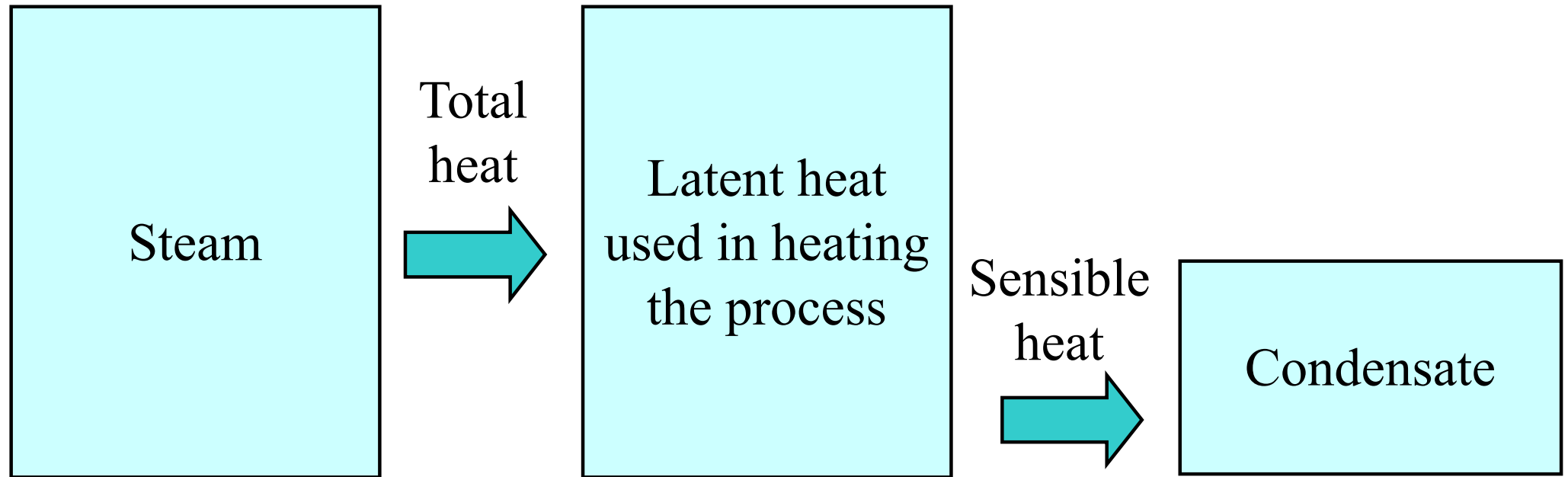

After giving up its latent heat to heat the process, steam turns to water containing only sensible heat



Condensate recovery

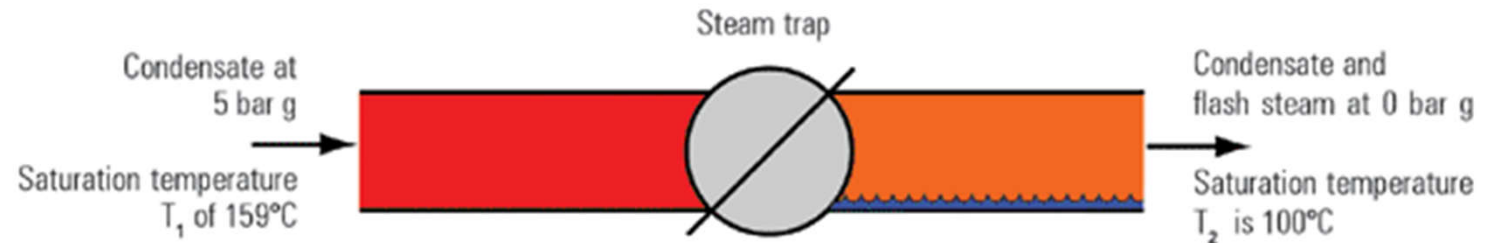

- Flash steam

- Formed when high pressure condensate is discharged to a lower pressure (“flash evaporation”) (same as live steam)
- Should be collected and led to a flash vessel (for reuse)
- Other important issues:
 - Suitable collecting legs or reservoirs for condensate
 - Minimum pressure differential across the steam trap
 - Choice of steam trap type and size
 - Proper trap installation

Example: Calculate the amount of flash steam from condensate.

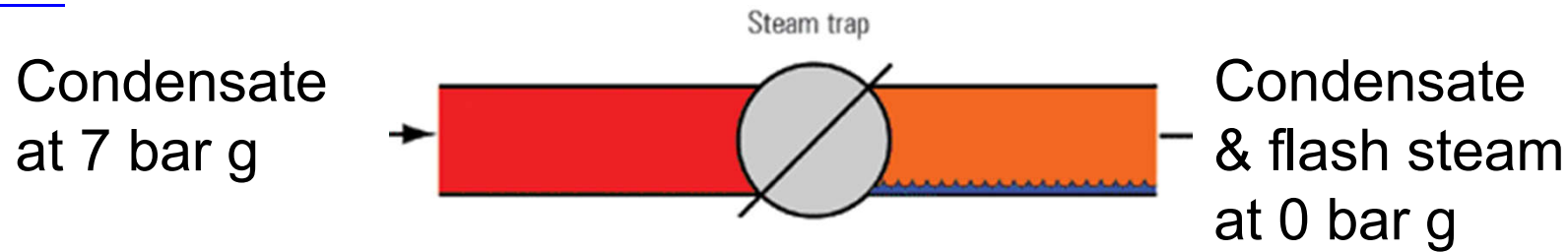

Hot condensate at 7 bar g has a heat content of 721 kJ/kg. When it is released to atmospheric pressure (0 bar g), each kilogram of water can only retain 419 kJ of heat.

The excess energy in each kg of the condensate is $721 - 419 = 302$ kJ
This excess energy is available to evaporate some of the condensate into steam.

If the enthalpy of evaporation at atmospheric pressure is 2258 kJ/kg, then the percentage of flash steam evaporated is $= 302 / 2258 \times 100\%$

Thus, flash steam evaporated = **13.4%**
(can be reused by flash steam recovery systems)

(See also: Engineering Calculator -- Flash Steam Generated by Hot Condensate
<http://www.tlv.com/global/AU/calculator/flash-steam-generation.html>)



Condensate recovery

- **Condensate** can be reused in many different ways, for example:
 - As heated feedwater, by sending hot condensate back to the boiler's deaerator
 - As pre-heat, for any applicable heating system
 - As steam, by reusing flash steam
 - As hot water, for cleaning equipment or other cleaning applications
- **Condensate Recovery vs. No Recovery**

Using a flash vessel to return energy to the boiler feedtank

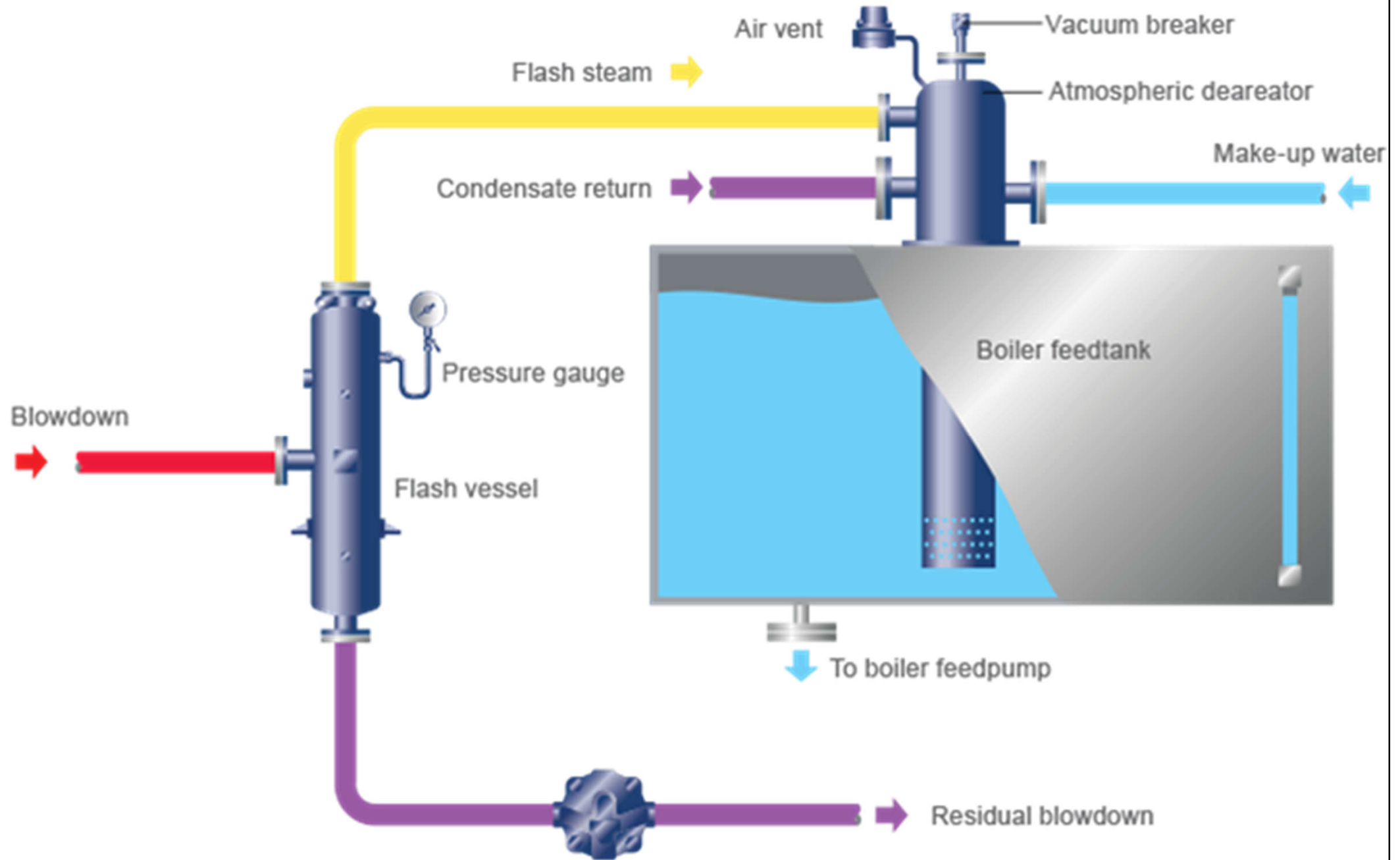

A simple steam system with condensate returning to the boiler feedtank

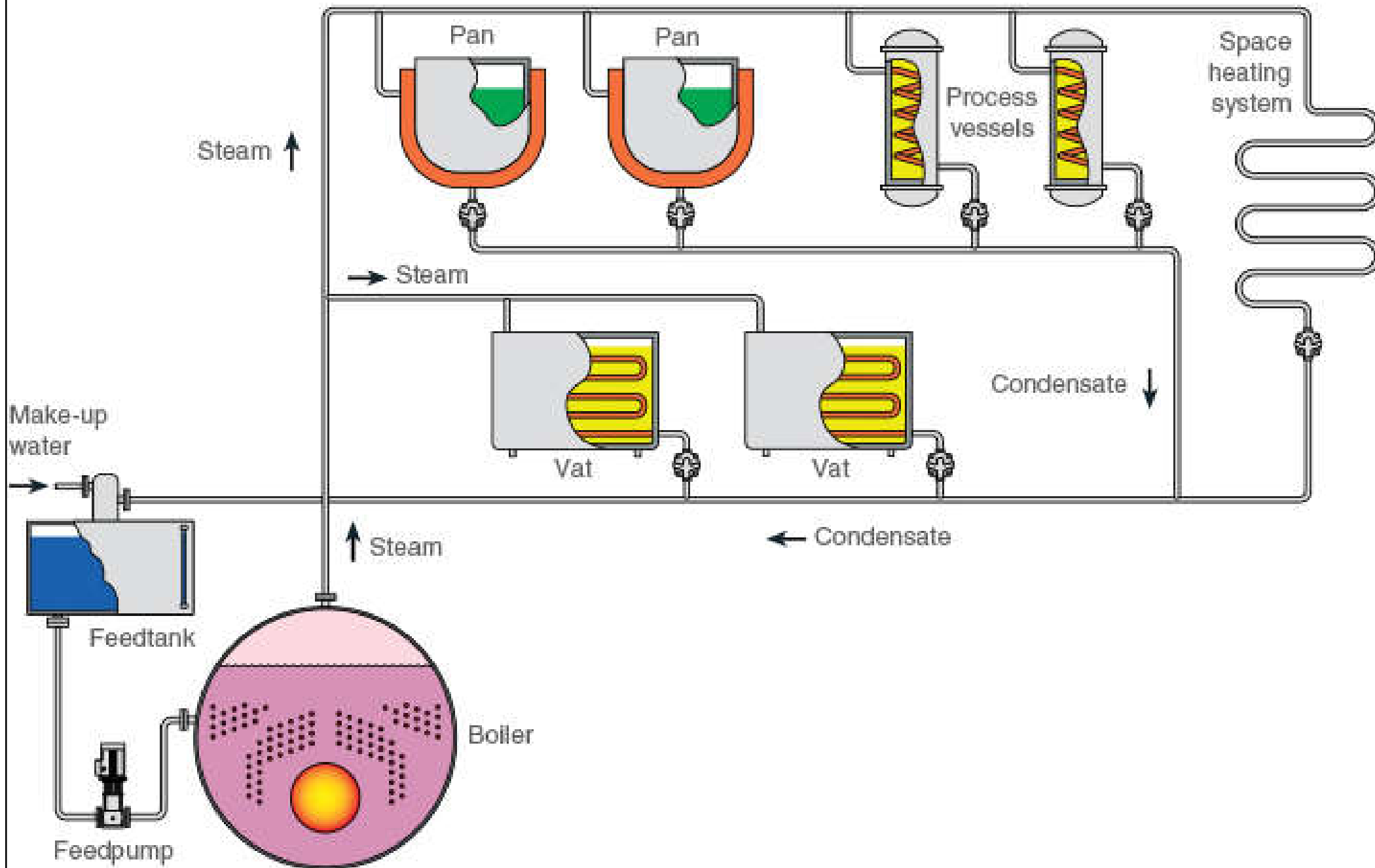

Four basic types of condensate piping and their considerations

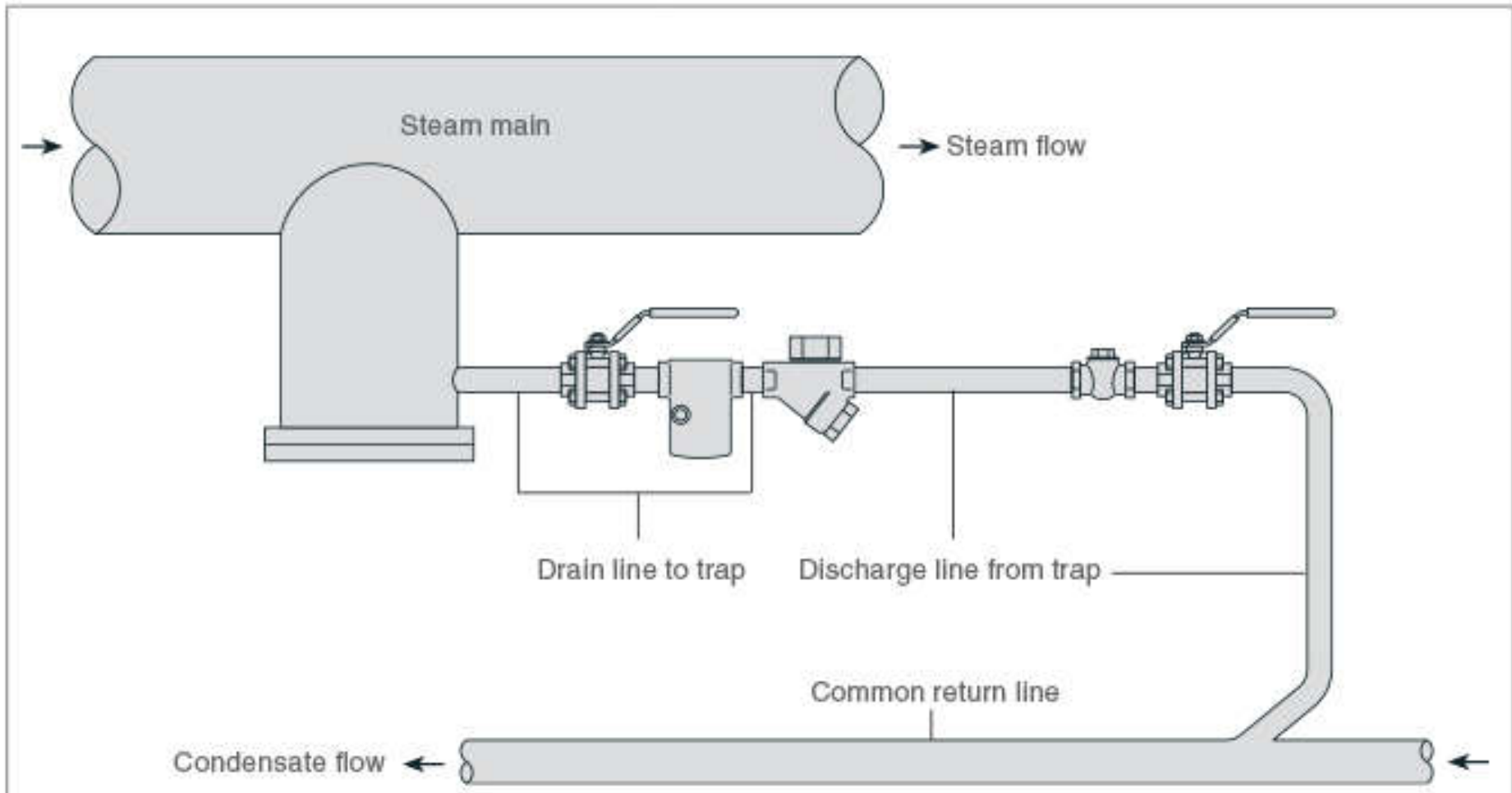

Type of condensate line	Condensate line is sized to carry the following:
Drain line to trap	Condensate
Discharge line from trap	Flash steam
Common return line	Flash steam
Pumped return line (not shown)	Condensate

Ideal arrangement when draining a steam main

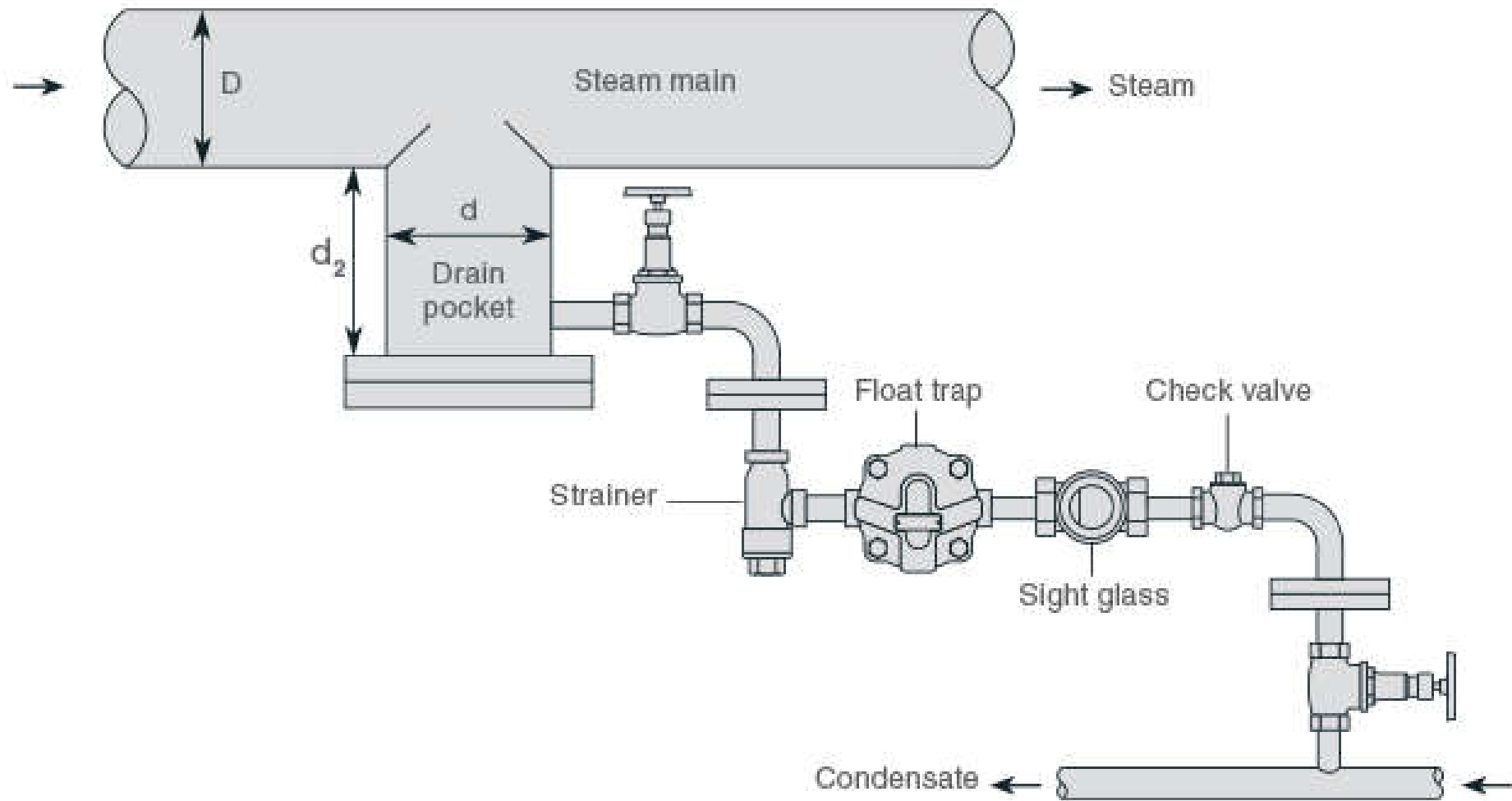

Main diameter D	Pocket diameter d_1	Pocket depth d_2
Up to 100 mm	$d_1 = D$	Minimum $d_2 = 100$ mm
125 mm - 200 mm	$d_1 = 100$ mm	Minimum $d_2 = 150$ mm
250 mm and above	$d_1 = D/2$	Minimum $d_2 = D$



Condensate recovery

- Returning condensate and condensate pumps
 - Use trap inlet pressure
 - Gravity return
 - Elevated return
 - Use a pump to overcome return line backpressure
 - Electric centrifugal or turbine condensate pumps
 - Non-electric steam or air-powered mechanical condensate pumps
 - Using a specialized centrifugal pump for condensate recovery pumps



Condensate recovery

- Condensate recovery: vented vs. pressurized
 - Vented
 - Return condensate to an open-to-atmosphere collection tank for use as boiler make-up water, pre-heat or other hot water applications
 - Pressurized
 - In a pressurized vessel/directly to the boiler
 - Recovered condensate is maintained above atmospheric pressure throughout the recovery process
 - It is generally used as boiler make-up water
 - Can also recover the associated flash or live steam

Typical range for vented / pressurized systems

Vented Recovery System

Condensate Pressure

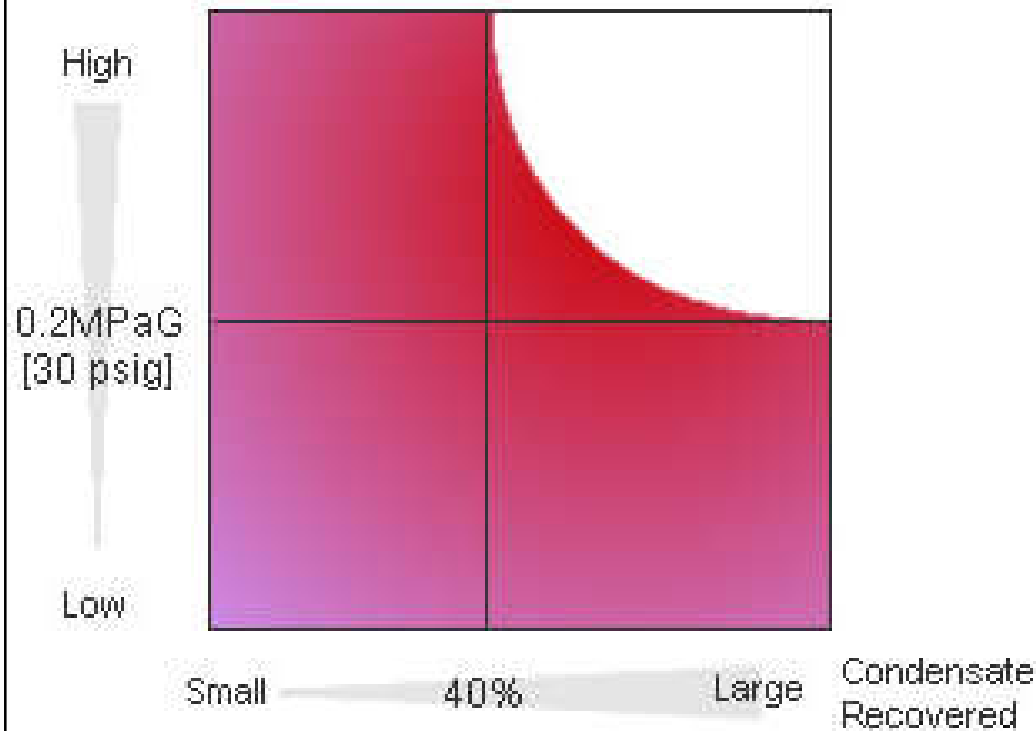

Return on Investment

More Limited  Greater

Pressurized Recovery System

Condensate Pressure

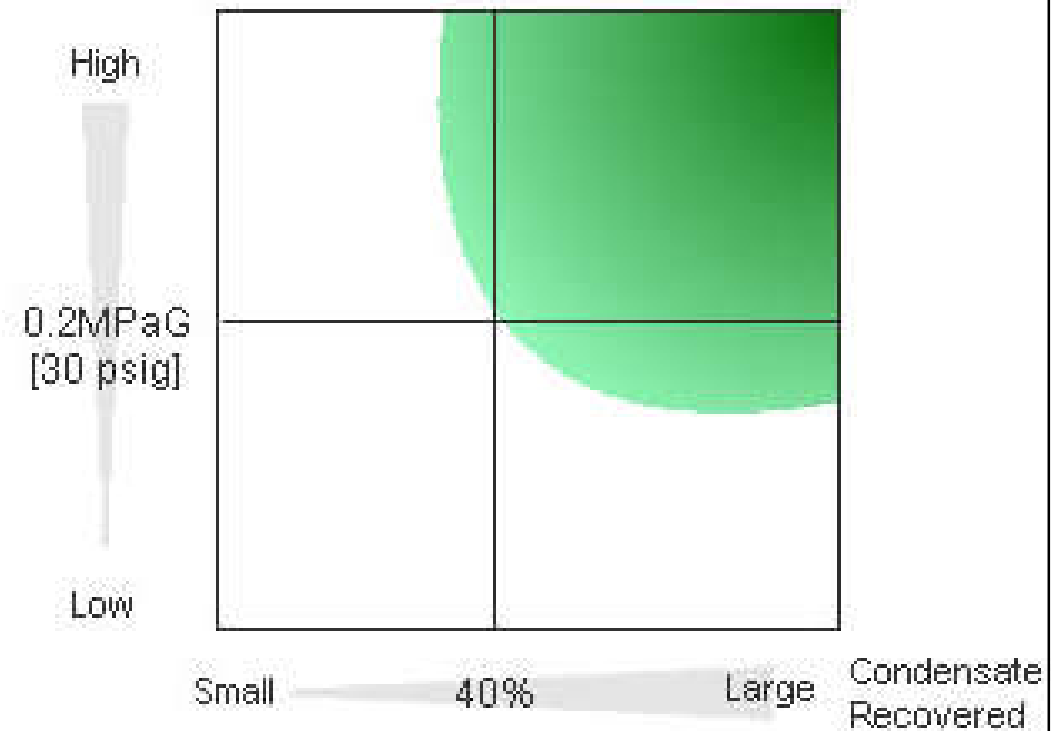

Return on Investment

More Limited  Greater

Condensate recovery: vented vs. pressurized systems

	Vented Recovery	Pressurized Recovery
Recovered Condensate Temperature	Up to 100 °C [212 °F]	Up to 180 °C [356 °F]*
System Configuration	Simple	Advanced
Initial Costs	Lower	Higher
Running Costs	Varies	Varies
Piping Corrosion	Significant (condensate comes into contact with air)	Slight (no contact with air)
Vapor Clouds	Large amount (if condensate temp. is high)	Minimal amount
Recovery Applications	Boiler make-up water Pre-heat Water for cleaning, etc.	Mainly for direct feed to boiler, and Flash Steam Recovery Applications

* May be higher. Limited by max operating temperature of pump and peripheral equipment.



Condensate recovery

- Condensate recovery/return piping
 - Must be designed for “two-phase flow”
 - Vapour such as steam (either flash steam, live steam, or a mix of both) flows through piping together with liquid condensate
 - The design requires calculating the amount of flash steam and then sizing the pipe to accommodate both water and steam flow for the required velocity and pressure drop design parameters

Condensate recovery and return

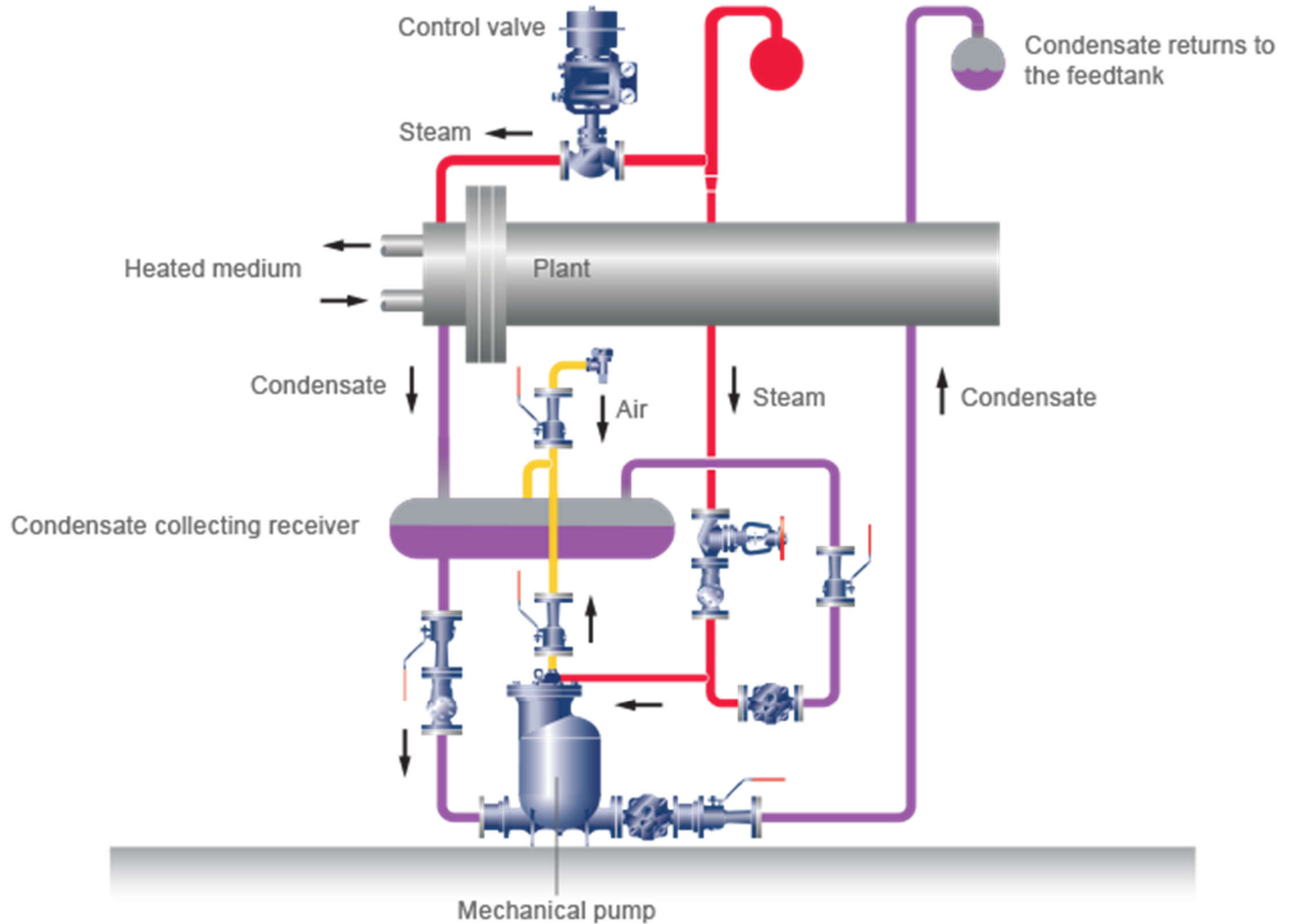

Flash steam supply and demand in step (recover flash steam energy)

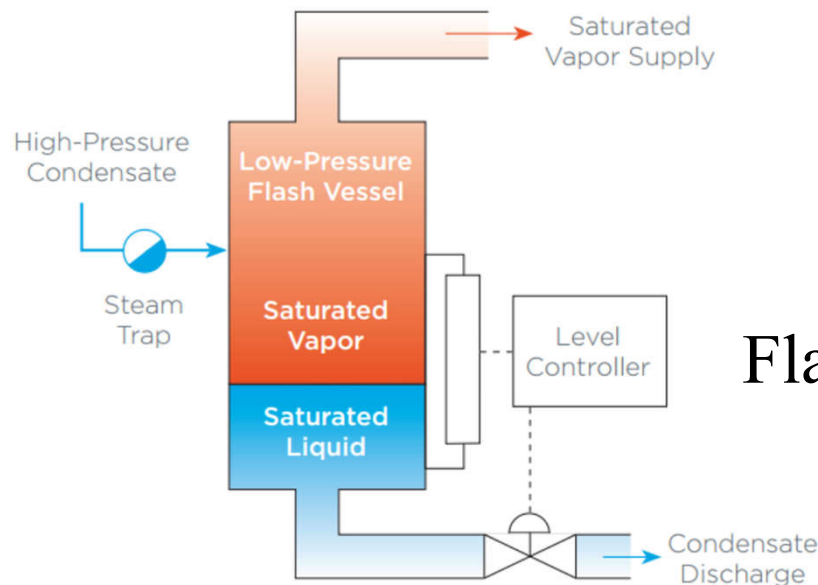
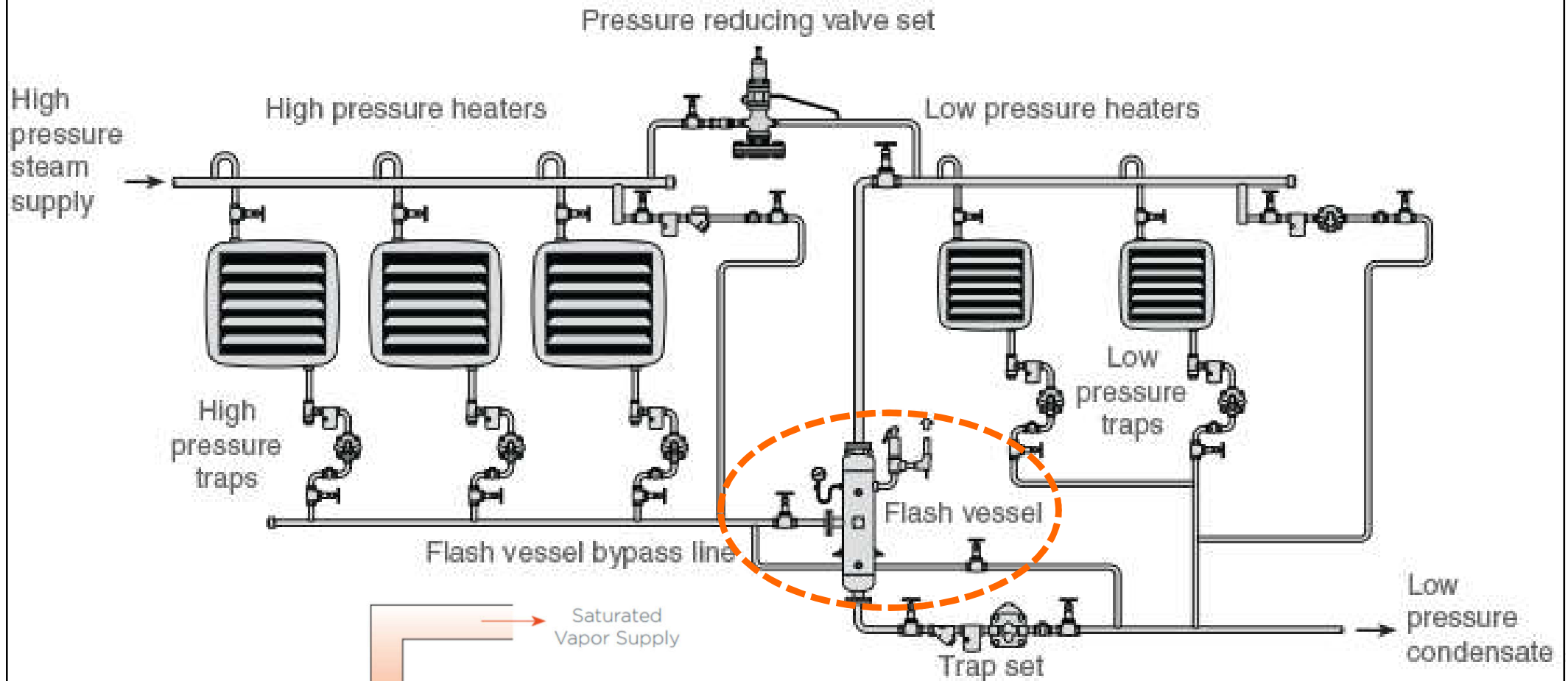

Flash steam recovery vessel

Typical heat recovery from boiler blowdown

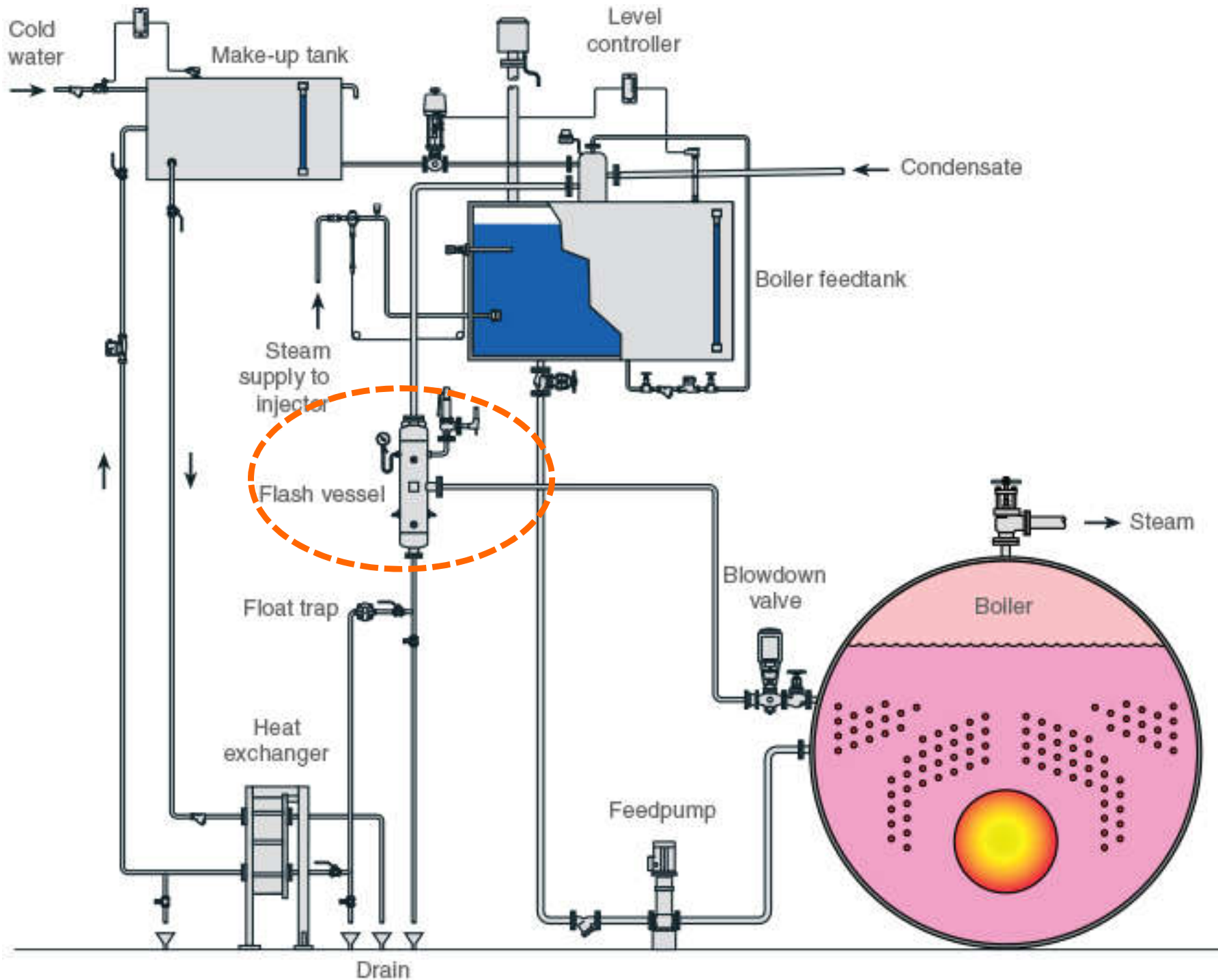



Further Reading

- Training videos:



- What Is Steam? (15:14) <https://youtu.be/T9jWTtyYLUs>
- Armstrong University Steam Basics Course (16:19) <https://youtu.be/3vr8v1EJY3c>
- Guidelines for Steam System Efficiency (15:18) <https://youtu.be/6AkTNNqwtaE>
- What is a Boiler and How does It Work? (8:55) <https://youtu.be/fk3DjD9gSsk>



Further Reading

- Learn about steam (Spirax Sarco)
 - <https://www.spiraxsarco.com/Learn-about-steam>
 - 1. Introduction
 - 2. Steam Engineering Principles and Heat Transfer
 - 3. The Boiler House
 - 10. Steam Distribution
 - 11. Steam Traps and Steam Trapping
 - 13. Condensate Removal
 - 14. Condensate Recovery
- TLV (a steam specialist company)
 - Engineering Calculator <http://www.tlv.com/global/AU/calculator/>
 - Steam Theory (Sections 1 to 11) <https://www2.tlv.com/en-au/steam-info/steam-theory>
 - Product Operation Animation <https://www2.tlv.com/en-au/products/operation>

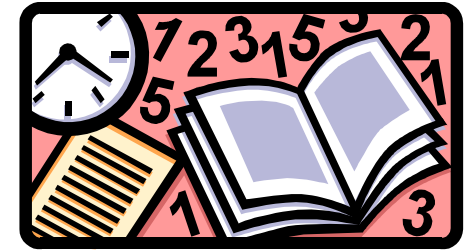

References

- CIBSE, 2015. *Design and Operation of Modern Steam Systems*, CIBSE TM58: 2015, Chartered Institution of Building Services Engineers (CIBSE), London.
- Hall F. & Greeno R., 2017. *Building Services Handbook*, 9th ed., Routledge, Oxon & New York.
- IOP, 2002. *Plumbing Engineering Services Design Guide*, [New ed.], Institute of Plumbing, Hornchurch, Essex, UK.
- McCauley, J. F., 1995. *The Steam Trap Handbook*, Fairmont Press, Lilburn, GA.
- Spirax-Sarco, 2007. *The Steam and Condensate Loop*, Spirax-Sarco, Cheltenham.