

IBTM5660 Utility Services

<http://ibse.hk/IBTM5660/>



# Telecommunication Services

*Ir Dr. Sam C. M. Hui*

E-mail: [sam.cmhui@gmail.com](mailto:sam.cmhui@gmail.com)

<http://ibse.hk/cmhui/>

Jan 2023

# Contents

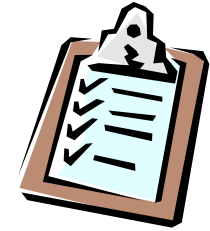

- Basic concepts
- Design issues
- Cabling management
- Networking
- Transmission methods
- In-building wireless systems

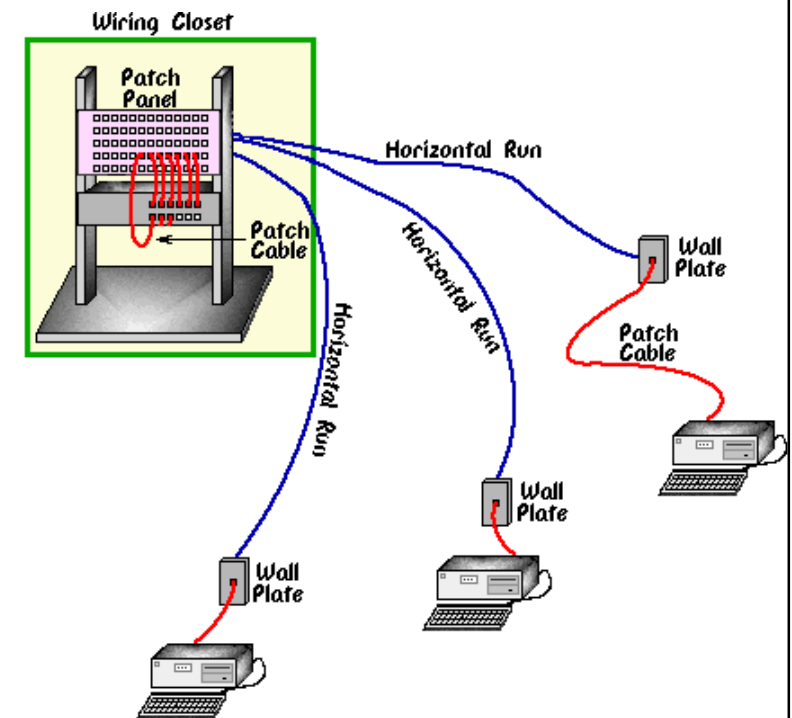



# Basic concepts

- Telecommunication 電訊
  - Communication at a distance (“Tele”)
  - Transmission, emission, or reception of signs, signals, writing, images, sounds, or information of any nature by wire, radio, optical, or other electromagnetic systems
- Telecommunication system 電訊系統
  - Uses electricity, light (visible & infrared), or radio waves to transmit signals that carry voice & data transmissions (may be analog or digital)

# Basic concept of telecommunication system

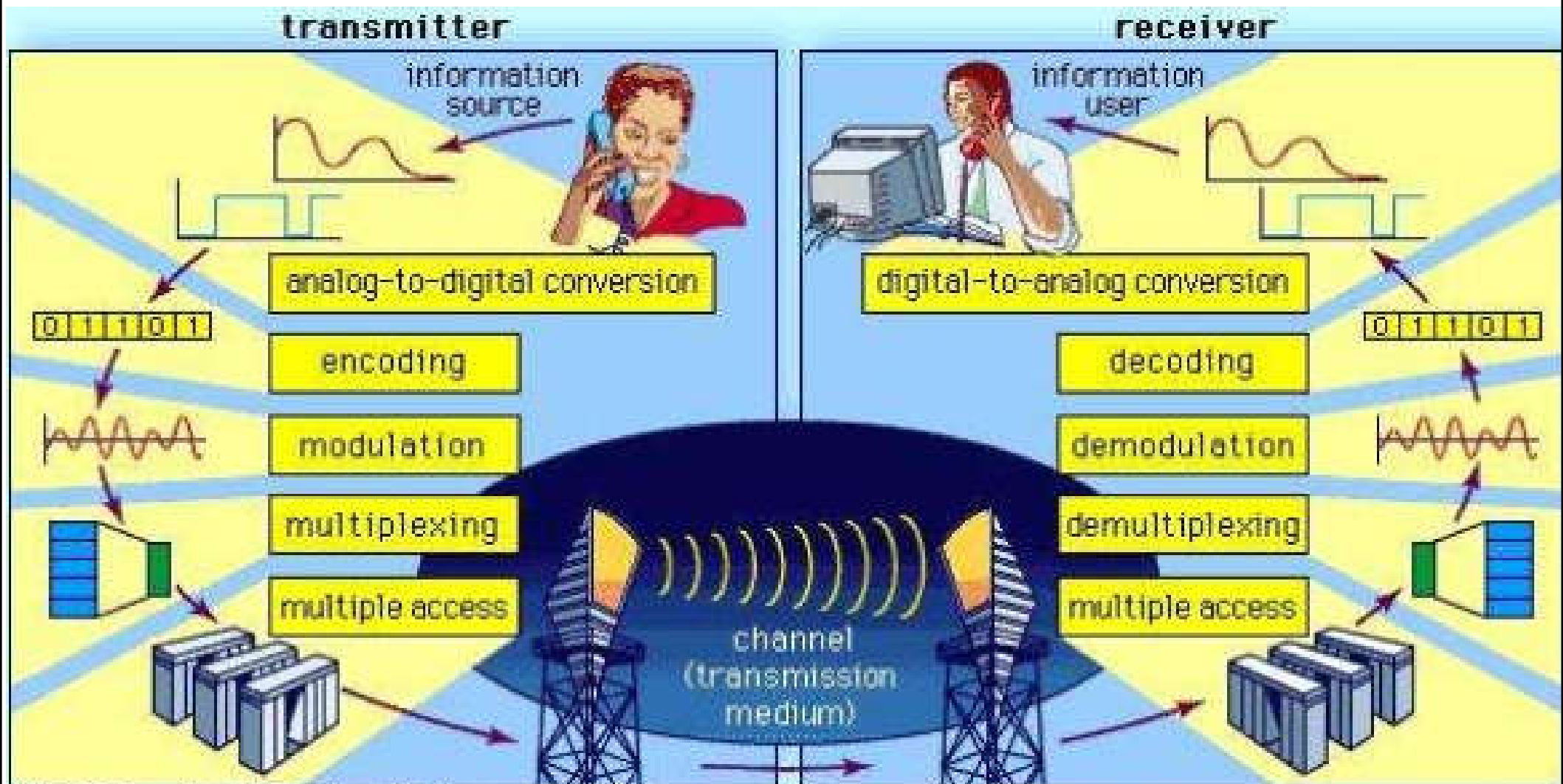

© 1999 Encyclopædia Britannica, Inc.

- “Tele” means “at a distance”
- The short form of telecommunications is “telecom”
- All telecomm systems consist sender, channel and receiver
- The data are transmitted in the form of carrier waves (analog or digital signals)

(Source: <https://www.britannica.com/technology/telecommunication>)

# Historical development of telecommunications systems & services

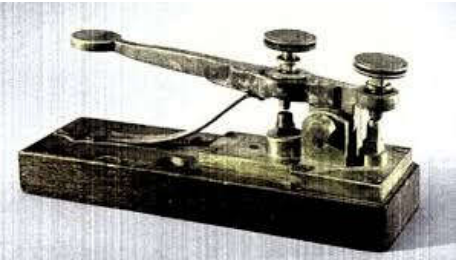

Telegraph

Wireless telegraph

Telex

Slow WAN LAN Fast WAN WLAN ADSL

Cable modems  
e-mail  
Internet WWW

Telephone

Telefax

Cordless telephones  
ISDN  
Telefax Gr 4

AM radio FM radio Stereo radio Digital radio

Radio Telephone TV Color TV Stereo TV Digital TV VoD

Cellular Telephone  
Paging  
Digital Cellular Telephone  
Mobile Data  
Mobile IP



Abbreviations:

- WAN = Wide Area Network
- LAN = Local Area Network
- WLAN = Wireless LAN
- WWW = World Wide Web
- ADSL = Asymmetrical Digital Subscriber Line
- ISDN = Integrated Services Digital Network
- AM = Amplitude Modulation
- FM = Frequency Modulation
- IP = Internet Protocol
- CS = Circuit Switched
- PS = Packet Switched
- VoD = Video on Demand

1850 1930 1970 1990 2000 2005 Time/year

(Source: Anttalainen T., 2003. *Introduction to Telecommunications Network Engineering*, Second Edition, Artech House, Boston & London.)

# Basic concepts



- Telecommunication network 電訊網絡
  - A collection of communication equipment & devices that are interconnected so they can communicate in order to share data, hardware, and software or perform an electronic function
  - The network includes a series of connecting points called nodes (e.g. a terminal like a telephone receiver or computer) that are interconnected with cables (wiring)

# Communications supply arrangement

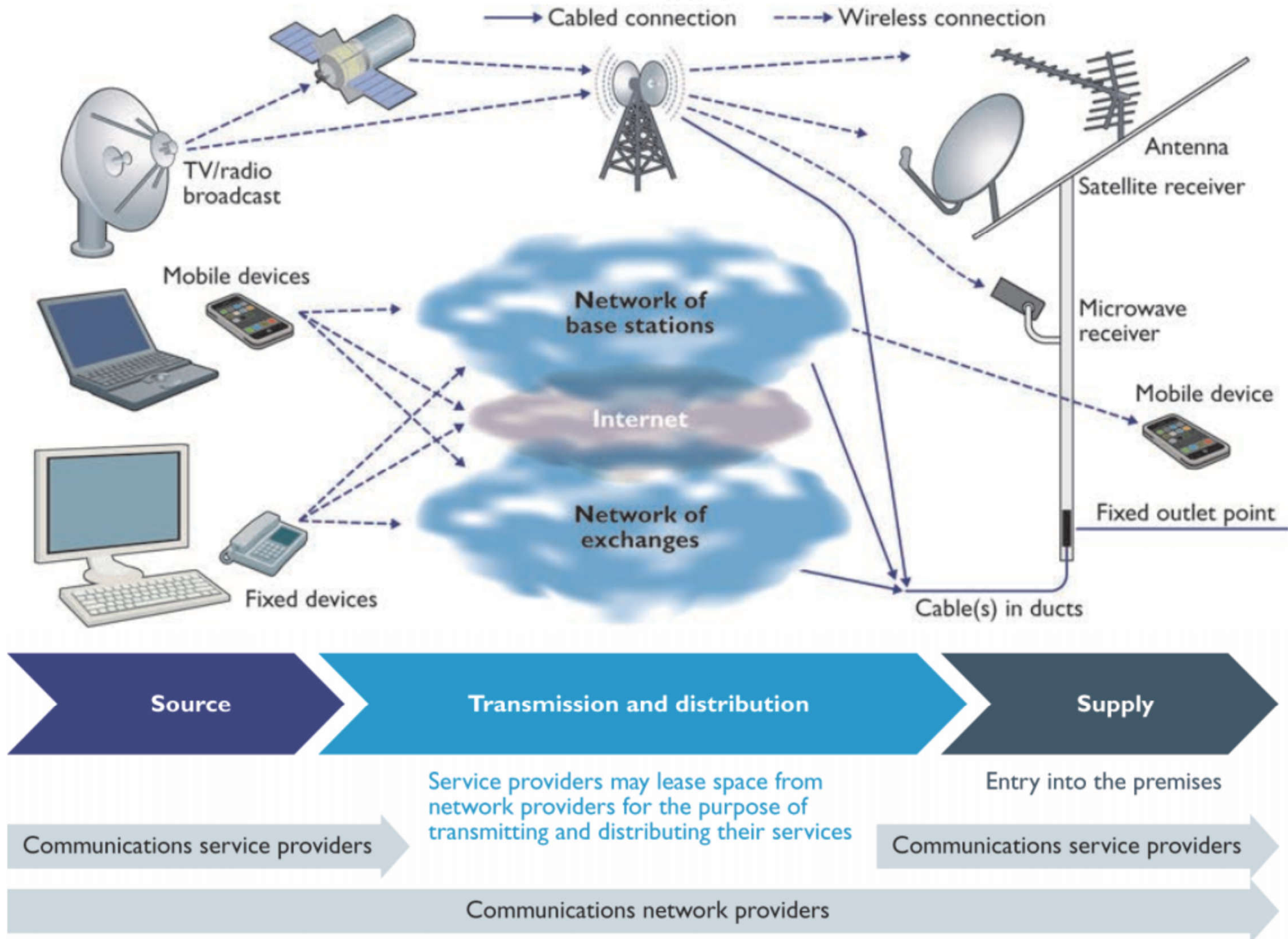

(Source: Portman J. & Bleicher D., 2011. *Utility Connections and Diversions: Planning, design and installation*, BG 37/2011.)



# Basic concepts

- Telecommunications & information technology (IT)
  - Influence people & many aspects of our life
  - Affect building design & requirements
  - Require the setting up of information systems
- Information systems
  - 1. User (voice, text, image & data networks)
  - 2. Building (bldg. mgt., energy, fire, security)
  - 3. Miscellaneous (public address, CCTV, etc.)



# User Information Technology

Voice and data networking  
PABX and telephones  
Information feeds  
External communications links  
Paging and messaging  
Video distribution  
Public address  
Electronic signage  
Access, movement control & security  
Energy management system  
Building automation system

# Building Information Systems

More  
user  
oriented

More  
building  
oriented

# Examples of IT & telecommunication systems in a building

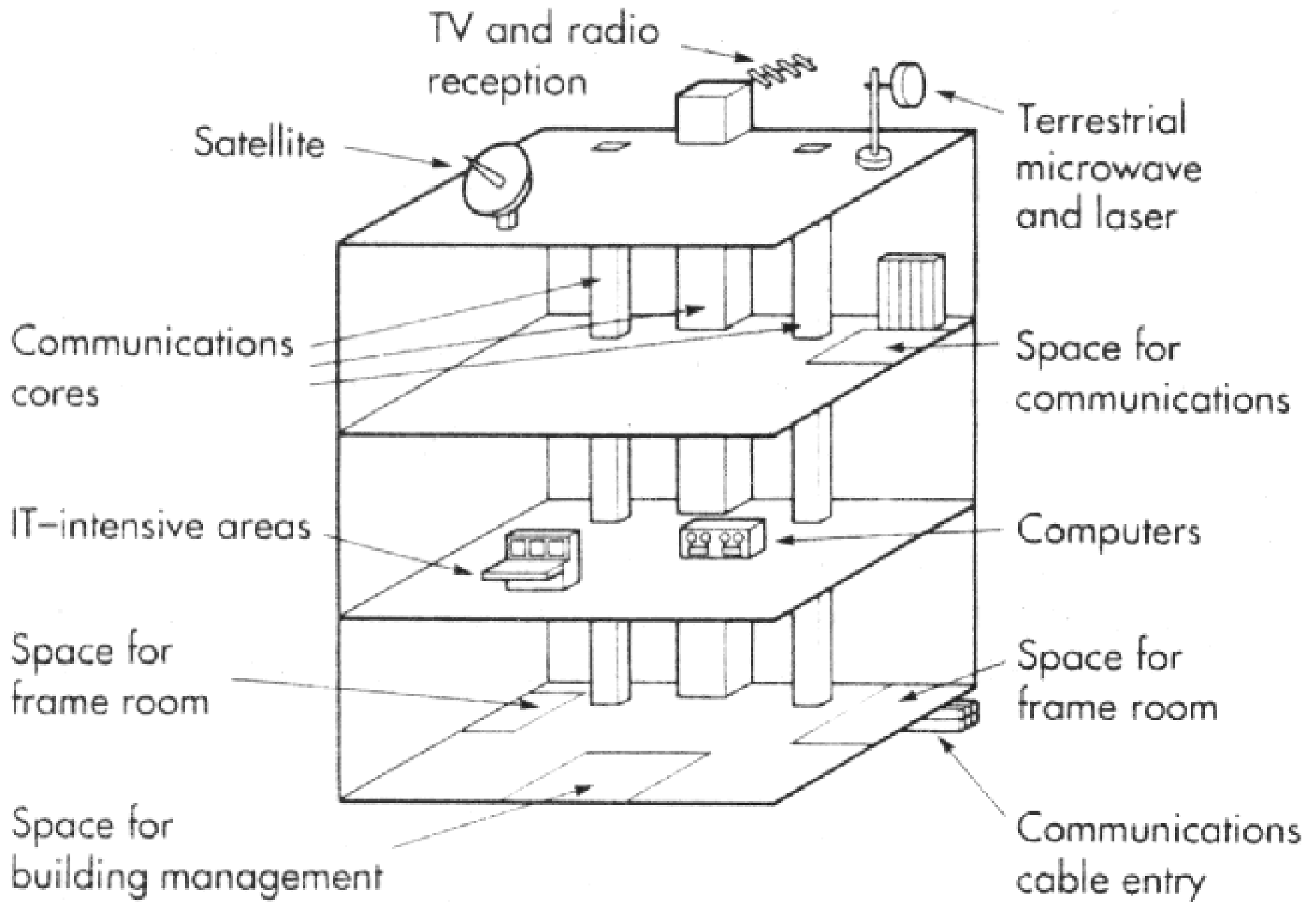

(Source: CIBSE, 1992. Information Technology and Buildings)



# Basic concepts

- Information Technology (IT) in buildings
  - Systems of structured cable & wireless information technologies relating to buildings & building occupants
    - Building systems -- HVAC, lighting, daylighting control, energy monitoring, security access, and fire/smoke detection and alarm
    - Telecommunications -- voice, data, graphics, and audio/video
  - Properly designed pathways & spaces are needed to accommodate the IT systems



# Basic concepts

- The density & demand of IT equipment in buildings increase many times
  - A robust and secure infrastructure is needed to support the growing & evolving demands of business & organisations (e.g. server rooms)
- Key factors for buildings to accommodate IT
  - Space requirements (for equipment & distribution)
  - Power requirements (electricity supply)
  - Environmental requirements (e.g. temperature)



# Basic concepts

- Major considerations
  - Flexibility
  - Accessibility
  - Life cycle
  - Cost-benefit
- Flexibility
  - Building & IT infrastructure design must be flexible & adaptable to accommodate future new technologies (e.g. by scalable IT infrastructure)

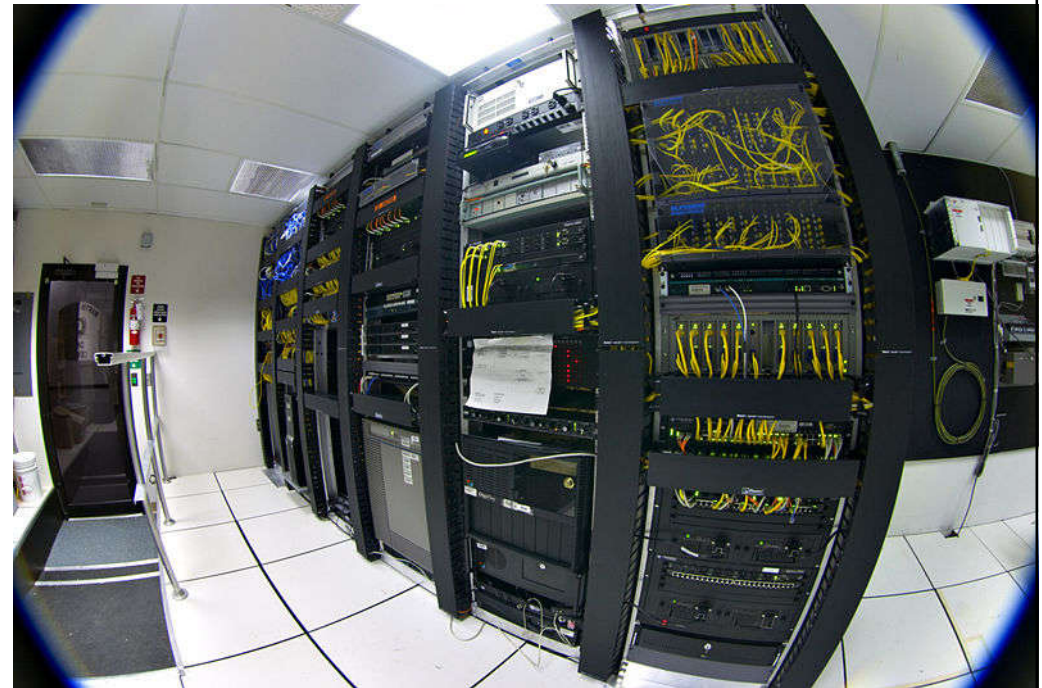



# Basic concepts

- Design for IT flexibility should consider:
  - Adequate power for future building/system expansion
  - Adaptable power & telecommunication cores, adaptable dedicated electrical & telecommunications spaces
  - HVAC delivery to dedicated IT spaces
  - Network security (vulnerabilities & reliability)
  - Strategically located branch takeoffs & utility stubs
  - Adaptable plenum systems -- either overhead or underfloor, coordinated with space needs for building services systems
  - Overhead exposed cable trays integrated with building services systems (HVAC, power, lighting, fire protection)



# Basic concepts

- IT systems take up space, e.g.
  - In basements where cables enter, on desks, in risers, above ceilings, under carpets, in special equipment areas, on roofs and in car parks
- Life cycle considerations
  - The frames of buildings have lives of many decades during which the IT systems contained will be updated & replaced several times
  - With proper planning, it is not necessary to provide new cabling every time systems are changed or upgraded (cost savings)

Life  
Cycle  
Diagram

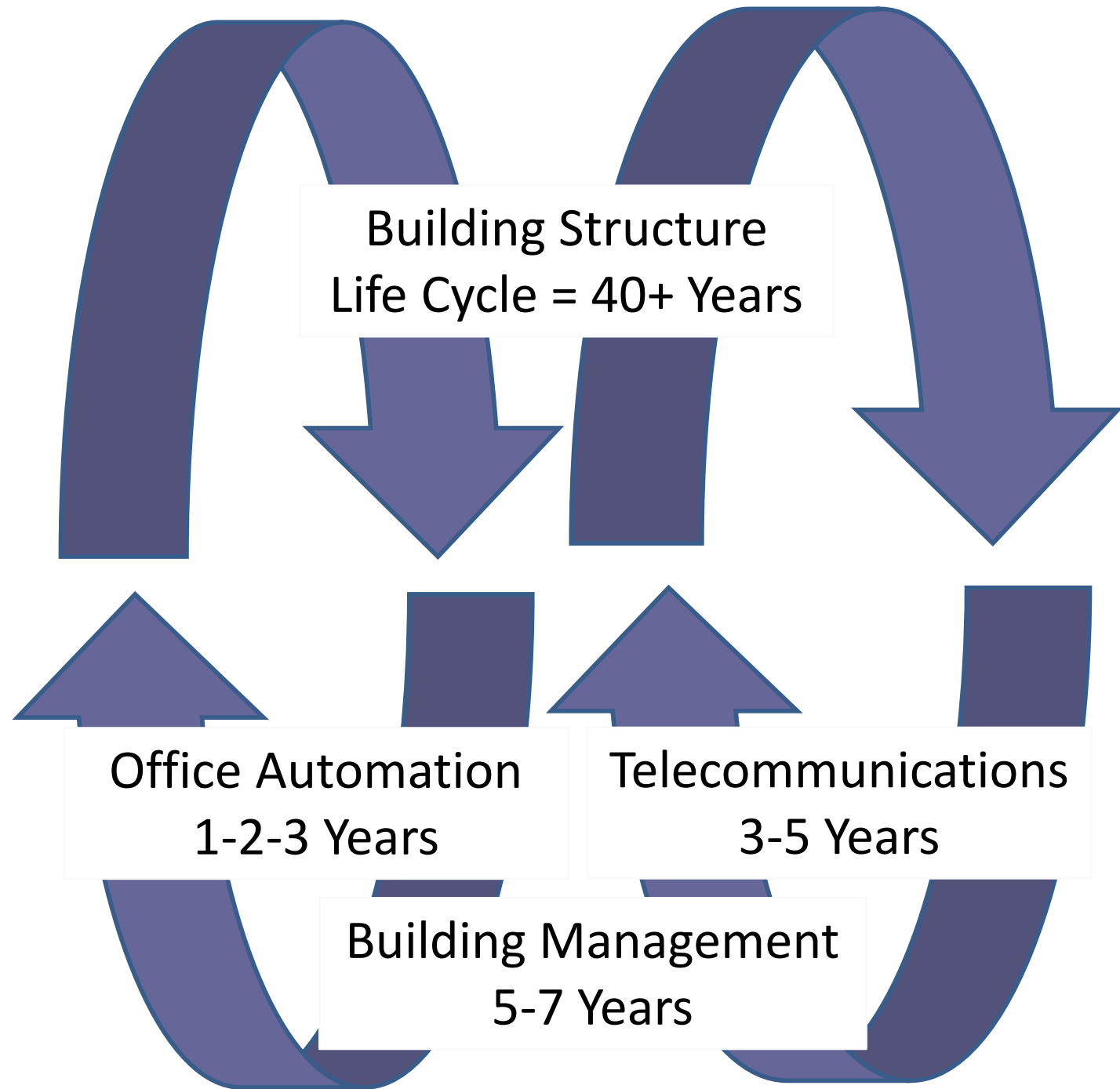





# Basic concepts

- Planning for IT (a dynamic process)
  - Consider carefully its own “information needs”
    - Present & anticipated use of information
    - Standard of service: speed of transfer, availability, error rates & user-friendliness
    - Corporate view of the rate of IT introduction
    - Geographical distribution of IT
    - Likely growth of, and ‘churn’ within, the organisation
    - Existing & proposed use of building stock
    - Assessment of the suitability of building stock for IT



# Basic concepts

- Example: Planning and designing your IT Infrastructure
  - Part I: Networking
    - <https://synyx.de/blog/planning-and-designing-your-it-infrastructure-part-i-networking/>
      - Networking hardware and your needs
      - LAN, WAN or CAN infrastructure
      - Network applications and bandwidth
      - Number of users and networked devices
      - Office layout, hardware & software components
      - Budget for the installation and maintenance



# Basic concepts

- Example: Planning and designing your IT Infrastructure (cont'd)
  - Part II: Evaluating your requirements and designing your data center
    - <https://synyx.de/blog/planning-and-designing-your-it-infrastructure-part-ii-evaluating-your-requirements-and-designing-your-data-center/>
      - Evaluate what you want and what you really need
      - Don't overbuild; Don't plan for now, plan for the future!
      - Cost of Ownership (vs. webhosting, cloud solutions)
      - Select a proper data center site



# Basic concepts

- Following planning, the subsequent phases are important for implementing the IT:
  - 1. Design & procurement of systems and cabling
  - 2. Installation, testing & commissioning
  - 3. Operation, management, maintenance & modification
  - 4. Removal & recovery of redundant systems
- Critical for buildings with high IT demands
  - Such as data centres, high-tech offices



# Basic concepts

- Emerging issues
  - Integrated building design practice
    - Use the same cable network for different systems
  - Interoperability across all systems
    - Among user IT and building operating systems
  - Building Information Modeling (BIM)
    - A master, intelligent data model to design & manage
  - Wireless communication technologies
  - Smart & intelligent buildings

# Infrastructure and systems for “intelligent building”

Infrastructure		
Sensors, Structured cabling, IP network, Wireless*, Plant rooms, Data rooms, Server rooms, Communications rooms, etc.		
Building systems (ICS) <sup>†</sup>	ICT systems <sup>†</sup>	Business systems <sup>‡</sup>
Building management HVAC controls Access control Lighting control Intruder alarm Security/CCTV Fire alarm Water management Waste management Utilities Stand-by generators UPS	Office automation (email, data, Internet)  Media/multi-media (voice, video, music)  Telephony (voice, fax, video conferencing, SMS, pagers)  IP-based applications <sup>§</sup>	Enterprise resource planning (ERP) Material requirements planning (MRP) Customer relationship management (CRM) Integrated command-and- control centre Integrated service/ helpdesks

\* The term ‘wireless’ is used as a generic term to cover communications and data links that do not require a physical connection; technologies employed include WiFi, Bluetooth, ZigBee, radio, NFC, RFID

† ICS – Industrial Control Systems; ICT = information and communication technology

‡ Only included to the extent that they are integrated with building systems, for example CRM – Access Control, ERP/MRP – Supply Chain Management

§ Relevant where they interact with building systems or sensors, for example RFID for tracking location of material or assets



# Basic concepts

- Internet Protocol (IP) Telephony

- Use of IP-based networks to build, provide and access voice, data or other forms of telephonic communications

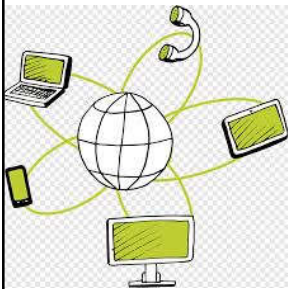

- Replace the telecommunications' infrastructure of circuit switched public data networks (CSPDN) and public switched telephone networks (PSTN) with packet switched IP communication networks
- Voice over IP (VoIP) is a popular implementation which only supports voice communication over IP

# Internet Protocol (IP) Telephony and Voice over IP (VoIP)

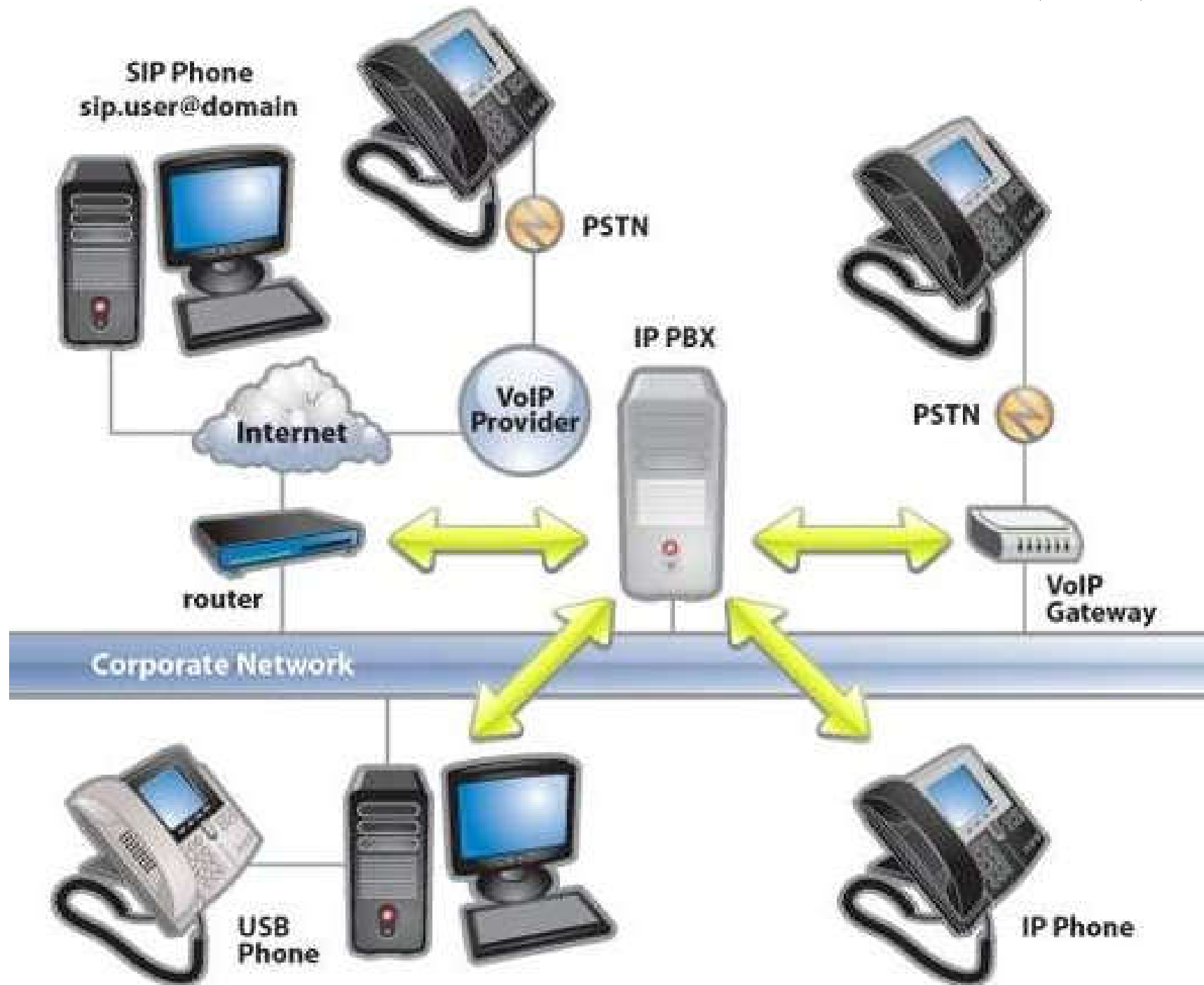





# Design issues

---

- Design requirements
  - Plant & equipment rooms, spaces & pathways
  - Electrical power, bonding & earthing/grounding
  - Environmental requirements (e.g. cooling)
  - Fire safety issues
- Typical telecommunication room facilities
  - Room lighting, air conditioning, fire protection
  - Temperature sensor, raised floor, AC power supply, station earthing, working tables & chairs

# Telecommunication spaces

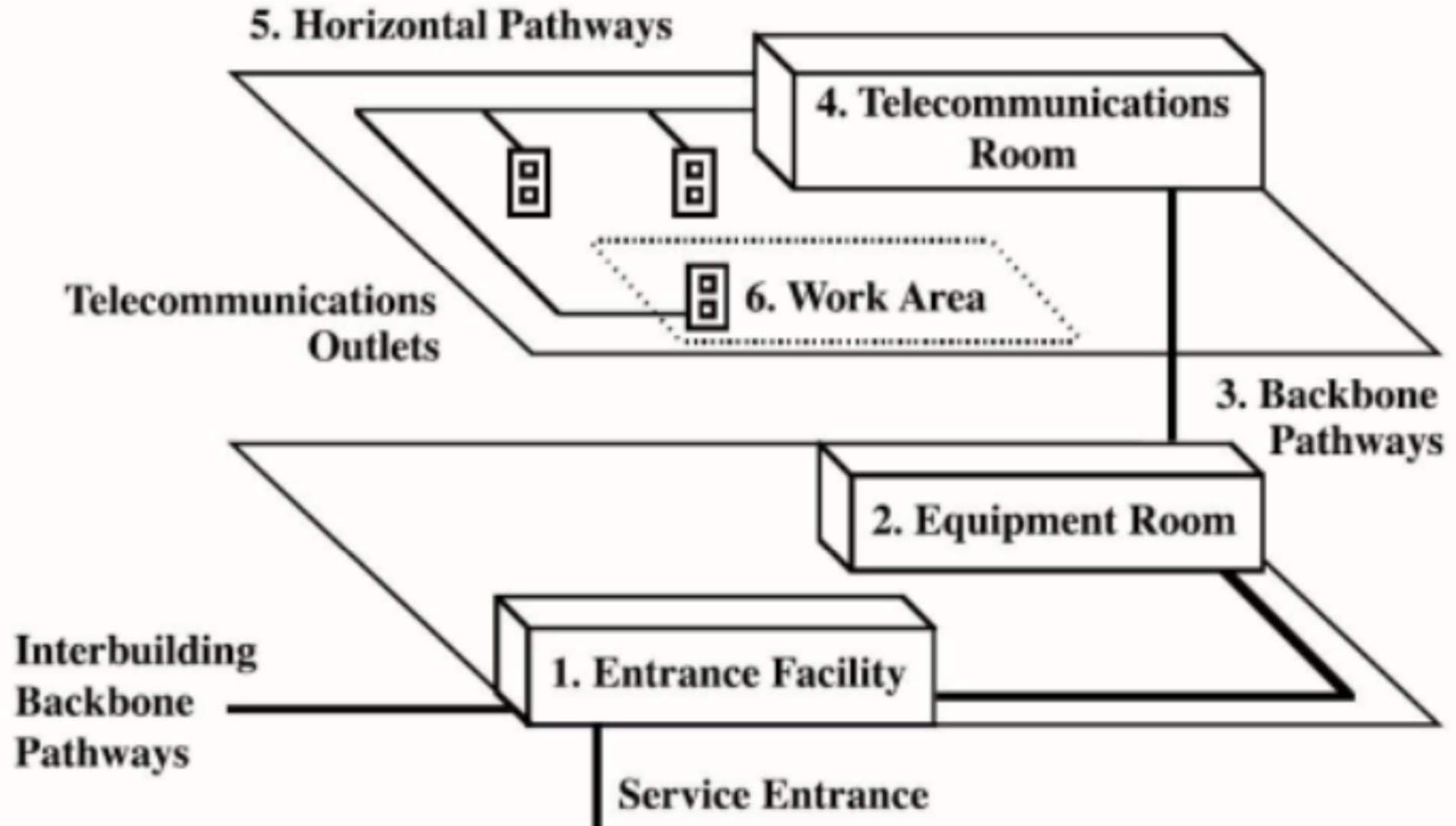

- 1. Building Entrance Facility
- 2. Equipment Rooms
- 3. Backbone Pathways

- 4. Telecommunication Rooms
- 5. Horizontal Pathways
- 6. Work Areas

# Telecommunications spaces and pathways

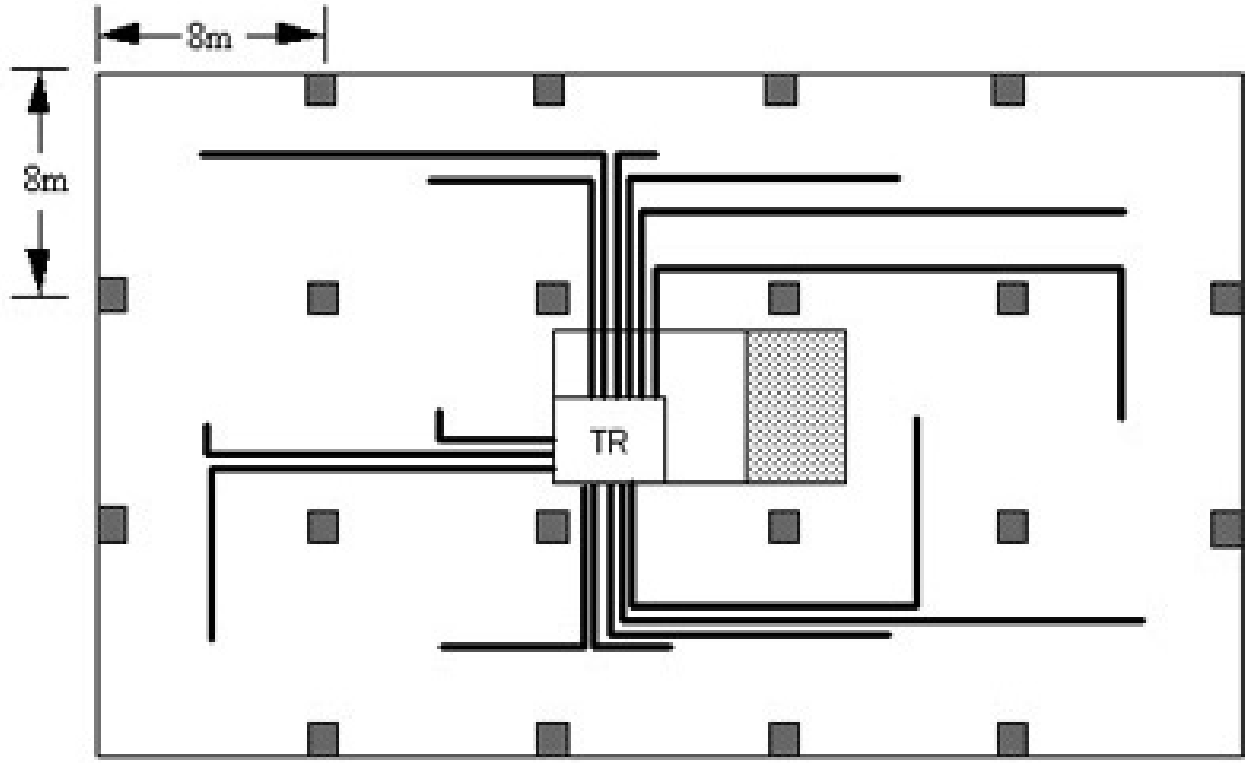
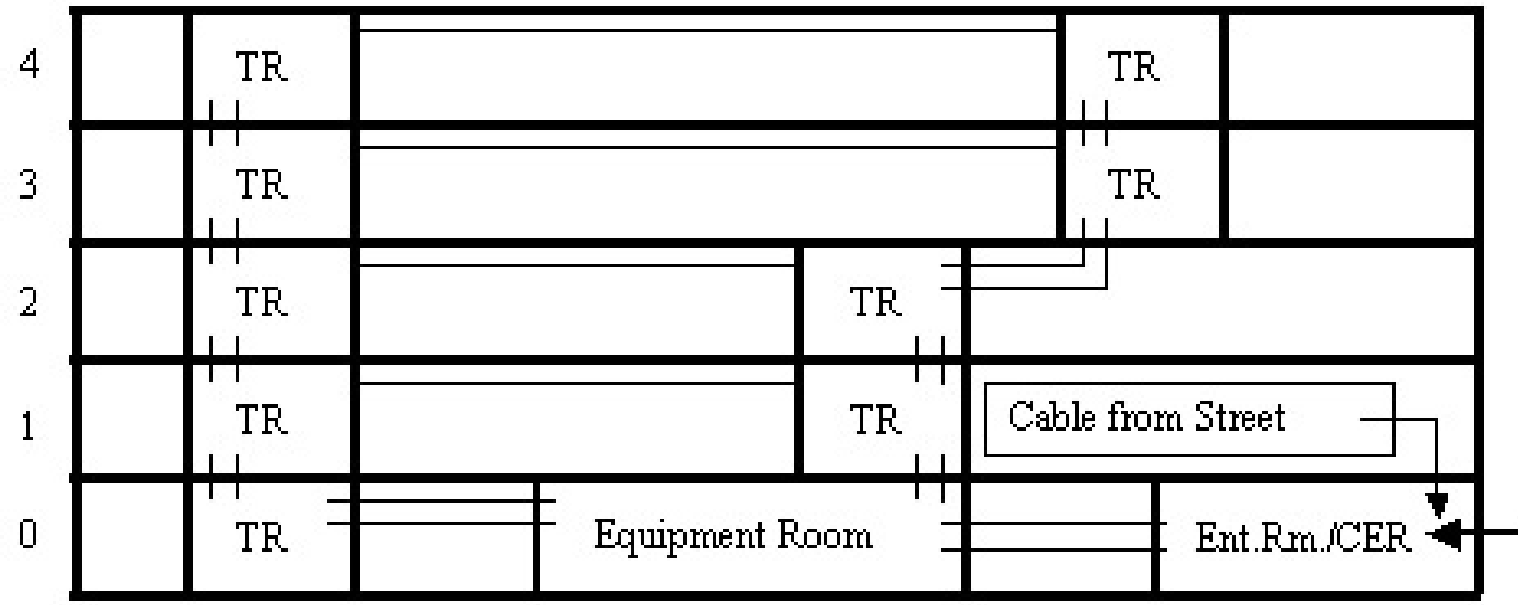

TR = telecommunications room  
 Ent. Rm./CER = Entrance Room/Common Equipment Room

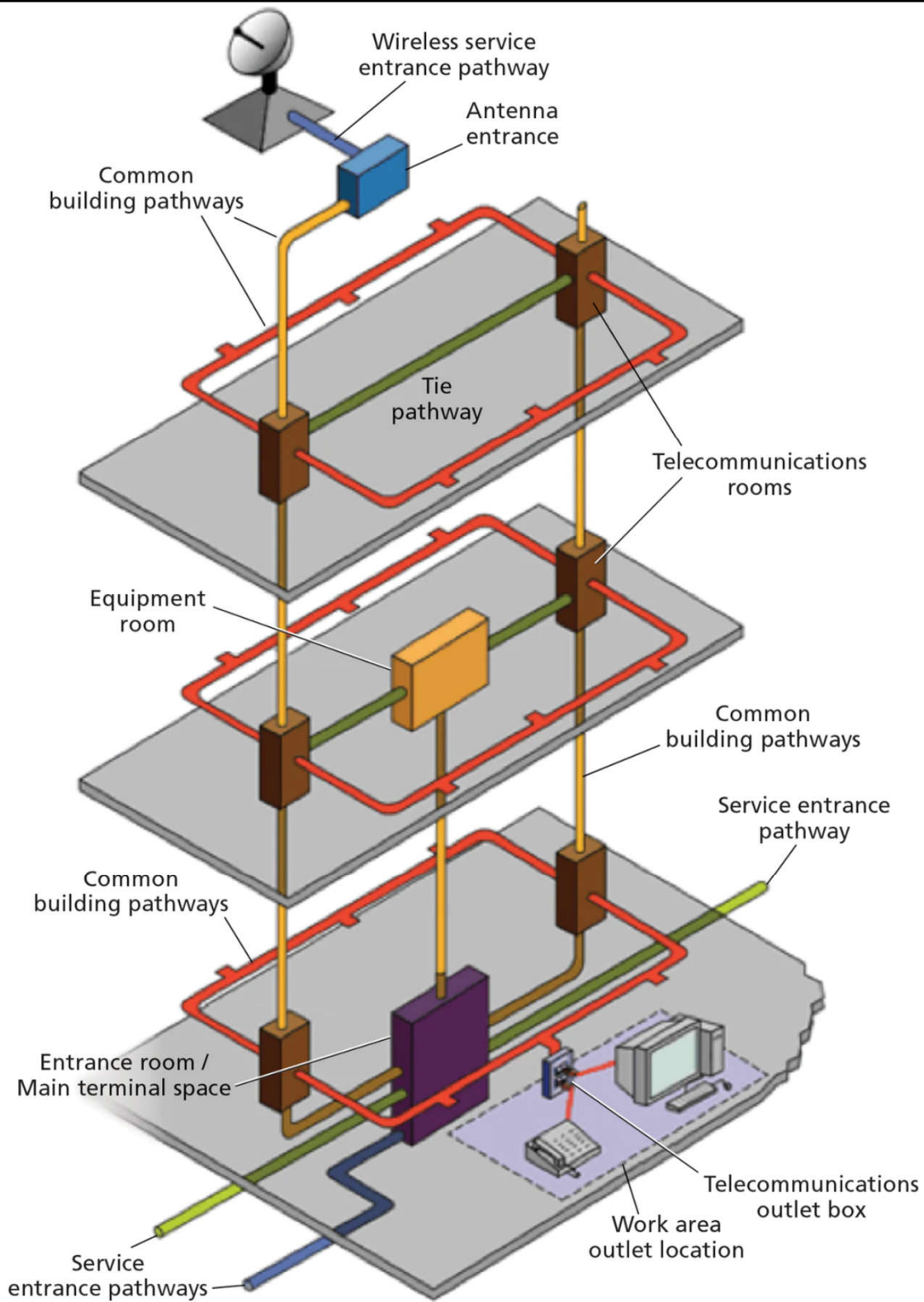

## Vertical & horizontal distribution for telecommunication networks

(Source: <https://www.cablinginstall.com/design-install/cabling-installation/article/14036591/corning-cabling-futureready-commercial-office-buildings>)

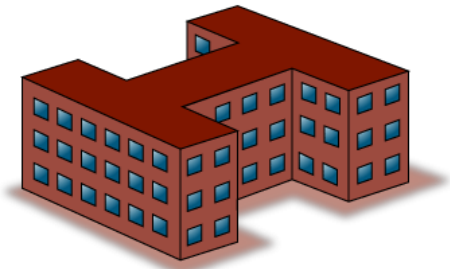

# Design issues

- Structural requirements
  - Integration of architecture, building services & structural engineering
- Vertical cable distribution
  - Designated cable ducts or riser space
- Horizontal distribution
  - Raised access floor if IT usage is high
  - Typical heights for zoning (Zone 1 to 7)
    - Steel frame
    - Concrete frame

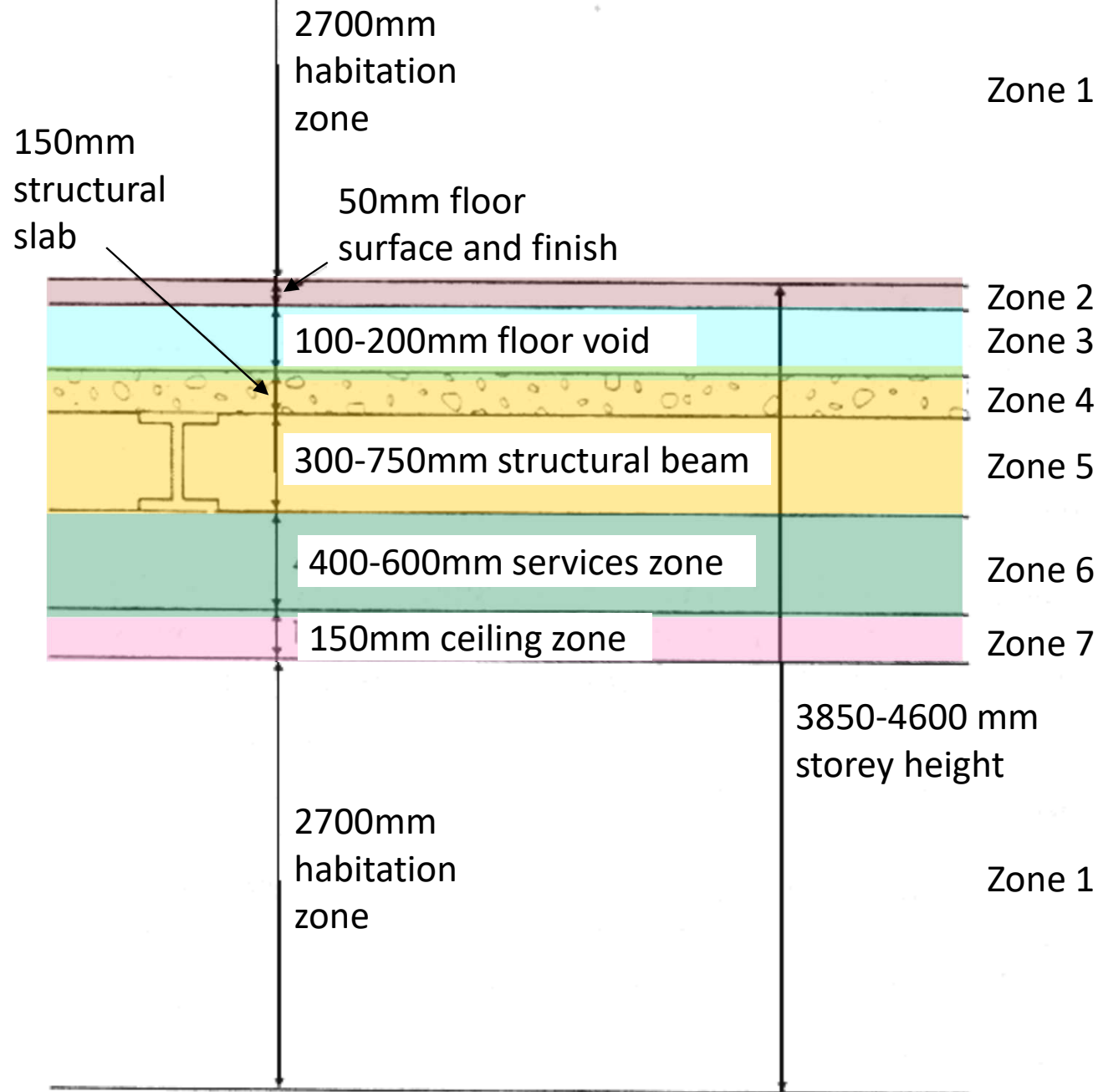

Steel frame  
(3.85-4.6m  
storey height)

(Source: CIBSE, 1992. Information Technology and Buildings)

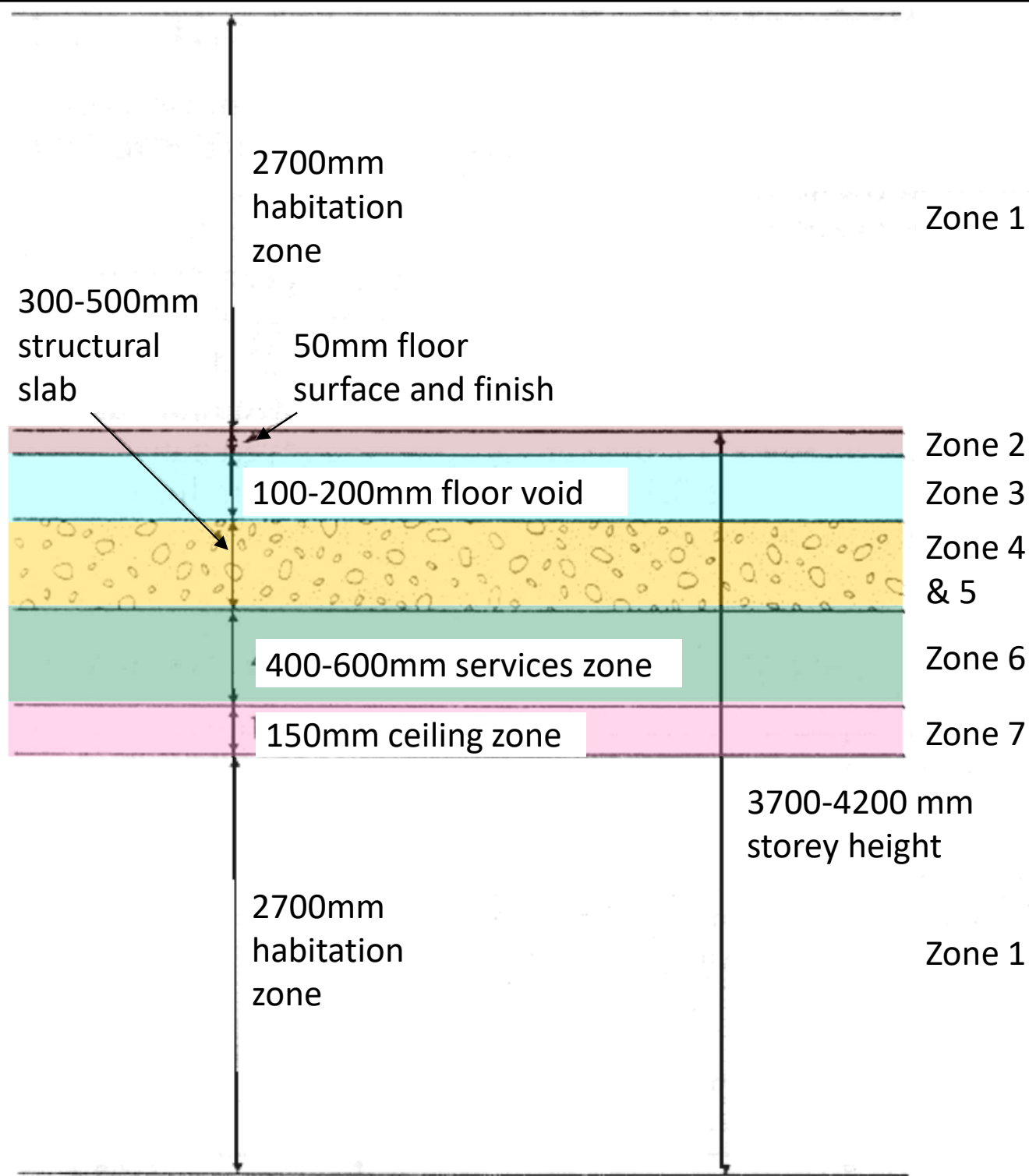

Re-inforced  
concrete  
frame  
(3.7-4.2m  
storey height)

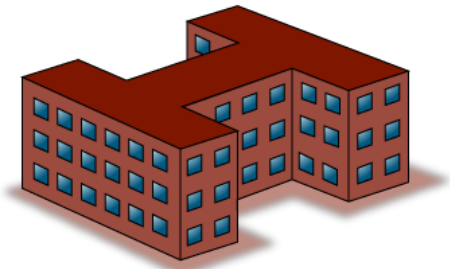

# Design issues

- Floor loading

- Usually IT equipment will not exceed the floor loads, except where equipment densities are high
- Where point loads are high, load spreading must be used, such as for power equipment
- High volume of papers (very heavy!)
- Loads of raised floors
- Access areas
- Weight of power or radio equipment on roofs



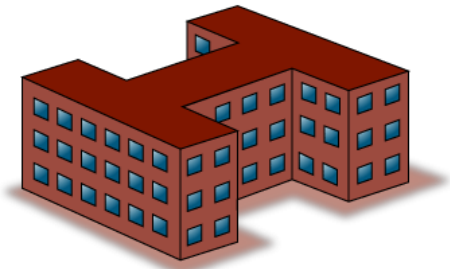

# Design issues

- IT equipment rooms

- Project planning

- Detailed knowledge of IT equipment often not known
- May consult the public telephone/network operators & equipment suppliers

- Design considerations

- Voice and data services
- Distributed equipment rooms
- Components of IT systems



# Components of IT systems

<b>System</b>	<b>External service</b>	<b>Equipment</b>	<b>Internal distribution</b>
Telephone	Telephone lines	PABX	Extension wiring Network links
Central computer	Network links	CPU	Terminal wiring
Departmental computer	Network links	CPU	Terminal wiring plus network
Local area network	Gateway or data link	Distributed processing	Internal wiring Bridge links
Information system	Network link to service	Controller wiring	Display terminal provider

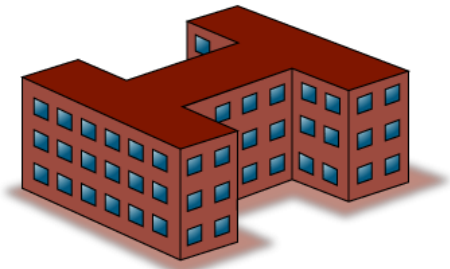

# Design issues

- General equipment rooms: design considerations
  - Minimum room height, floor void, ceiling void
  - Sufficient floor loadings
  - Access for installing, operating and maintenance of equipment
  - Environment suitable for operating the equipment
  - Room finishes easily cleaned
  - Floor areas allowed for all equipment, staff, services, storage, etc

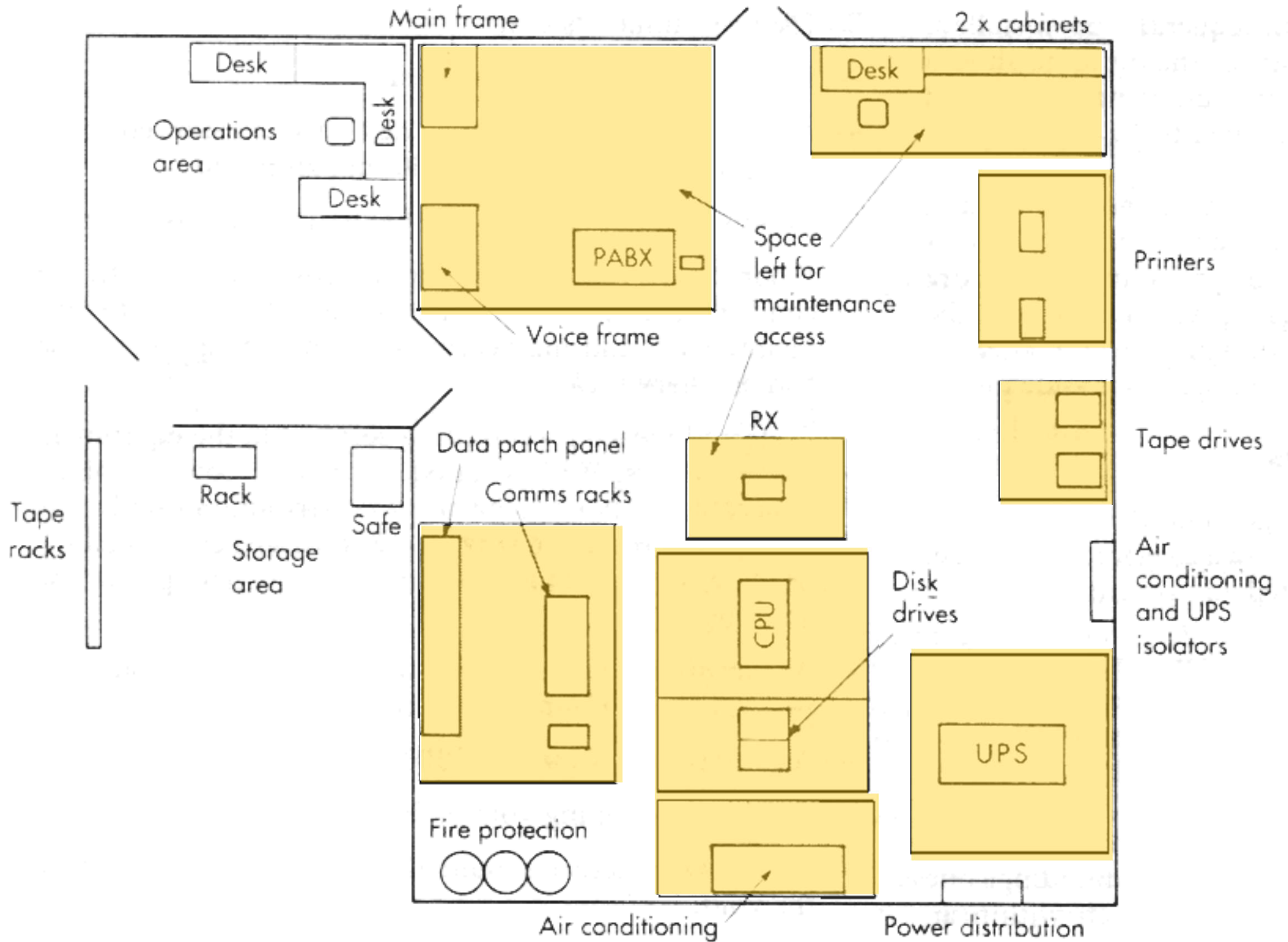

(Source: CIBSE, 1992. Information Technology and Buildings)

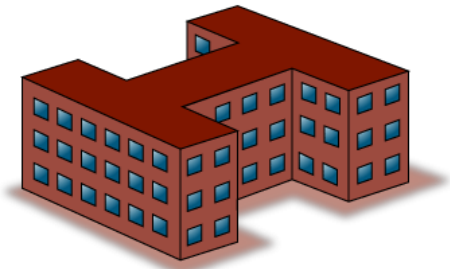

# Design issues

- General equipment rooms: design considerations (cont'd)
  - Future expansion allowance
  - Access for equipment deliveries
  - Preferred methods of locating services
    - Within raised floor void: power cabling, data cabling, HVAC pipework, air distribution supply, fire detection/protection services
    - Within suspended ceiling: lighting, air distribution return, fire detection/protection services

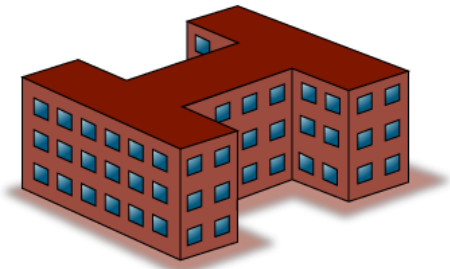

# Design issues

- Major sub-systems:
  - Lead-in or entrance facilities, including cable entry and cable entry chamber
  - Telecommunications and broadcasting equipment (TBE) room [*Equipment room*]
  - Secondary TBE room [*Telecomm room*]
  - Vertical riser (backbone)
  - Horizontal distribution facilities

# Design issues

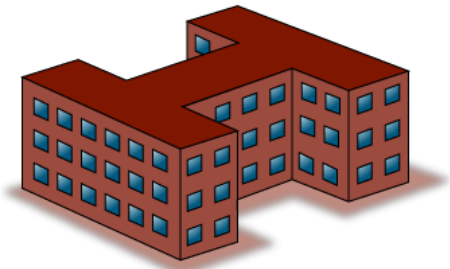

- Major sub-systems: (cont'd)
  - Telecommunications closets
  - Accommodation for subscription TV receiving system
  - TV/FM outlets
  - Telephone sockets
  - Cables
  - Rooftops (antennas)

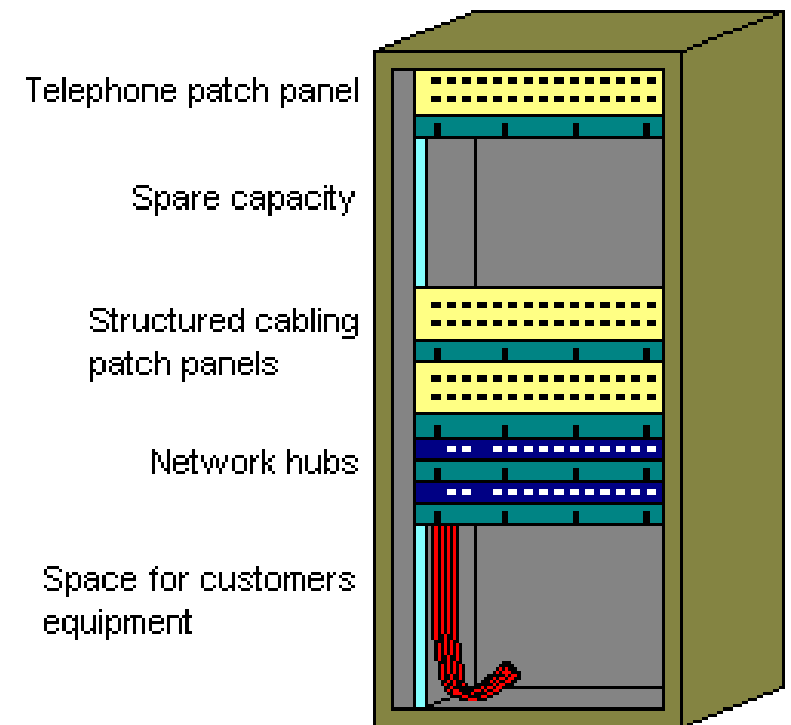

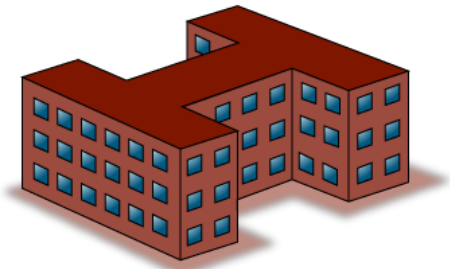

# Design issues

- Space planning
  - IT fit-out: equipment is known
  - “Speculative” building: equipment not known
  - Electrical closets & communication closets
  - Minimum areas for equipment
    - Consult telecom operators or follow standards
- Hong Kong telecommunication services:
  - Communication Authority (CA) 通訊事務管理局  
<https://www.coms-auth.hk/>
  - Codes of Practice/Guidelines [https://www.coms-auth.hk/en/policies\\_regulations/cop\\_guidelines/telecomm/](https://www.coms-auth.hk/en/policies_regulations/cop_guidelines/telecomm/)



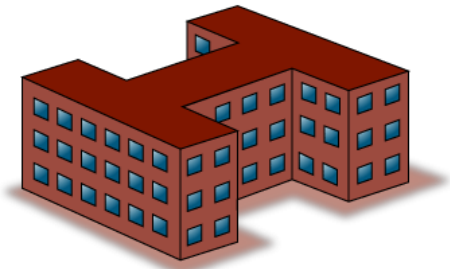

# Design issues

- Entry points and equipment rooms
  - Entry points for cables & services
    - Multiple routing to reduce risk of disruption
  - Radio systems (e.g. antenna mounting)
  - Frame rooms (may also houses the PABX)
- Maintenance access
  - Areas for maintenance and safety
    - Consult telephone operators & suppliers
  - Access
    - Clearly separate groups, compartments or rooms
    - Used by operating staff and maintenance staff

# Typical telecom cabling system

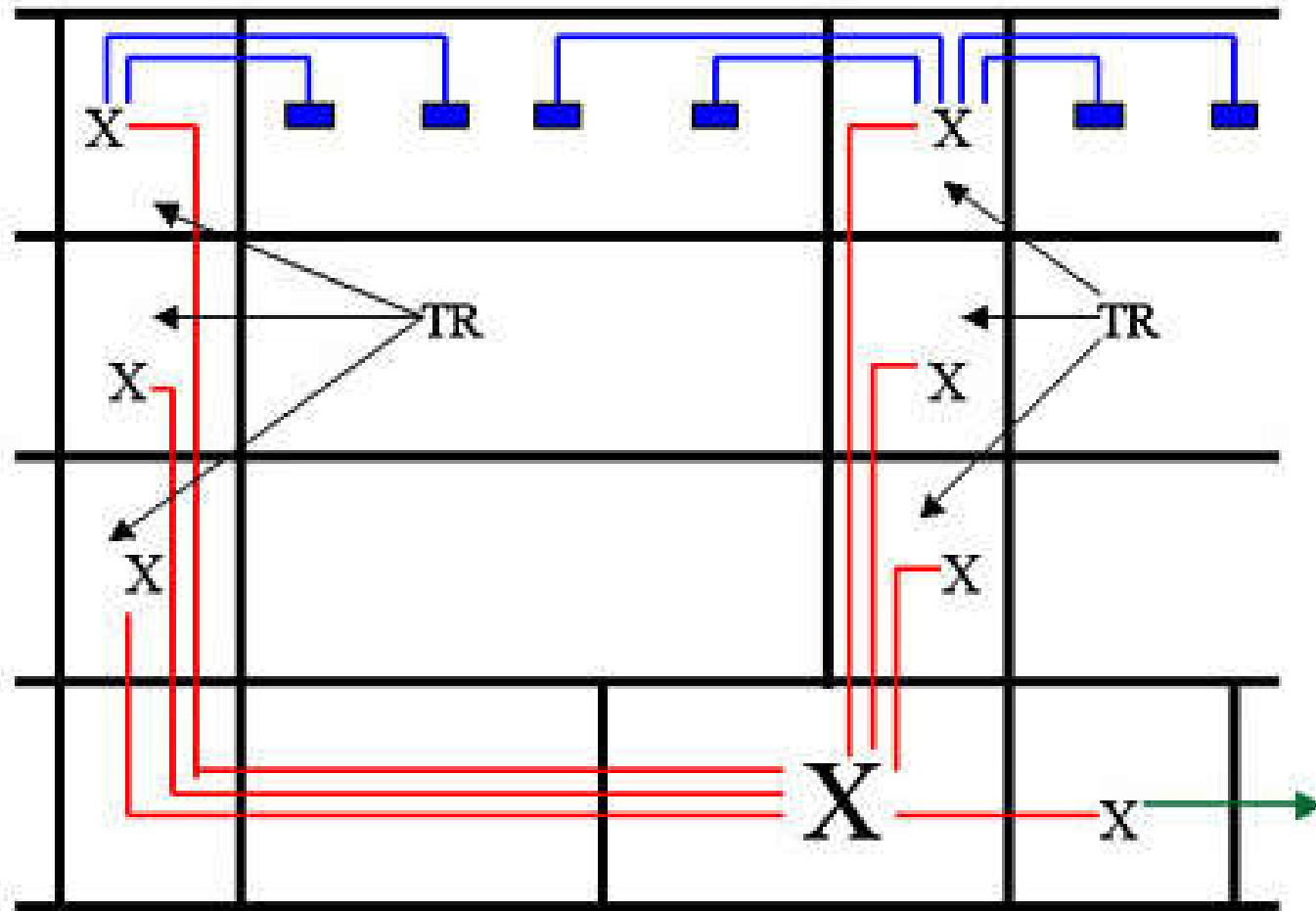

MT/ER

ER

 Horizontal Cables

TR: Telecommunications Room

 Backbone Cables

MT/ER: Main Terminal / Equipment Room

 Carrier cables from Street

ER: Entrance Room

**X** Cross-connect

 Work-area jacks (voice, data)

# Multi-tenant building: legacy approach and holistic approach

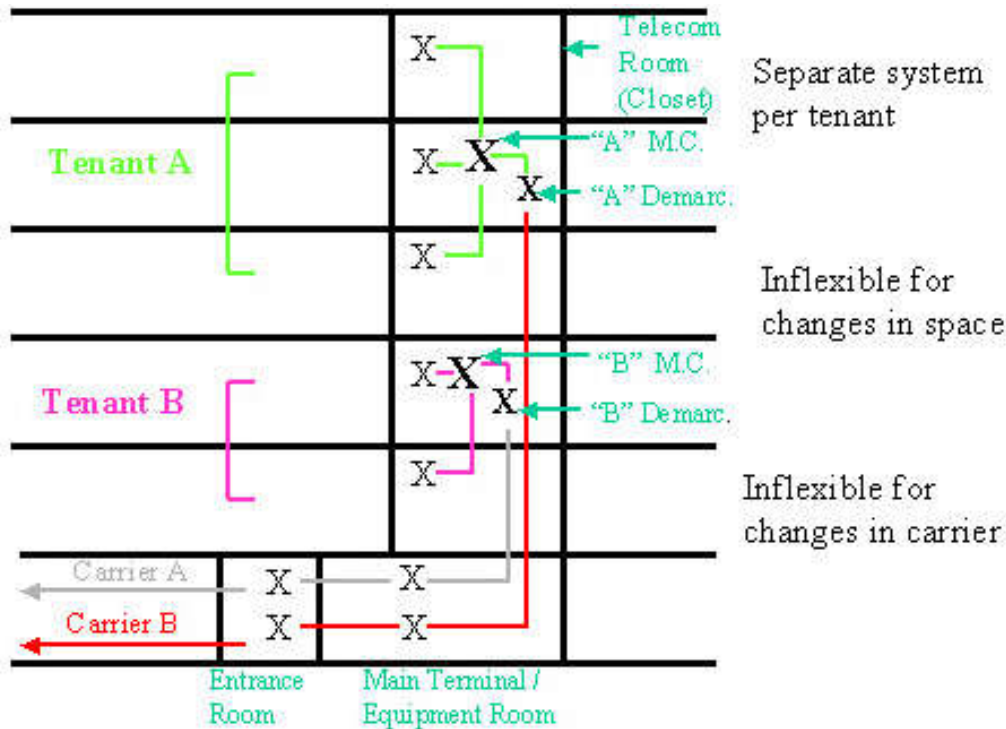

(a) Legacy approach

Each tenant creates its own main cross-connect, installs pathways & backbone cables connecting each of the floor telecom room, and establishes a point of demarcation with the facilities of the telecom carriers.

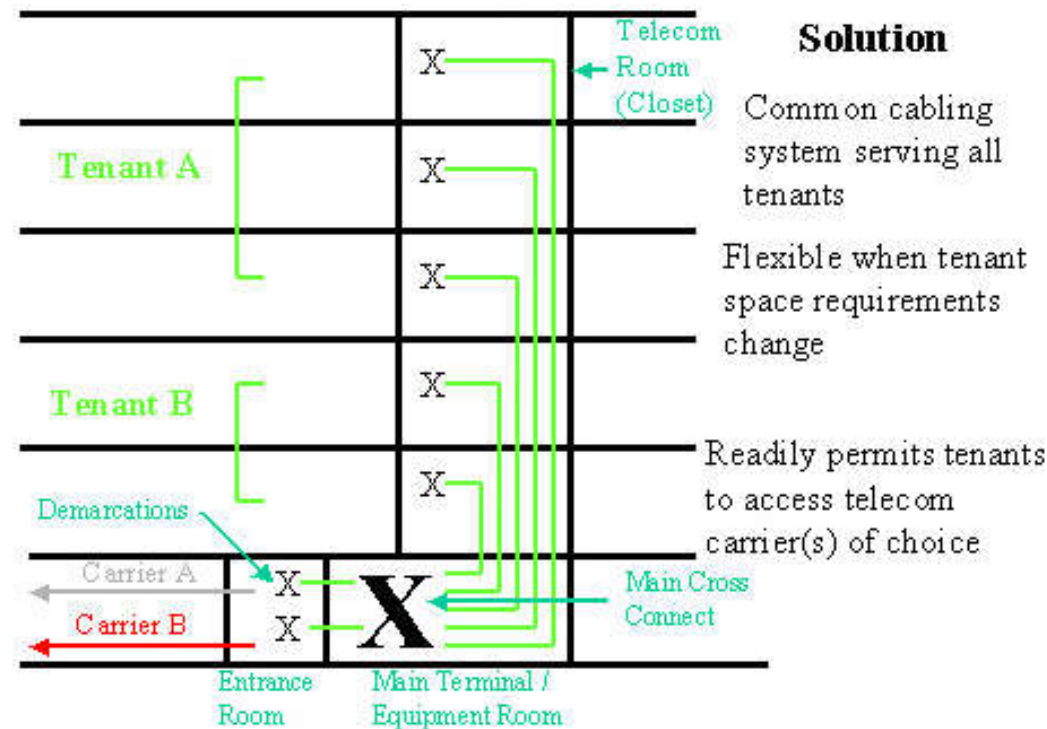

(b) Holistic approach

Adapts to changes in space allocations between tenants or the addition of new tenants. It accommodates fluctuations between single and multiple occupancy of the building & readily permits tenants to select their telecomm common carriers.

# Example of a basic data centre topology

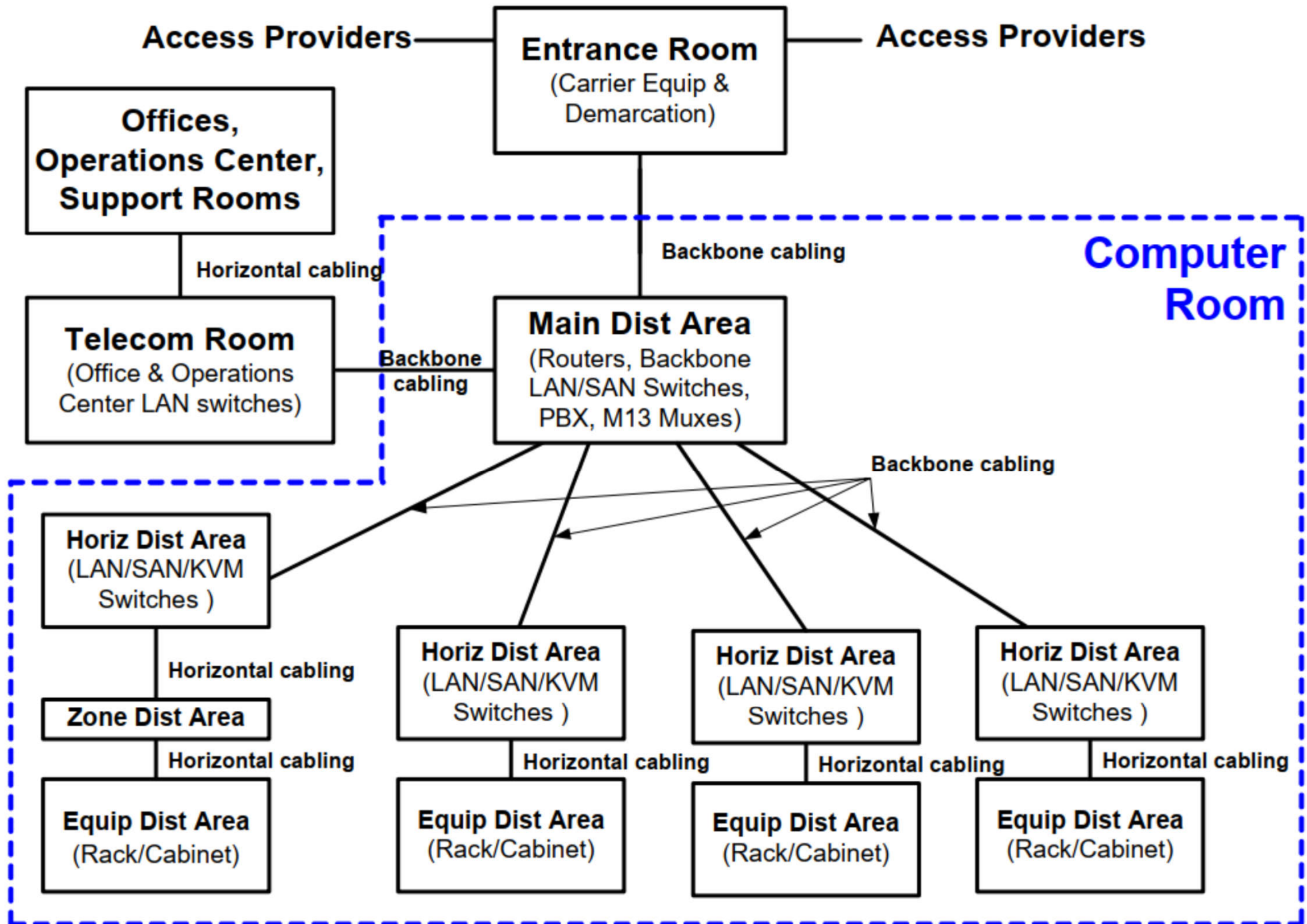

# Cabling management



結構化佈線系統

- Structured cabling system (SCS)
  - A set of cabling and connectivity products that integrates the voice, data, video, and various management systems of a building (e.g. safety alarms, security access, energy systems, etc.)
    - Give saturation wiring & flexibility
    - Radial architecture connection (back to closet)
    - Suitable patching to facilitate maintenance
  - Once the main components of the system is installed, it do not change

# Cabling management



- Industry standards to address the cabling and cable-delivery methods (pathways & spaces)
  - Such as EIA/TIA 568, ISO/IEC 11801
  - Based on a structured subsystem architecture
- 4 key components of structured cabling
  - Telecommunication outlets
  - Horizontal cabling
  - Patch panels and floor distributors (data hub)
  - Backbone cable

# Structured cabling network diagram

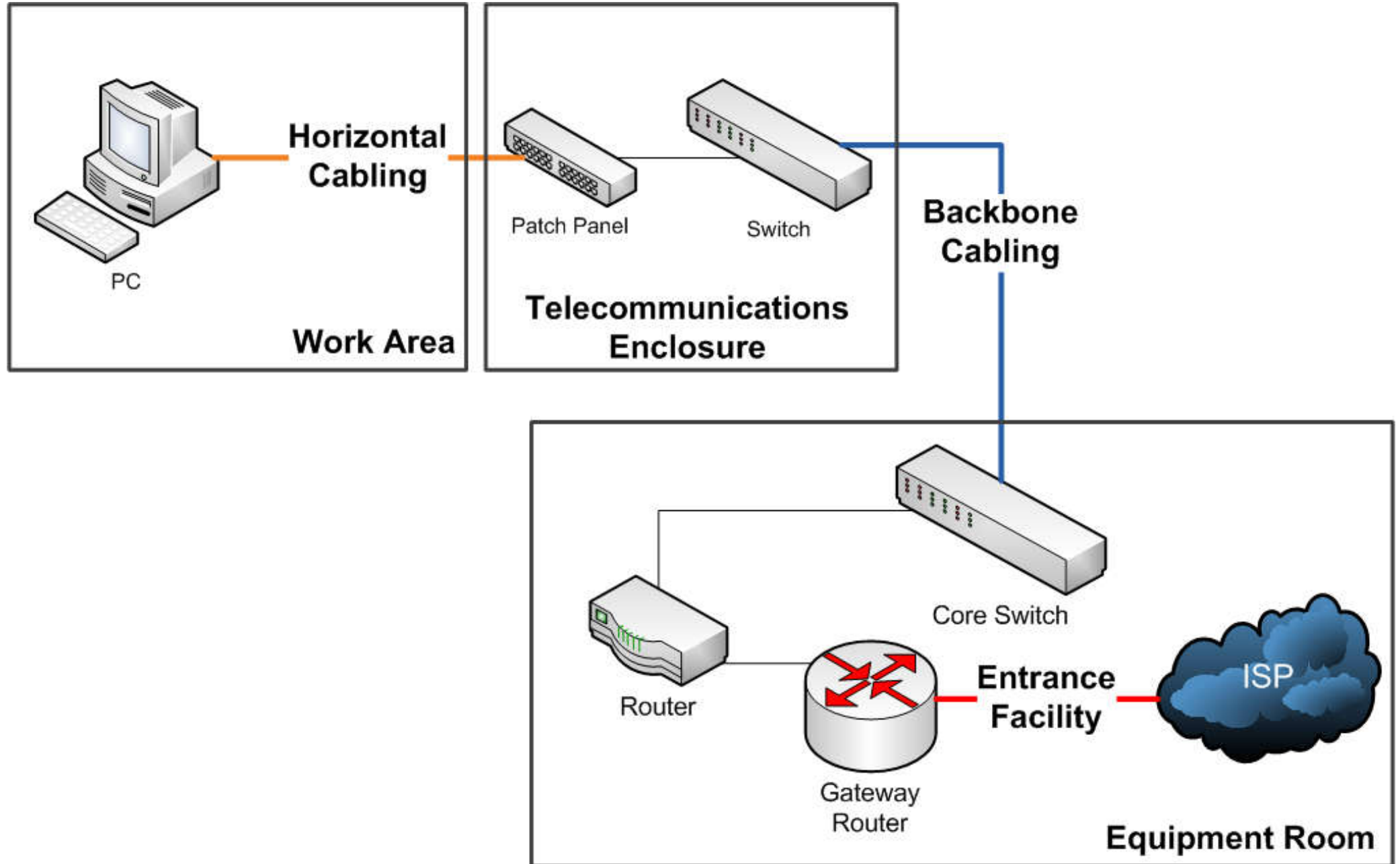

# Basic layout of a structured cabling installation

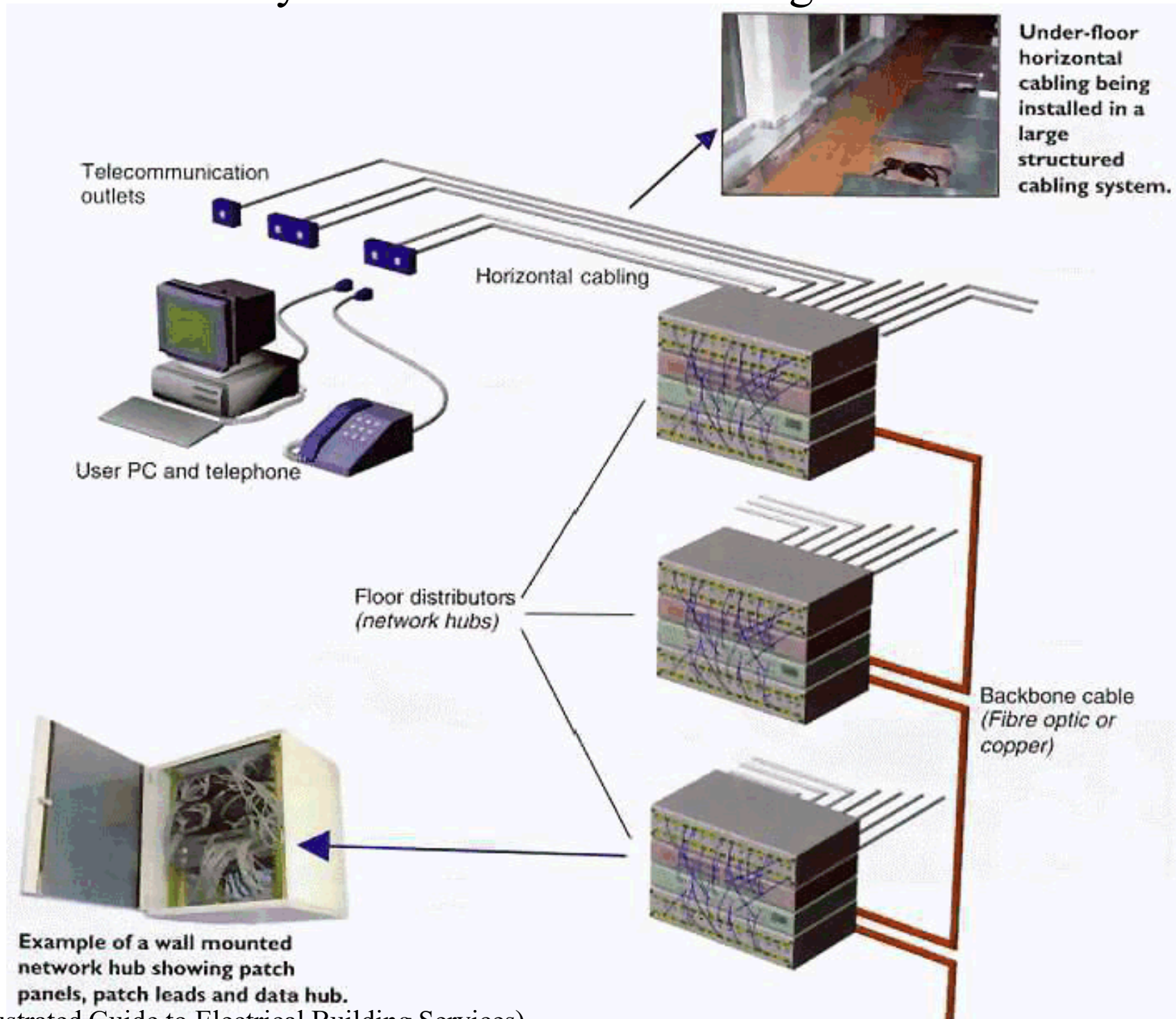

(Source: Illustrated Guide to Electrical Building Services)



TC = telecomm closet

# Structured Cabling Subsystems

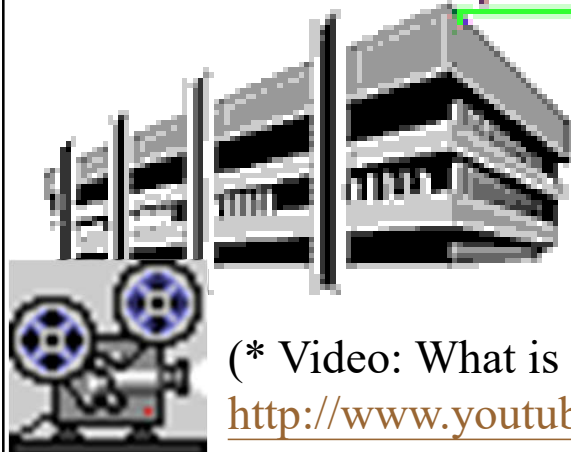
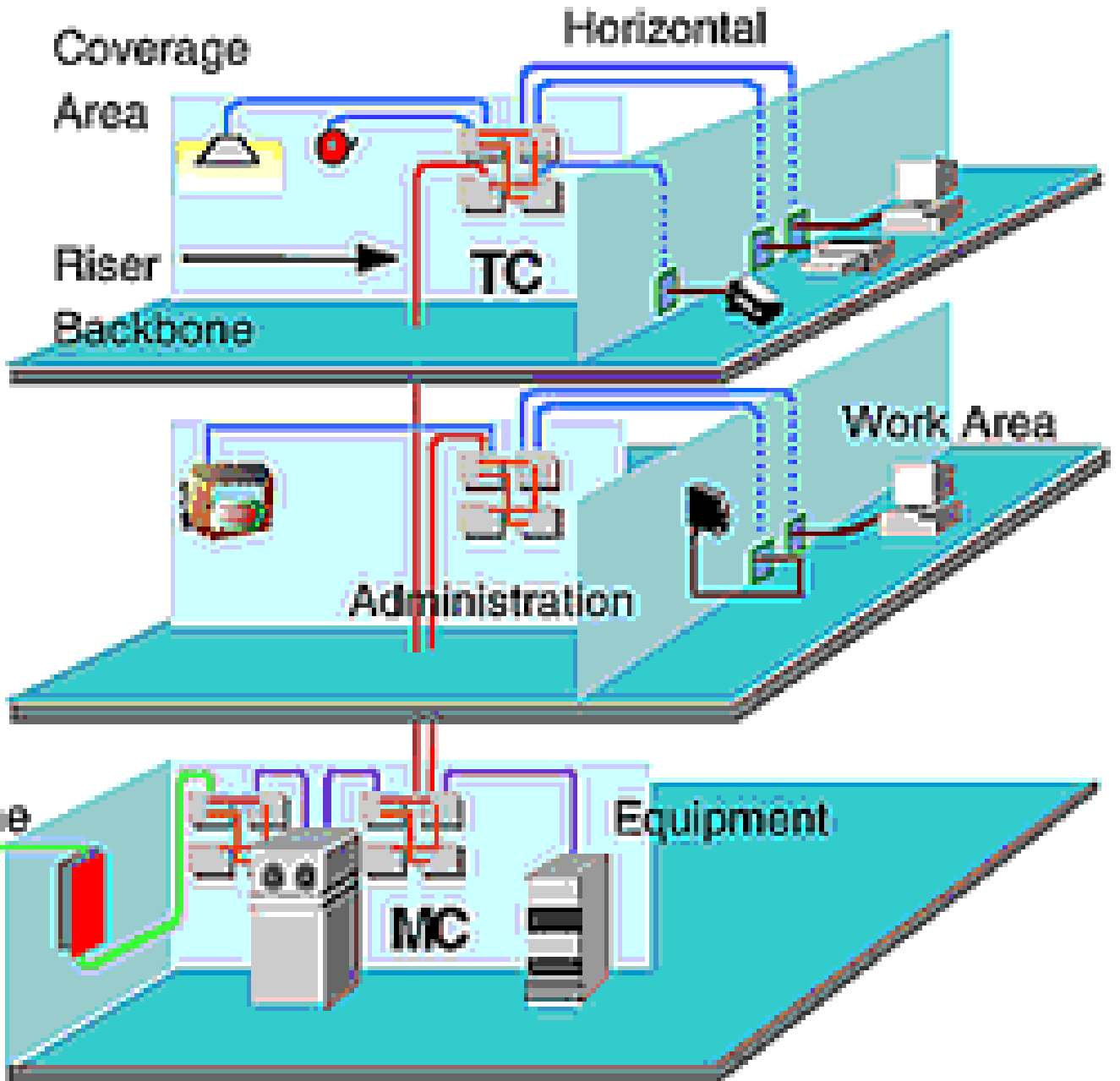

(\* Video: What is Structured Cabling Standard (TIA-568-C)? (5:48)

[http://www.youtube.com/watch?v=NRE6O\\_mvFus](http://www.youtube.com/watch?v=NRE6O_mvFus))

## Six subsystems of structured cabling

<p><b>1. Entrance Facilities</b> The point where the telephone company network ends and connects with the on-premises wiring at the customer premises</p>	<p><b>4. Horizontal Cabling</b> Inside wiring or plenum cabling that connects telecom rooms to individual outlets or work areas on the floor</p>
<p><b>2. Equipment Rooms</b> House equipment and wiring consolidation points that serve the users inside the building or campus</p>	<p><b>5. Telecommunications Rooms or Enclosure</b> Connects between the backbone cabling and horizontal cabling</p>
<p><b>3. Backbone Cabling</b> Connects between the equipment/telecom rooms on different floors</p>	<p><b>6. Work-Area Components</b> Connect end-user equipment to outlets of the horizontal cabling system</p>



Video: What are the Structured Cabling System Components? (8:13)

<https://youtu.be/xDbiT3IwNpE>

# Typical structured cabling components

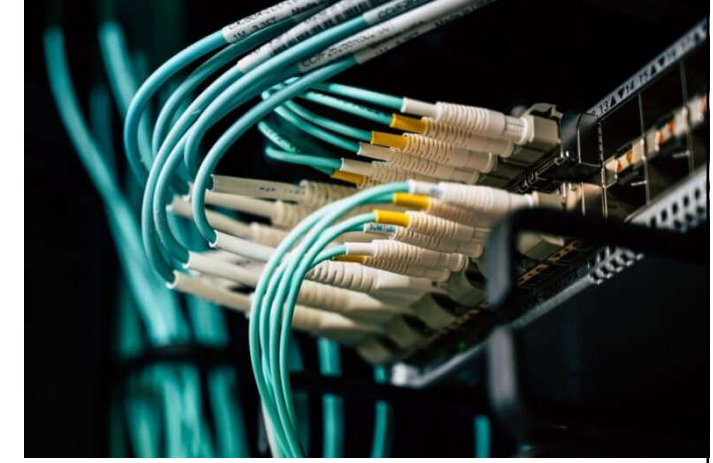
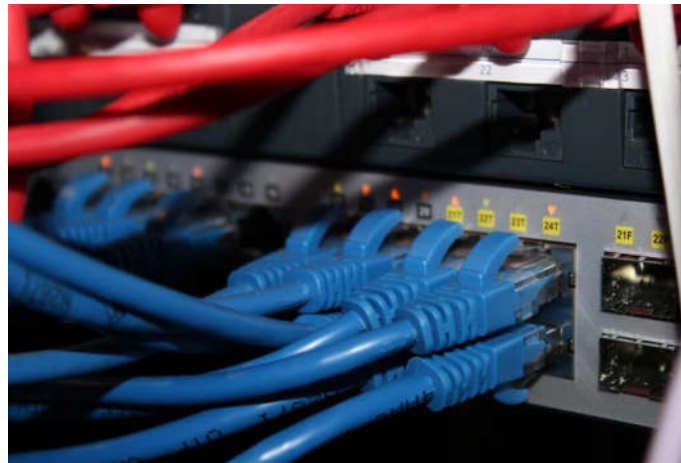
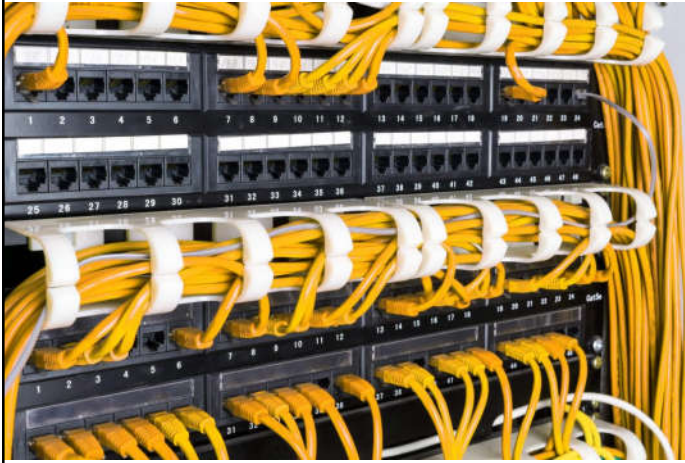

## Patch Panels

A patch panel connects cables. They're also called patch bays and are attached to network racks. Patch panels use cords to connect to a switch.

## Switches

A switch is a component of the system that receives, processes and sends data. The switch connects your patch panels so you can connect devices to a network and share data and access the internet.

## Trunk Cables

A trunk is a cable that connects to patch panels, consolidating the number of wires running from patch panel to patch panel. They're essentially a grouping of wires that are bound into one big cable to keep everything neat and organized.

# Typical telecommunication equipment room



(Source: <http://www.fiber-optical-networking.com/key-components-form-structured-cabling-system.html>)

# Structured cabling for local area network in a building

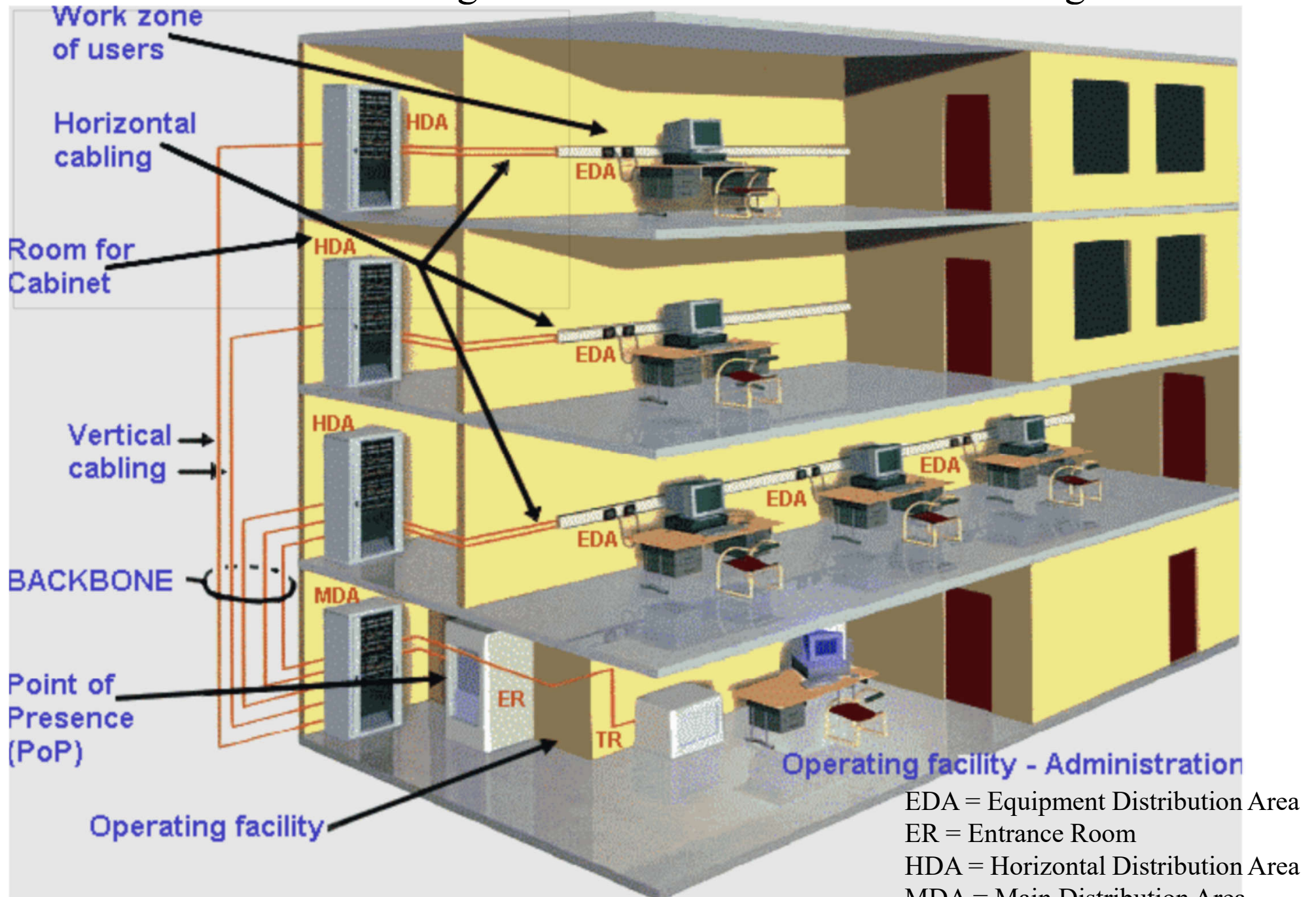

# Topological scheme of structured cabling

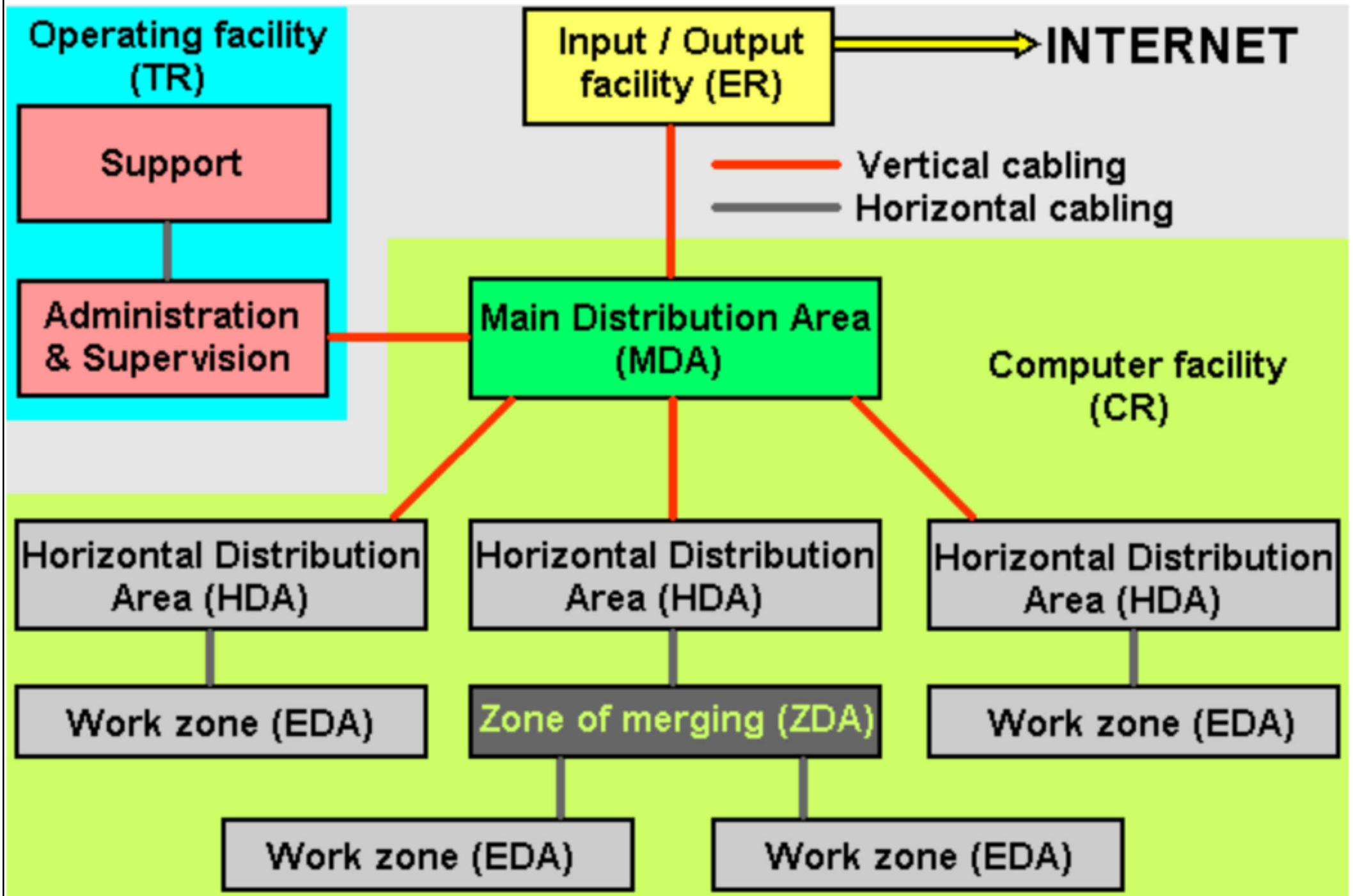

# Topological scheme connection of network devices

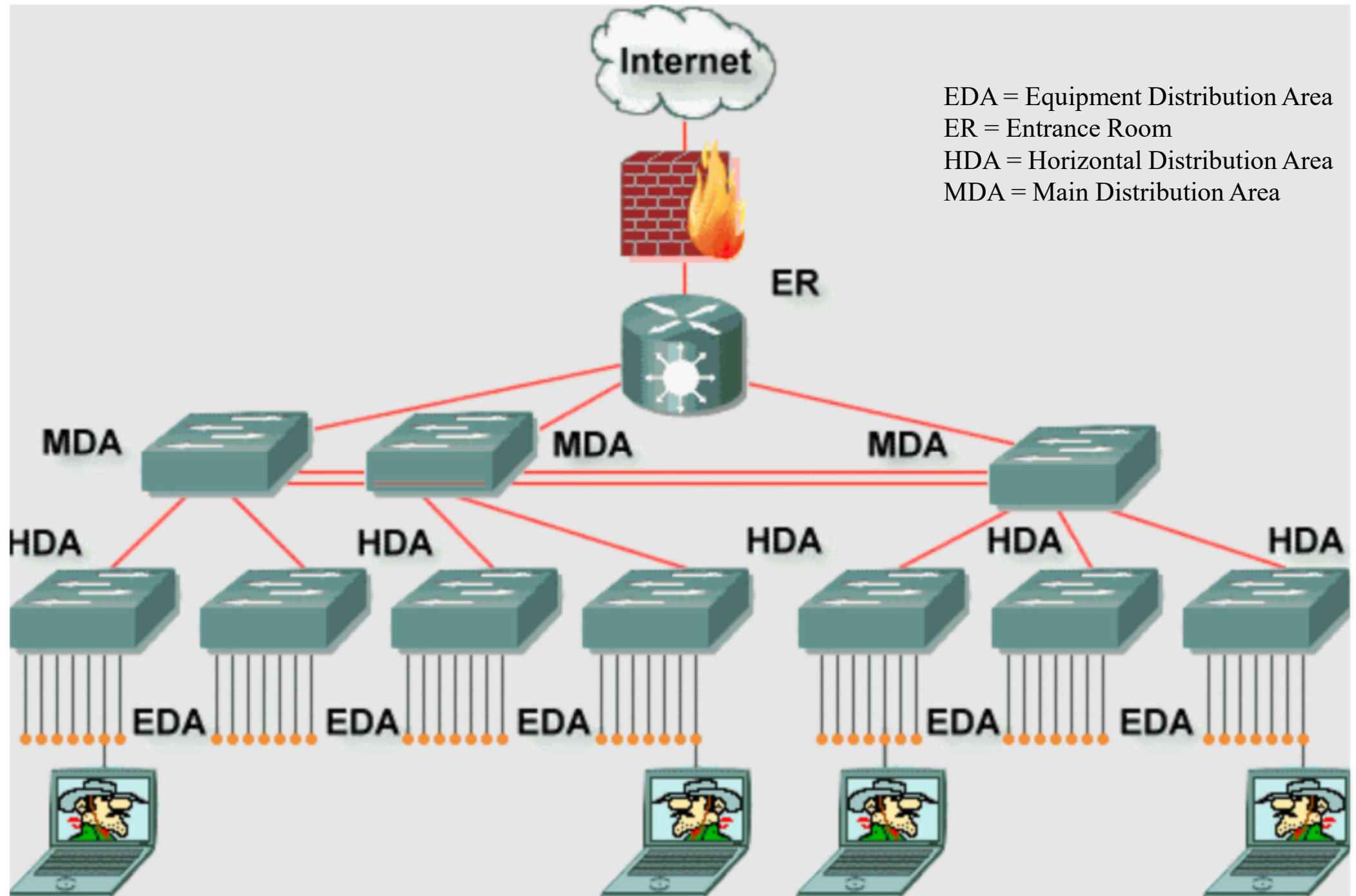

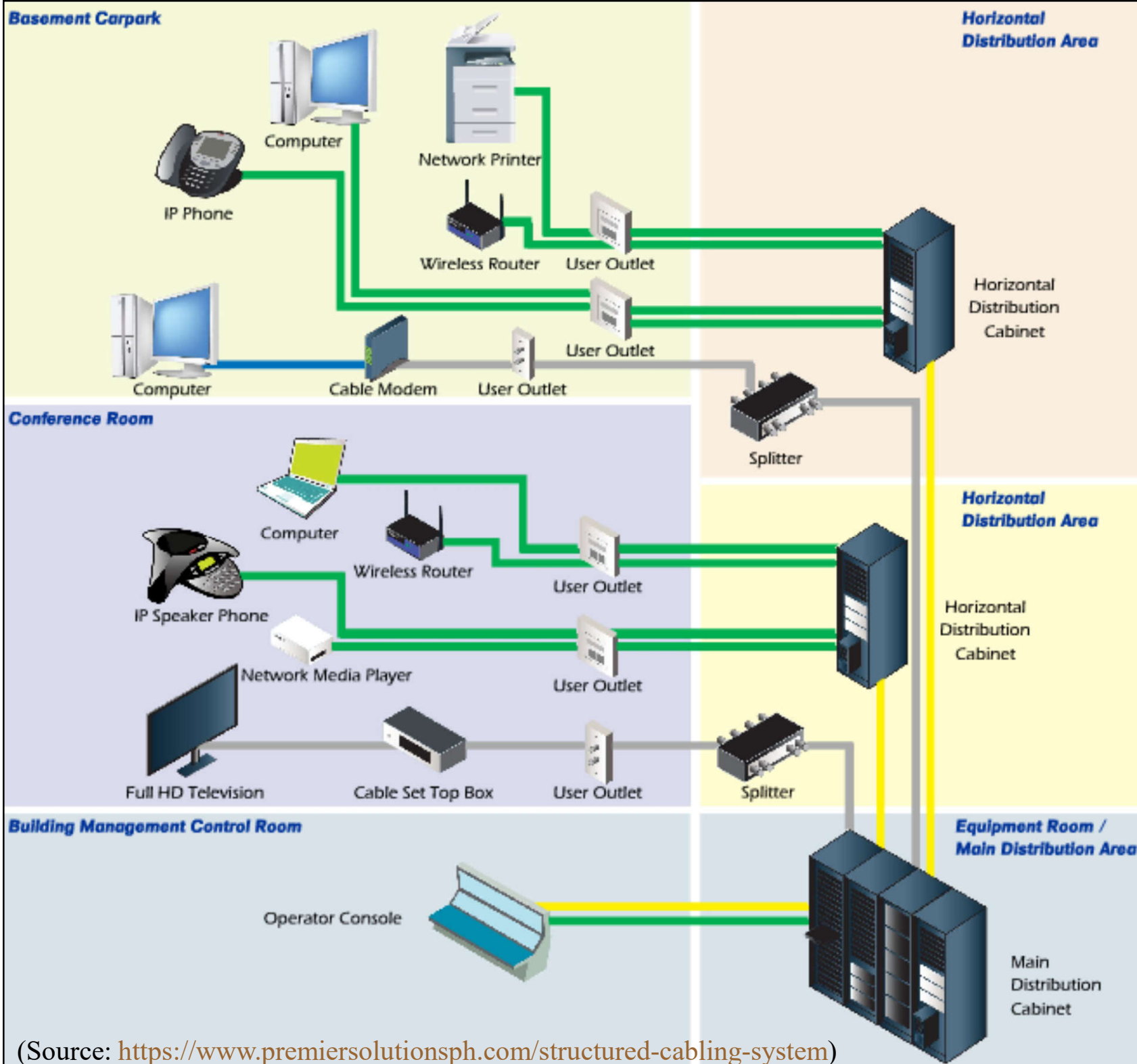

Application example of structured cabling systems



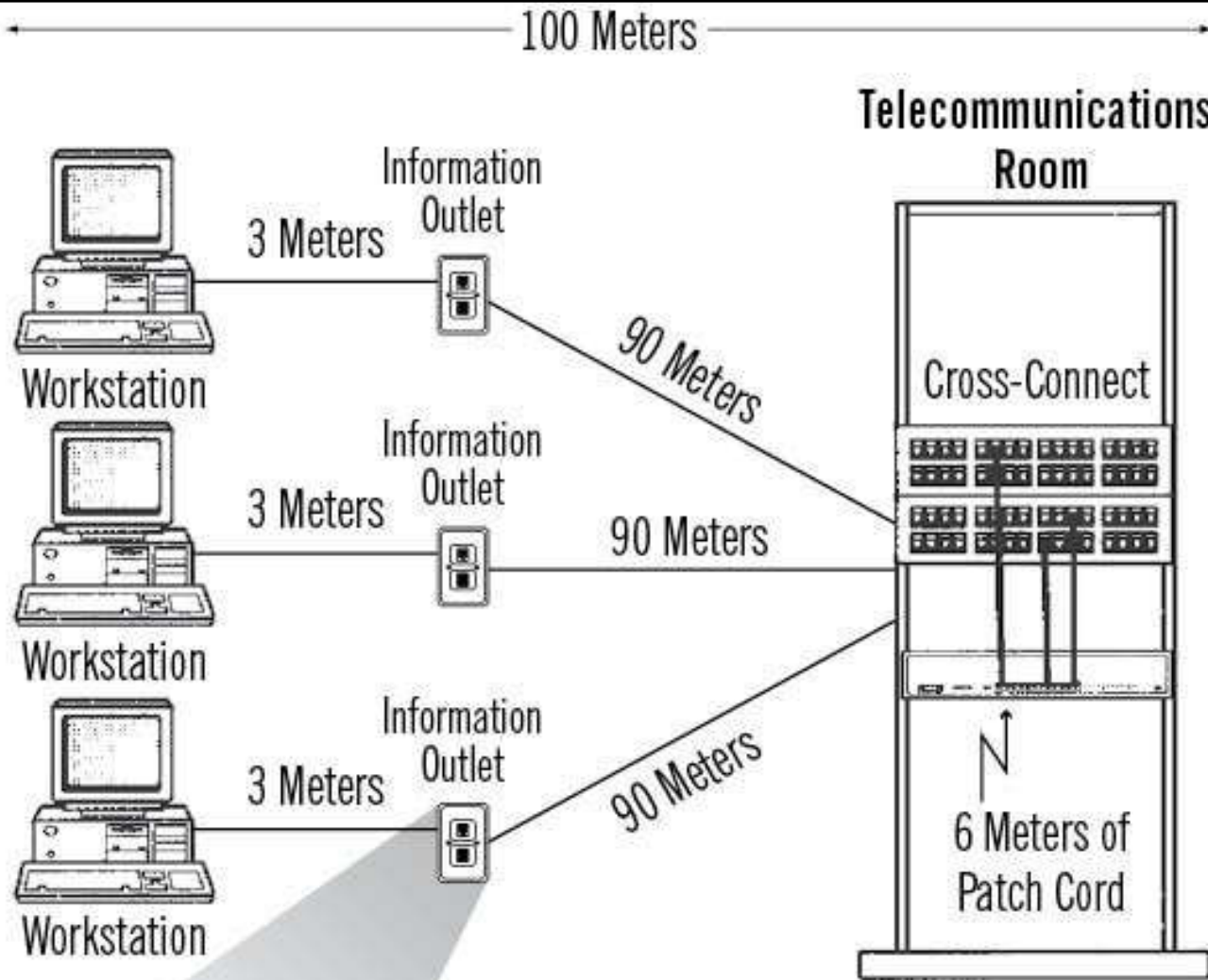

Horizontal cabling system & maximum cable length

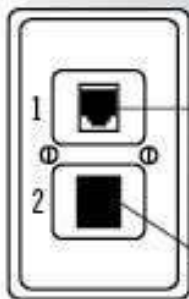

100 Ohm, UTP/ScTP 4-pair for voice  
T568A or T568B wiring

100 Ohm, UTP/ScTP 4-pair 62.5/125  $\mu\text{m}$  fiber for data or 50/125  $\mu\text{m}$  fiber for data

# Cabling management



- Steps to design a structured cabling system
  - 1. Select the standards to follow (e.g. ISO 11801, EIA/TIA 568)
  - 2. Horizontal cabling
  - 3. Backbone cabling
  - 4. Positioning & design of telecomm closets
  - 5. Cable containment system
  - 6. Cable administration system
  - 7. Earthing scheme & testing

# Cabling management



- Cable routing recommendations
  - Data & voice follow the same routes
  - Good labelling for identification
  - Duplicate routes (increase reliability for high priority equipment)
  - Secondary distribution: most demanding
    - Normally follows a rectangular grid (street & avenue)
  - Allow for future expansion/changes

# Cabling management



- Distribution strategy
  - Cabling routes, capacity, distribution methods, outlet types, flexibility & allowance for future growth
  - Major requirements:
    - Primary plant locations & sub-distribution points
    - Load centres
    - Management and maintenance
    - Redundancy & extension allowance
    - Cable types & termination facilities
    - Flexibility

# Networking



- What is a (computer) network?
  - Simply, a collection of computers and other devices connected in a way that allows them to share information and resources.



- Why Network?
  - Devices can be shared
  - Easier to manage
  - Easier to maintain
  - Less expensive for equipment & software



# Office/Enterprise computer network

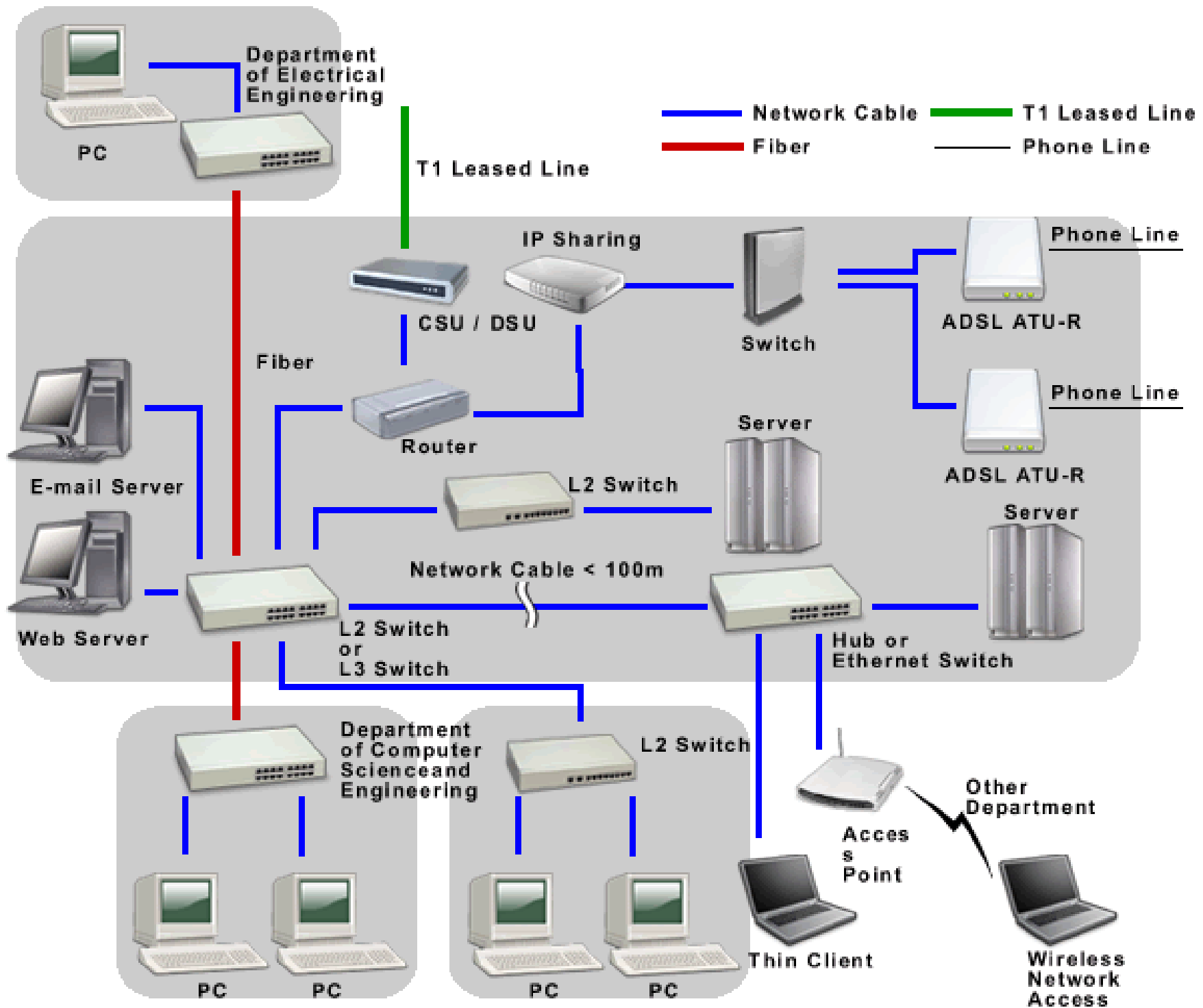

# Networking



- Local area network (LAN)
  - A computer network that spans a relatively small area, and with high-speed switched connections
- Wide area network (WAN)
  - A system of LANs connected over any distance via telephone lines and radio waves
- Other types of network
  - Metropolitan area network (MAN)
  - Campus area network (CAN)
  - Home area network (HAN)

# Internetworking concept

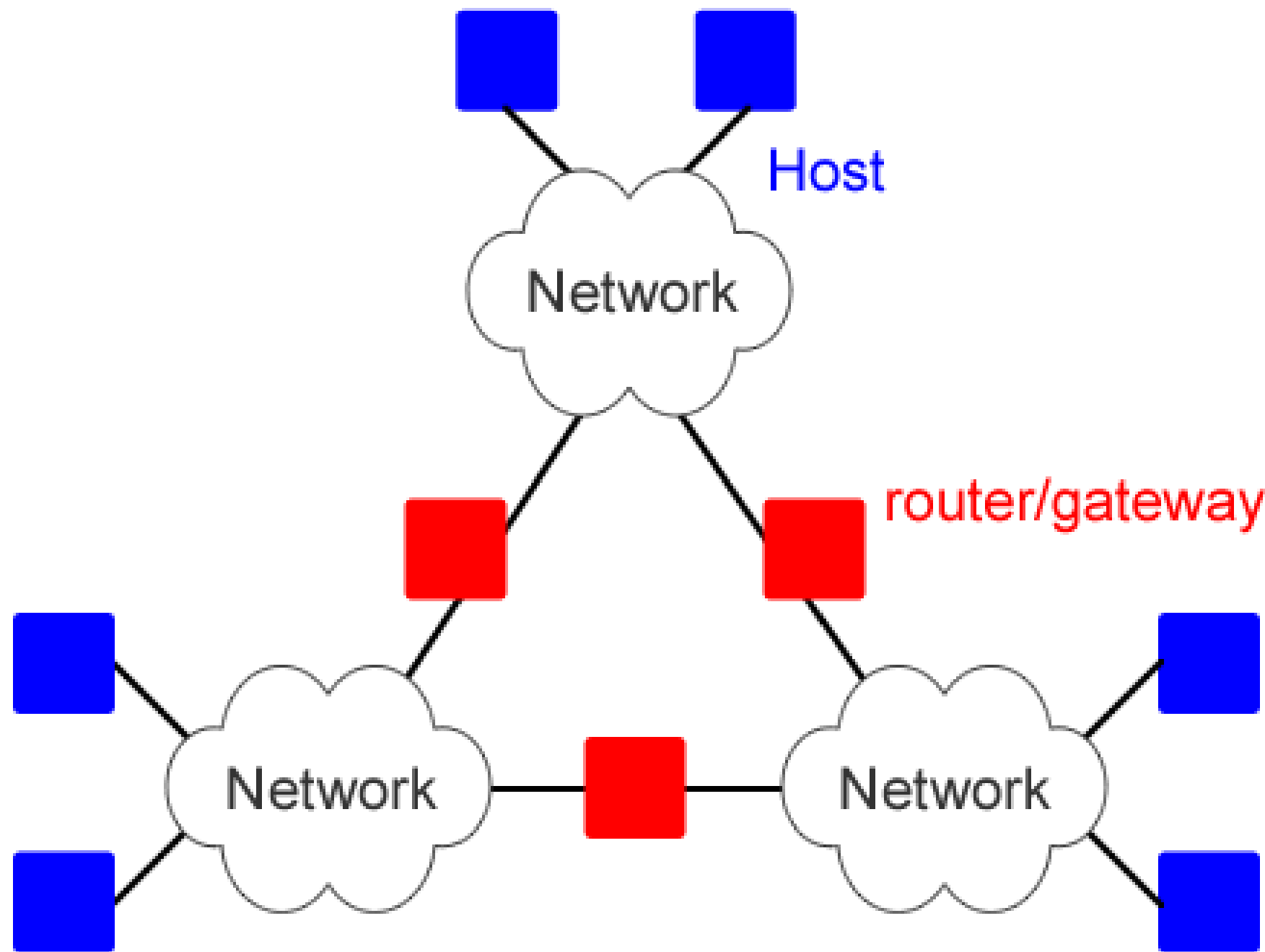



# Local Area Network (LAN)

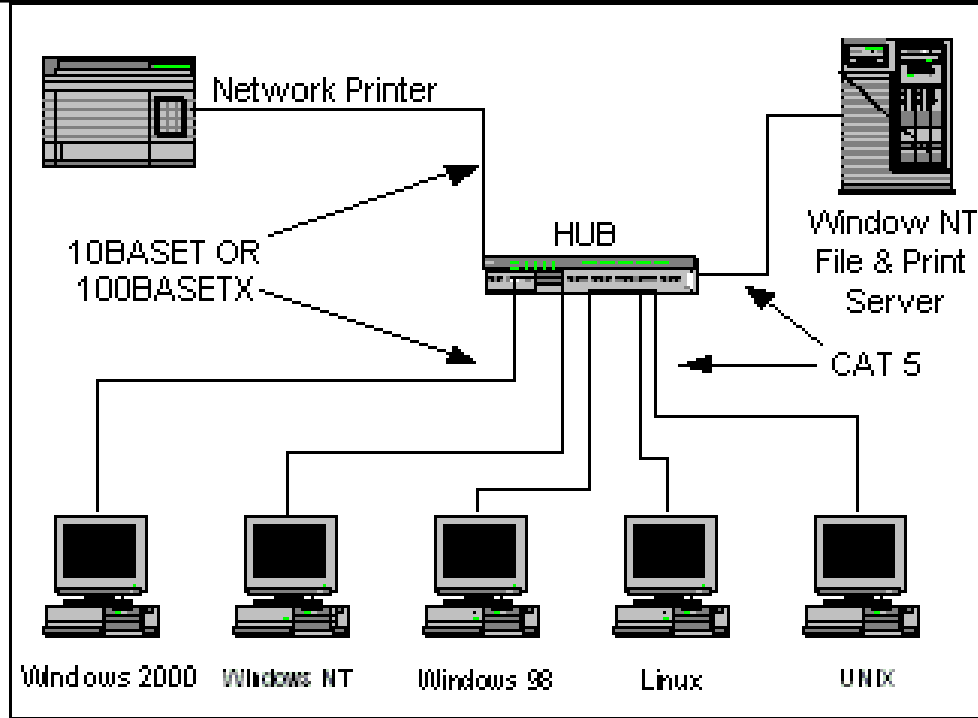

Local Area Network

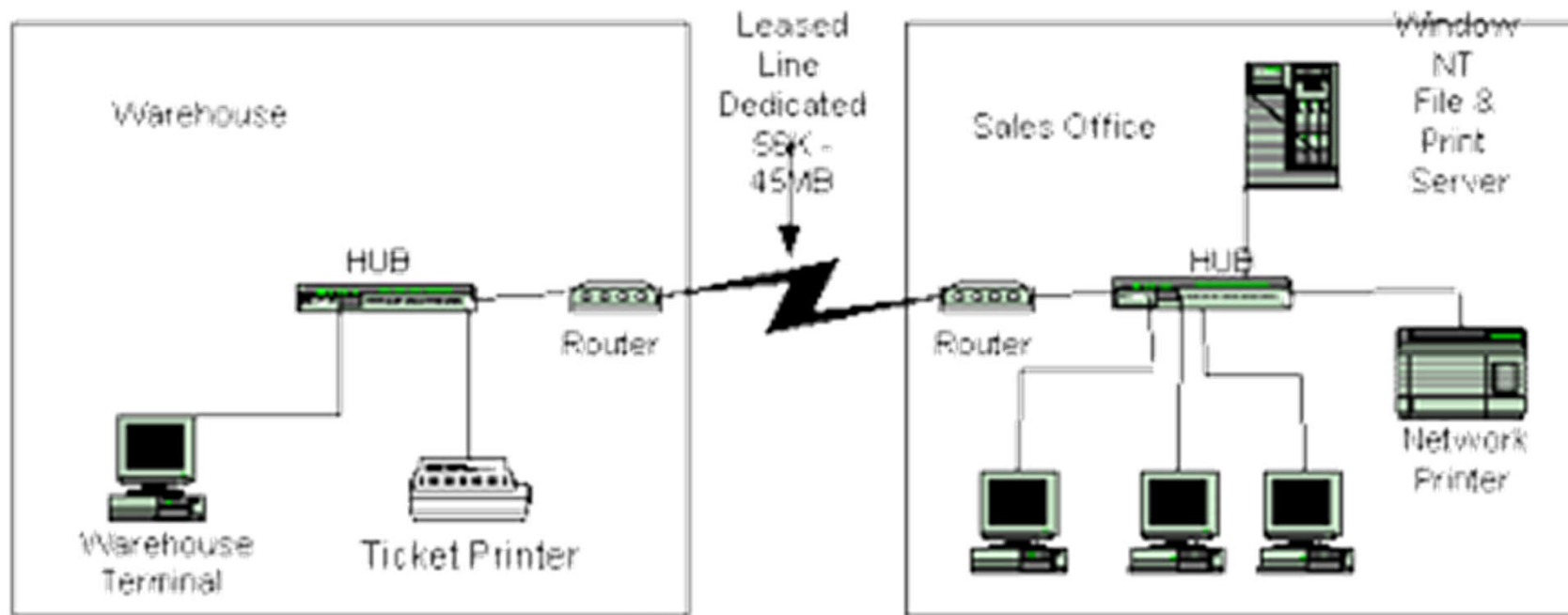

Wide/Metropolitan Area Network (WAN/MAN)

# Example of network infrastructure -- HKU

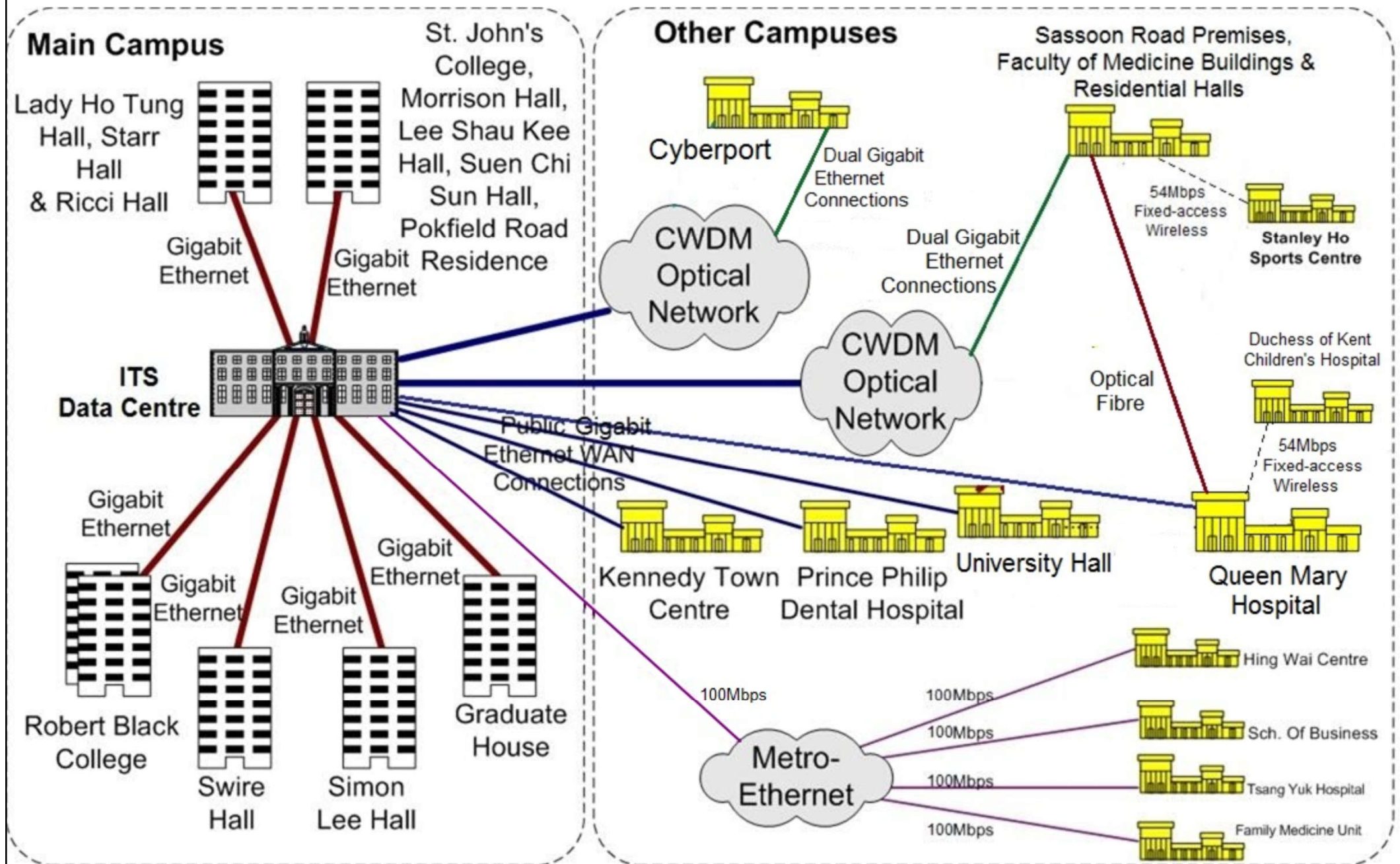

**Computer Network of HKU Remote Campuses and Residential Halls**

# SIMPLIFIED HKUST CAMPUS NETWORK SCHEMATIC

(Last Updated In SEP 2015)

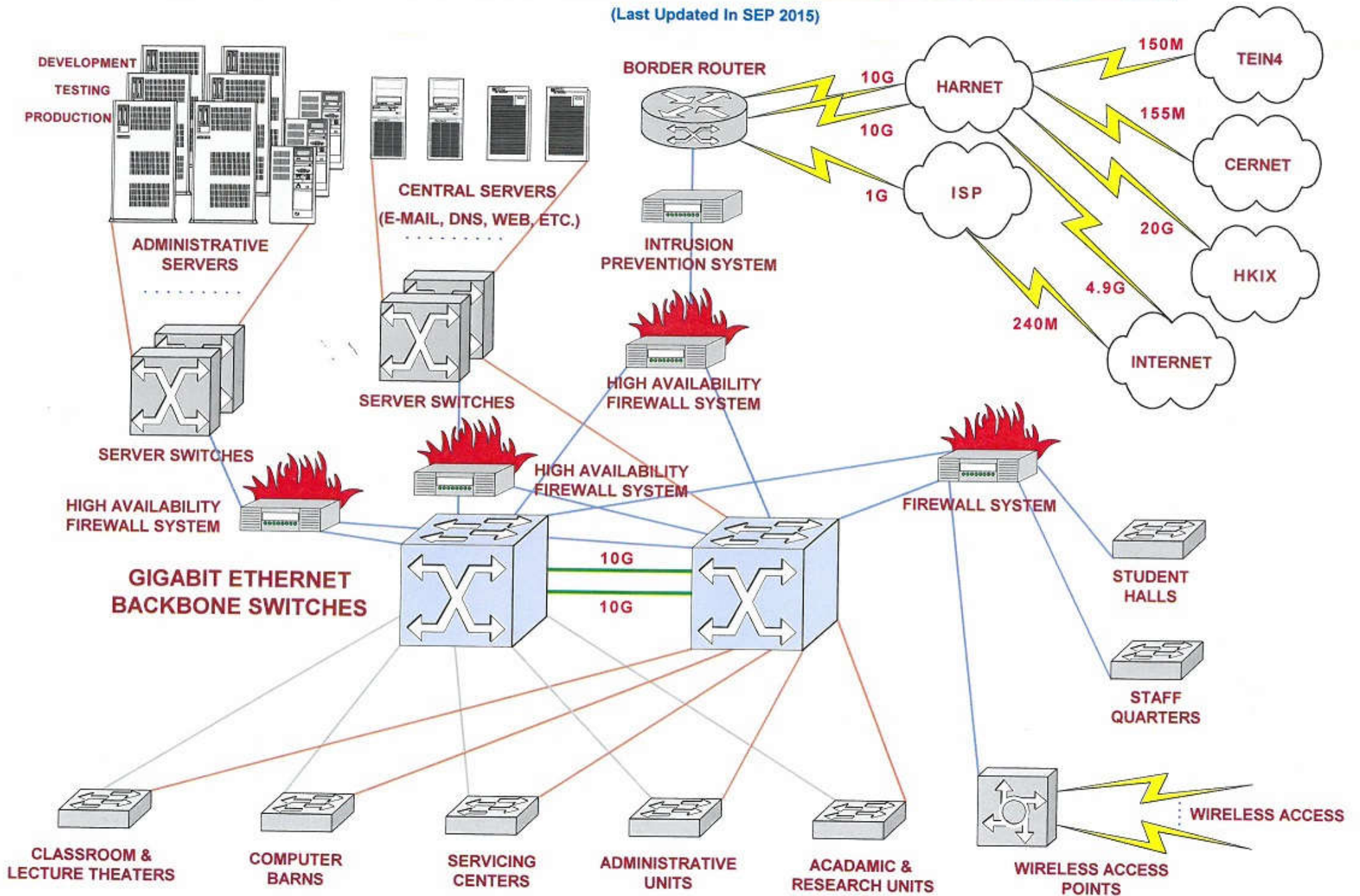

(Source: <https://itsc.ust.hk/services/it-infrastructure/network-infrastructure/schematic>)

# Networking



- Common LAN standards
  - Ethernet
    - ISO 8802-3 by Digital Equipment Corp., Intel Xerox
    - Peer-to-peer connection: carrier sense multiple access w/ collision detection (CSMA/CD)
    - Speed: 10 to 100 Mbps
  - ARCNET
    - ARCNET = Attached Resource Computer Network
    - Developed by Data Point Corp.
    - Star or bus topology, peer-to-peer token-passing
    - Speed: 2.5 Mbps

# Example of Ethernet system

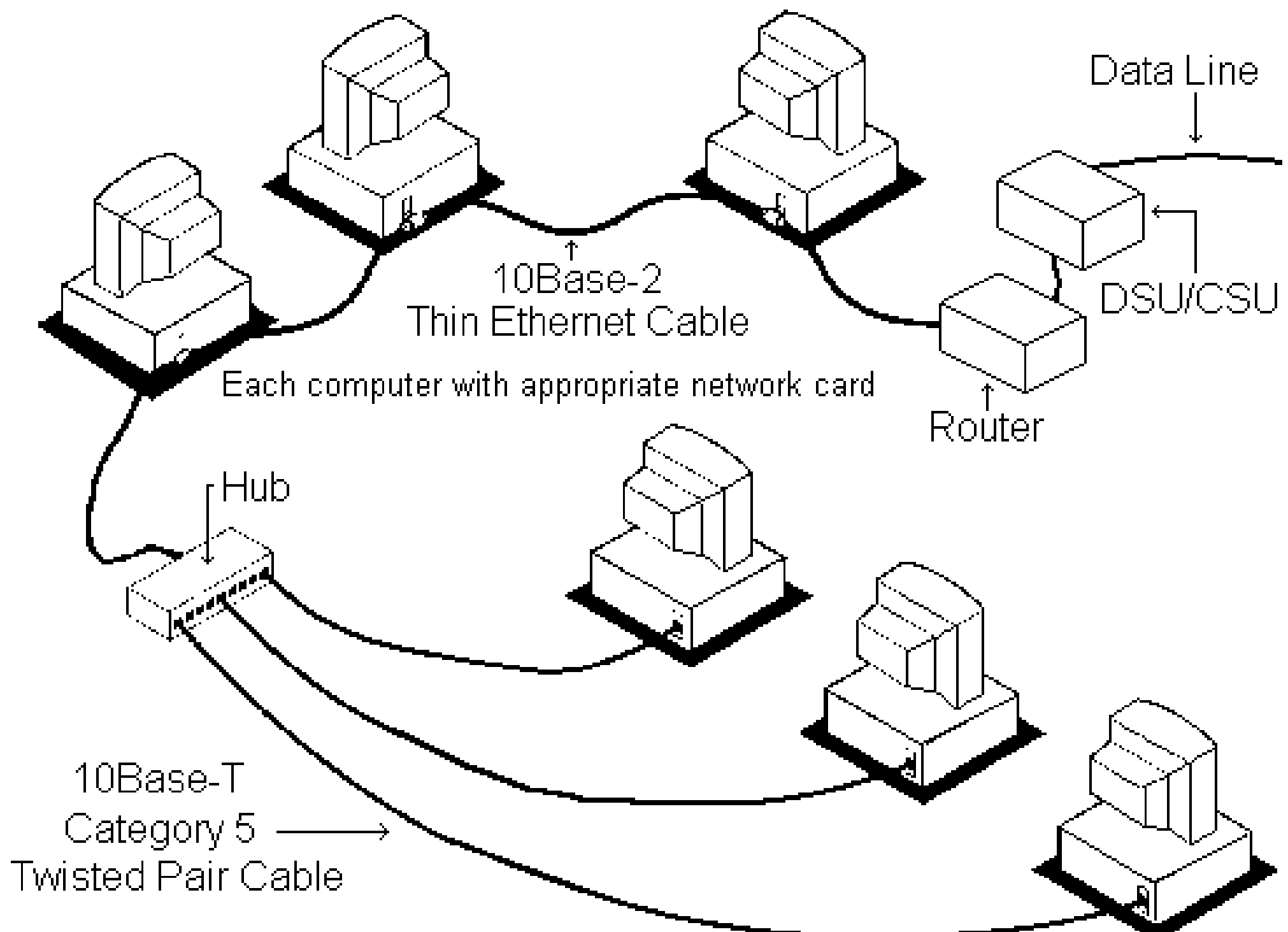

Data Line

10Base-2  
Thin Ethernet Cable

DSU/CSU

Each computer with appropriate network card

Router

Hub

10Base-T  
Category 5  
Twisted Pair Cable

# Ethernet port and connector

## Ethernet Port

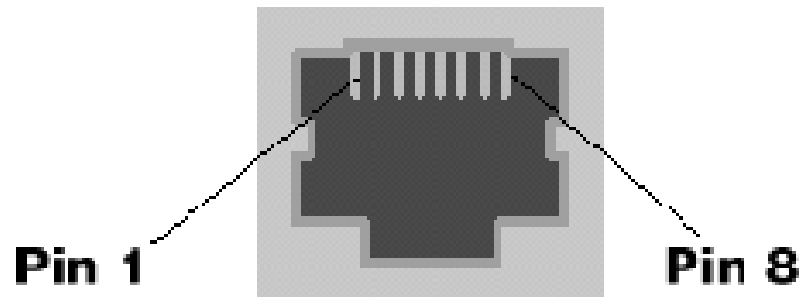

“100 Base T” means:

- 100 Mbps
- Baseband signal
- Twisted pair

## RJ-45 Connector

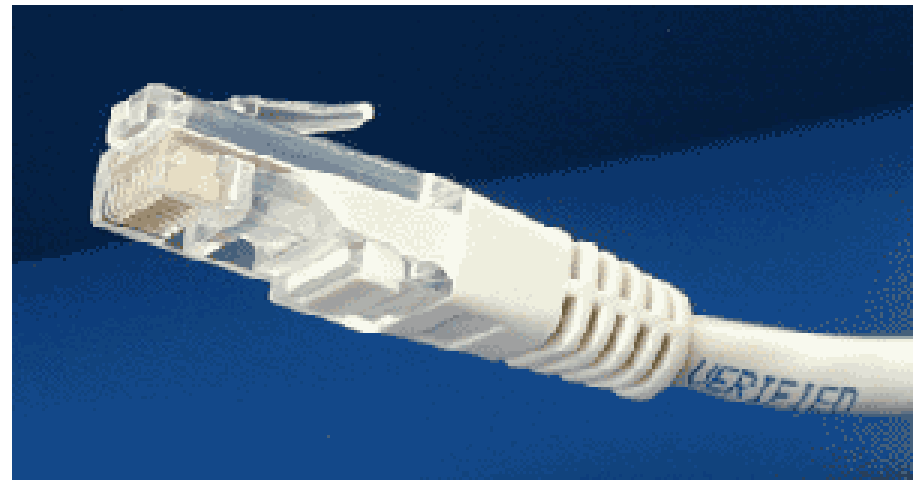
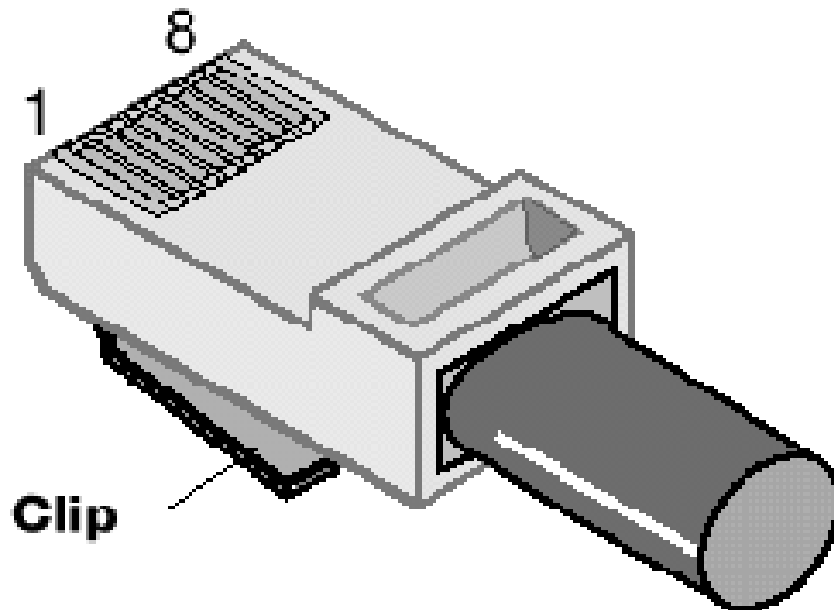

RJ-45 = Registered Jack-45 (8-wire)  
(RJ-11: for telephone, 4- or 6-wire)

# Networking



- Network speed

- How fast is fast? (time to transmit 10MB of data)

- 28.8 kps modem: 5 minutes
    - 56 kps modem: 26 min. 20 sec.
    - 128 kps (ISDN): 10 minutes
    - 1.544 Mbps (T-1): 50 seconds
    - 10 Mbps (10BaseT): 8 seconds
    - 100 Mbps (100BaseT): 0.8 seconds
    - 1000 Mbps (1000BaseT): 0.08 seconds
    - 10 Gbps (10GBaseT): 0.008 seconds

The world is  
going Gigabit!

# Networking



- Leading official standards organisation
  - IEEE 802 LAN/MAN Standards Committee ([www.ieee802.org](http://www.ieee802.org)) and its working groups
    - 802.1: interface between OSI levels 1 & 2 with five higher level layers (OSI = Open Systems Interconnection)
    - 802.2: logical data link
    - 802.3: CSMA/CS (carrier sense multiple access with collision avoidance)
    - 802.4: Token bus
    - 802.5: Token ring





# Communication of building sub-systems using open system framework

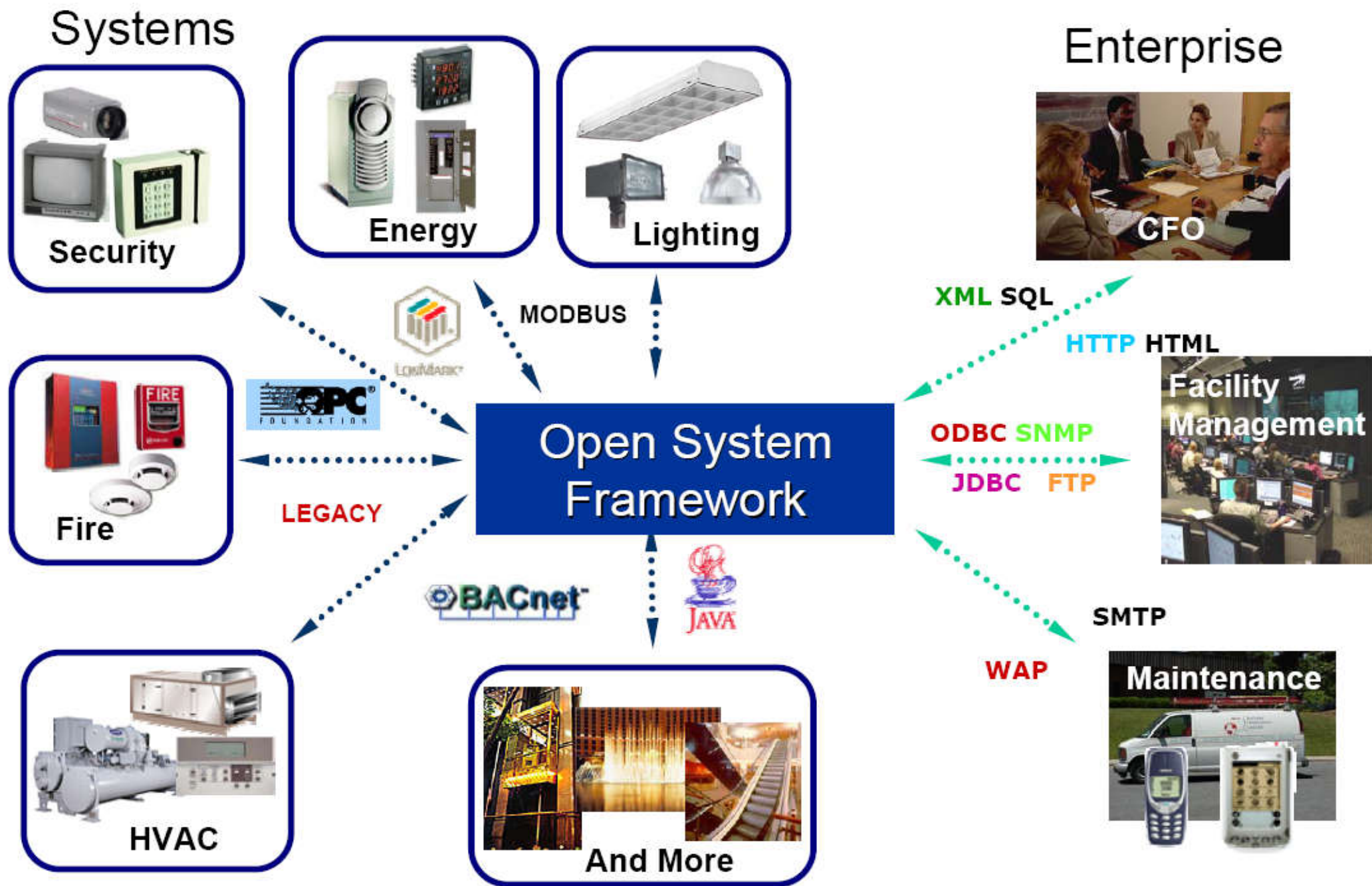



# Transmission methods

- Media/transmission methods

- Twisted pairs (TP)

- Two insulated conductors twisted together to minimise interference by unwanted signals

- Line bandwidth (300-3000 Hz)
      - Signal-to-noise ratio
      - Conditioning (of the line)

- Conditioned line has speed up to 9600 bps

- In most cases, 1200 bps is maximum

- Unshielded twisted pairs (UTP)

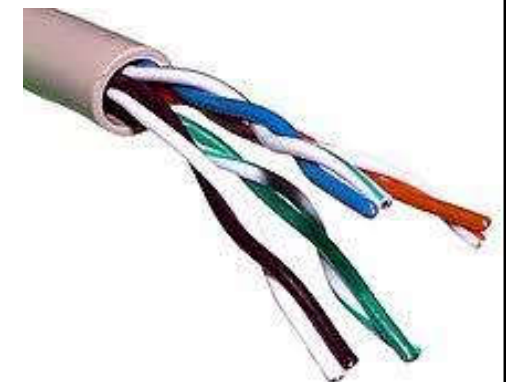
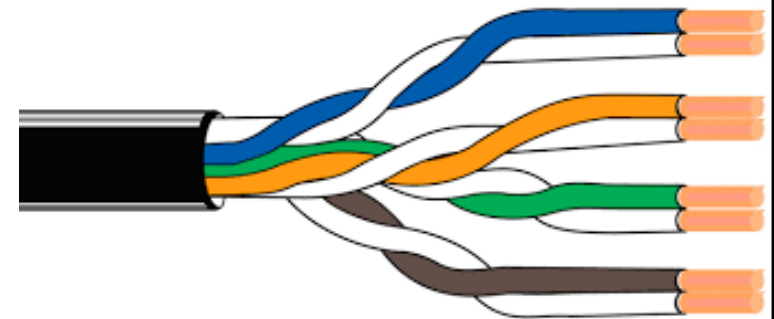

# Twisted pairs (TP)



**Unshielded twisted-pair**

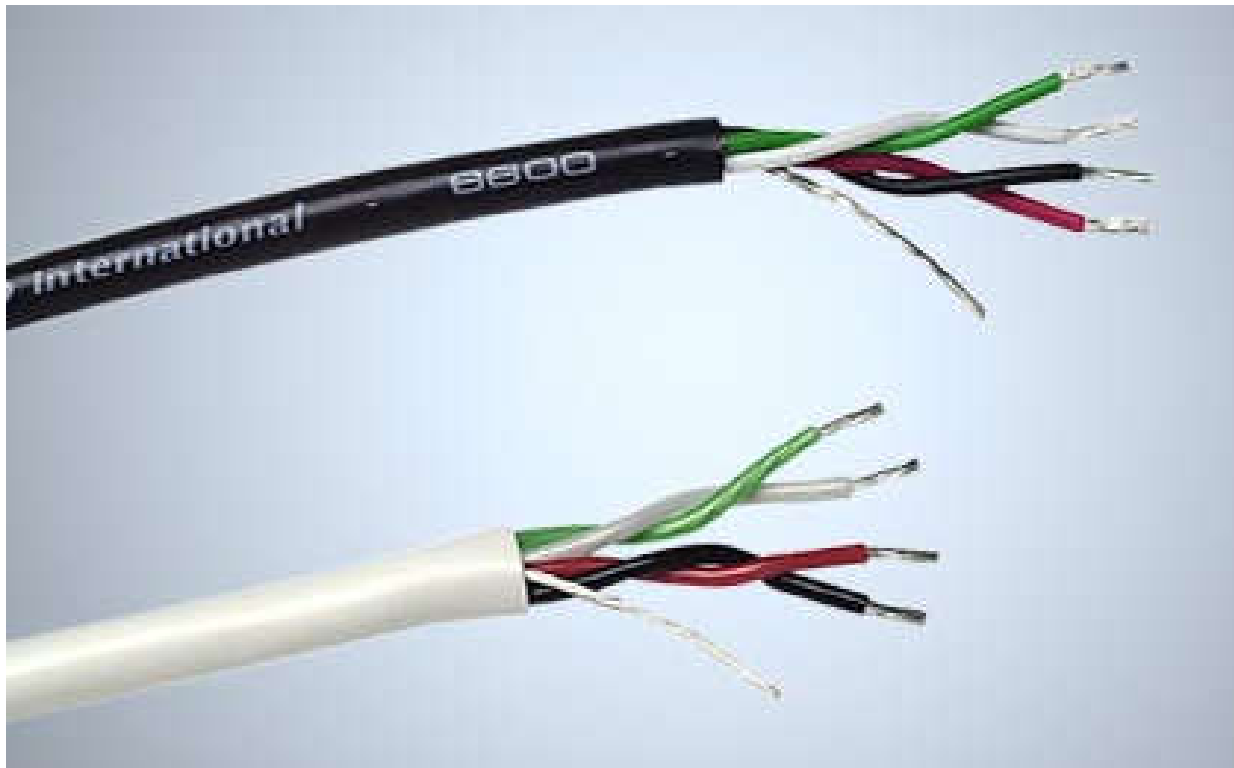

**Foiled twisted-pair**

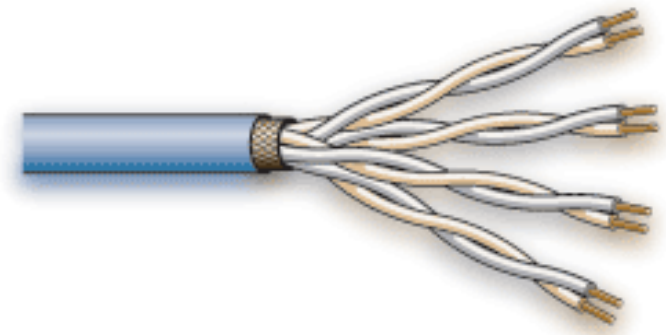



# Transmission methods

- Media/transmission methods (cont'd)
  - Voice grade lines
    - Type 3002 in in the Bell Telephone Company's standard BSP41004
  - Coaxial cable
    - Centre conductor surrounded by a shield
      - Electromagnetic interference
  - Power lines
    - Using carrier current transmission that superimposes a low RF signal (100 kHz) onto the 50/60 Hz power distribution system

# Coaxial cable

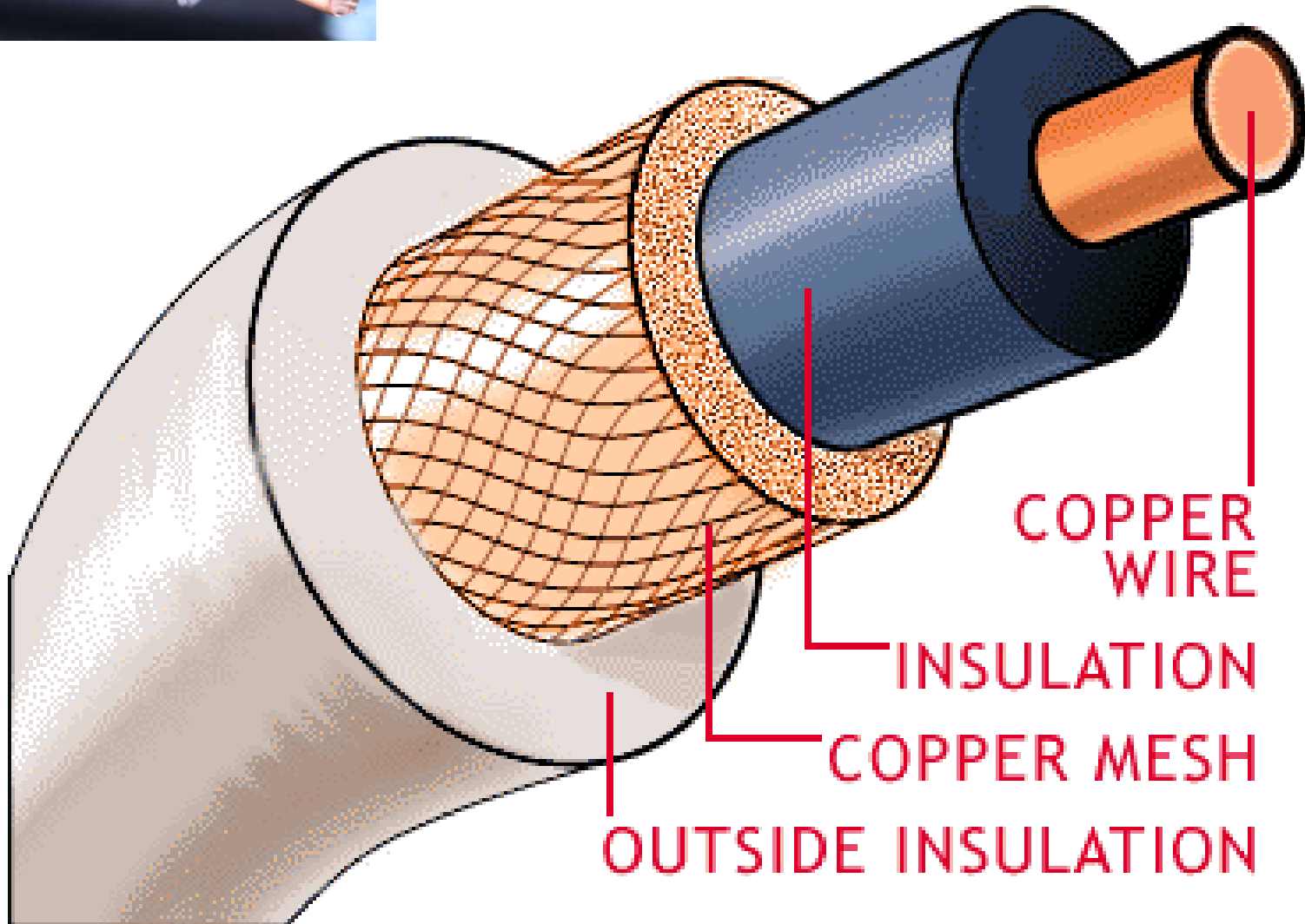
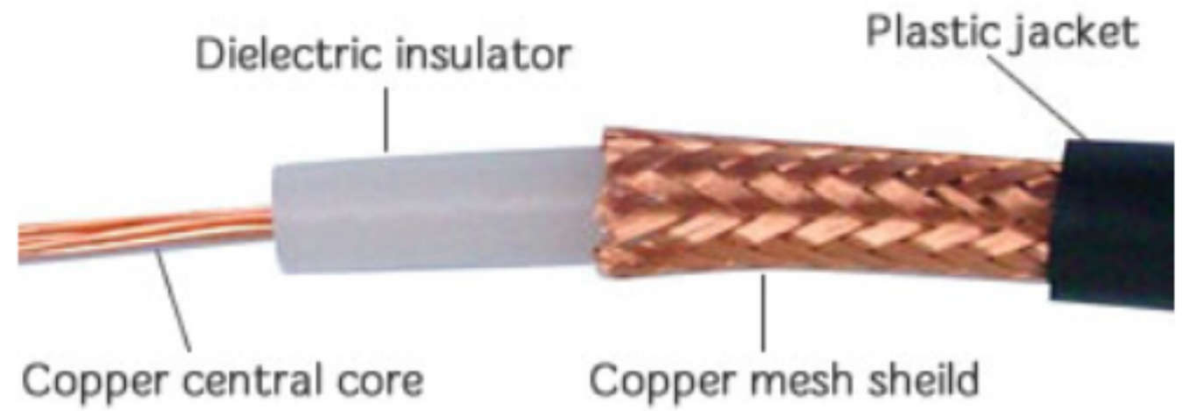
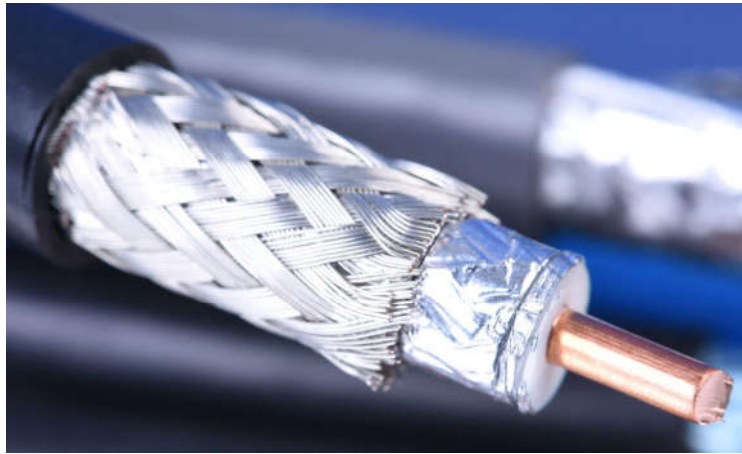

# Power line transmission and communication

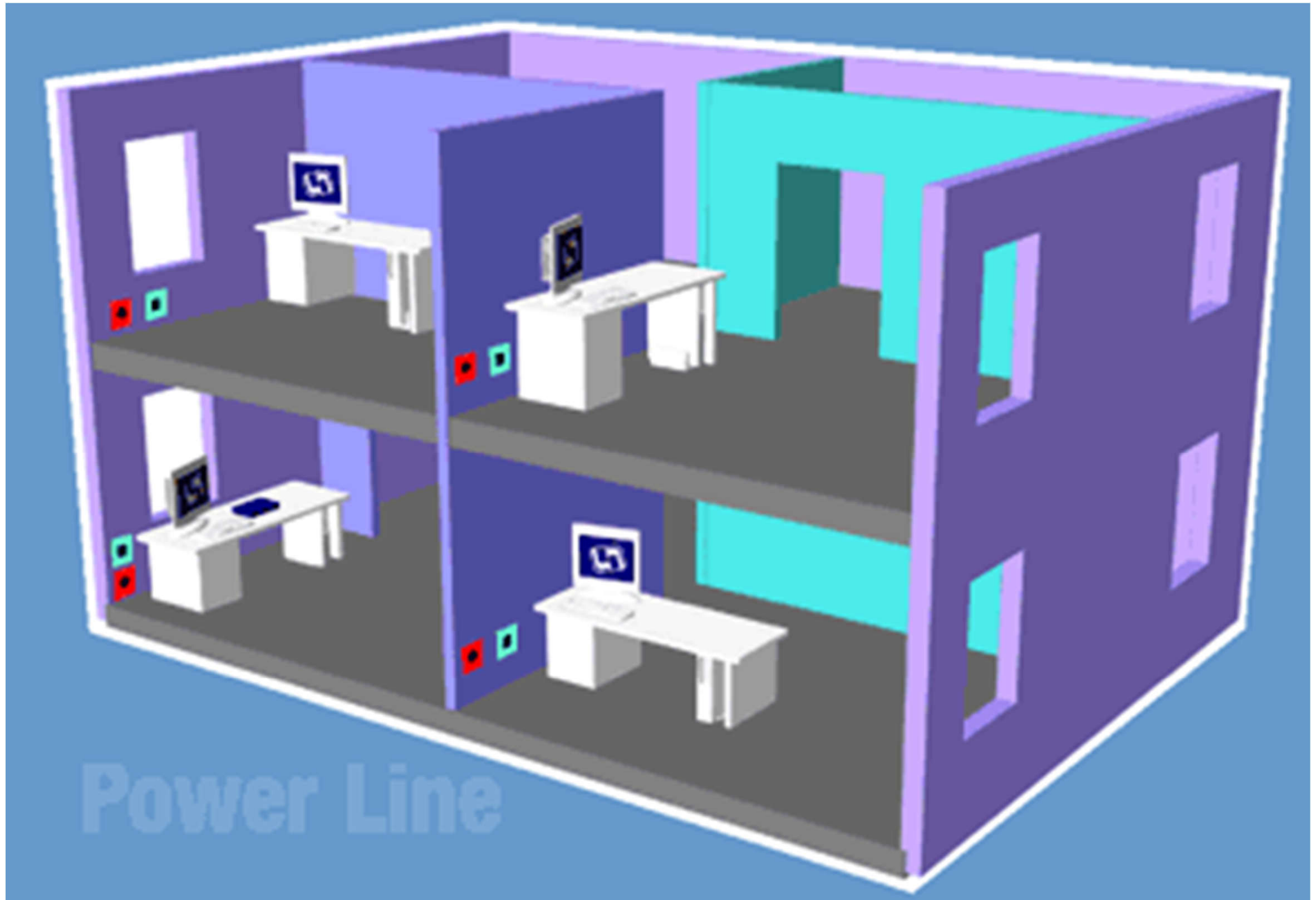



# Transmission methods

- Media/transmission methods (cont'd)
  - Radio frequency (RF)
    - Modulated RF, with radio receivers and transmitters
  - Microwave
    - Used by TV stations, very high cost
  - Fibre optics
    - Infrared light travelling through transparent fibres
    - Best suited for point-to-point high speed transmission
    - Bandwidth virtually unlimited

# Fibre optics transmission

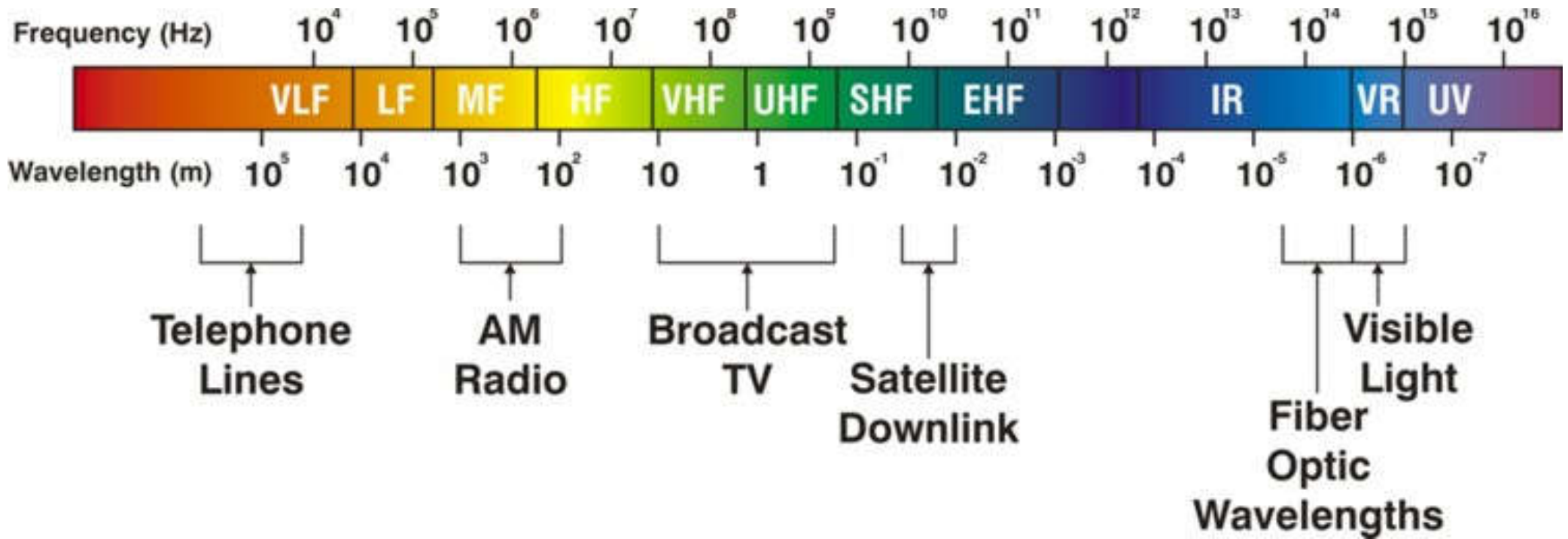
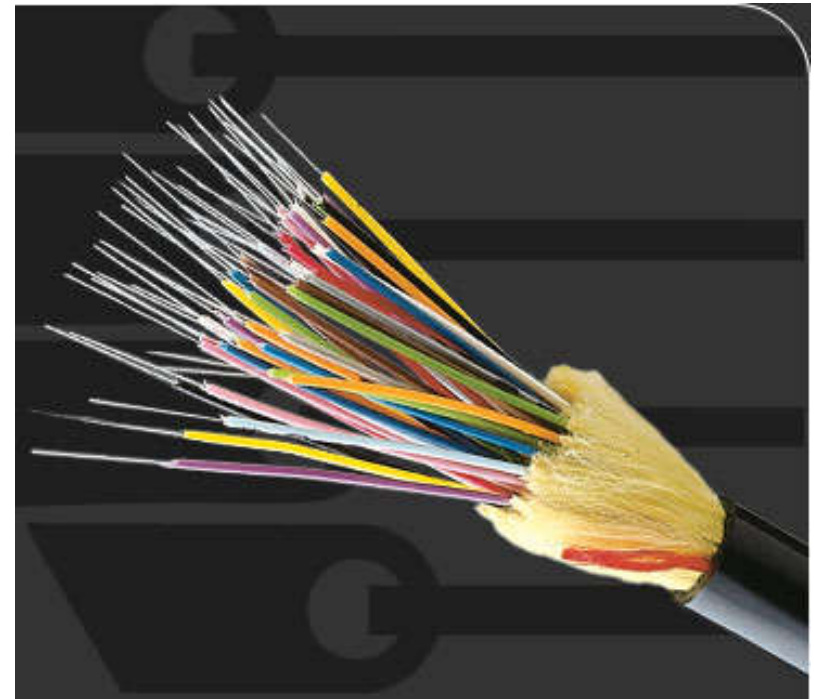
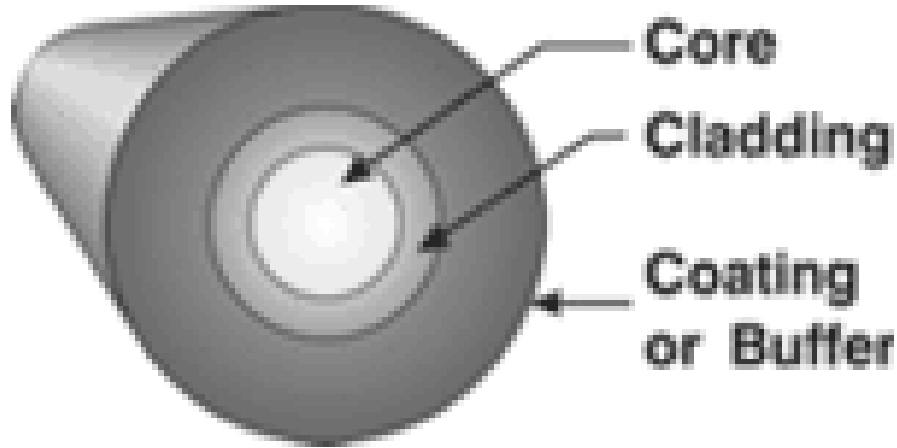



# Comparison of transmission methods

<b>Method</b>	<b>First cost</b>	<b>Scan rates</b>	<b>Reliability</b>	<b>Maint. Effort</b>	<b>Expand-ability</b>	<b>Compati-bility</b>
Coaxial	High	Fast	Excellent	Min.	Unlimited	Unlimited
Twisted pair	High	Medium	Very good	Min.	Unlimited	Limited
Radio frequency	Medium	Fast but limited	Low	High	Very limited	Very limited
Microwave	Very high	Very fast	Excellent	High	Unlimited	Unlimited
Telephone	Very low	Slow	Low to high	Min.	Limited	Limited
Fibre optics	High	Very fast	Excellent	Min.	Unlimited	Unlimited



# Transmission methods

- Wireless communication
  - Transfer of information between two or more points that are not connected by an electrical conductor, such as radio & infrared controller
- Modern wireless technologies
  - Digital devices that communicate without wires
    - Such as mobile phones & wireless networking
  - 4G LTE (long-term evolution), LTE-Advanced, 5G
  - Wi-Fi (wireless LAN), Bluetooth



# Evolution of mobile phone communications

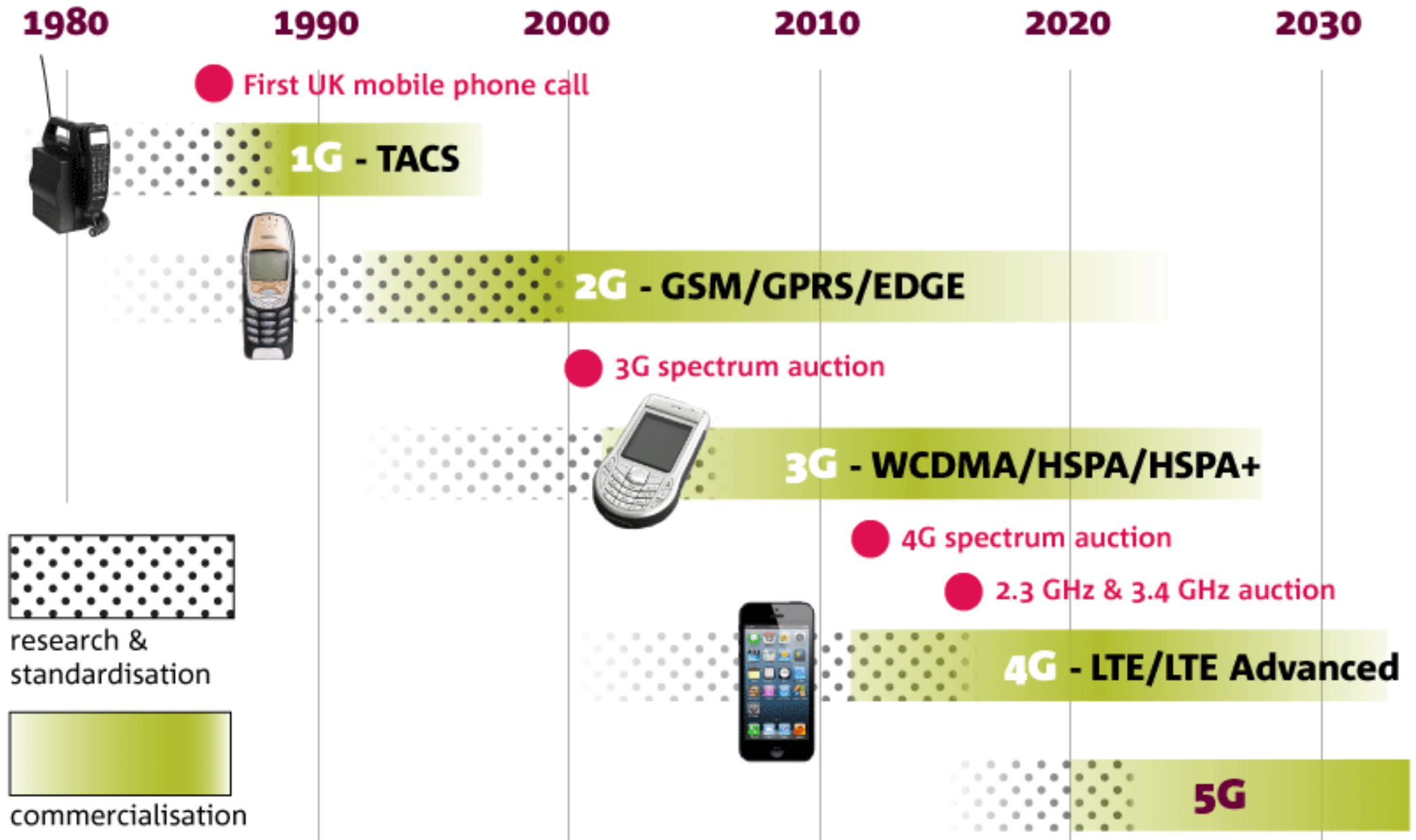

# Fixed wireless network evolution



# Wireless technology evolution

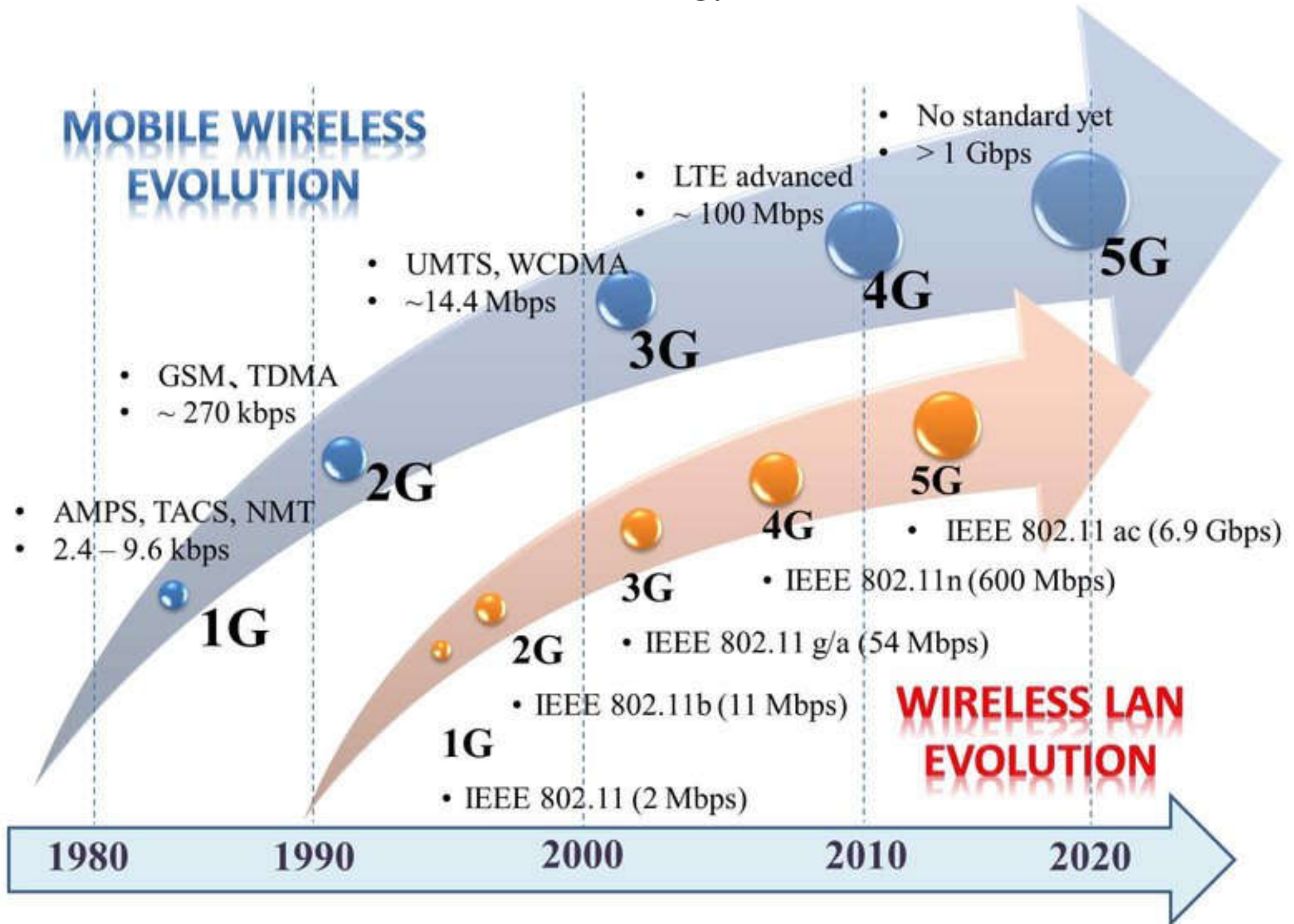

# In-building wireless systems



- Mobility of people and business
  - Mobile devices become a must
    - “One person one number” + Voice to data
  - 70%+ of mobile traffic occurs inside buildings
  - Full in-building coverage is essential (e.g. lift cars)
- Indoor systems should be pre-installed, like other utilities in the building
  - Covering areas of high user density
  - Keep the building users “Happy”





# In-building wireless systems

- Telecommunications infrastructure or Internet broadband as the “*Fourth Utility*”, after electricity, water & gas
  - Reliable connectivity without restriction – all the time, at full speed, on any device, from anywhere – has become the expectation in our connected world
  - Indoor access to Wi-Fi, cellular & VoIP networks
  - In-building network for building automation, BMS, fire, security & other operations

# In-building distributed antenna systems (DAS) – a repeater system

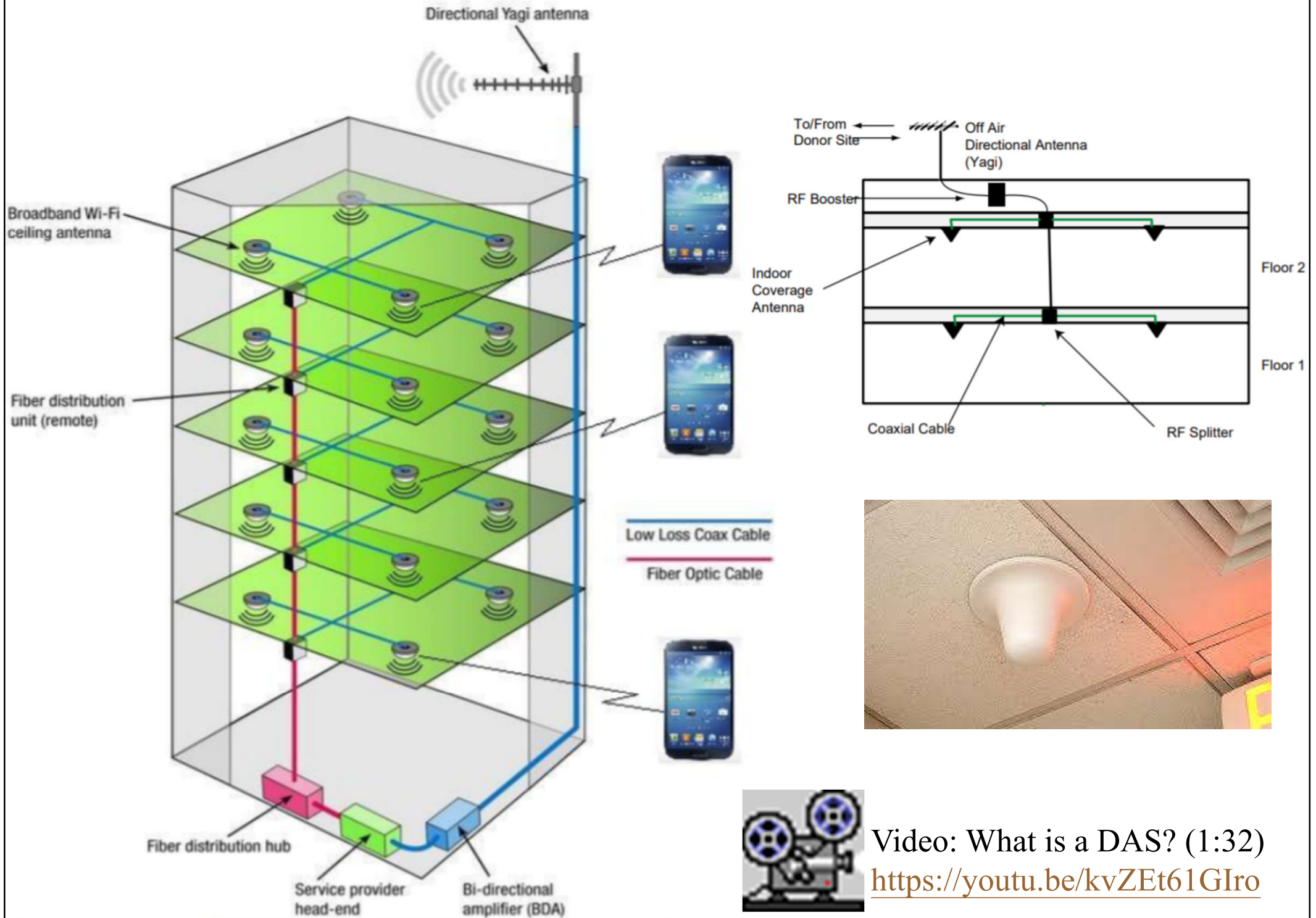



A single telecom closet serves 6 radios on this floor with 6 wiring zones

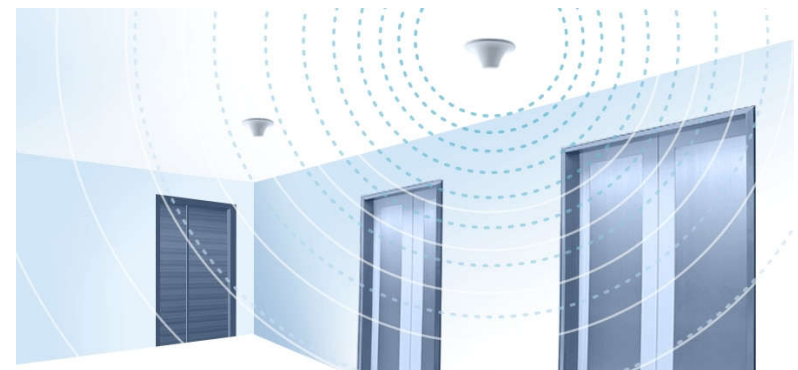
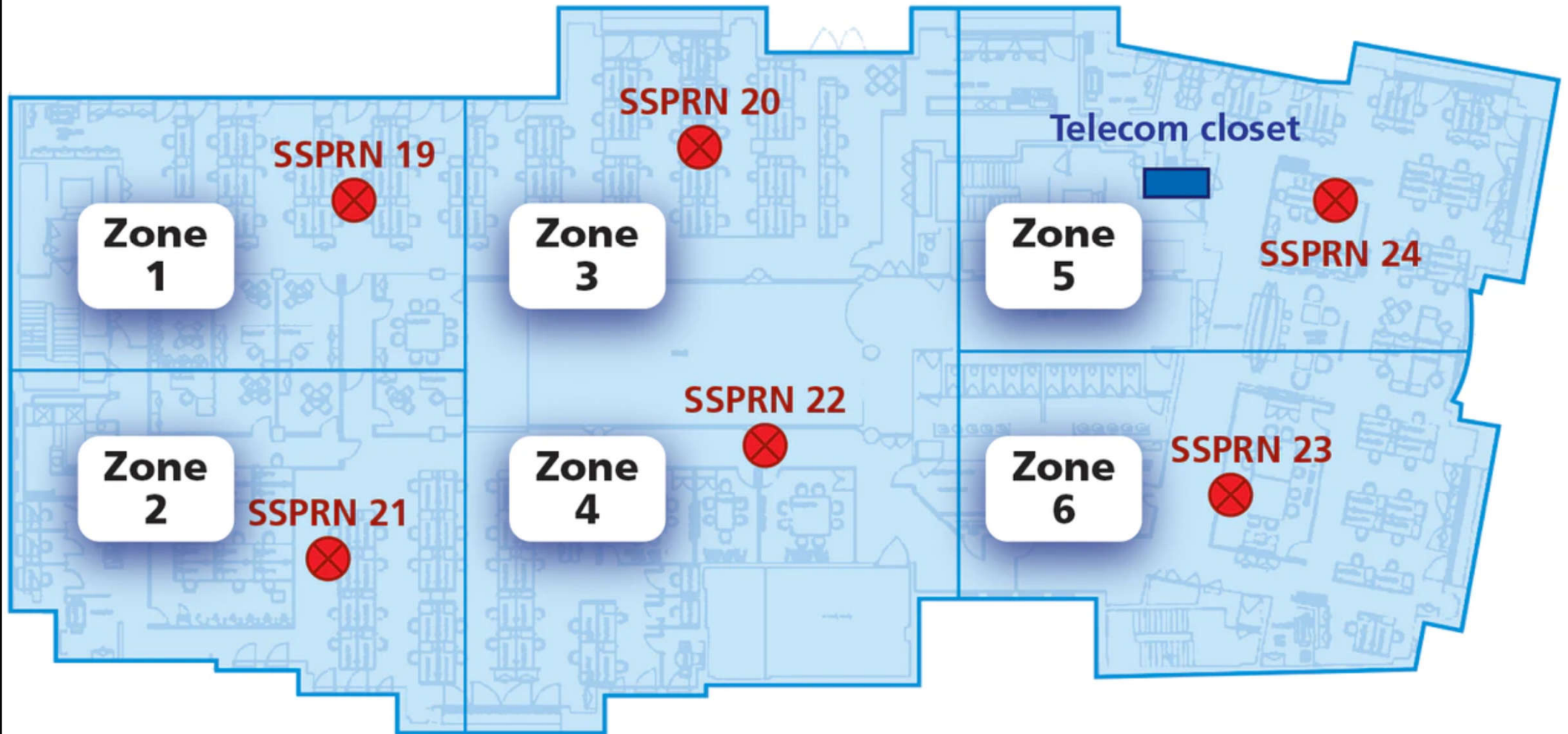

(Source: <https://www.cablinginstall.com/design-install/cabling-installation/article/14036591/corning-cabling-futureready-commercial-office-buildings>)



# In-building wireless systems

- System design options:

- RF (radio frequency) source



- Antenna/Repeater – brings in RF from the outdoor cellular network
    - Carrier installed base transceiver station provides dedicated RF

- Passive distributed antenna systems

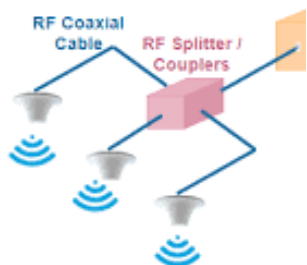

- RF is distributed over coax cables to each antenna from an RF source (repeater or base station)
    - Coax cable losses limit their effectiveness in large buildings for higher frequency transmissions

# In-building wireless systems



- System design options: (cont'd)

- Active distributed antenna systems

- Fiber-optic cabling backbone overcomes the transmission losses that occur w/ coax-based system
    - Electric components convert and amplify signals to RF by the antenna (preferred for medium to large buildings)

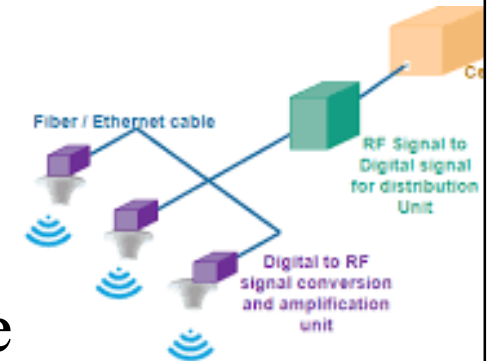

- Distributed radios (small cells)

- Consist of small cellular radios, called picocells & femtocells to create an internal cellular network
    - Do not rely on the macro network for switching & hand-offs; only wireless carriers can provide this



# Example of passive distributed antenna system

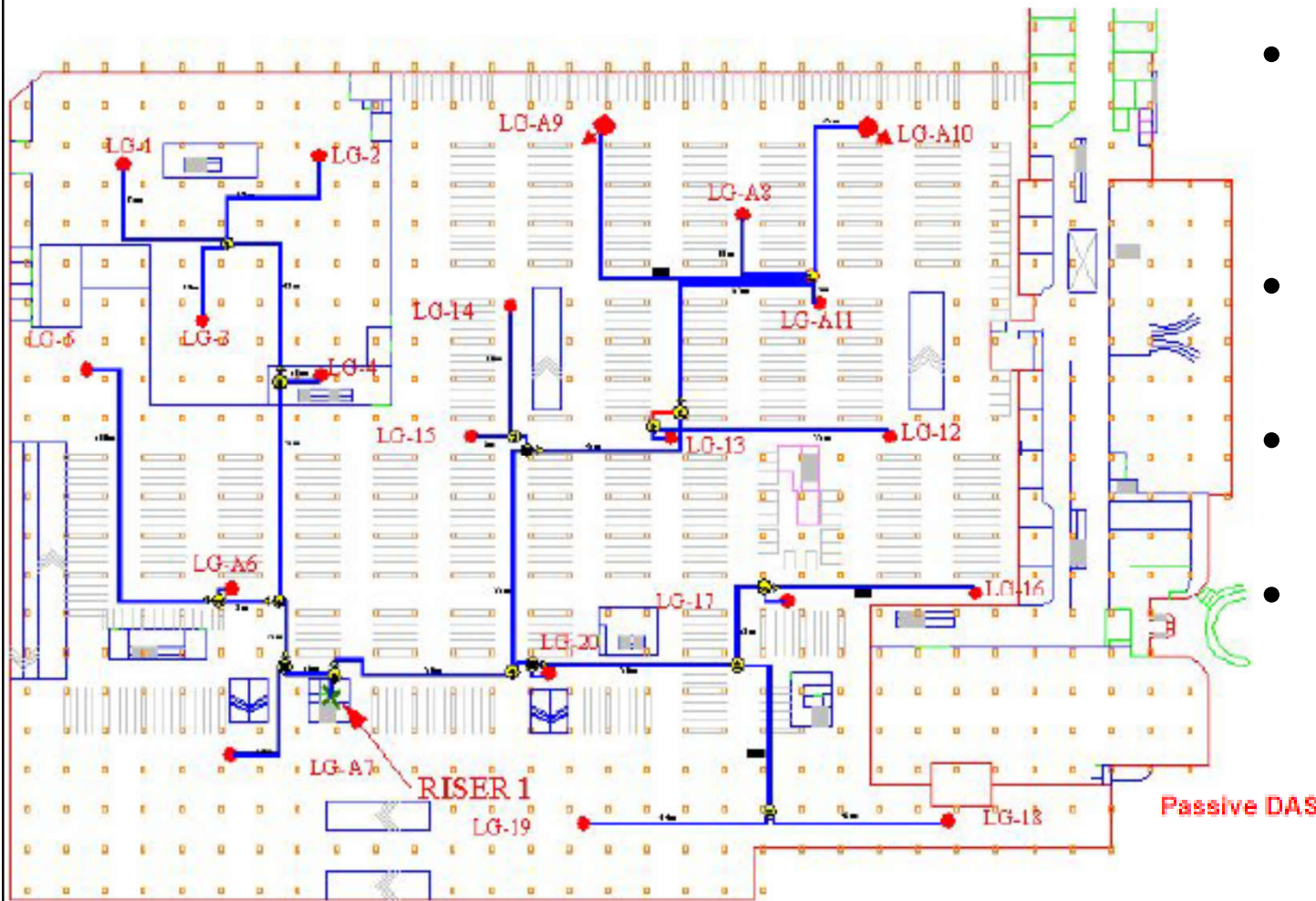

- Essentially a “sprinkler system” for cell phone signals
- Distribution via large coaxial cables
- Losses through the cable limit the size
- New, higher frequency bands have high loss

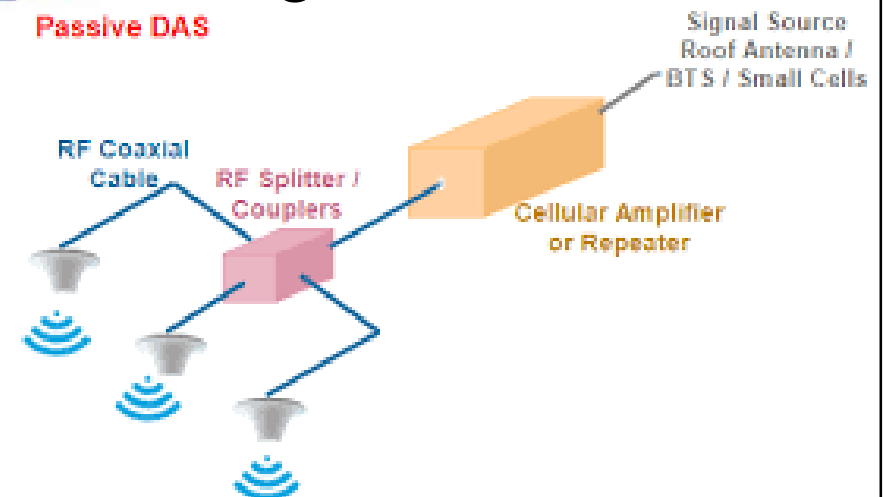

# Example of active distributed antenna system

- LAN/WLAN-like topology
- Standard structured cabling – fibre optic and CAT5 or CATV cabling
- Less disruptive install
- Amplifiers at the antenna point means zero “loss”
- Significant cost and performance advantages in medium and large buildings
- Excellent performance regardless of frequency

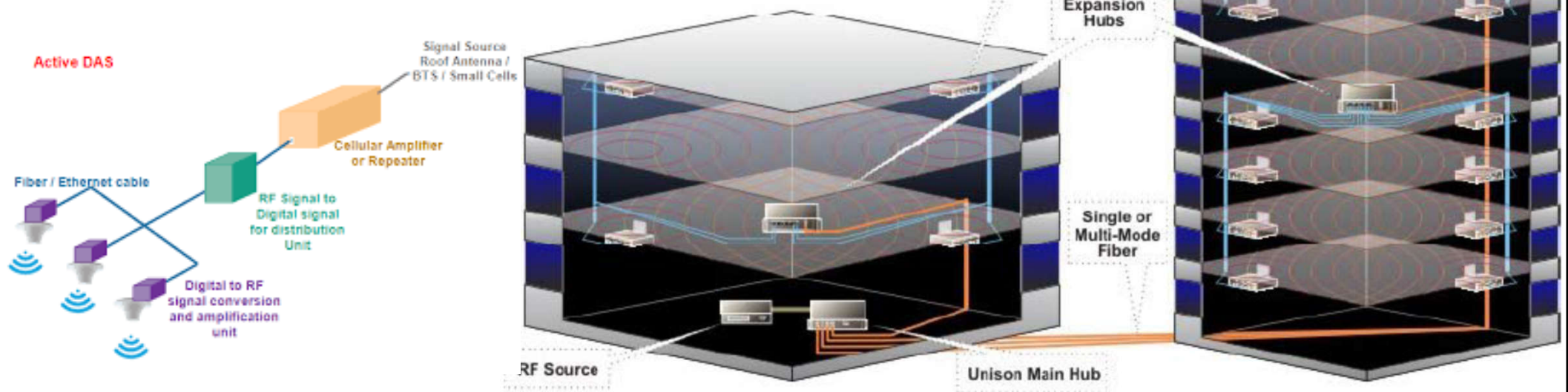



# In-building wireless systems

- In-building wireless (IBW) implementation
  - Budgetary design – usually based on floor plans
    - Determine which areas of the building require coverage (entire building, public areas, parking levels, etc.)
    - Determine the building's construction materials
    - Determine capacity requirements
  - Site survey
    - Confirm RF propagation, determine locations for equipment, confirm antenna locations, measure interference thresholds, confirm cable routes and lengths, power, security

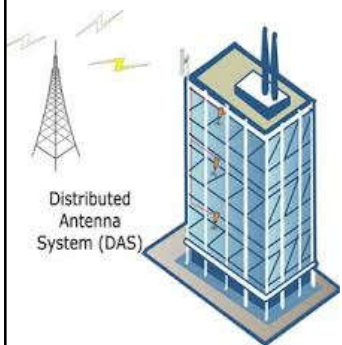



# Further Reading

- Placing Electrical Systems and Communications Systems in Buildings [US GSA]
  - <https://www.gsa.gov/node/82713>
- Structured cabling - Wikipedia  
[http://en.wikipedia.org/wiki/Structured\\_cabling](http://en.wikipedia.org/wiki/Structured_cabling)
- Structured Cabling Solutions  
<https://datalinetechnologies.com/structured-cabling-solutions/>
- In-Building Cellular Enhancement System - Wikipedia  
[https://en.wikipedia.org/wiki/In-Building\\_Cellular\\_Enhancement\\_System](https://en.wikipedia.org/wiki/In-Building_Cellular_Enhancement_System)

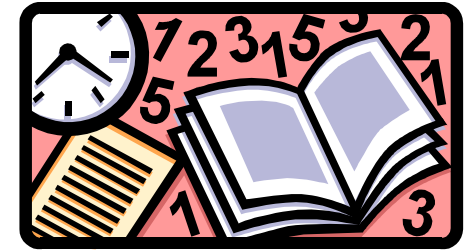

# References

- APP-84 Access Facilities for Telecommunications and Broadcasting Services <https://www.bd.gov.hk/doc/en/resources/codes-and-references/practice-notes-and-circular-letters/pnap/APP/APP084.pdf>
- CA, 2012. Code of Practice for the Installation and Maintenance of In-Building Telecommunications Systems and In-building Access by Telecommunications Network Operators, Communications Authority (CA), Hong Kong. <https://www.coms-auth.hk/filemanager/statement/en/upload/105/cop201202e.pdf>
- CA, 2012. Code of Practice for the Provision of Access Facilities in Buildings for the Supply of Telecommunications and Broadcasting Services, Communications Authority (CA), Hong Kong. <https://www.coms-auth.hk/filemanager/statement/en/upload/104/cop201201e.pdf>
- CIBSE, 1992. *Information Technology and Buildings*, Applications Manual 7, Chartered Institution of Building Services Engineers, London.