

Lighting Systems & Components

Ir Dr. Sam C. M. Hui

E-mail: sam.cmhui@gmail.com

<http://ibse.hk/cmhui/>

Contents



- Lighting applications
- Control gear
- Lighting controls
- Wired & wireless systems
- Smart lighting

Lighting applications



- Common applications
 - Indoor lighting
 - Residences, offices, classrooms, health care, retails
 - Outdoor lighting
 - Street & stadium lighting, architectural floodlighting
- Special applications
 - Lighting for art, entertainment, emergency, safety
 - Lighting for transport, parking, manufacturing
 - Digital signage (e.g. advertisements, exit signs)

Three basic types of lighting

AMBIENT

Used to provide even, overall light to a room

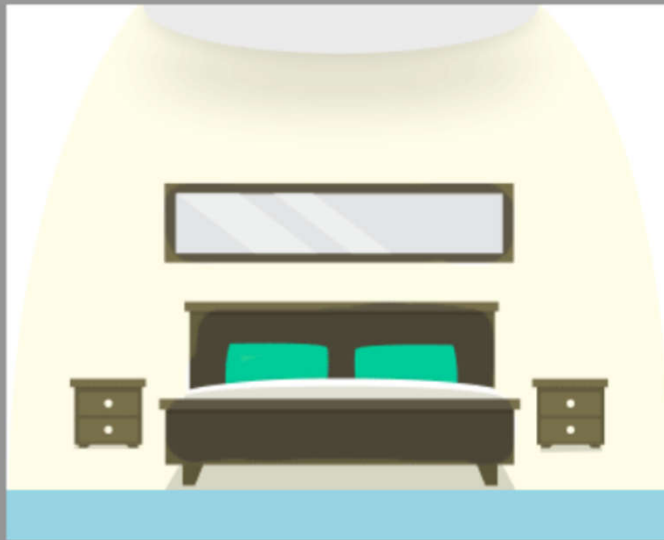

ACCENT

Used to create different focal points

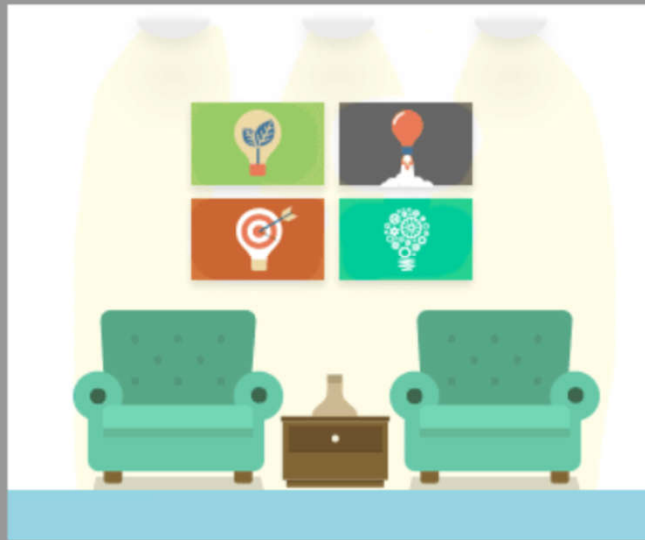

TASK

Used when performing specific tasks

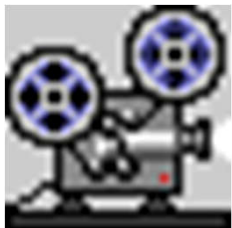

Video: Lighting Tips at a Glance (1:35) https://youtu.be/yR_Pa-a0W6k

Lighting applications



- Four types of lighting methods
 - General ambient indoor lighting
 - Ambient outdoor lighting
 - Task lighting
 - Accent lighting
- Components of lighting systems
 - Lighting hardware & auxiliary equipment
 - Environmental components (architectural & interior design, decoration)



Types of fixtures for different lighting methods

General ambient indoor lighting:

- Chandelier (水晶吊燈)
- Ceiling mounted fixture
- Wall-mounted fixture
- Traditional recessed fixtures and / or LED downlights
- Track light
- Floor lamp
- Table lamp

Ambient outdoor lighting:

- Spotlight
- Hanging fixture
- Garage and canopy lighting
- Post lantern
- Wall lighting
- Recessed fixture used in overhanging structures

Task lighting:

- Directional gimbal recessed fixture or downlight
- Pendant lighting
- Slim line bar and undercabinet
- Tape and extrusion
- Portable or desk lamp

Accent lighting:

- Track light
- Slim line bar and undercabinet
- Tape and extrusion
- Directional recessed fixture or downlight
- Wall-mounted fixtures

Examples of bedroom lighting fixtures



Flush-mount ceiling fixtures



Semi-flush-mount ceiling fixtures

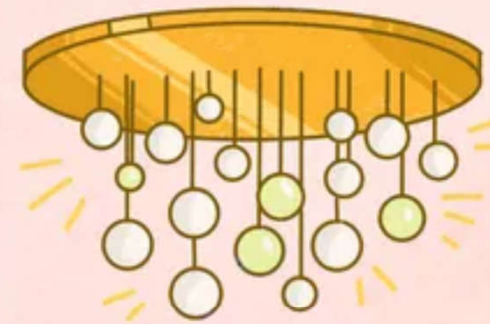

Chandeliers

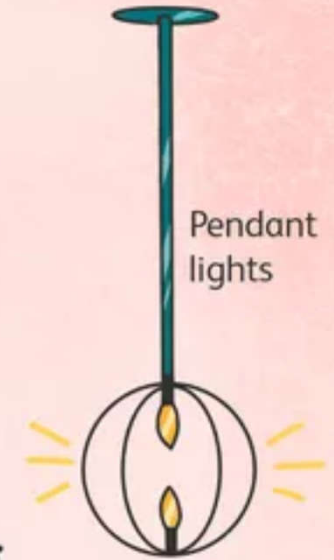

Pendant lights



Floor lamps



Bedside lamps

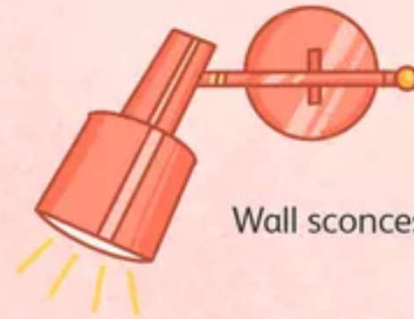

Wall sconces



Recessed lighting

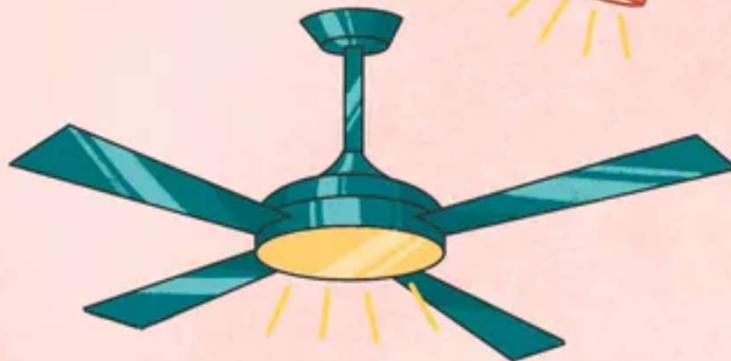

Ceiling fans

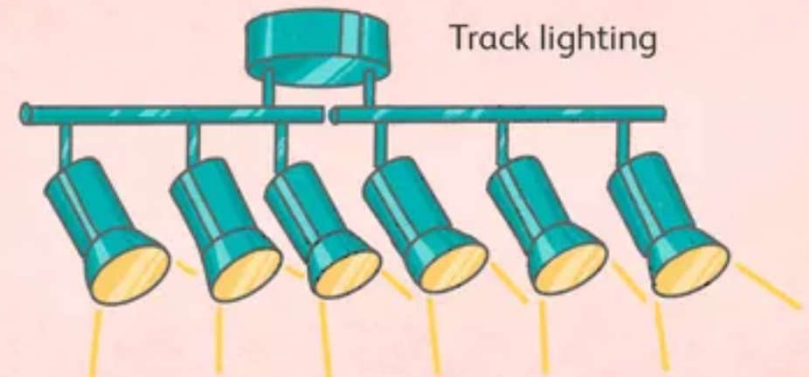

Track lighting

Options for Bedroom Lighting



Cove-mounted Uplighting

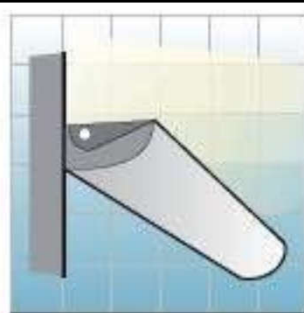

Wall-mounted Uplighting

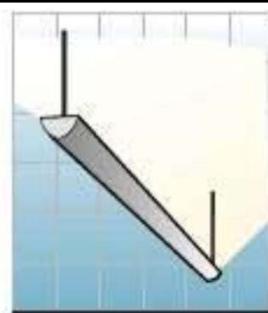

Suspended Linear Fluorescent Luminaire



Recessed Round Downlight



Open HID High-bay (Metal Reflector) Luminaire



Recessed Round Wall-washers



Decorative Pendant Downward Light



Portable Task Lighting



Track Lighting (Metal Halide)



Track Lighting (Incandescent)



Functional Wall Sconce

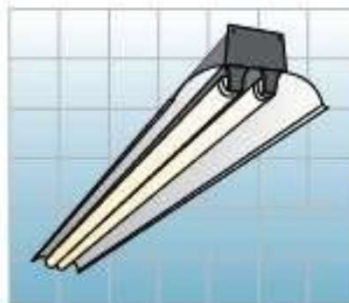

Open Fluorescent Luminaire, Ref. Industrial



Portable Torchiere Uplight



Task Lighting, Fixed and Furniture Integrated

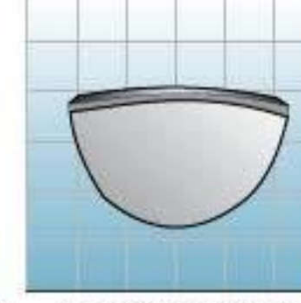

Decorative Wall Sconce



Open Fluorescent Luminaire, Striplight

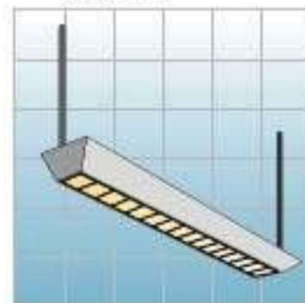

Suspended Direct-Indirect Fluorescent Luminaire (mostly up)



Open HID High-bay Luminaire, Glass or Plastic Reflector



Typical Compact Fluorescent Task Light

Different types of lighting fixtures

Lighting applications



- Components of lighting systems

- Lighting components

- Power source
 - Power controller: switching/dimming
 - Power regulators: ballasts
 - Light source: lamp
 - Optical control: luminaire or fixture

- Environmental components

- Room finishes: reflectances & texture
 - Spatial envelope: room boundaries
 - Fenestrations: windows & skylights

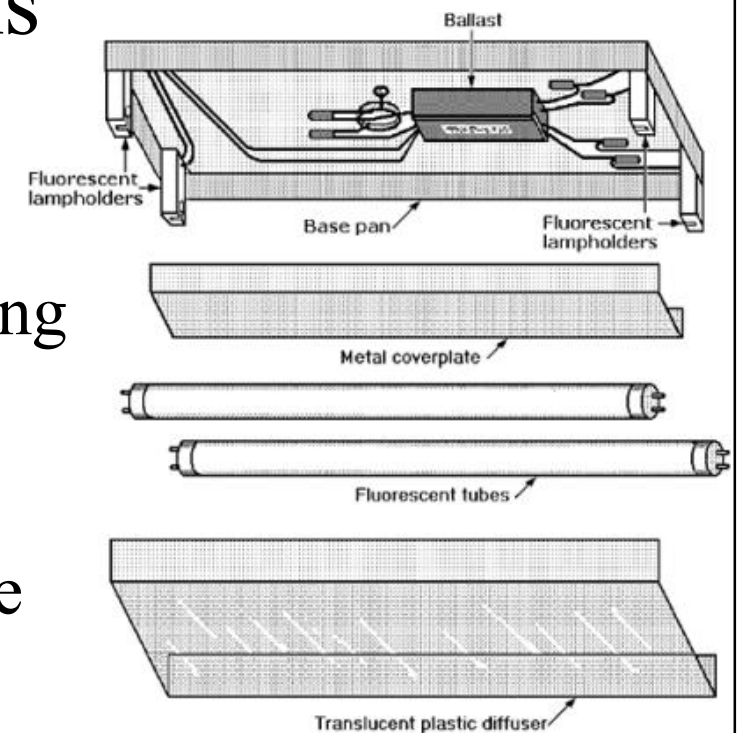

Light fixture (luminaire) components

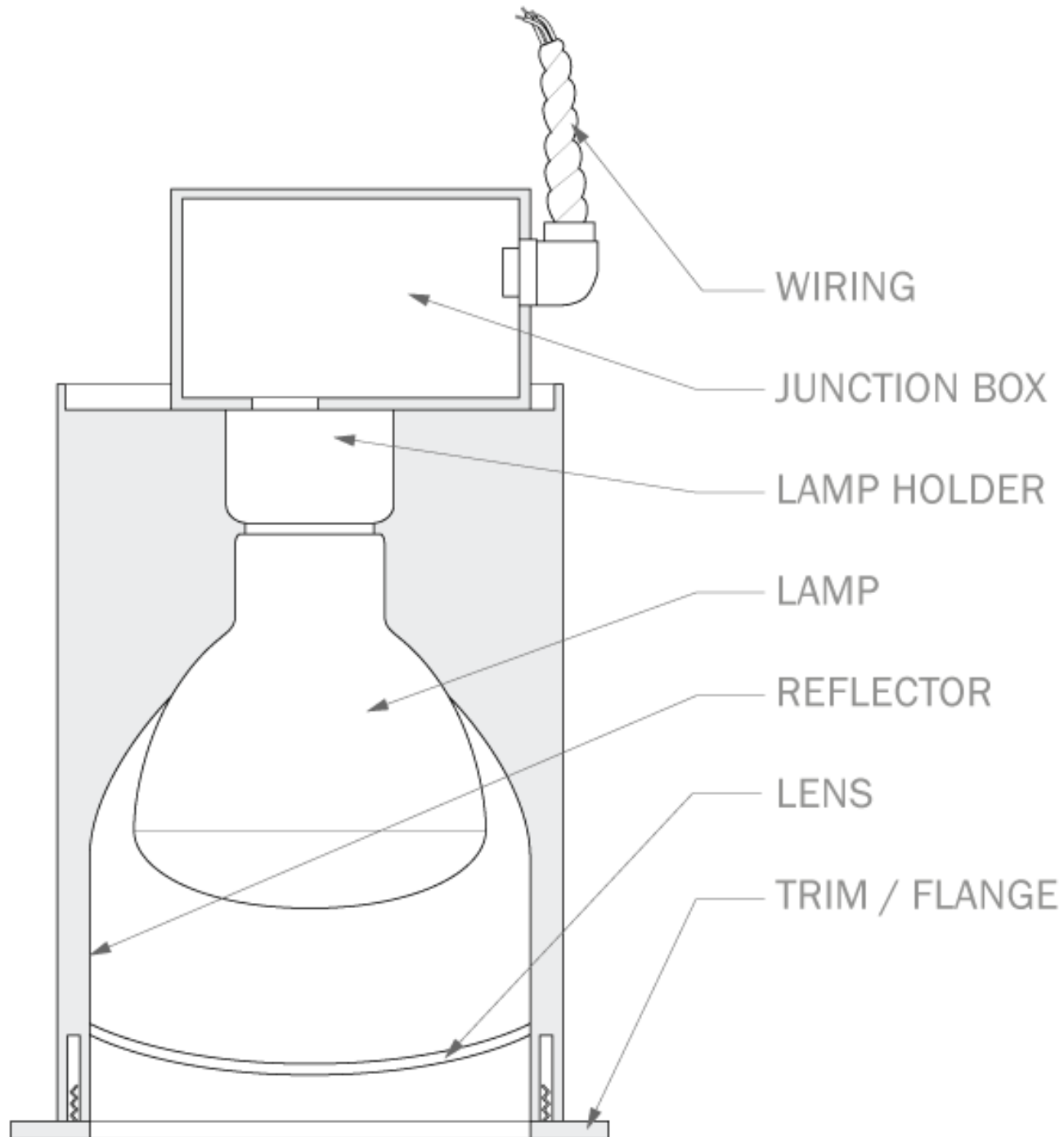

Lamp receptors 燈座



Basic components of luminaire 燈具的基本組成部分

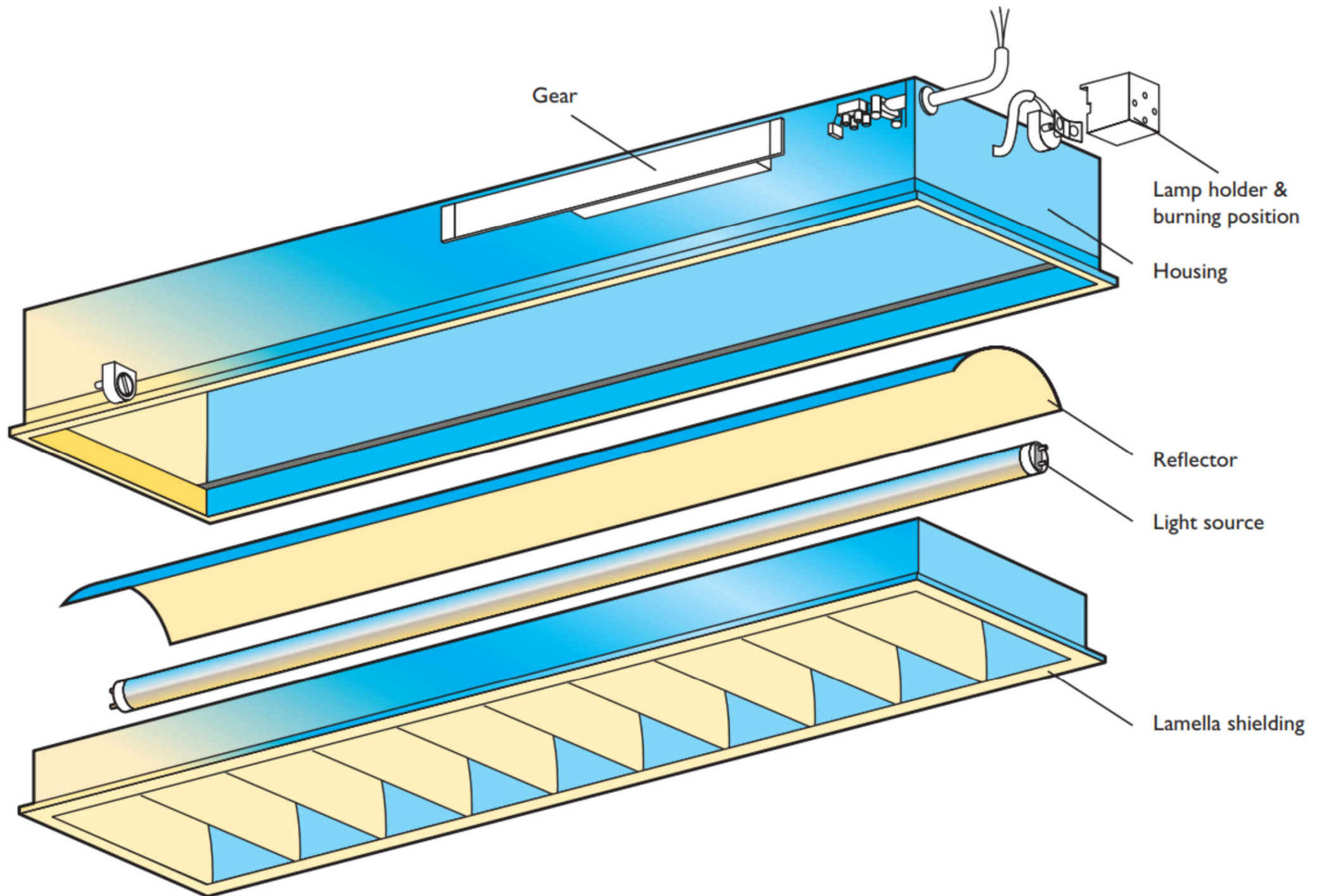

Control gear



- Many lamps & light sources require some form of control gear (often referred to as ballasts, chokes, drivers, igniter or inductive/electronic transformers) to enable the correct start-up, control & operation
- Some types also incorporate a connection for a form of communication to enable the lamp or light source to be controlled remotely and/or provide luminaire status feedback

Control gear



- Lamps & light sources requiring control gear:
 - Incandescent lamps (other than mains electricity rated)
 - Fluorescent lamps
 - High intensity discharge lamps
 - Other discharge lamps
 - LED/OLED light sources
 - Emergency luminaires
- Incorporated within the luminaire, separate or remote; may also supply multiple luminaires



Transformer for low voltage incandescent lamps

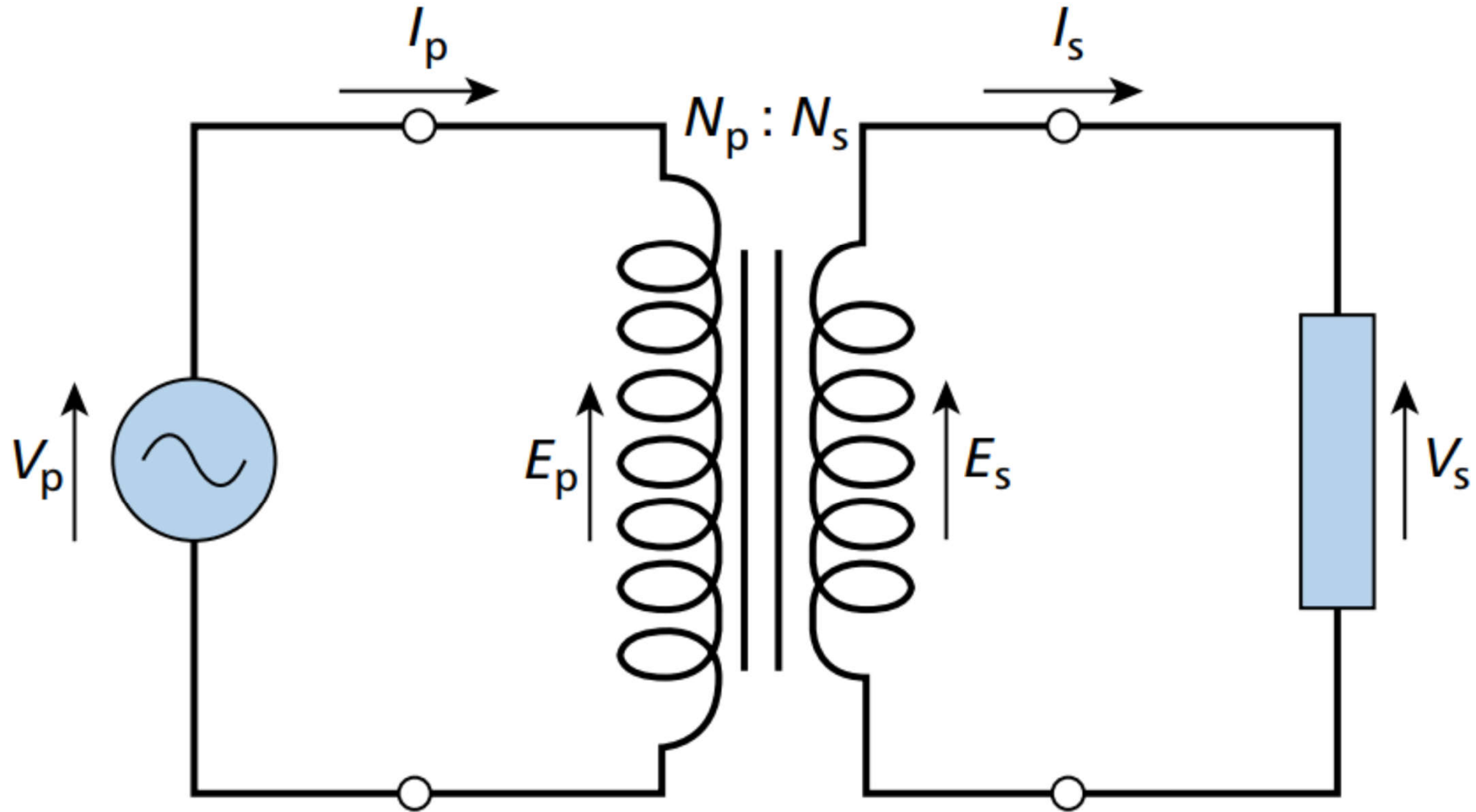

$$\frac{V_p}{V_s} = \frac{I_s}{I_p} = \frac{N_p}{N_s}$$

Fluorescent lamps & starters 螢光管和起動器

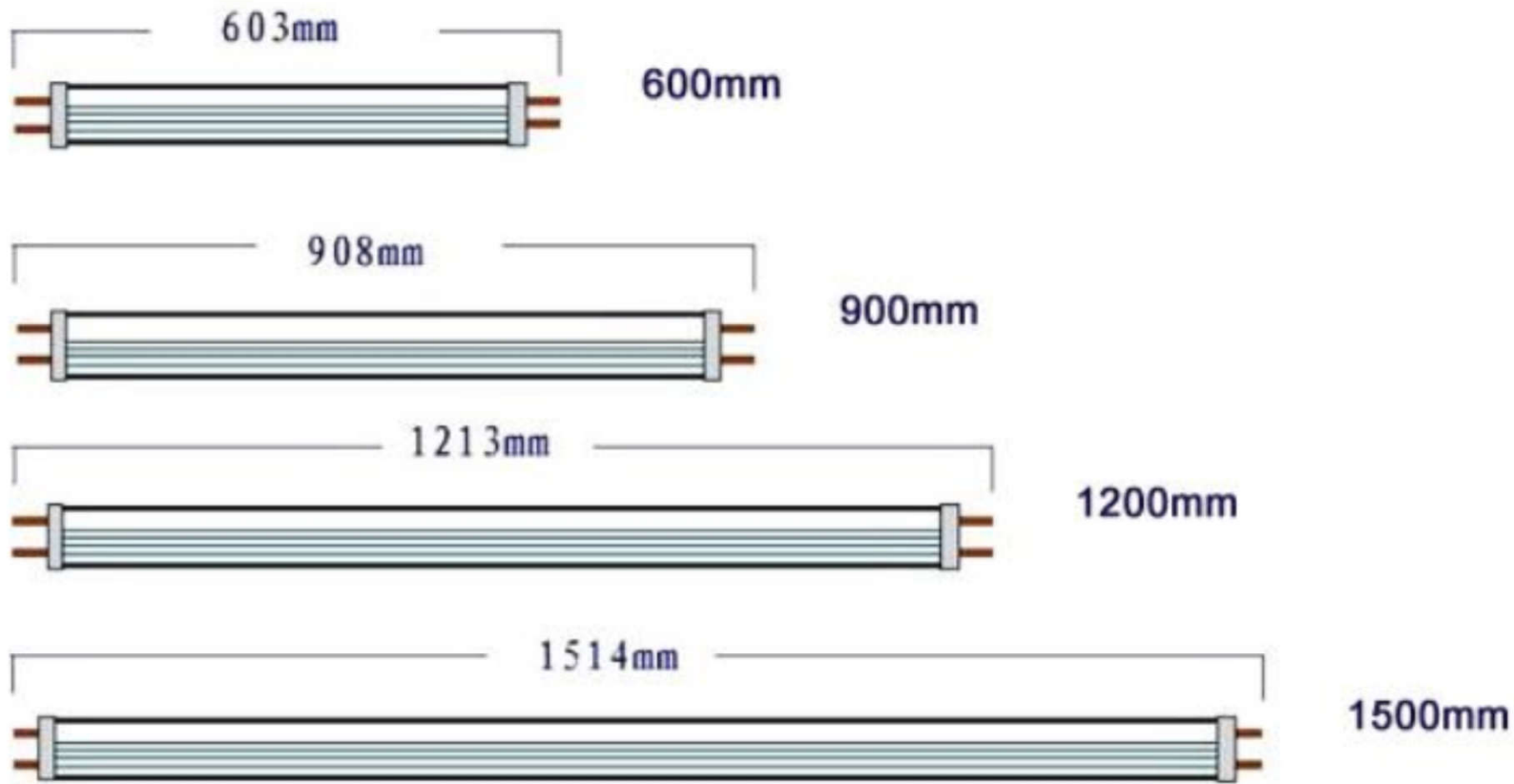

Glow Type Fluorescent Lamp Circuit (啟輝式光管電路):

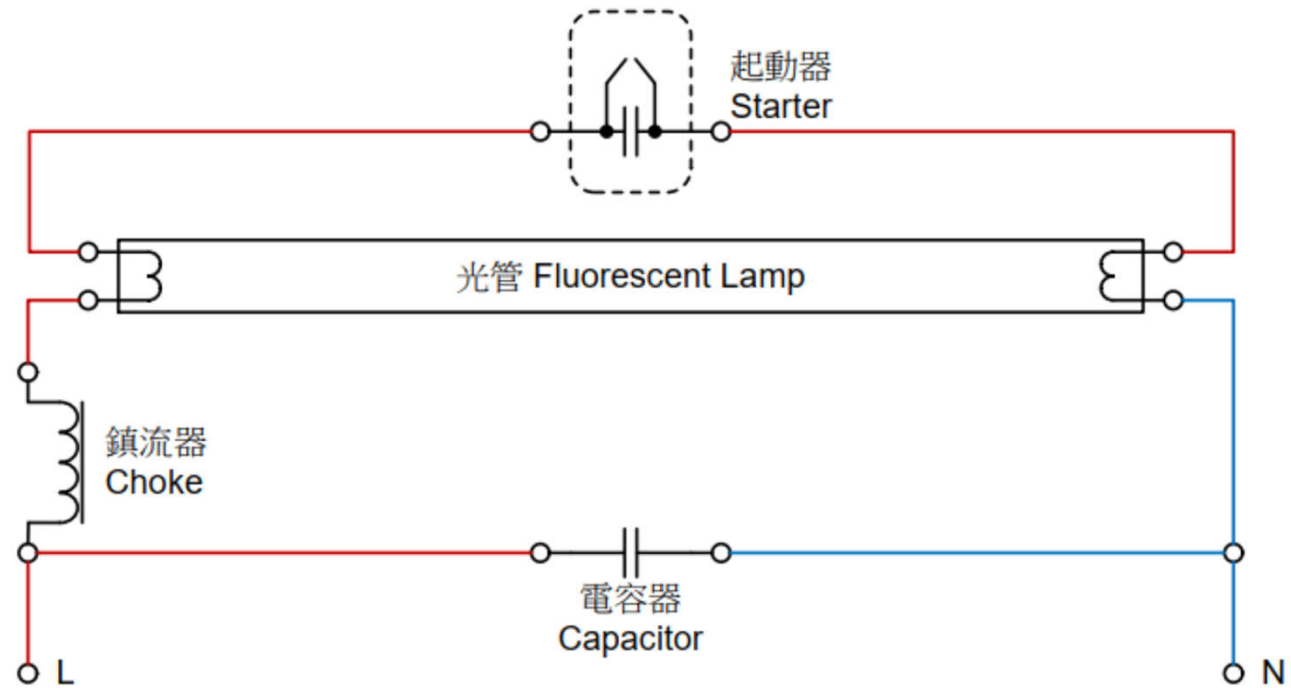

Semi Resonant Start Type Fluorescent Lamp Circuit (半諧振式起動光管電路):

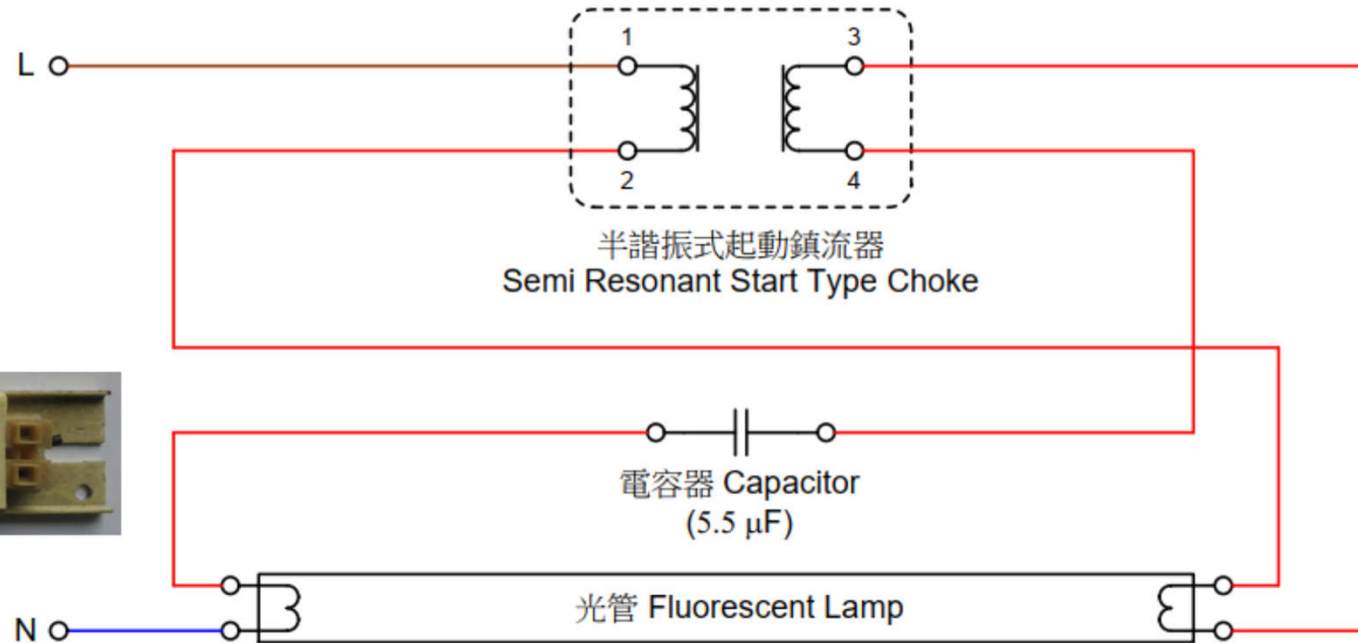
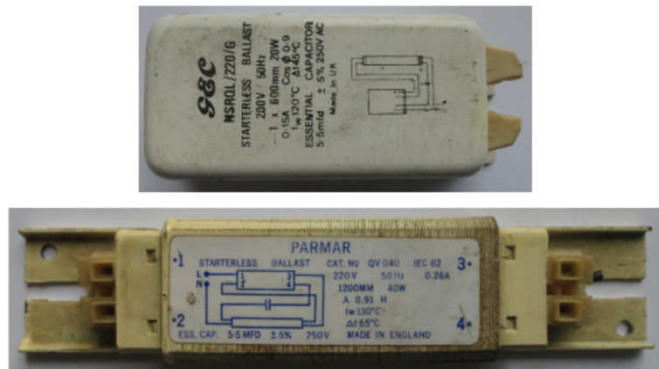

Quick Start Fluorescent Lamp Circuit (快速起動光管電路):

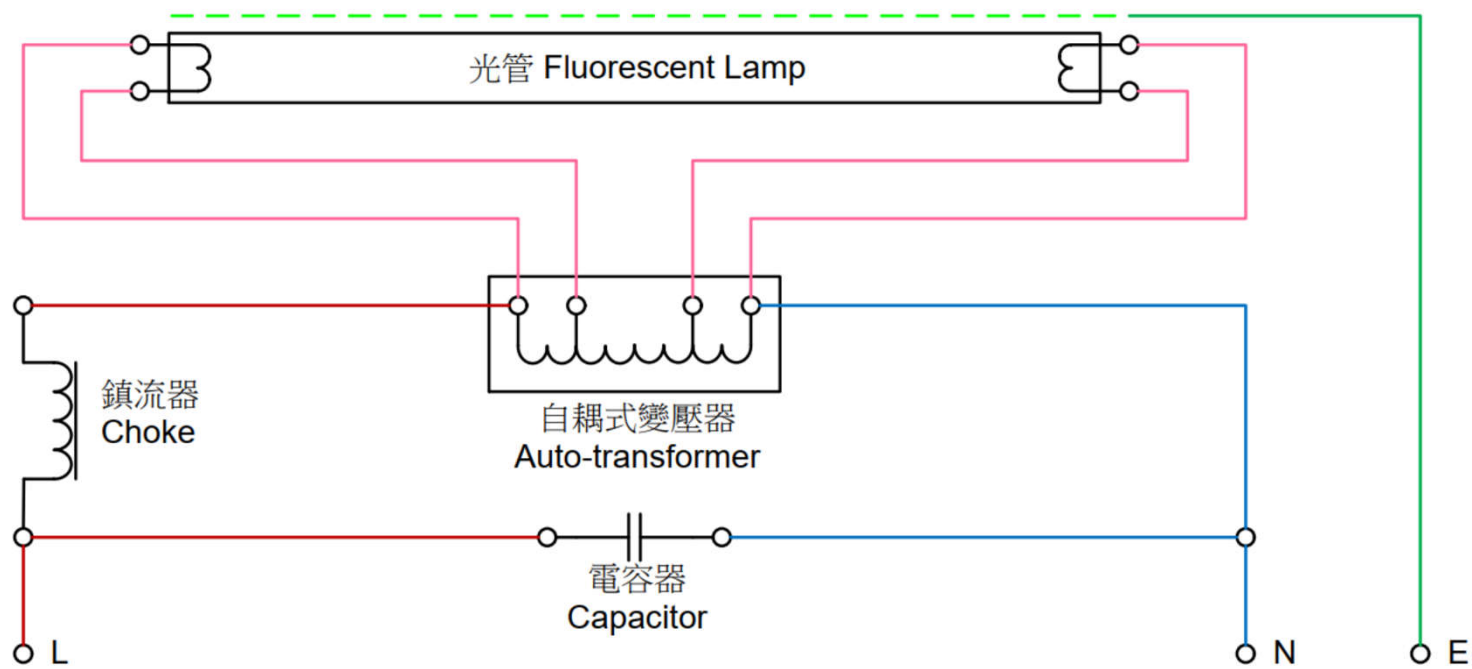

Electronic Choke Fluorescent Lamp Circuit (電子鎮流器光管電路):

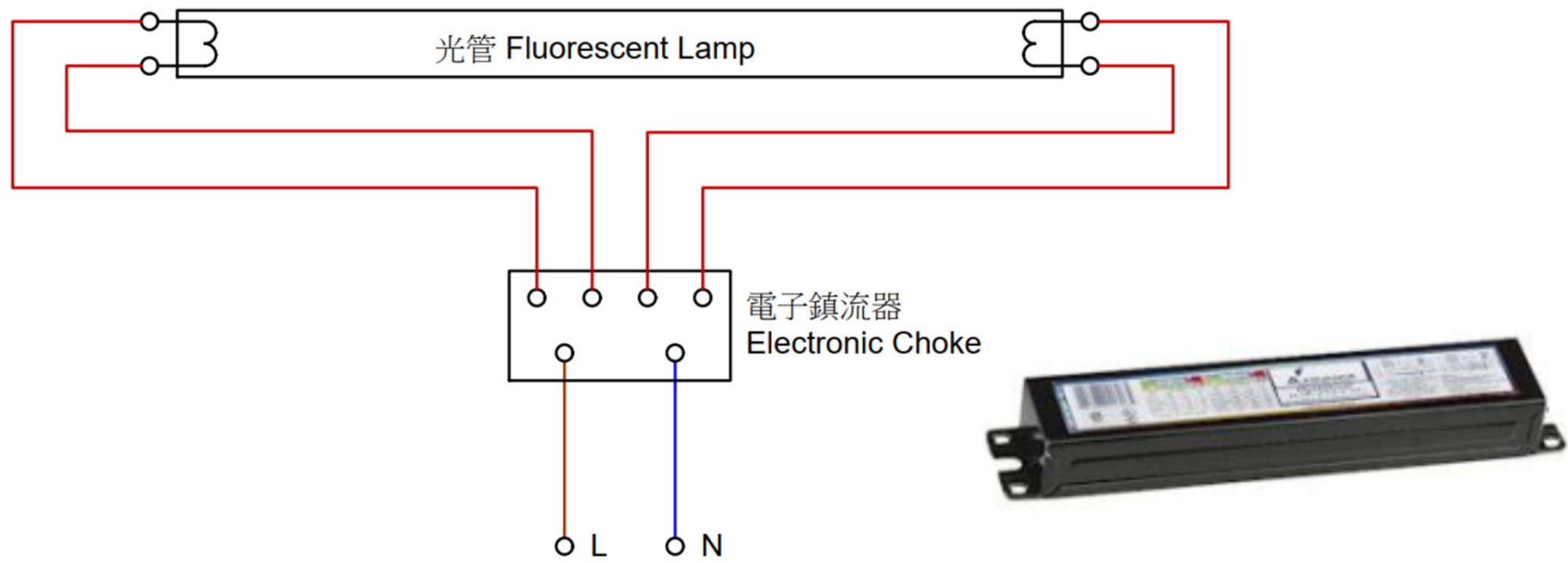

Circuit diagram of an electronic ballast for two fluorescent lamps

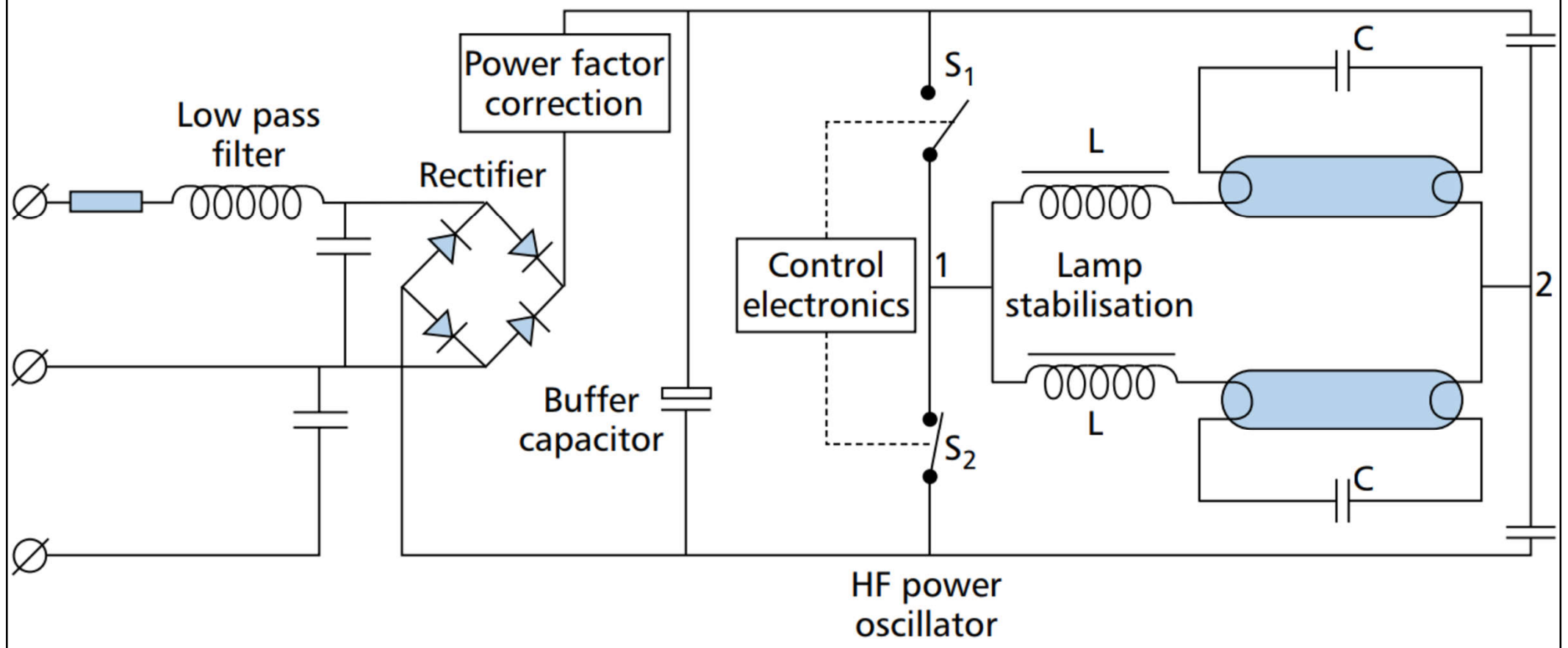

HF power oscillator

Wiring Diagram

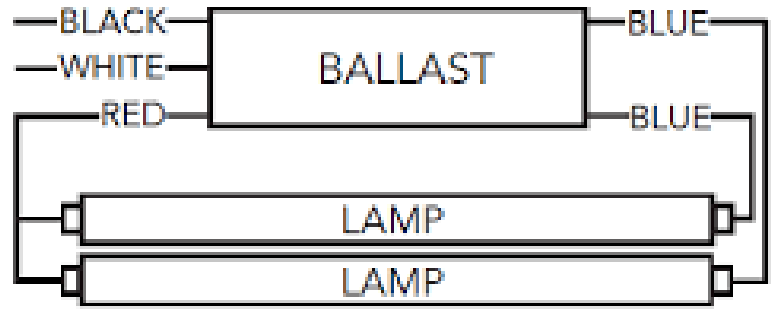

For 1-lamp operation cap one blue lead



(Source: The SLL Lighting Handbook 2018)

Control gear for discharge lamps

Igniter circuits: (a) semi-parallel, (b) superimposed

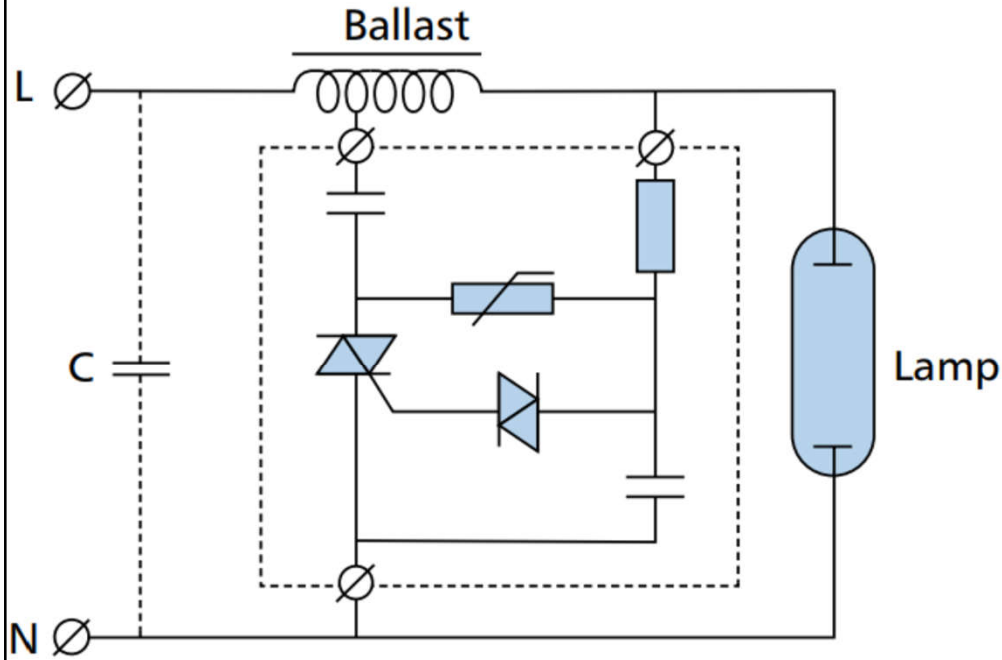

(a)

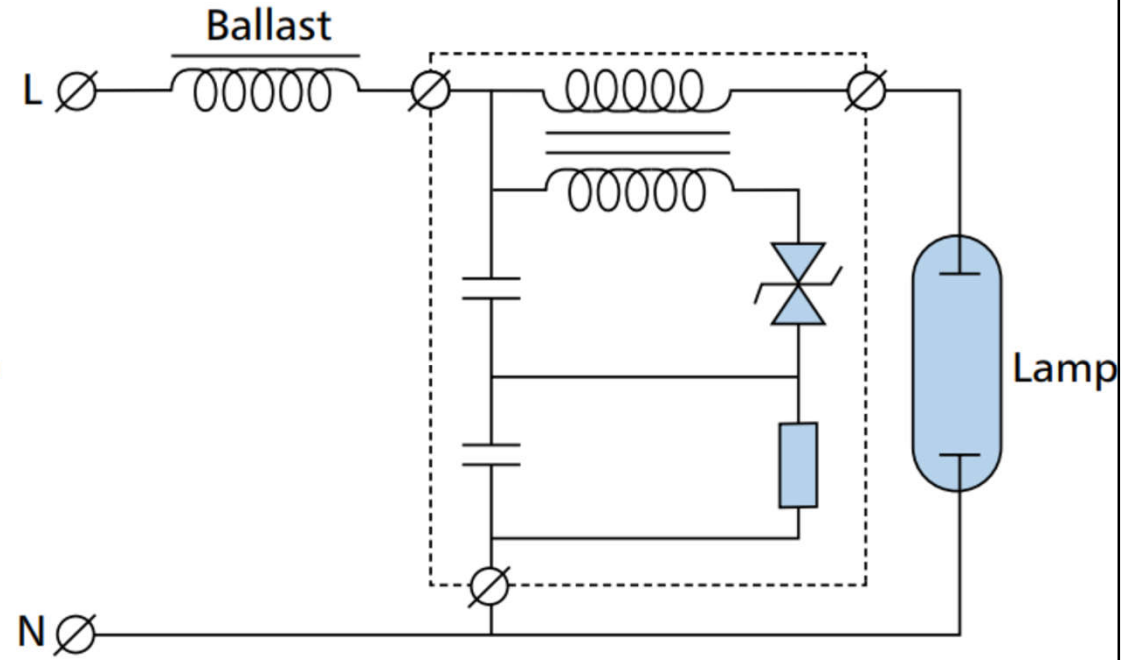

(b)



Control gear



- Control gear or drivers for LED/OLED lights:
 - Constant current & constant voltage drivers
 - Galvanic insulated & non-insulated drivers
 - Indoor & outdoor drivers
 - Dimmable & non-dimmable drivers
 - Single-channel & multi-channel drivers
 - Built-in & independent (remote) drivers
 - Standard & industrial grade drivers
 - Linear & compact shaped drivers



Control gear for emergency lighting applications:
Single driver with automatic control & remote monitoring;
only channel 4 remains in operation during emergency conditions

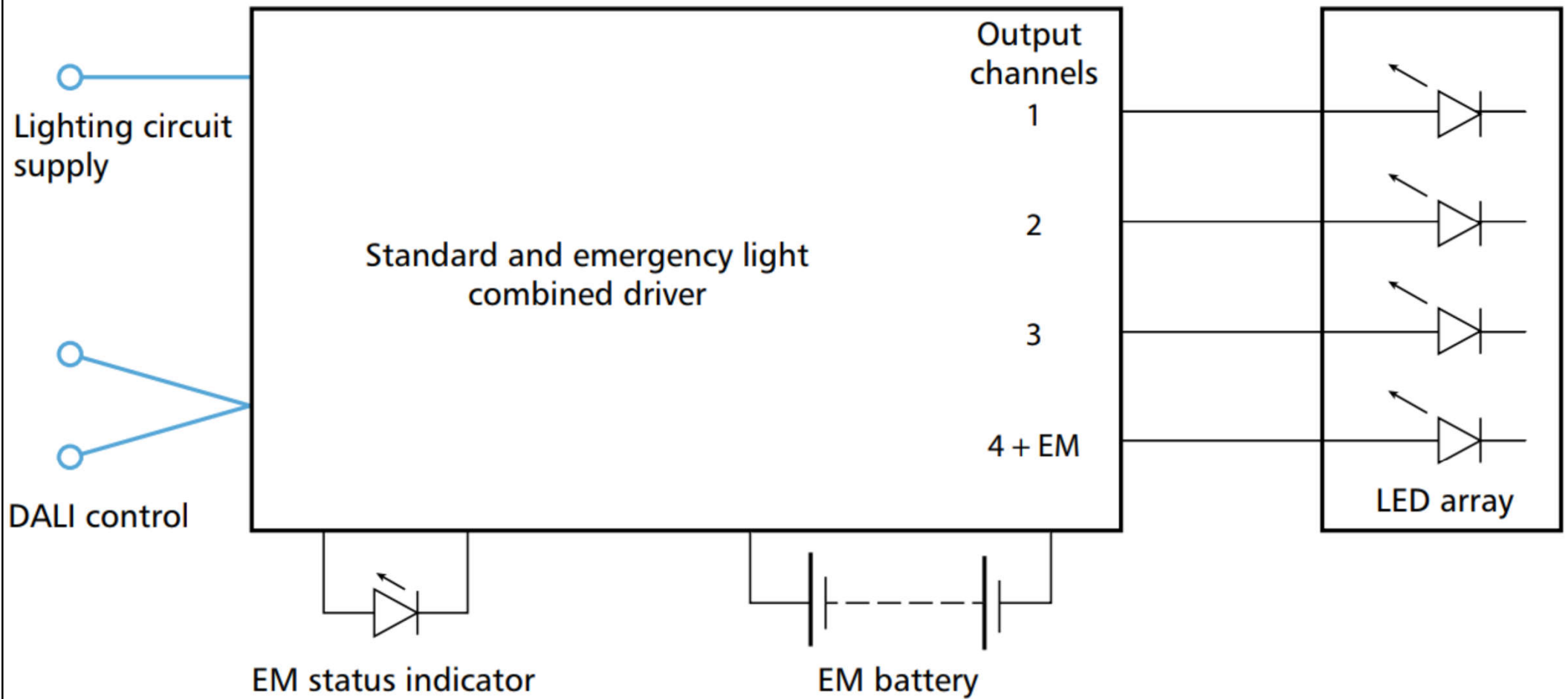

Control gear



Video: What is a ballast? (4:48) <https://youtu.be/4IbjTFDZXBw>

- Ballasts (e.g. electromagnetic & electronic)
 - For operation of gas discharge lamps (e.g. fluorescent, HID) & LED lamps
 - Provide several functions:
 - 1. Deliver proper voltage to start or ignite the lamp(s)
 - 2. Current limiting (to safely sustain operation)
 - 3. Compensate for variations in line voltage
 - 4. May offer electrode preheat, dimming or power quality adjustment
 - Consume power & reduce lumens per watt rating



Control gear



- Ballast factor (BF) (range from 0.7 to 1.2)
 - It is a measure of actual lumen output for a specific lamp-ballast system relative to the rated lumen output measured with a reference ballast under test conditions
 - Lamp wattage x number of lamps x ballast factor = Estimated total system wattage
- Ballast efficacy factor (BEF)
 - = Ballast factor (BF) x 100 / Input Watts

Control gear



- Harmonics caused by electronic ballasts
 - Switching techniques in solid-state electronics
 - Total harmonic distortion (THD)
 - Distorted wave from superimposing harmonic sine waves (multiples of the fundamental)
 - Consequences of harmonics:
 - Cause lower power factors
 - Contribute to resistive heating in wiring, insulation, etc
 - Produce overheating in transformers
 - Cause excessive current in neutral conductor

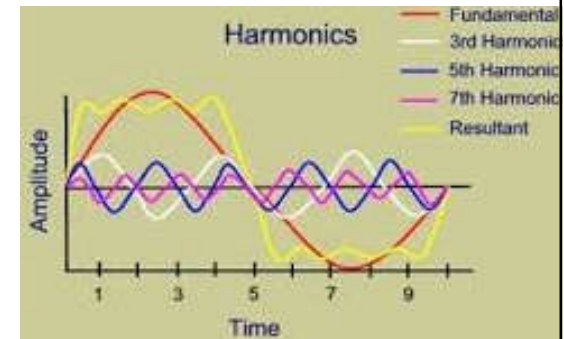

Lighting controls

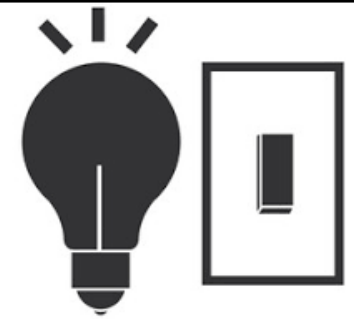

- A good lighting system design includes a good lighting controls design to enable users manually or automatically to:
 - Turn the lights ON & OFF using a switch; and/or
 - Adjust light output up & down using a dimmer
- Benefits for the owner:
 - Flexibility to satisfy user visual needs
 - Automation to reduce energy costs & improve sustainability

Benefits of good lighting controls

Visual Needs	Energy Management & Sustainability
<ul style="list-style-type: none">• Change space appearance• Facilitate different functions of the space• Alter atmosphere & mood• Reduce glare & visual discomfort conditions• Increase user satisfaction by providing users the ability to control their lighting	<ul style="list-style-type: none">• Reduce both energy demand & energy consumption• Reduces building operating costs• Comply with building energy codes• Facilitate more efficient building operation & maintenance• Provide data & information for building optimization

Overview of lighting control methods

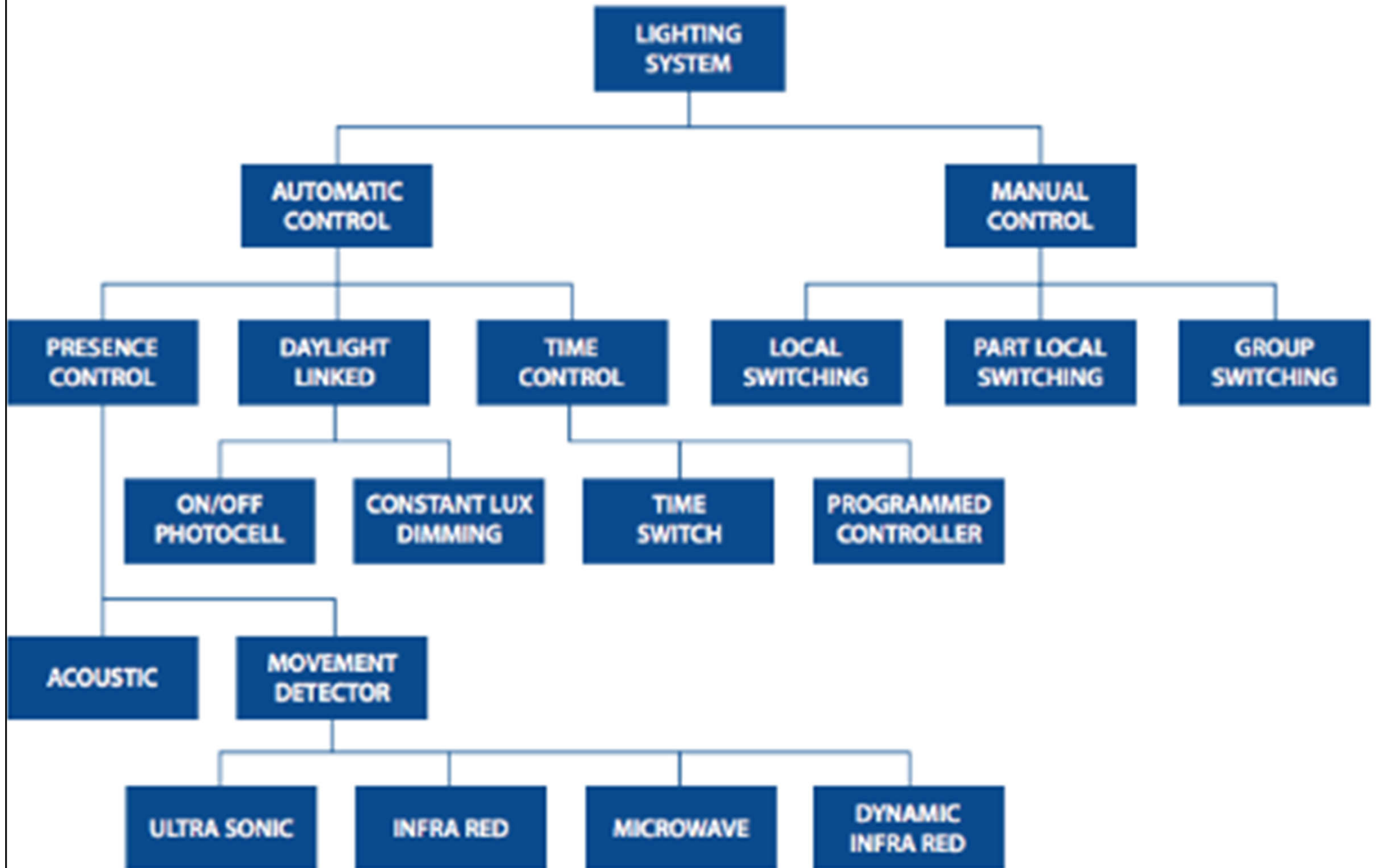

Lighting controls

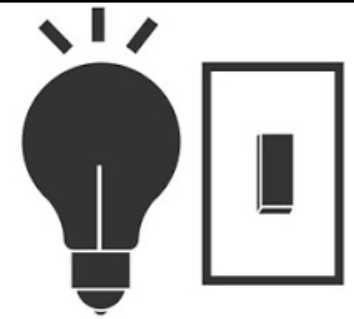

- Control strategies

- Manual control (local/group)
- Time scheduling (time-based control)
- Occupancy sensing (vacancy sensing)
- Daylight response (to reduce electric lights)
- Institutional task tuning (user preference, scene)
- Colour tuning (various effects)
- Data generation (intelligence)
- Demand response (\downarrow demand costs)

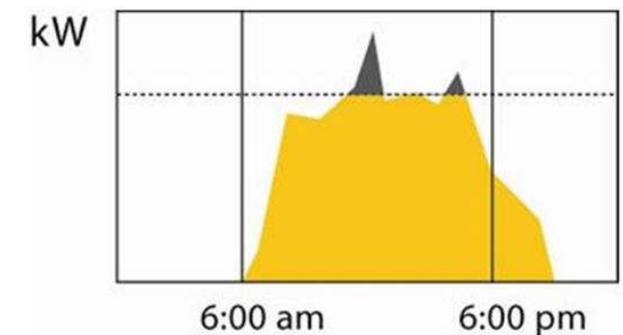
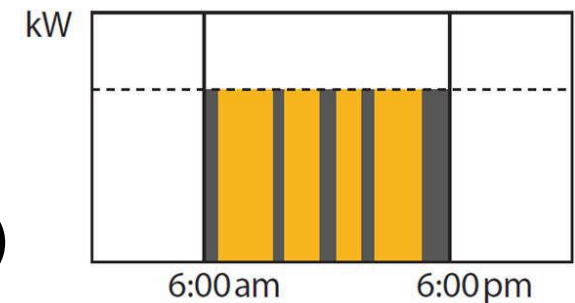

Lighting controls

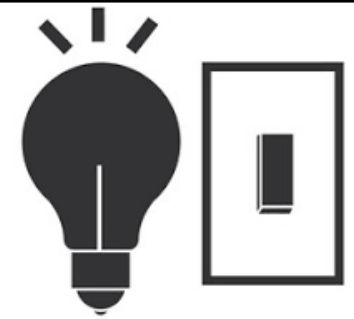

- General types of lighting controls
 - 1. Standalone devices (luminaire-based)
 - Autonomous operation of a lighting load, which may be a luminaire or luminaires installed on a switch leg
 - Standalone embedded sensors
 - 2. Room-based control systems
 - A package of lighting controllers & input devices designed for autonomous room-based operation
 - 3. Centralized building control systems
 - Programmable lighting control for entire floors, buildings or campuses

Lighting controls

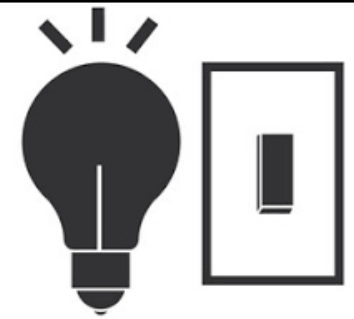

- Lighting control techniques & tools
 - Manual control (switches)
 - Timed control (timeclocks)
 - Presence detection
 - Absence detection
 - Photocells
 - Daylight linking
 - Constant illuminance adjustment
 - Dimming & regulation



Lighting controls

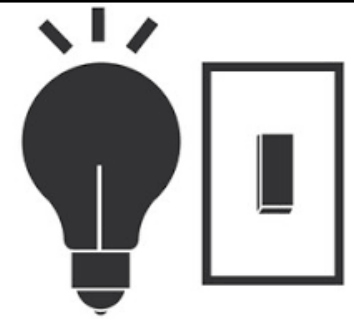

- Occupancy sensing detection
 - Passive infrared detectors
 - Microwave detectors
 - Ultrasonic detectors
- Photocells & daylight linking
 - Measure available light at a specific location
 - Switch off or dim/regulate the electric lighting
 - Can adjust for constant illuminance at working plane
- Dimming: by supply voltage or electronic

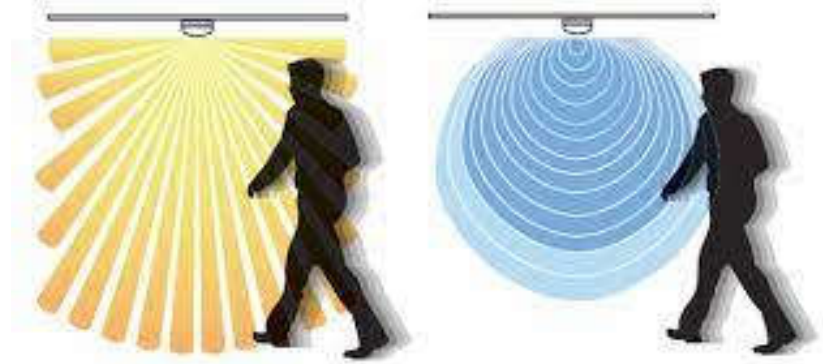

Daylight linking of luminaires from left to right



(Source: SLL, 2016. *Control of Electric Lighting*, Lighting Guide 14, Society of Light and Lighting (SLL), London.)

Lighting control for constant illuminance adjustment

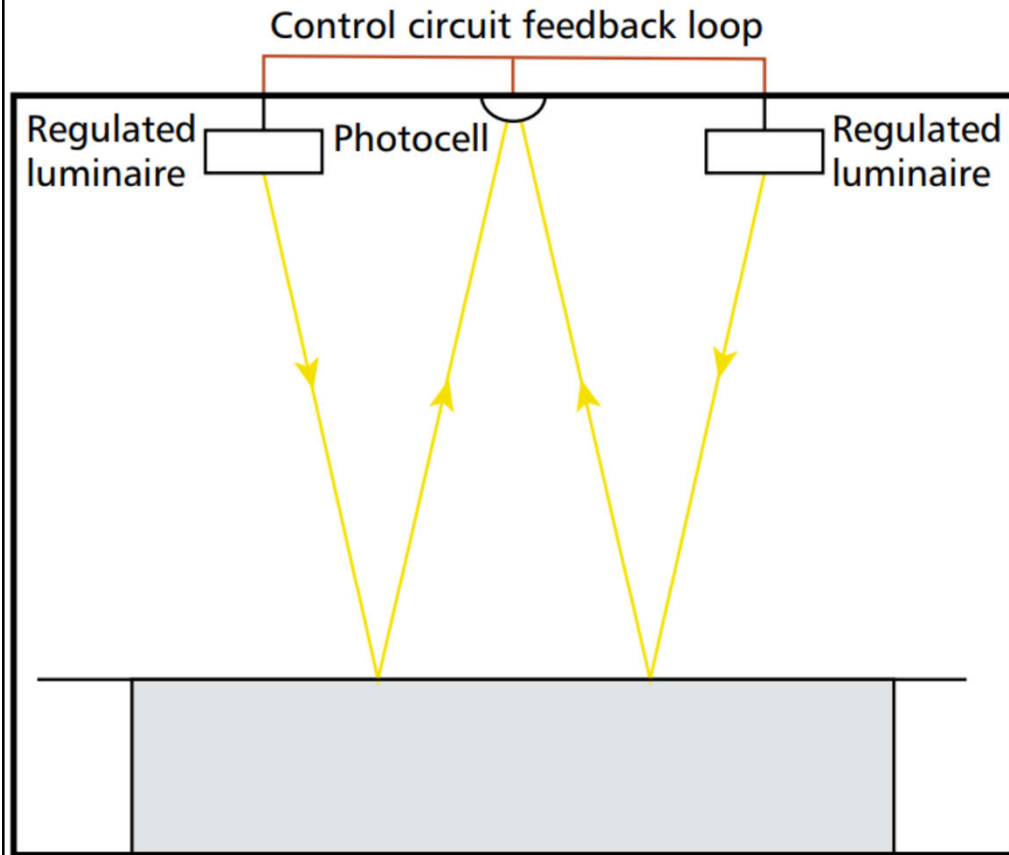

(a) A photocell is used to measure the reflected light from the working plane to adjust the light output to the required output

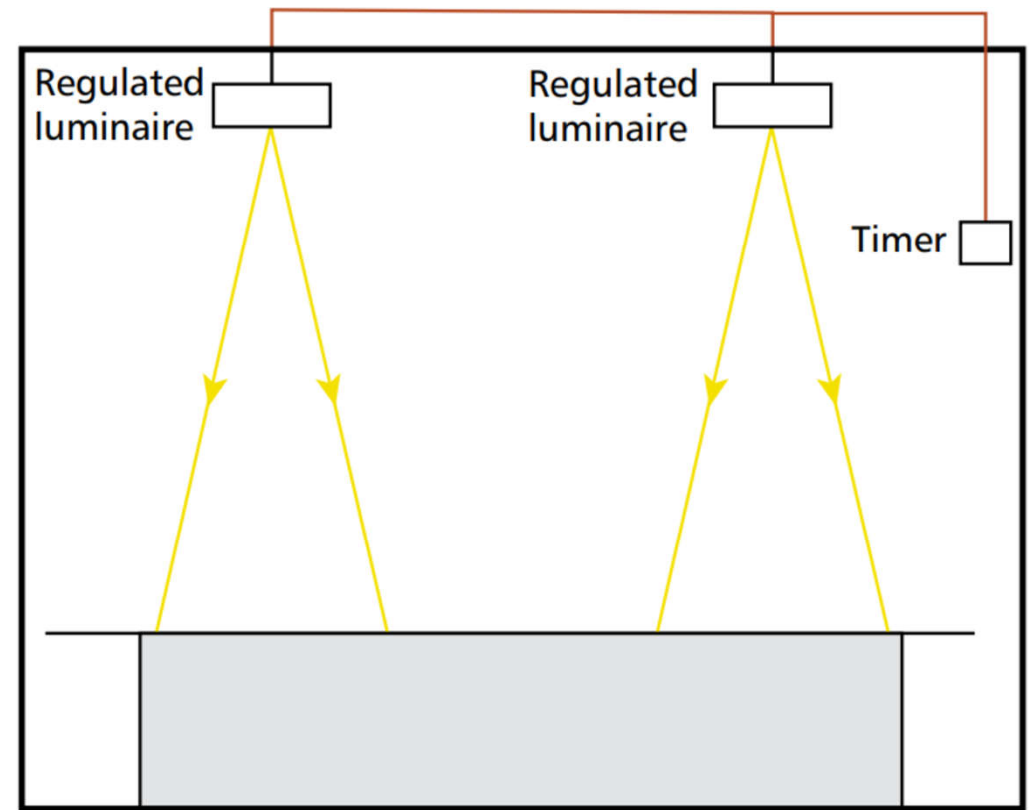

(b) a timer/data connection is used to regulate the luminaire output at a pre-set level based on 'hours run/maintenance offsets' feedback from the luminaires and manufacturer's data on lamp degradation

Example of lighting control arrangement for a typical office area

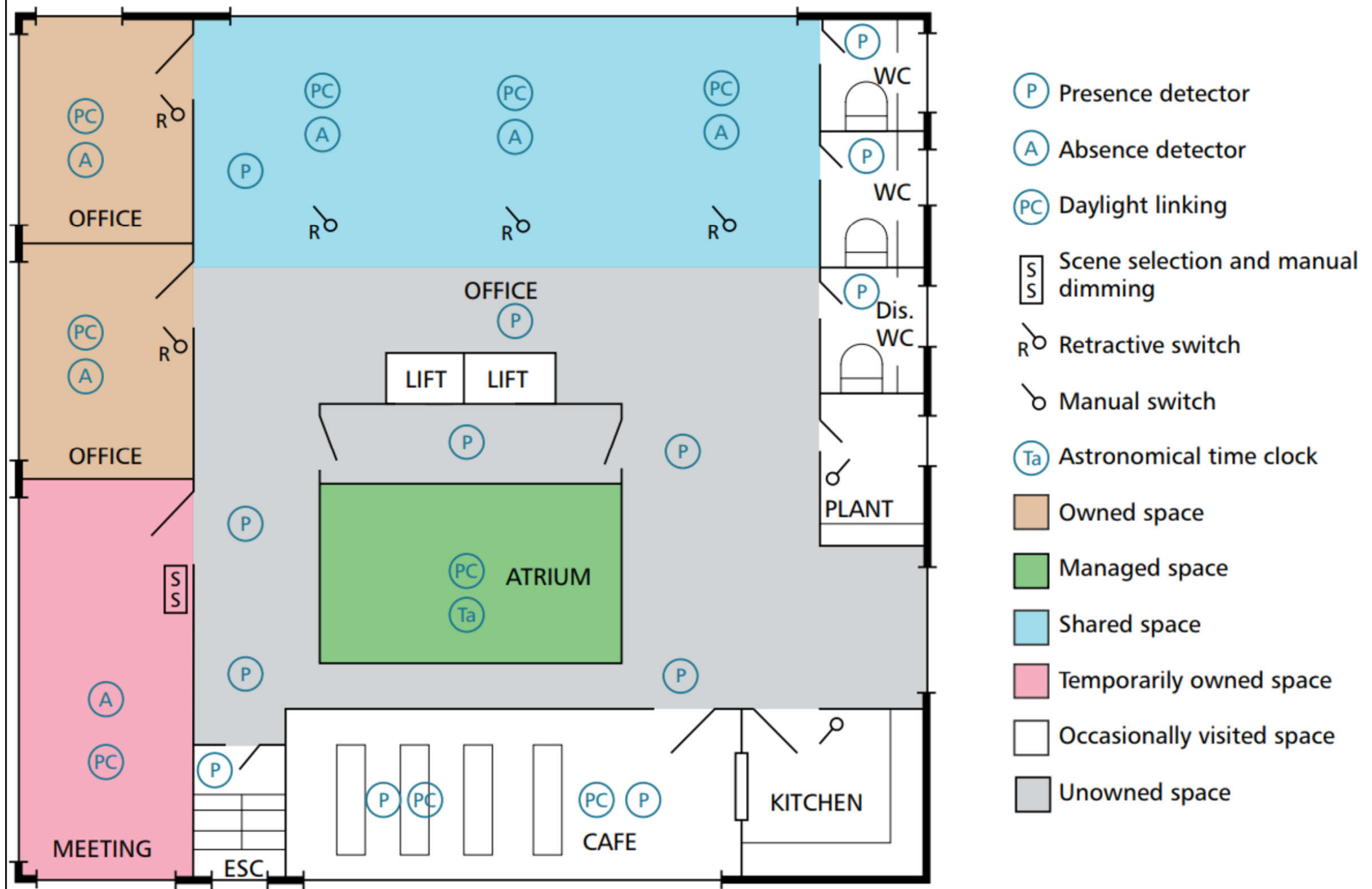

(Source: SLL, 2016. *Control of Electric Lighting*, Lighting Guide 14, Society of Light and Lighting (SLL), London.)

Lighting controls

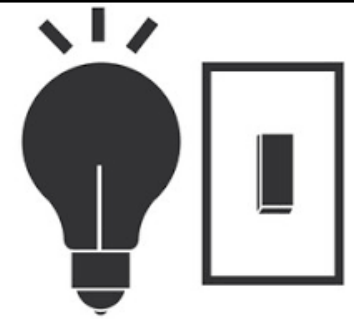

- The input to lighting controls may be manual, automatic or a combination of the two
 - Such as a manual-ON wallbox occupancy sensor
 - The automatic input may be based on time of day, occupancy, light level or some other condition
 - A microprocessor or logic circuit performs this function
- Sensor-based lighting control
 - Occupancy-based
 - Illumination-based



Manual & automatic lighting control strategies (manual-ON wallbox occupancy sensor)

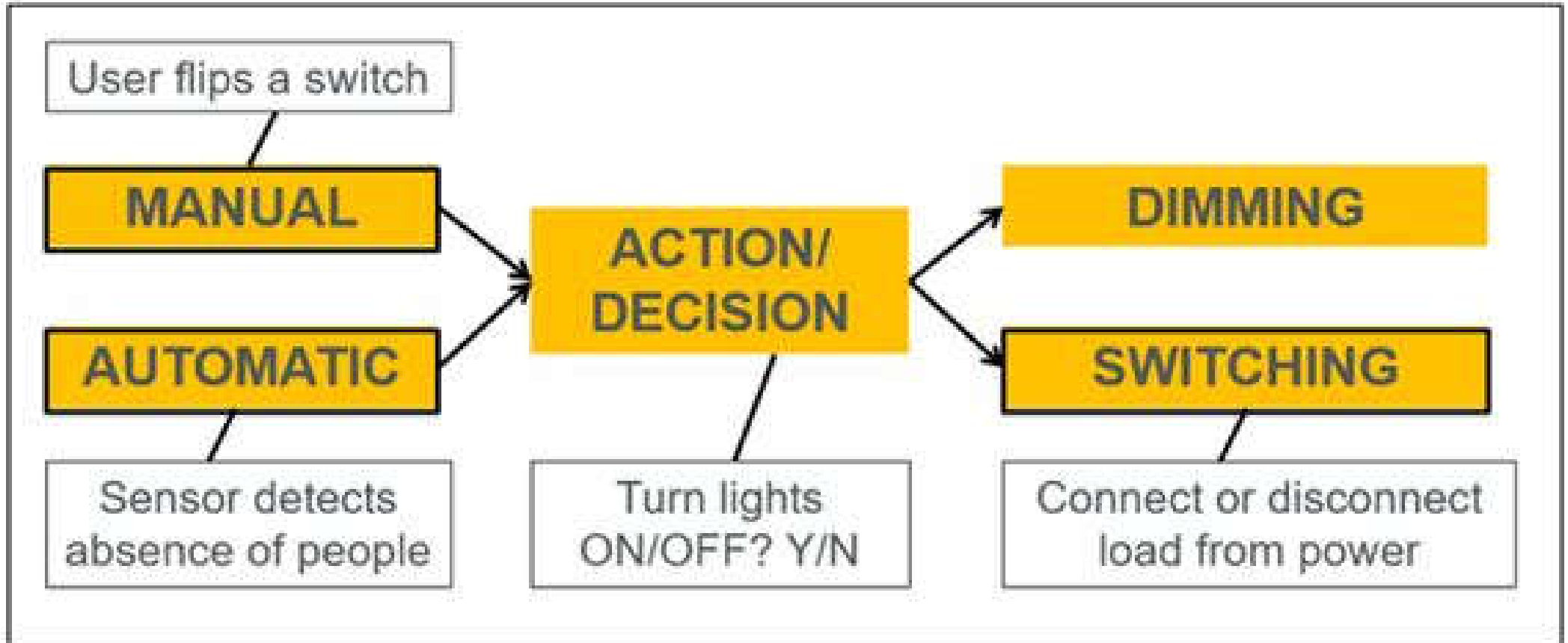

MANUAL-ON OCCUPANCY (VACANCY) SENSOR

Categories of control strategies and schemes of lighting systems

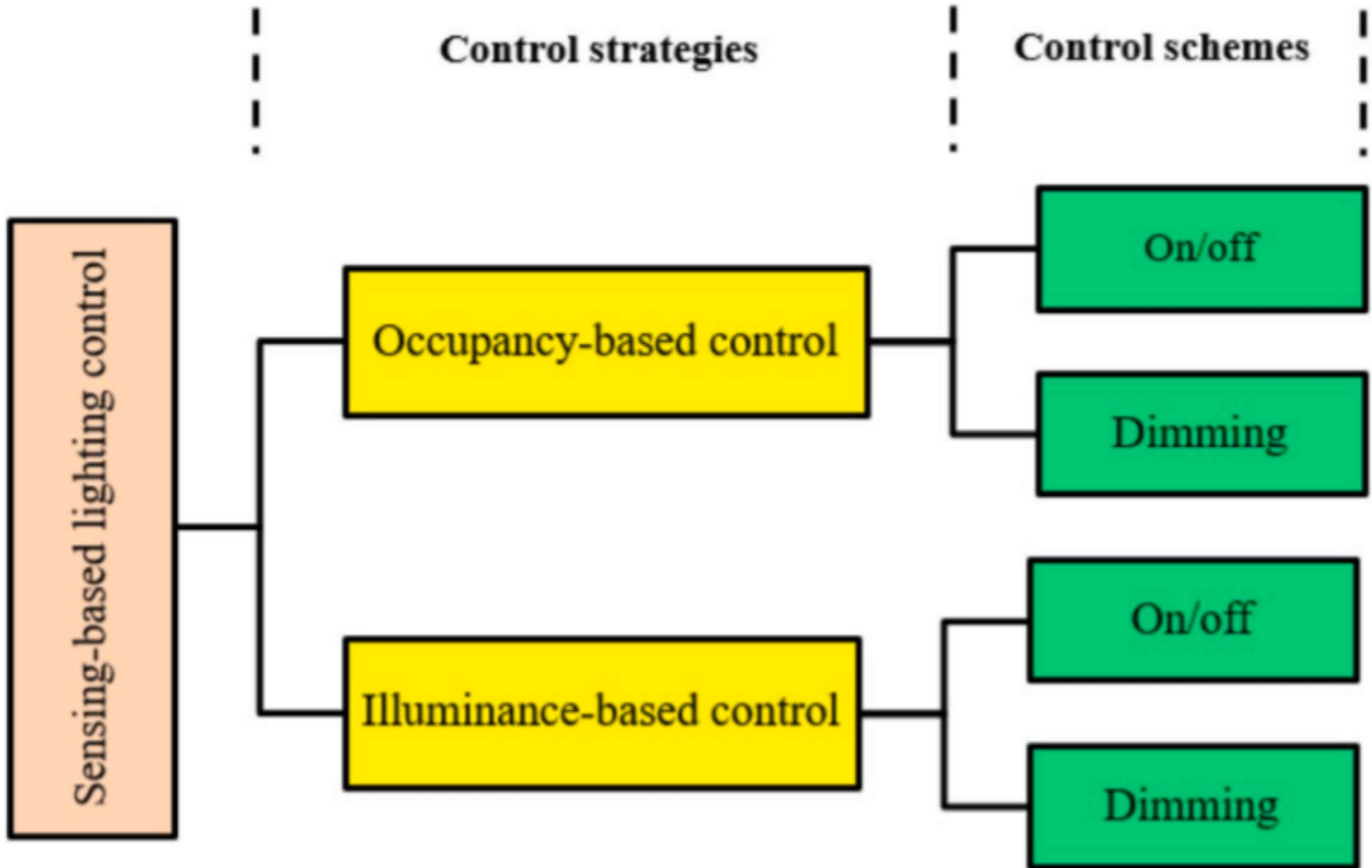

An example of control zoning for lighting control system

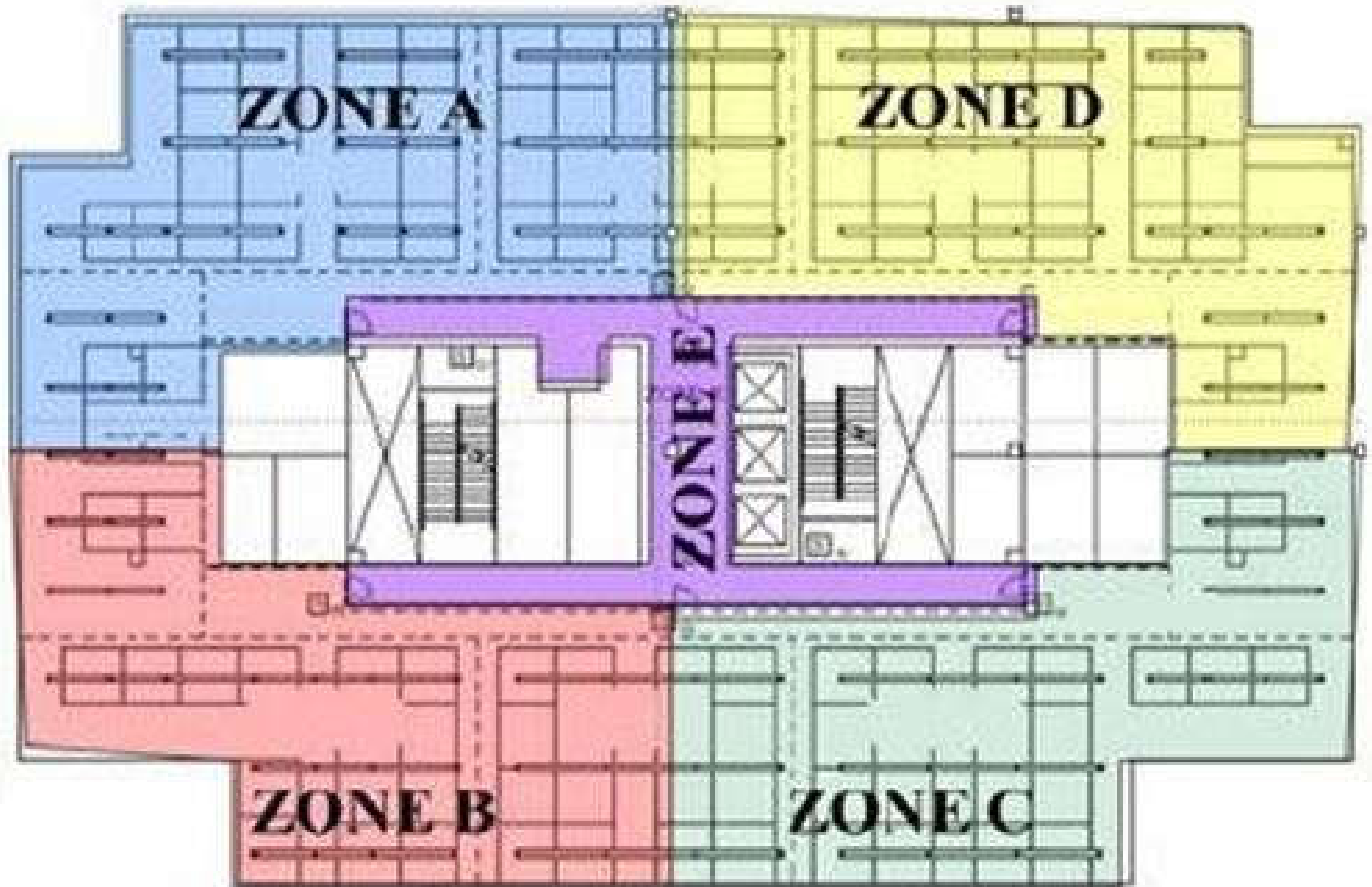

Lighting controls

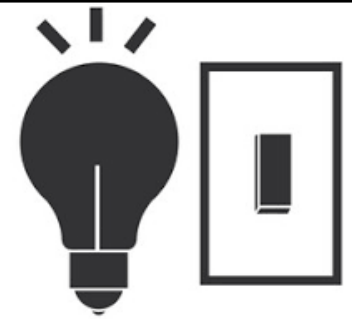

- In recent years, lighting controls have evolved two additional capabilities:
 - Adjust light source colour, including shade of white light (using LED light source)
 - Generate data via measuring and/or monitoring
- Basic functions of lighting controls
 - Switching (ON/OFF)
 - Dimming
 - Colour & correlated colour temperature (CCT)

Basic and advanced functions of lighting controls

(a) Basic functions:

WHAT	HOW
Produce the right amount of light...	Light output (intensity) dimming
...where the light is needed...	Zoning of luminaires to controllers
...and when the light is needed...	Automatically reduce lighting when the space is unoccupied

(a) Advanced functions:

WHAT	HOW
Produce light at the right colour or shade of white light...	Separately dimming arrays of LEDs with different colours or white-light correlated colour temperatures (CCTs)
...allow remote programming and control...	Control systems with programming and lighting management capability
...and tell you how your lights are performing...	Centralized intelligent control systems with measuring and/or monitoring/alarm capability

Switching & dimming lighting controls

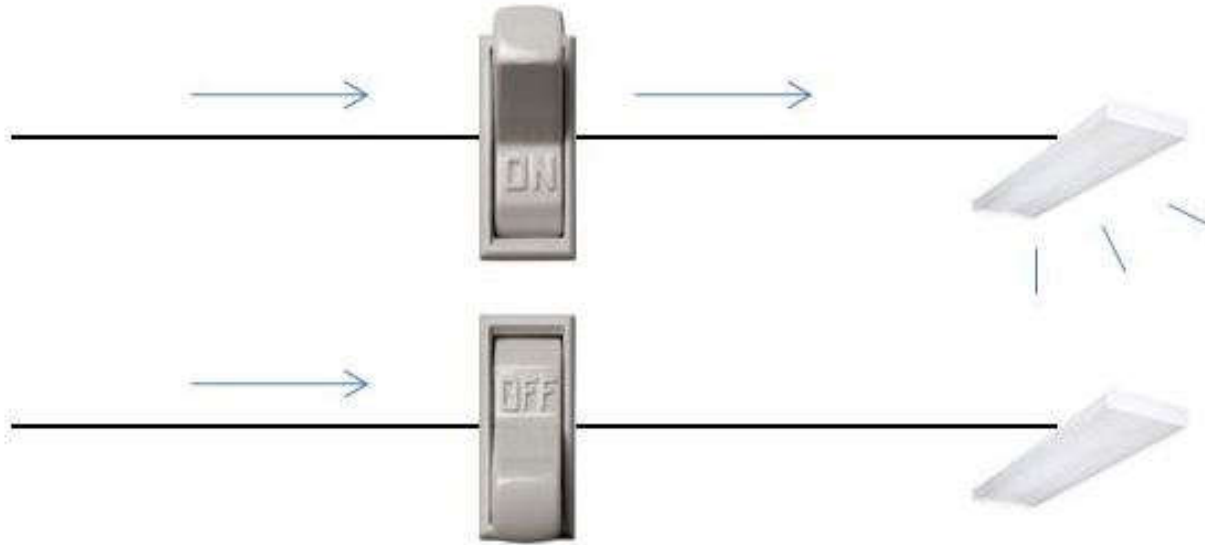

(a) Switching (ON/OFF)

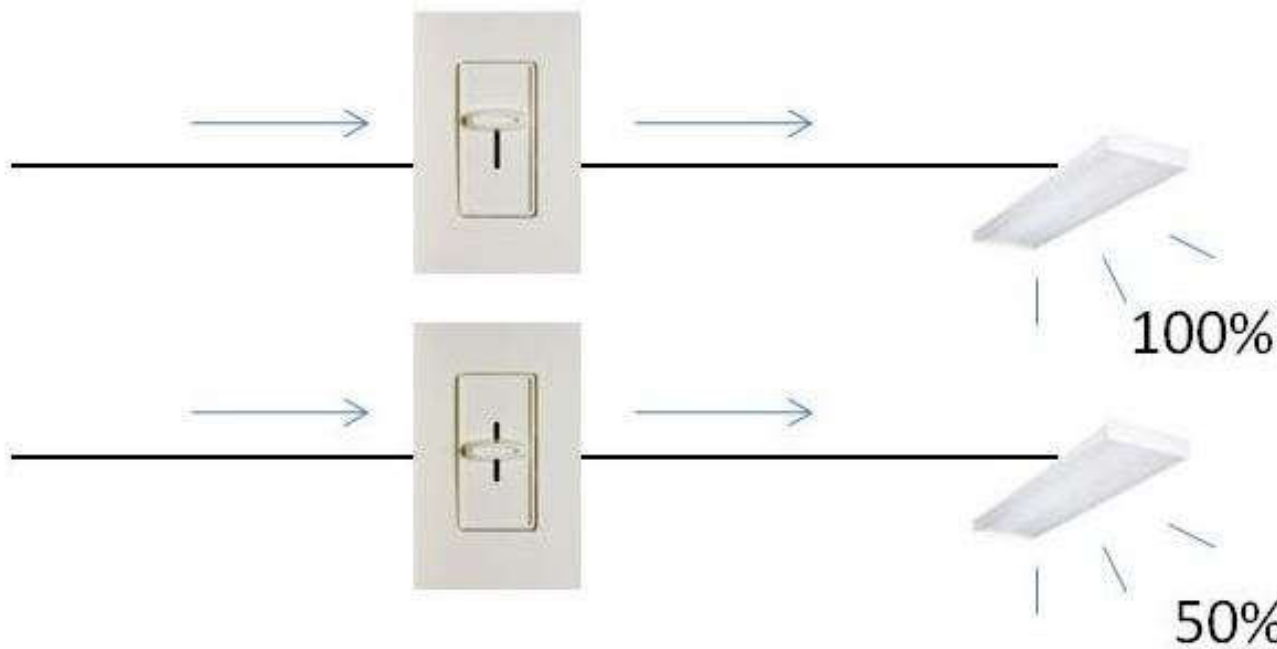

(b) Dimming

Lighting control of correlated colour temperature (CCT)



5500K, Full on 100%



3800K, Dimmed to 75%



2400K, Dimmed to 50%

(Source: <https://lightingcontrolsassociation.org/2017/07/21/introduction-to-lighting-controls/>)

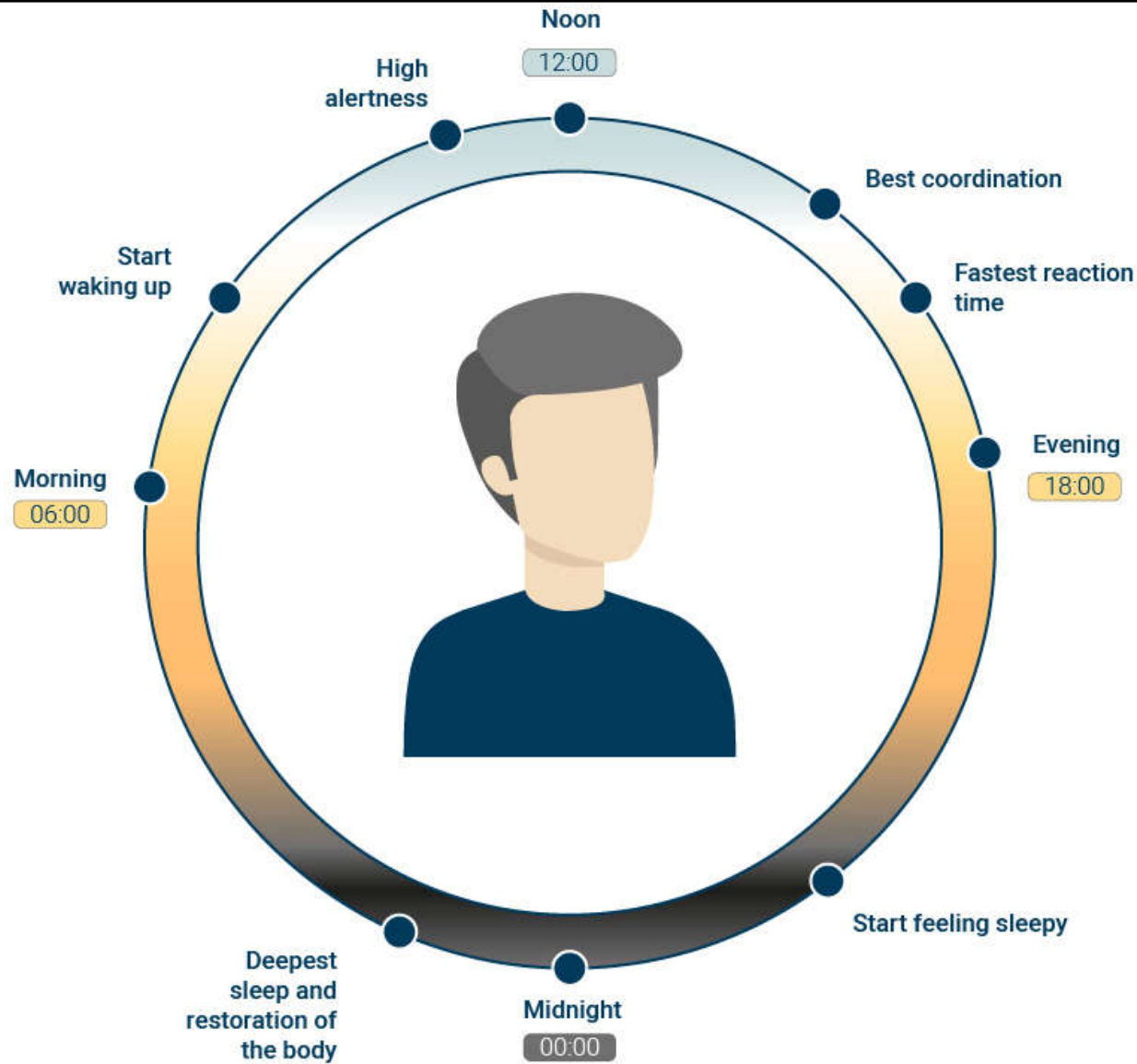

Physiological and psychological benefits of human centric lighting (HCL)

Morning



Cool light.
High intensity.

Afternoon



White light.
High intensity.

Evening



Warm light.
Low intensity.

Night



No light.

Control of colour temperature for human centric lighting (HCL) & circadian cycles

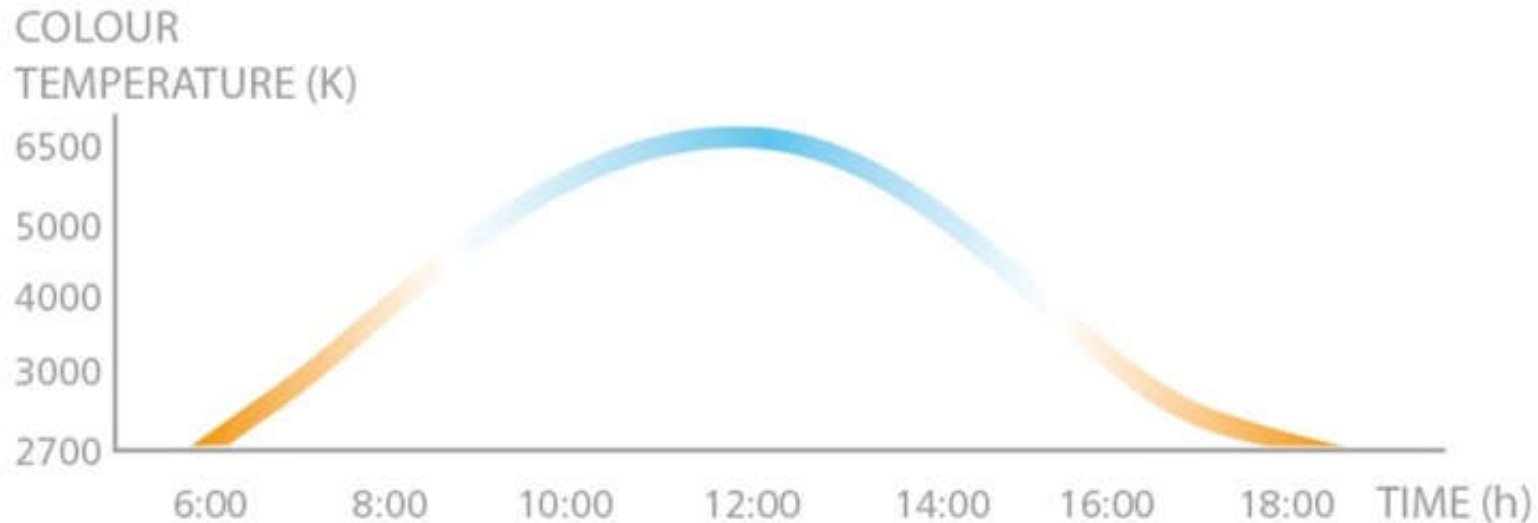
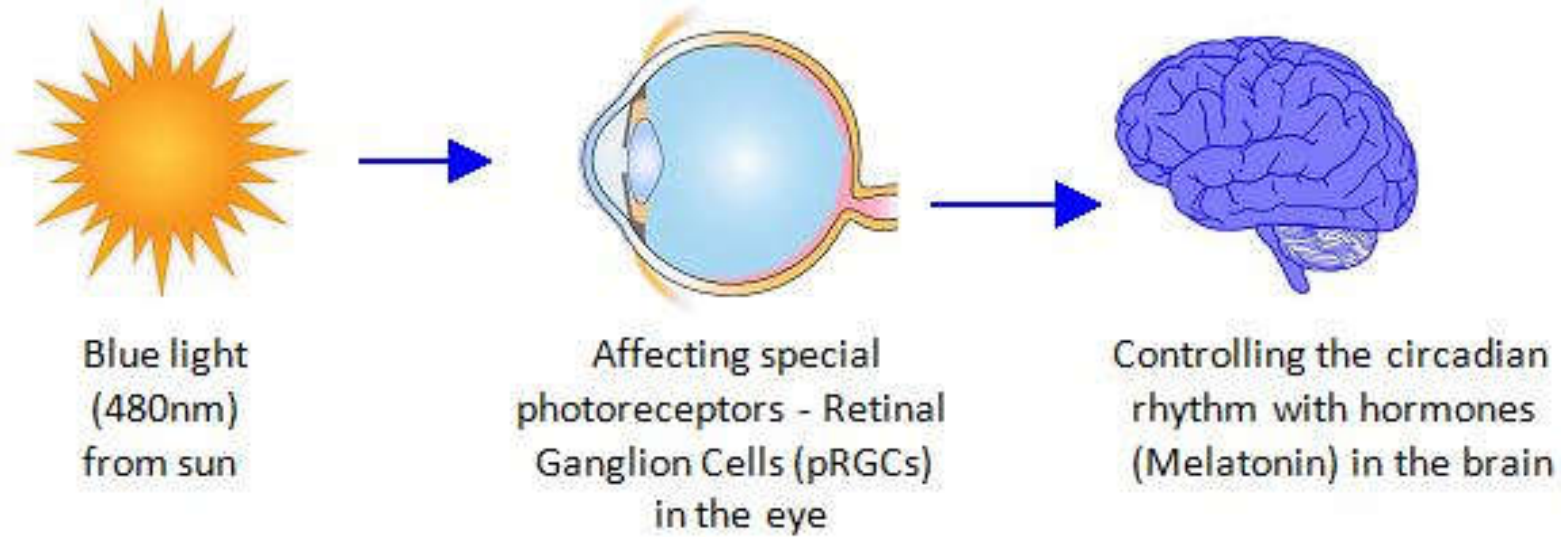

Considerations of lighting colour for non-visual effects

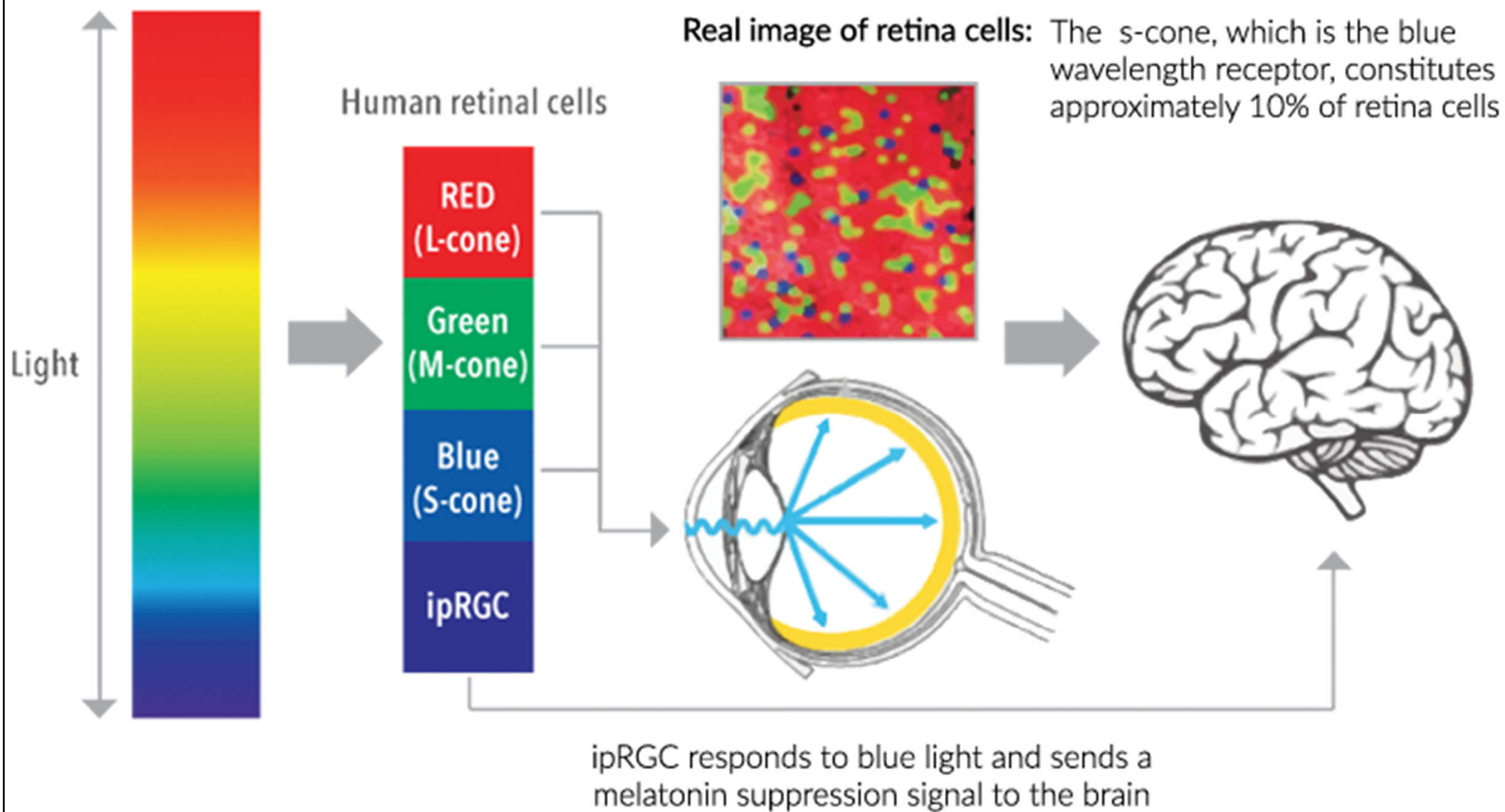

Tuning & control of spectrum for human centric lighting (HCL)

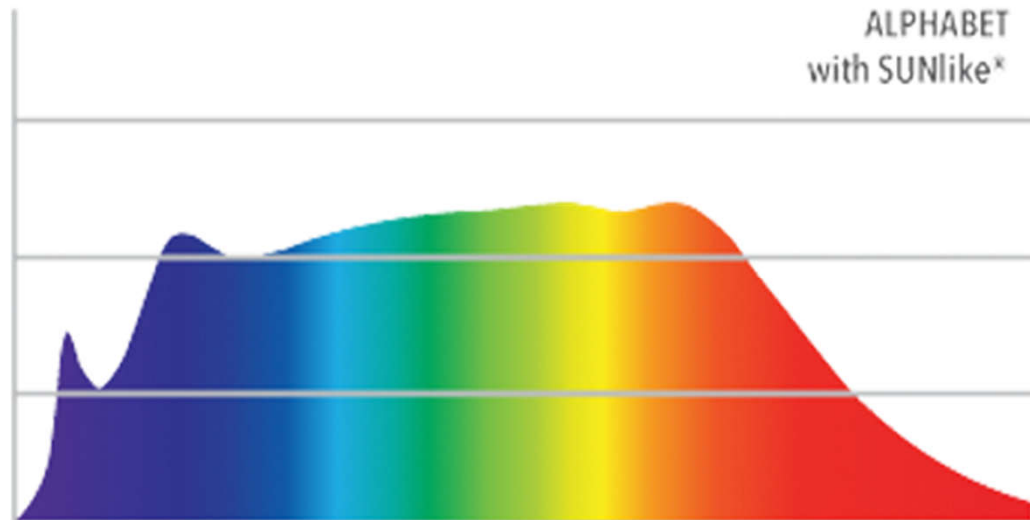
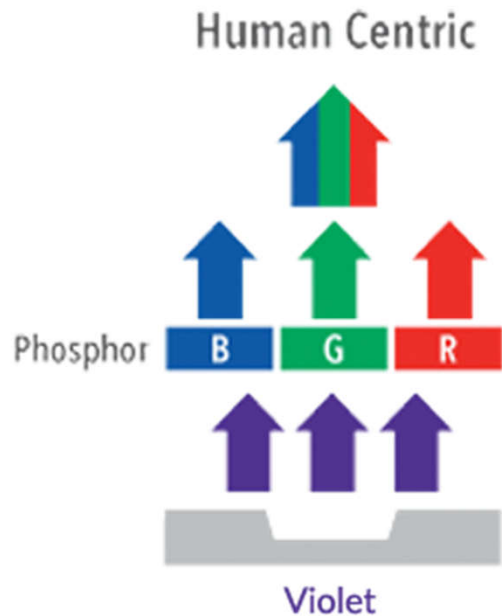
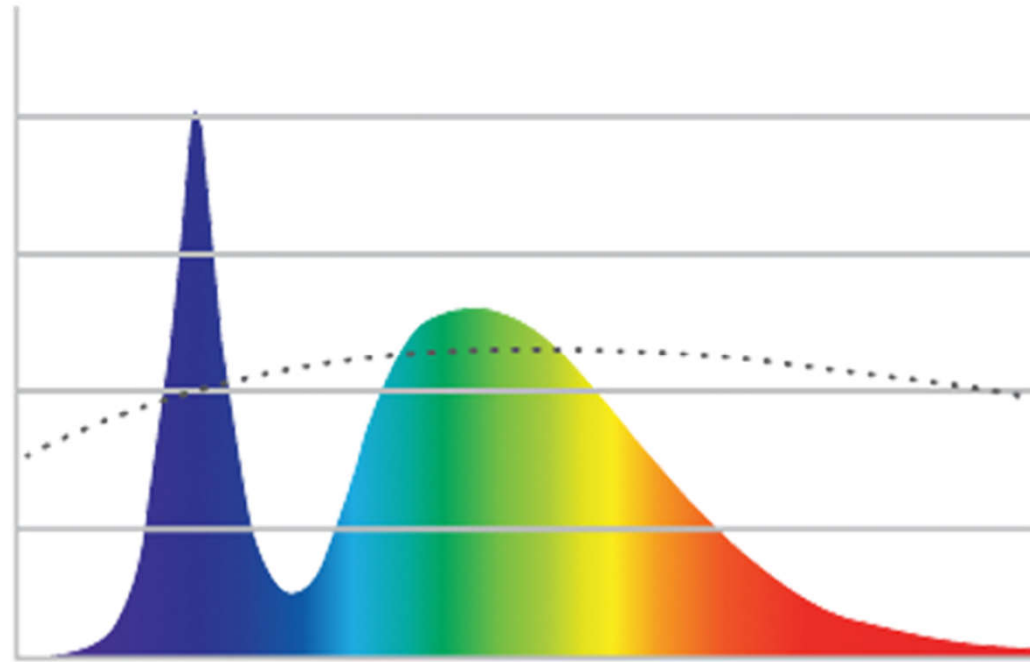
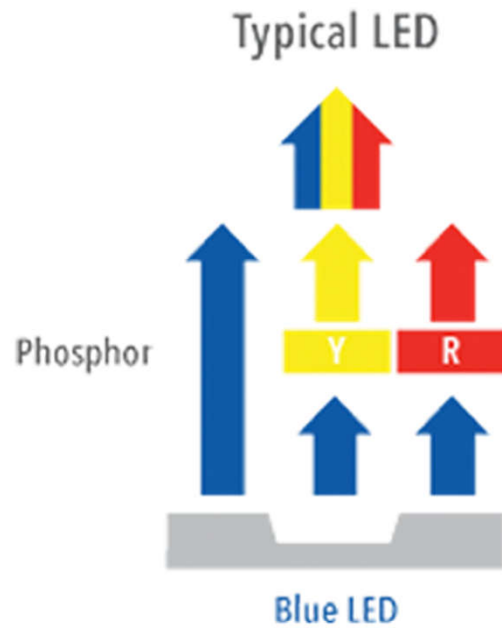

Photopic curves & spectral sensitivity for visual & non-visual biological responses (melanopic & blue light hazard)

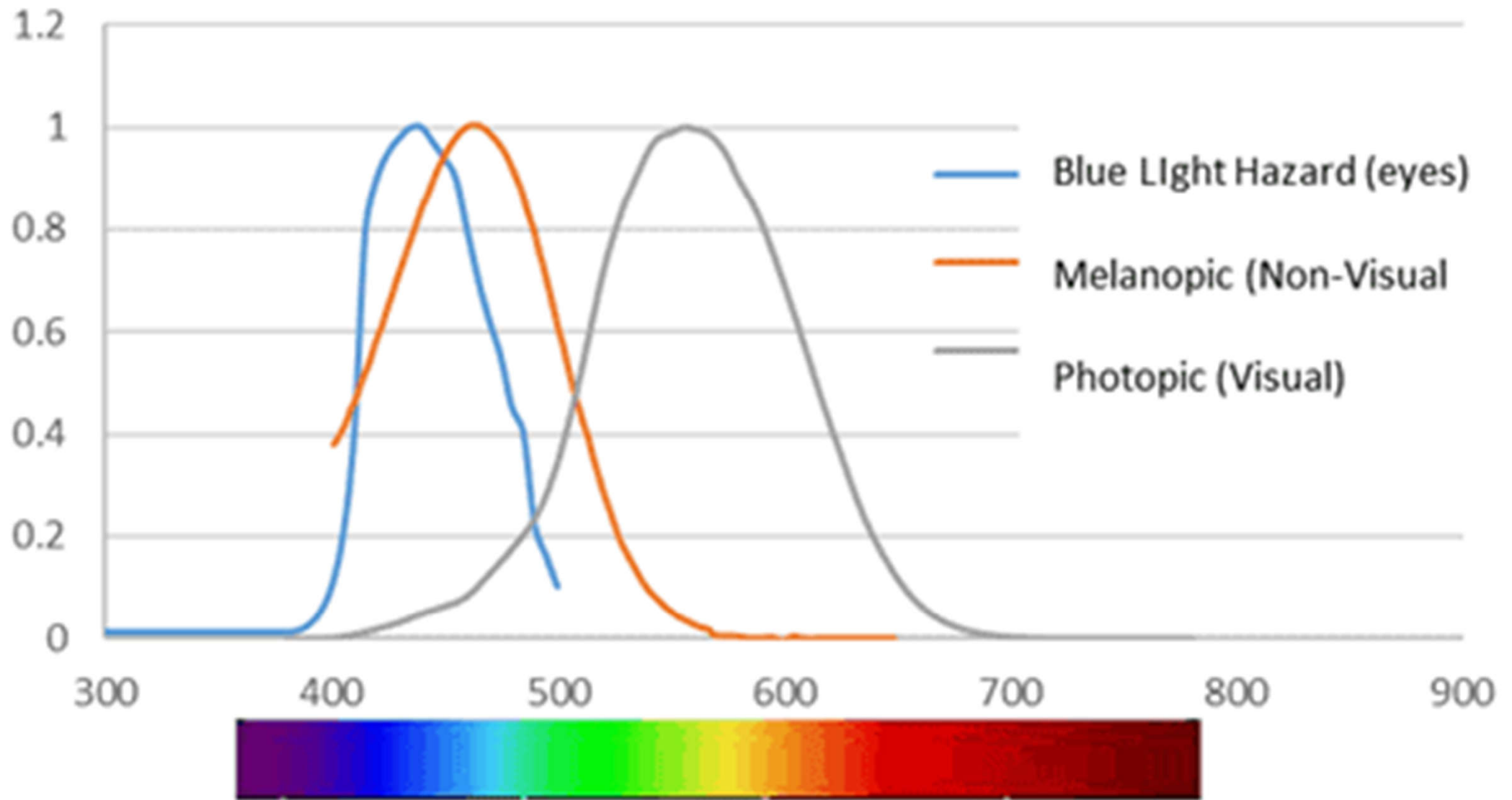

Wired & wireless systems



- **Wired systems**

- Line-voltage wiring (powerline communication)
- Low-voltage wiring (dedicated pathway for control signals, analogue)
- Digital low-voltage wiring (digital binary signals)

- **Wireless systems**

- Eliminate control wiring
- Control signals from a wireless transmitter to a wireless receiver in a lighting controller

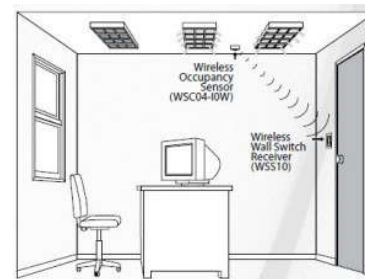

Luminaires connected to a lighting control module (LCM)

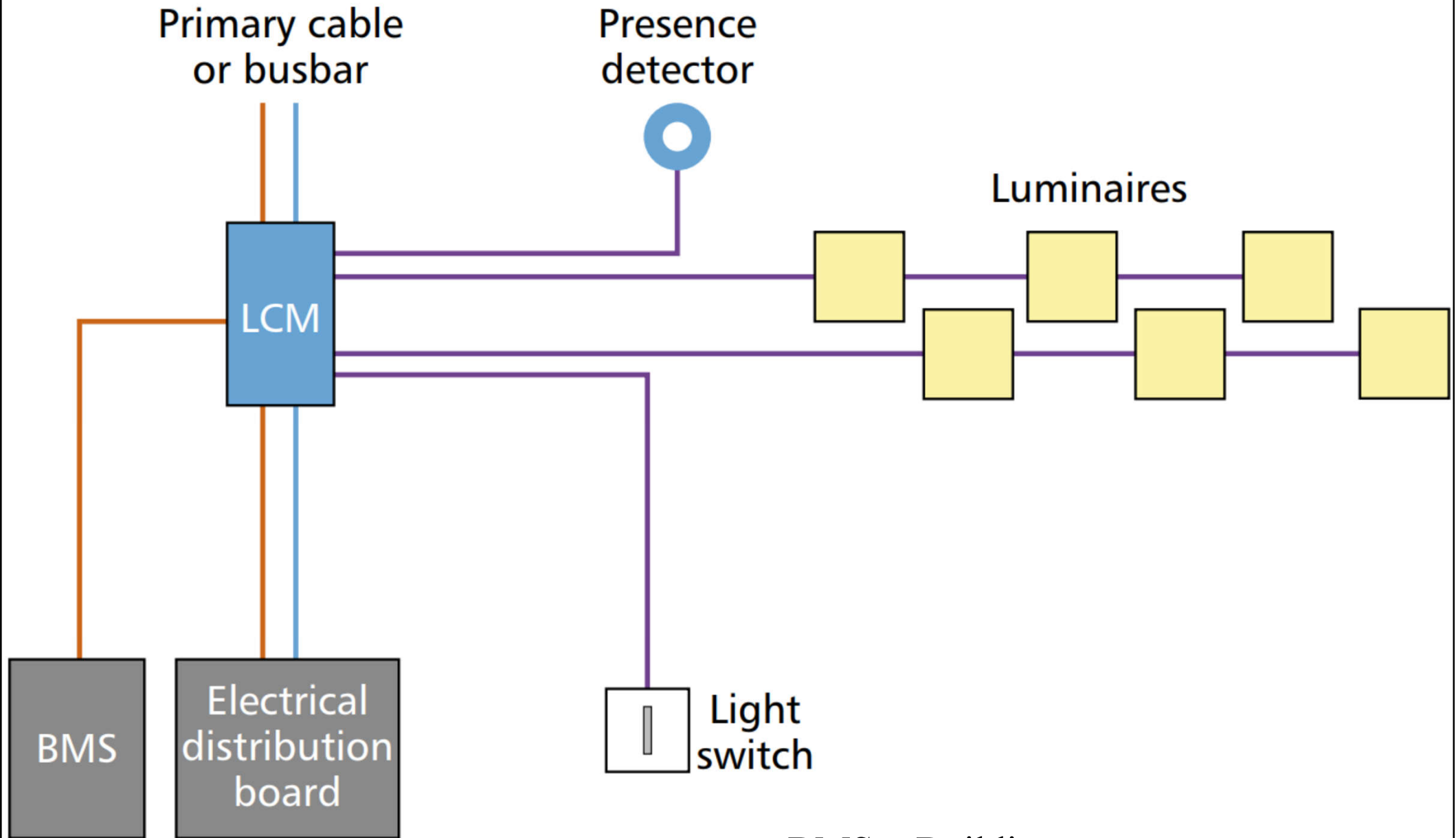

BMS = Building management system
LCM = Lighting control module

An example of wired & wireless controls for open office layout

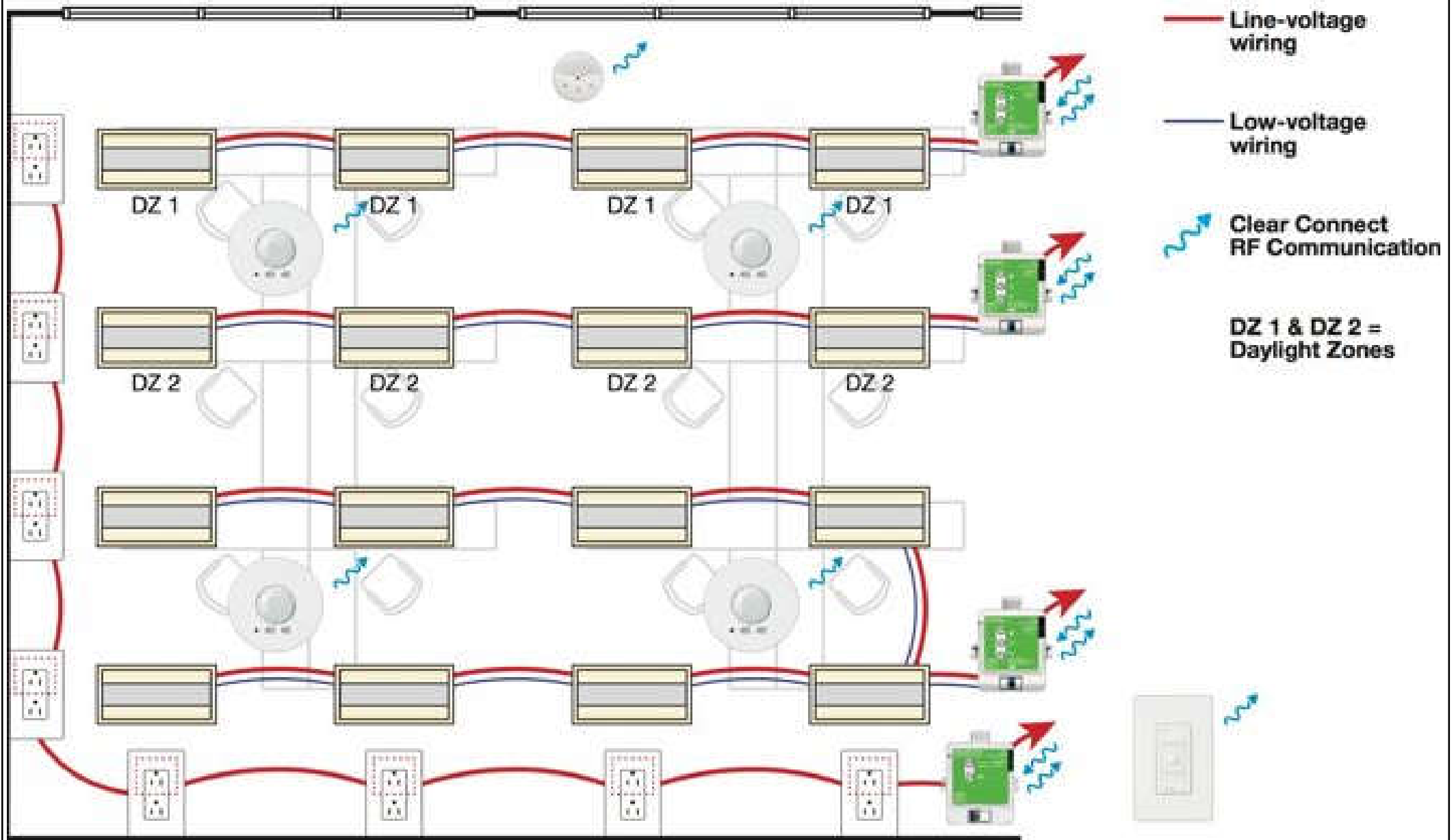

Wireless lighting control systems

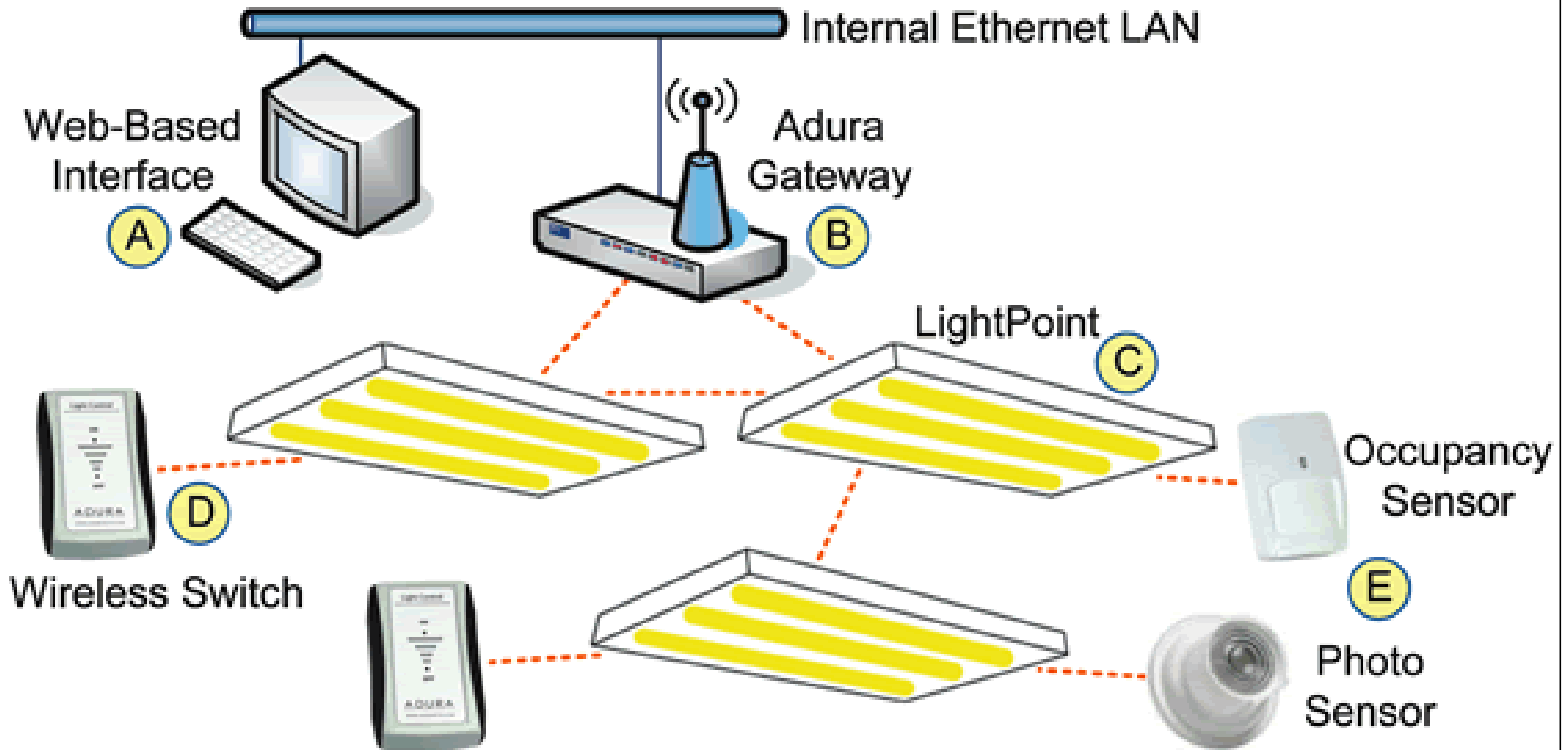

Wireless control systems for lighting, HVAC & plug loads

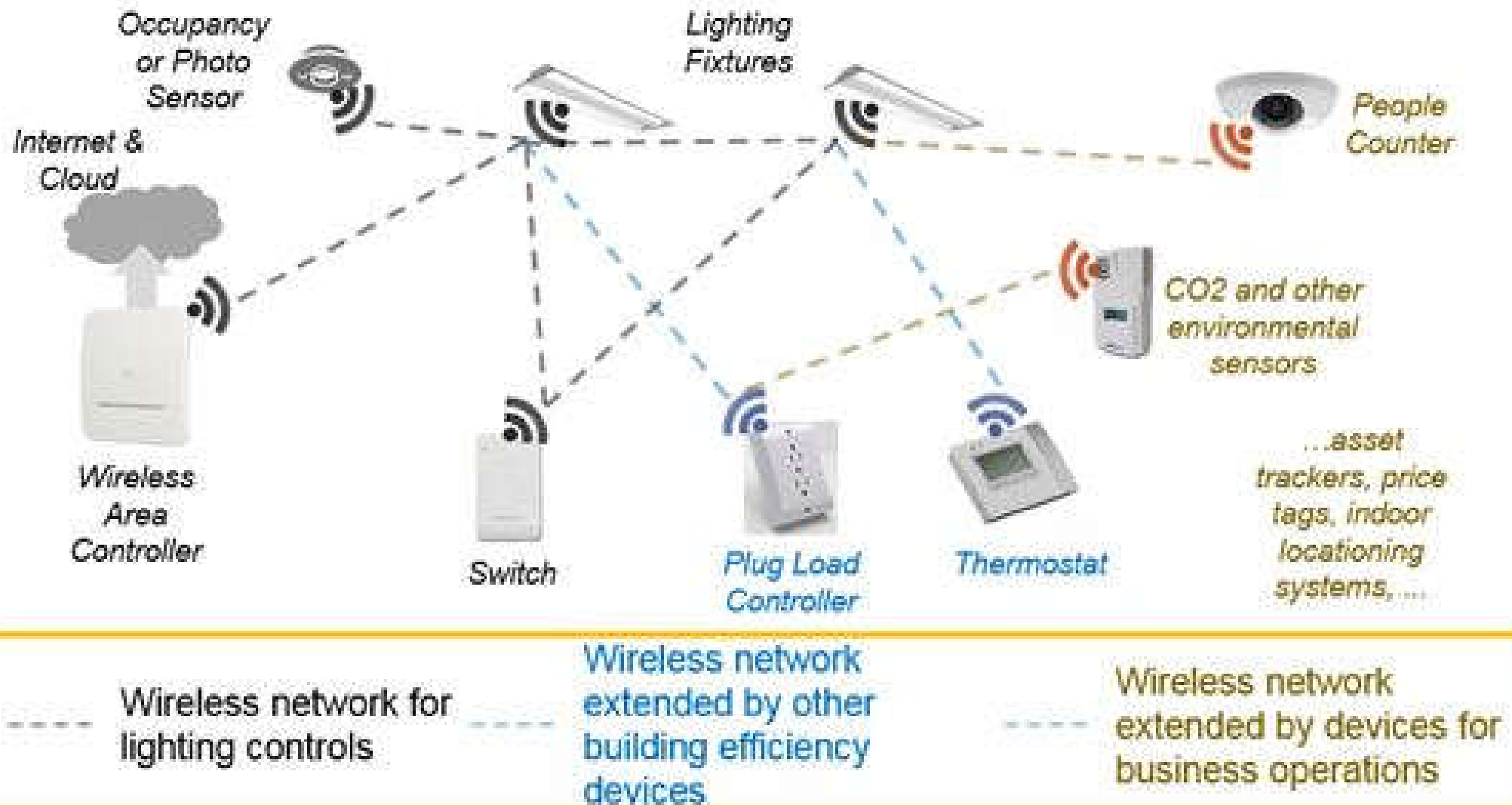

Wired & wireless systems



- **Digital Addressable Lighting Interface (DALI)**
 - A protocol (language) for bi-directional, digital communication between lighting-control devices
 - Technically managed in the open, global standard IEC 62386
 - DALI-2™ is the certification program based on the latest version of the DALI protocol
 - Setting standard for smart lighting control
 - Focused on interoperability



Digital Addressable Lighting Interface (DALI) & IEC 62386 standard

IEC 62386 standard

Purchase standards via the [IEC website](#)
More details on IEC 62386: [DiiA website](#)

Red text = Parts aligned with DALI-2

Part 101: General requirements – System components

Part 102: General requirements – Control gear

Part 104: General requirements – Wireless and alternative wired systems

Part 103: General requirements – Control devices

Parts 2xx: Particular requirements for control gear

Part 105: General requirements – Firmware update (In progress)

Parts 3xx: Particular requirements for control / input devices

Published:

Part 201: Fluorescent lamps

Part 202: Self-contained emergency lighting
Part 203: Discharge lamps (excluding fluorescent lamps)
Part 204: Low voltage halogen lamps
Part 205: Supply voltage controller for incandescent lamps
Part 206: Conversion from digital signal into DC voltage

Part 207: LED modules

Part 208: Switching function
Part 209: Colour control

Published:

Part 216: Load referencing
Part 217: Thermal gear protection
Part 218: Dimming curve selection
Part 220: Centrally-supplied DC emergency operation
Part 221: Load shedding
Part 222: Thermal lamp protection
Part 224: Integrated light source

Published:

Part 301: Push buttons
Part 302: Absolute input devices
Part 303: Occupancy sensors
Part 304: Light sensors
Part 332: Input control devices - Feedback
Part 333: Manual configuration

In progress:

Part 305: Colour sensor

DiiA creates DALI-2 Test Procedure specifications based on these individual Parts of IEC 62386, enabling DALI-2 certification.

Wired & wireless systems



- **Digital Addressable Lighting Interface (DALI)**
 - A 2-wire bus is used for communication (commands/data) & for power to some devices
 - Commands allow control, configuration & querying of the products
 - Commands can be addressed to individual devices, to a group of devices, or broadcast to all devices
 - Scenes allow fast & efficient recall of light levels across the system
 - DALI devices: bus power supplies, control gear, control devices

DALI lighting-control system example

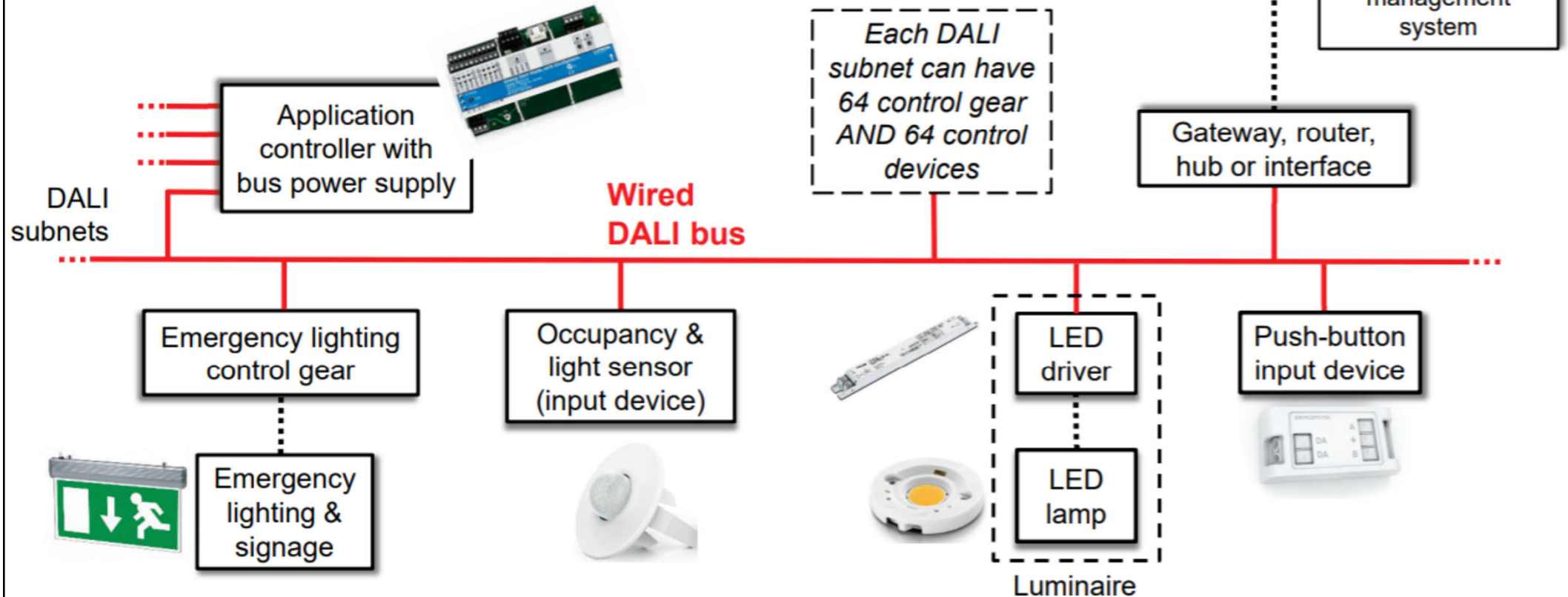

The DALI bus carries DALI power & data on the same pair of wires. Each DALI subnet can have 64 control gear & 64 control devices. Control gear provide power to LEDs & other light sources. Control devices include application controllers (which make decisions & send commands), and input devices such as sensors, switches & push-button devices. A bus power supply is required, providing up to 250 mA and typically 16V to the DALI bus.

Wired & wireless systems



- What can DALI do?
 - Digital control of light with intelligent feedback
 - Precise, repeatable light-output control & standardized dimming curve
 - Occupancy & light-level sensing
 - Luminaire, energy & diagnostics data (for monitoring)
 - Emergency lighting, automated tests (safety)
 - Colour control for human-centric-lighting (well-being)
 - Participate in the Internet of Things (IoT)
 - Connectivity via wireless & IP-based networks

Elements of lighting intelligence

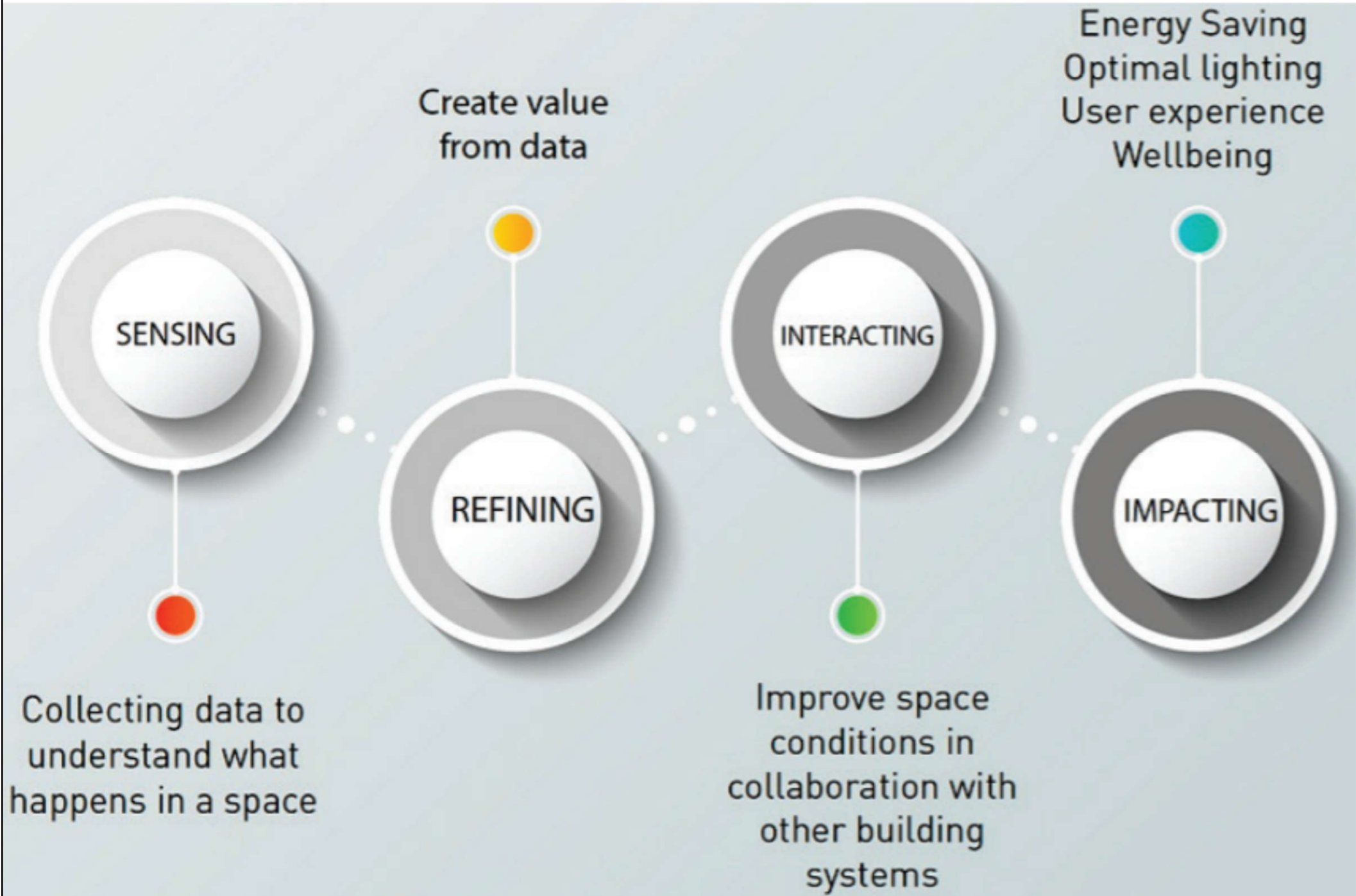

Wired & wireless systems



- D4i – the DALI standard for intelligent, IoT-ready luminaires
 - DALI-2 power-supply & data specifications
 - D4i LED drivers & sensors provide luminaire, energy & diagnostics data
 - For performance monitoring, asset management, predictive maintenance & many other tasks
 - Enables intra-luminaire DALI (smart connection)
 - Simplify addition of sensors & communication devices to luminaires



DALI data & D4i: An outdoor street lighting example



In the factory:
Luminaire data is programmed into drivers.

During operation:
Performance monitoring

- Energy usage data can be used e.g. for billing



Network

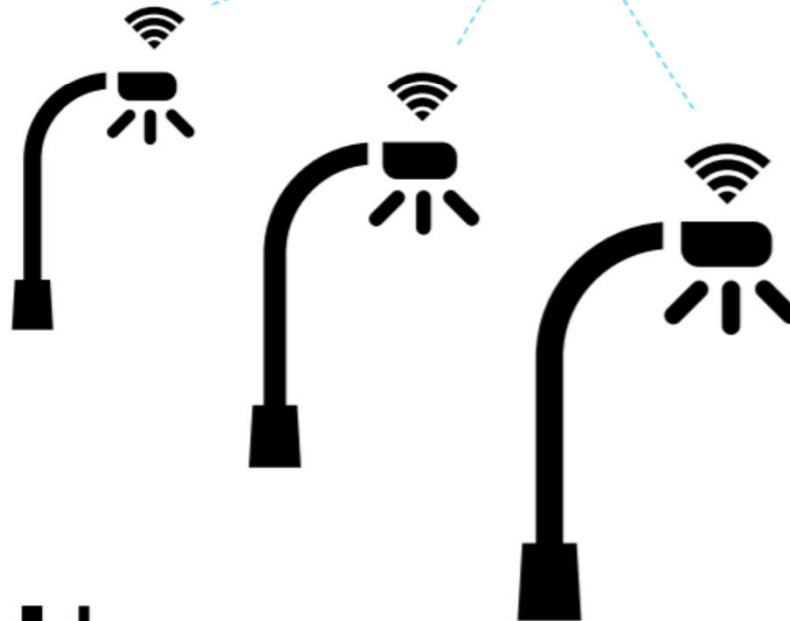

In the field:

Automated commissioning

- When installed, luminaire can automatically transfer data to remote network
- Reduces human error, saves installation time and cost
- Operator has a full map of asset information

During operation:

Predictive maintenance

- Diagnostics data allows network operator to anticipate need for maintenance
- Repair team has knowledge of location and type of fixture



Wired & wireless lighting control

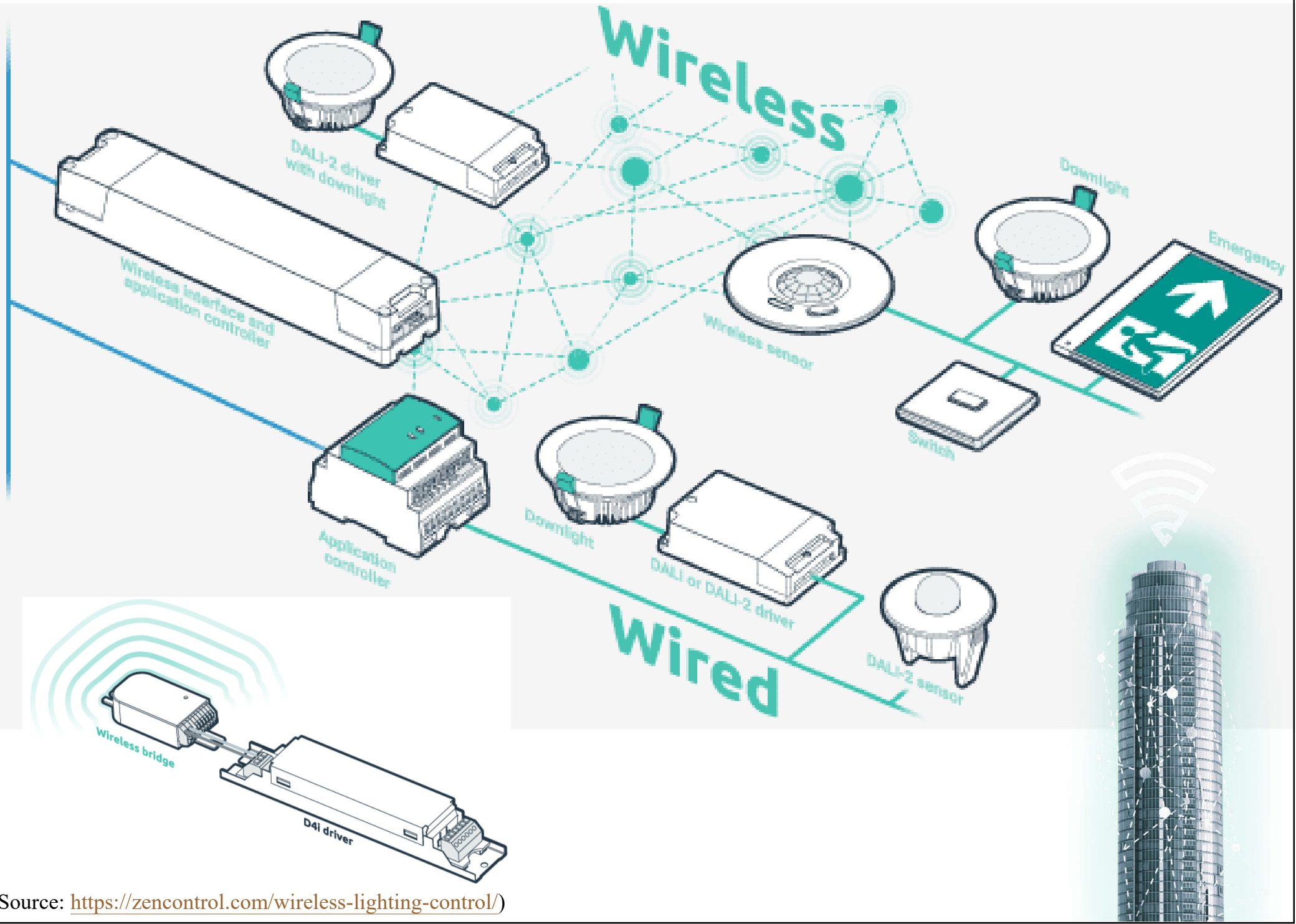

DALI lighting control plus wireless & IP-based networking



DALI+ wireless devices in a mesh network

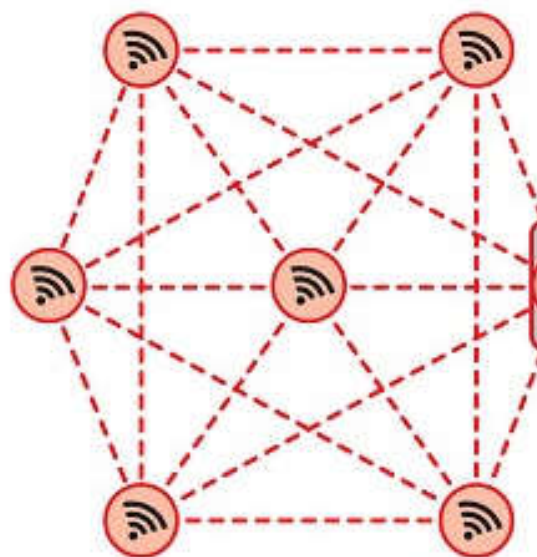

Bridge between DALI wired and wireless

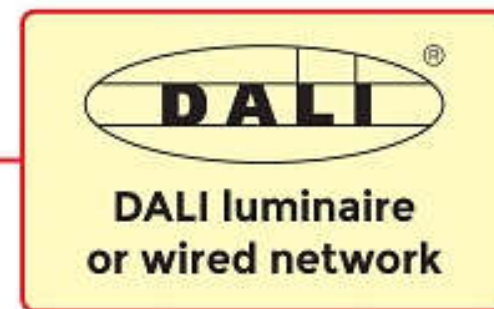

Smart lighting



- **Connected smart lighting**
 - Lighting installations in which the luminaires, with integrated sensors, are interconnected in a wired or wireless network to both control & monitor the lighting
 - Microcontrollers & many sensors, like light, occupancy, temperature, humidity & noise sensors, are small enough to be incorporated in a luminaire
 - In this way, the luminaire becomes both a source of light & information (data)

Key elements for smart lighting systems

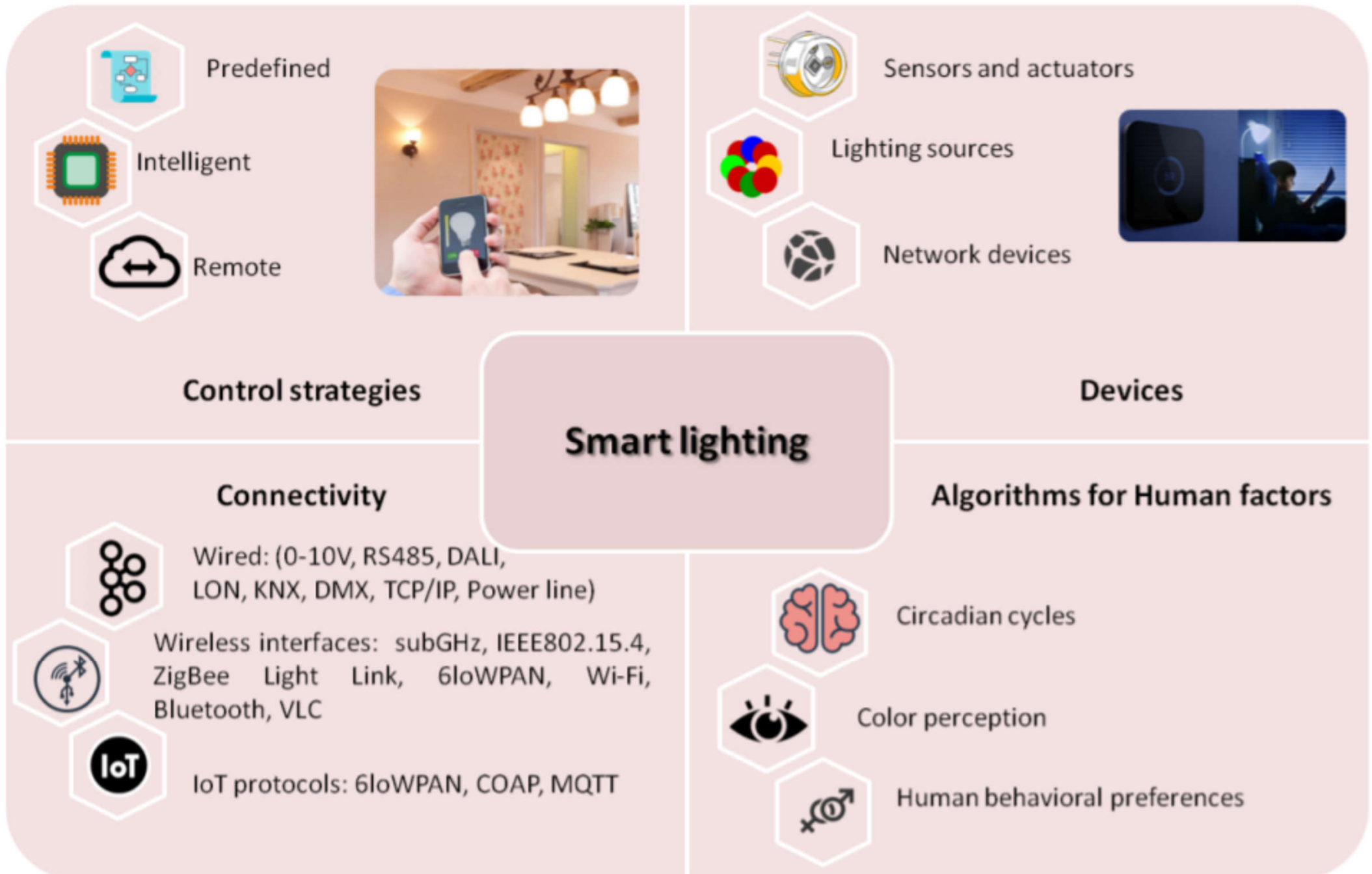

Smart lighting



- Light beyond illumination

- By connecting a network of LED luminaires with integrated sensors to a network, it becomes the backbone of the **Internet of Things (IoT)**



- For smart actions of the connected building services installations (e.g. lighting, HVAC) & facility management (e.g. automated cleaning & maintenance)

- Light from LED luminaires can be used simultaneously for lighting & wireless data transfer -> **Visible Light Communication (VLC)**

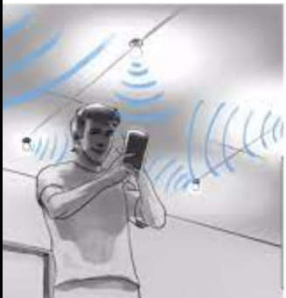

Internet of Things (IoT) connected lighting system

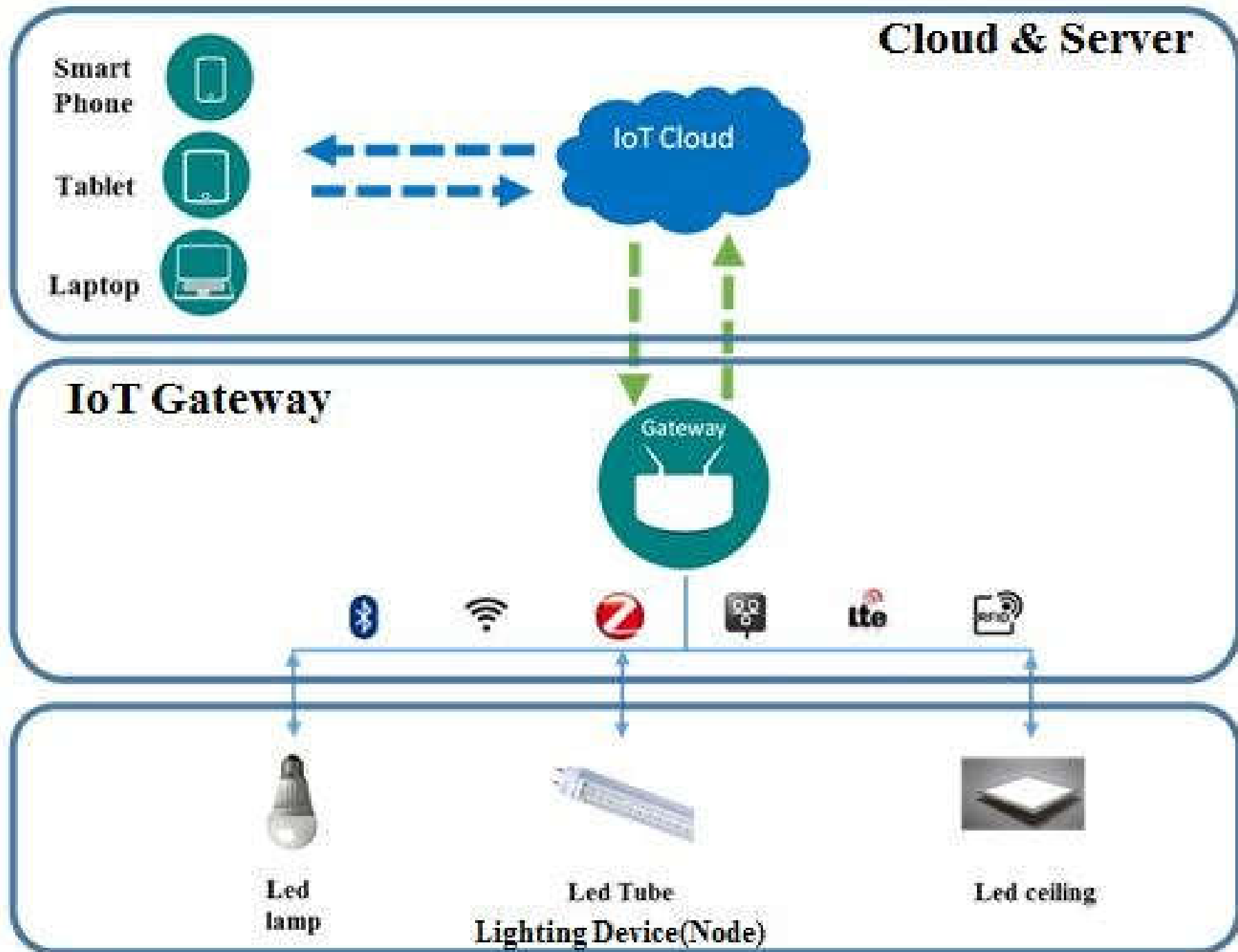

Smart lighting



- Smart lighting & Internet of Things (IoT)
 - Light points can serve as the infrastructure for IoT systems (both indoor & outdoor)
 - Smart sensor networks & connectivity
- Visible Light Communication (VLC)
 - Low power consumption, easy installation, high security, no electromagnetic interference
 - Potential uses: indoor positioning, scanning sensor, light fidelity (Li-Fi) as alternative to WiFi network

Principles of Visible Light Communication (VLC)



Transmitter

Receiver

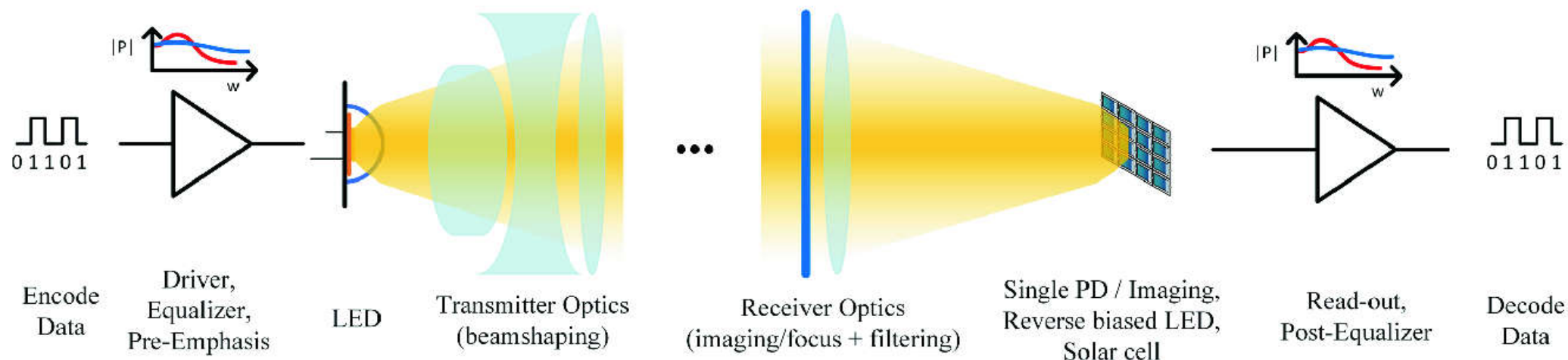

(Source: <https://enlightem.eu/a-tutorial-on-visible-light-communication-an-academic-and-industrial-perspective/>;
https://link.springer.com/chapter/10.1007/978-3-030-24892-5_8)

Visible Light Communication (VLC) environment & data transmission

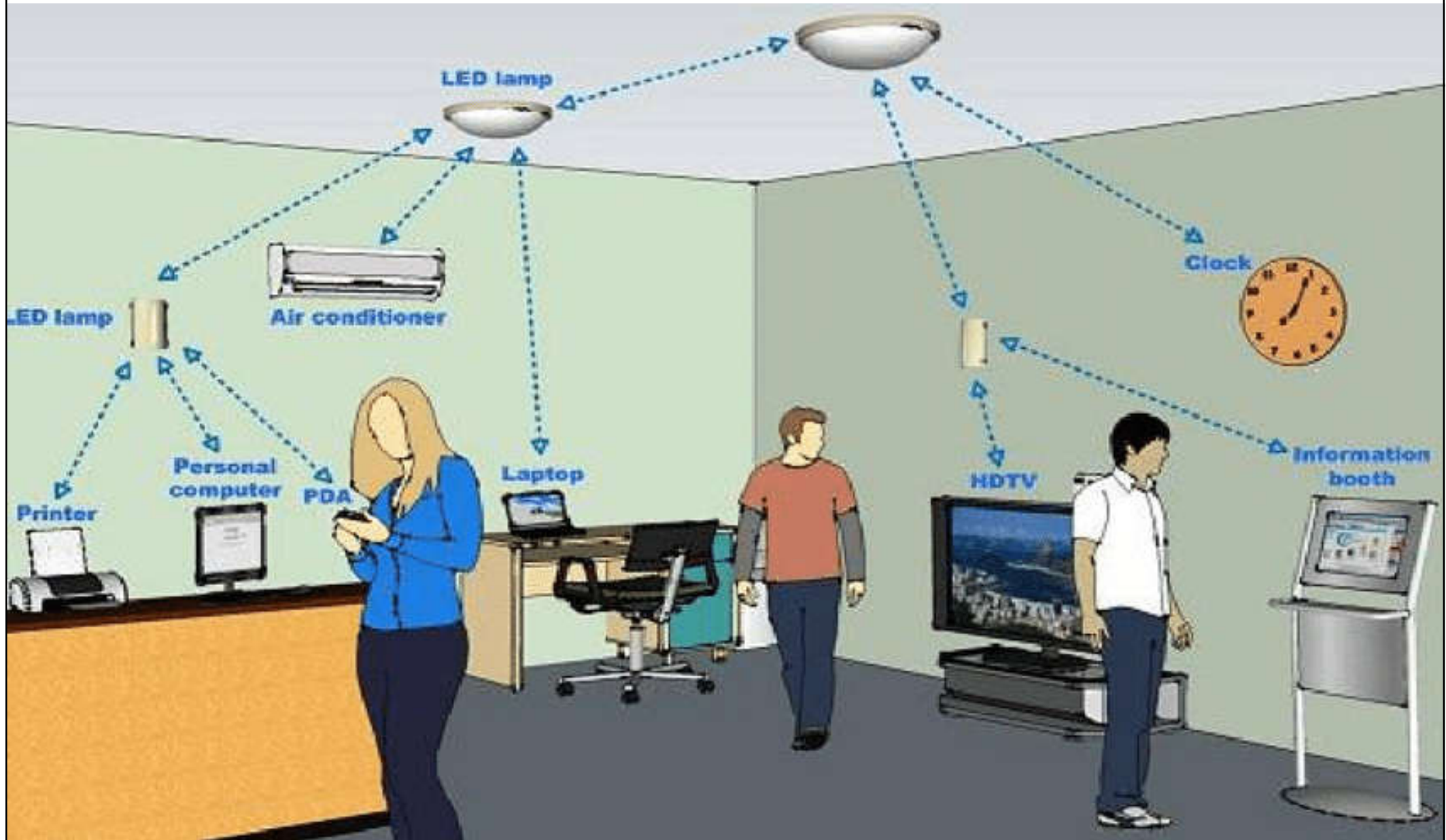

Visible light communication for indoor monitoring

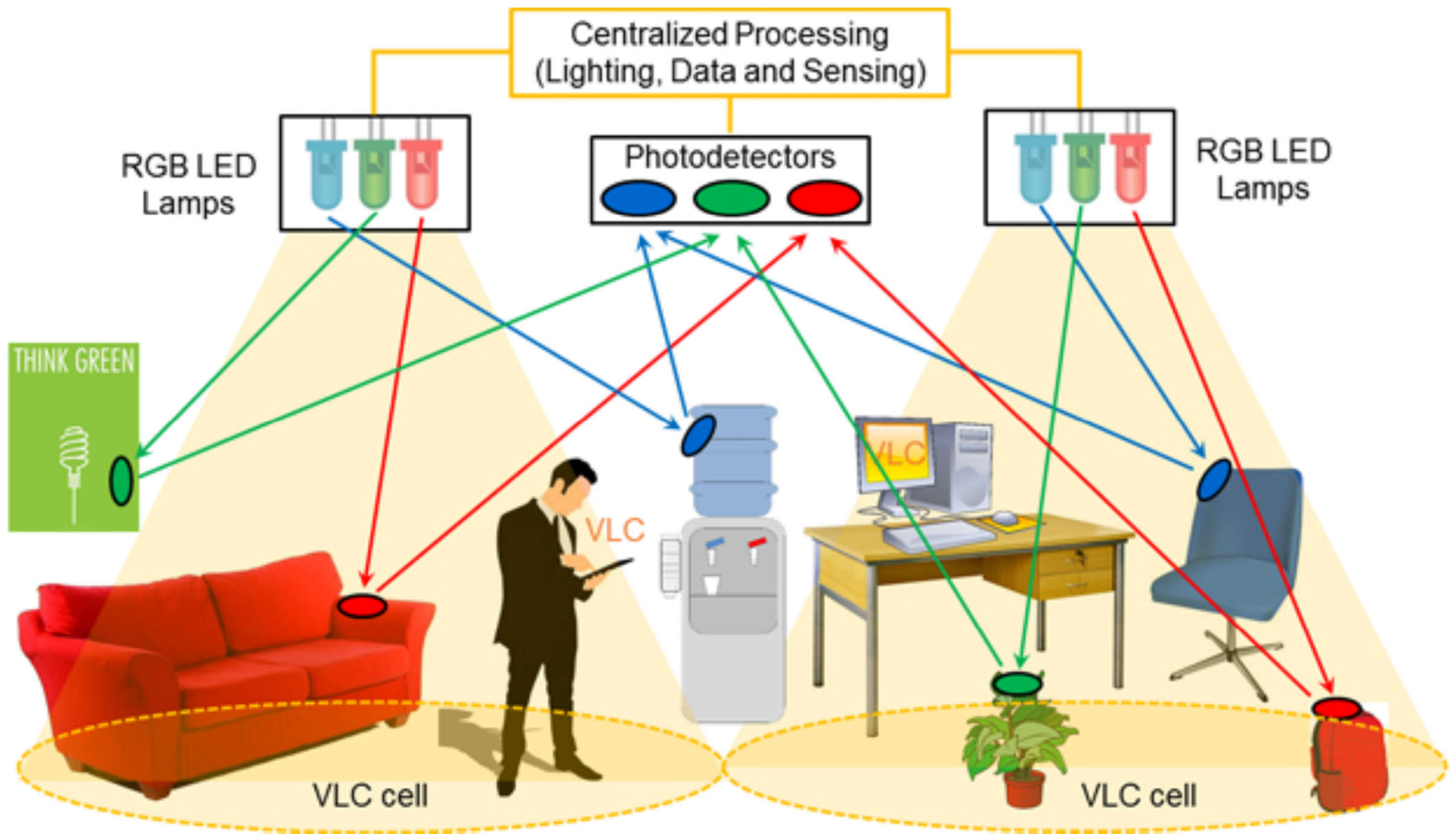

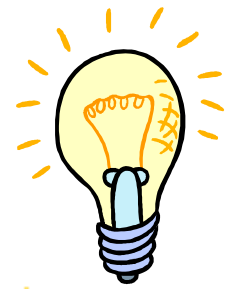

Further Reading

- Electrical ballast - Wikipedia
http://en.wikipedia.org/wiki/Electrical_ballast
- Introduction to Lighting Controls
<https://lightingcontrolsassociation.org/2017/07/21/introduction-to-lighting-controls/>
- Introduction to Wireless Lighting Controls
<https://lightingcontrolsassociation.org/2018/03/23/introduction-to-wireless-lighting-controls/>