



Outdoor Lighting Design

Ir Dr. Sam C. M. Hui

E-mail: sam.cmhui@gmail.com

<http://ibse.hk/cmhui/>



Contents

- Basic principles
- Common types
- Design considerations
- Light pollution



Basic principles



- Importance of outdoor (exterior) lighting
 - Extend the use of an area or activity at night
 - Contribute to a real & perceived sense of security
 - Enhance the night-time experience for people
 - Create focal points & a heightened sense of place
 - Can be used as a means to guide people
- General design aspects
 - Create a safe & pleasant environment
 - Appropriate use of energy, ease of maintenance
 - Harmonise with the surroundings

Examples of outdoor lighting applications

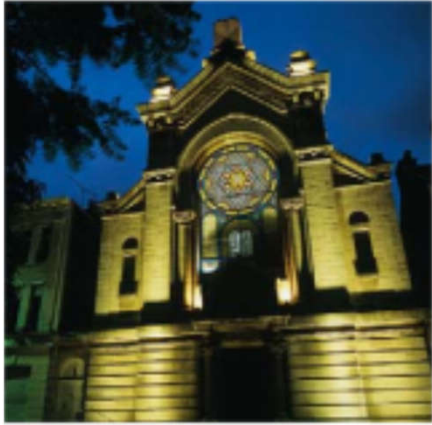

Façade lighting



Façade lighting



Façade lighting



Carpark lighting



Golf course lighting



Stadium lighting



Racecourse lighting

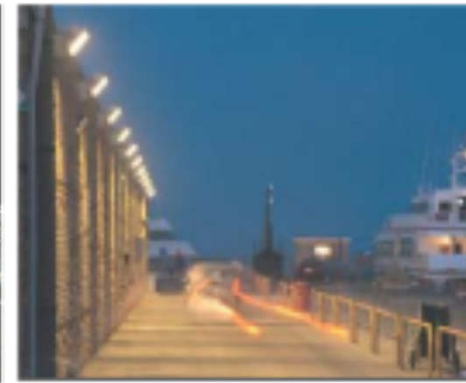

Wharf lighting



Petrochemical plant lighting

Basic principles



- Key factors for outdoor lighting design
 - Visual comfort
 - Sense of place
 - Spatial legibility
 - Way finding
 - Personal safety & security
 - A psychologically comfortable balance between lit & unlit spaces
- Practical issues: brightness, direction, context, energy efficiency, maintenance & first costs



Basic principles



- General lighting design objectives
 - Safety, performance & appearance
- Design criteria
 - Illuminance & uniformity
 - Direction of lighting & modelling
 - Maintenance concern
 - Atmospheric losses (airborne moisture & particles)
 - Disability & discomfort glare
 - Light source colour
 - Stroboscopic effects (fluctuation/ripple)



Components of effective visibility in night time environments

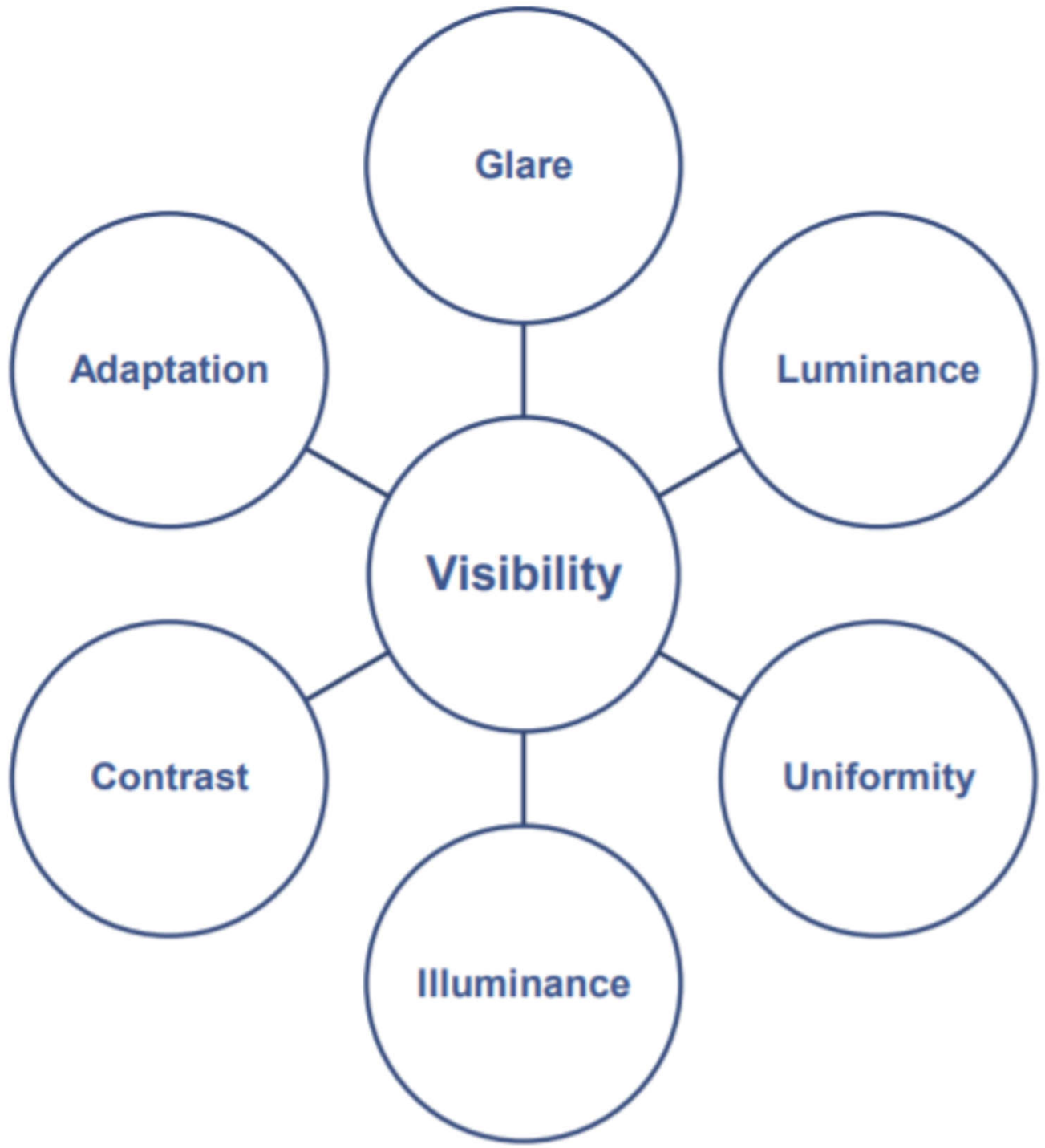

Illuminance range recommended for exterior lighting

Illuminance range (lux)	Critical plane	Application
1-10	Horizontal Vertical	Amenity, general storage areas Security, casual sports training
10-50	Horizontal	Stock & cargo handling, non-critical working areas car parks (high risk 50 lux)
50-100	Horizontal Vertical	Critical work areas, sports practice, playgrounds Aircraft service areas, advertising – unlit roads
100-500	Horizontal Vertical	Club & tournament sports, sales areas Advertising – lit roads, spectator sports
500-1000	Vertical	Spectator sports
1000-2000	Vertical	Televised sports events

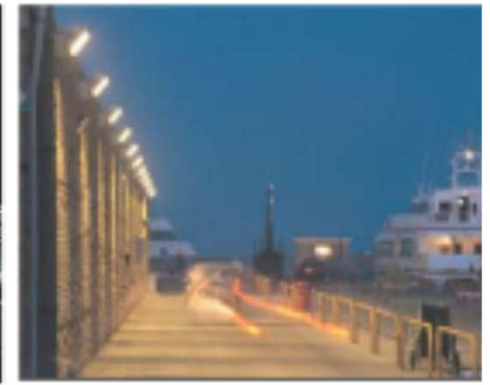
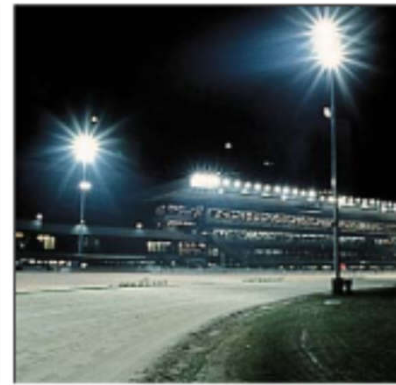
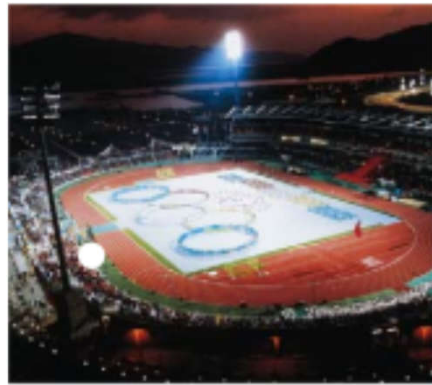

(Source: Thorn Lighting)

CIE recommended glare rating limits (GR_{max}) for area & sports lighting

Area Lighting

Type of application		GR_{max}
Lighting for		
Safety and Security	Low Risk	55
	Medium Risk	50
	High Risk	45
Movement and Safety	Pedestrian only	55
	Slow Moving Traffic	50
	Normal Traffic	45
Work	Very Rough	55
	Rough - Medium	50
	Fine	45

Sports Lighting

Type of application	GR_{max}
Lighting for Training Purposes	55
Lighting for Competition Purposes (including CTV broadcasting)	50



(See also: Calculations Glare Rating Concepts

https://docs.agi32.com/AGi32/Content/adding_calculation_points/Calculations_Glare_Rating_Concepts.htm)

(Source: Thorn Lighting)

Basic principles



- Technical design aspects

- Visual brightness & contrast

- Can help to subtly indicate different areas, buildings and activities



- Light colour

- Both varying colour temperature of white light & saturated coloured light (e.g. to make key structures & spaces more easily recognisable)



- Colour rendering (for the benefit of pedestrians)

- Luminaires (light distribution & direction, visual appearance, maintenance over time)



Basic principles



- Photometric data of flood light

- 1. Peak intensity
- 2. Beam spread
- 3. Beam efficiency
- 4. Luminous intensity
- 5. Half plane divergence

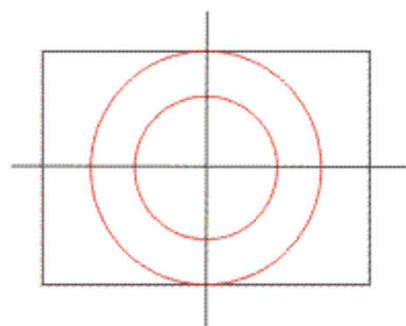
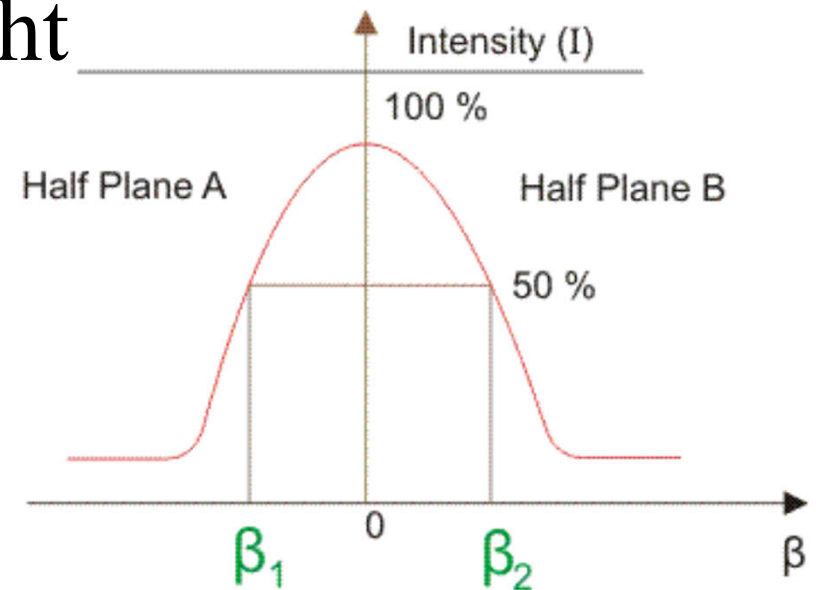

Rotational Symmetry

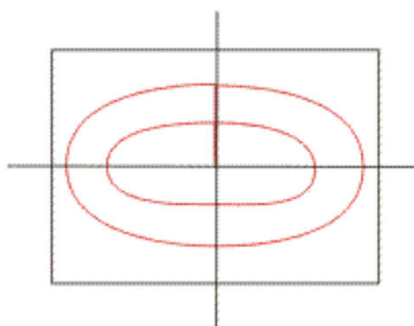

Symmetry above two plane

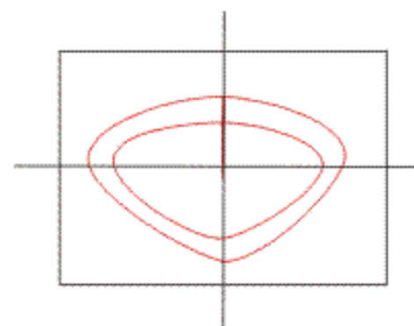

Symmetry about single plane

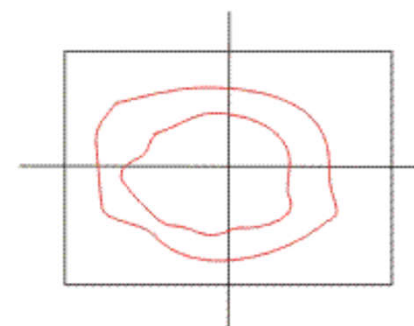

Asymmetry

Basic principles



- Outdoor lighting using floodlighting (1/2)
 - Floodlighting: flooding a surface with light
 - Achieve illumination on vertical or horizontal surfaces
 - Design issues
 - Appearance during daytime
 - Glare from the installation
 - Decorative lighting
 - Lighting for specific outdoor activities e.g. sports
 - Applications:
 - Building façade, sports, road lighting



Legislative Council Building (now Court of Final Appeal) in Hong Kong at daytime & night-time

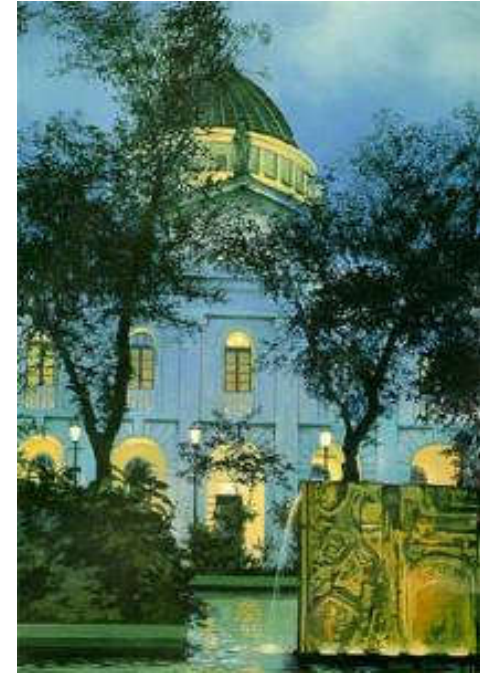
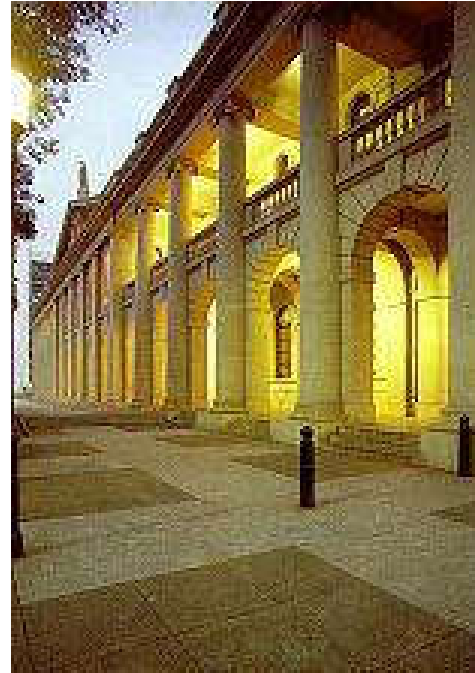

Basic principles



- Outdoor lighting using floodlighting (2/2)
 - Floodlighting a building
 - Requires a sense of drama & colour
 - Select locations for putting floodlights & aiming points
 - Peak intensity & beam angle
 - Usually all the beams from each floodlight shall overlap
 - Uniformity ratio (max : average) about 5:1
 - Floodlighting a horizontal open area
 - Use isolux diagram (horizontal illumination plots)
 - Or isocandela & zonal flux diagram
 - Calculate using inverse square law & cosine law

Floodlight design data

Floodlight Data

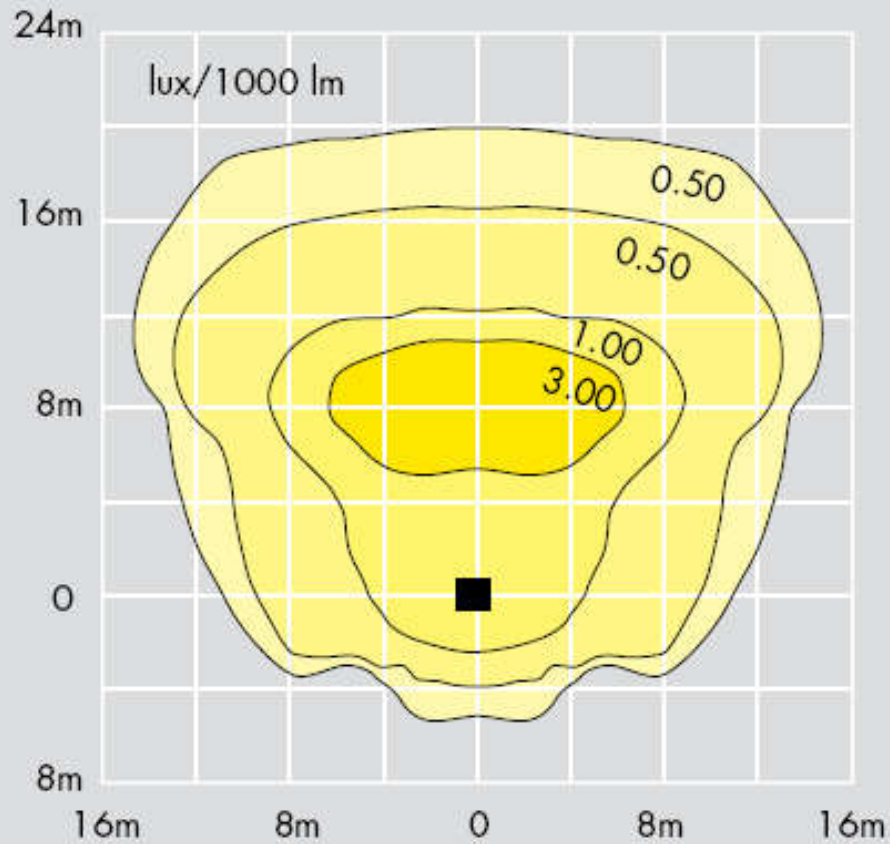

Cat. No. AFSS250.T
Fixed attitude - top horizontal
Mounting height: 8m

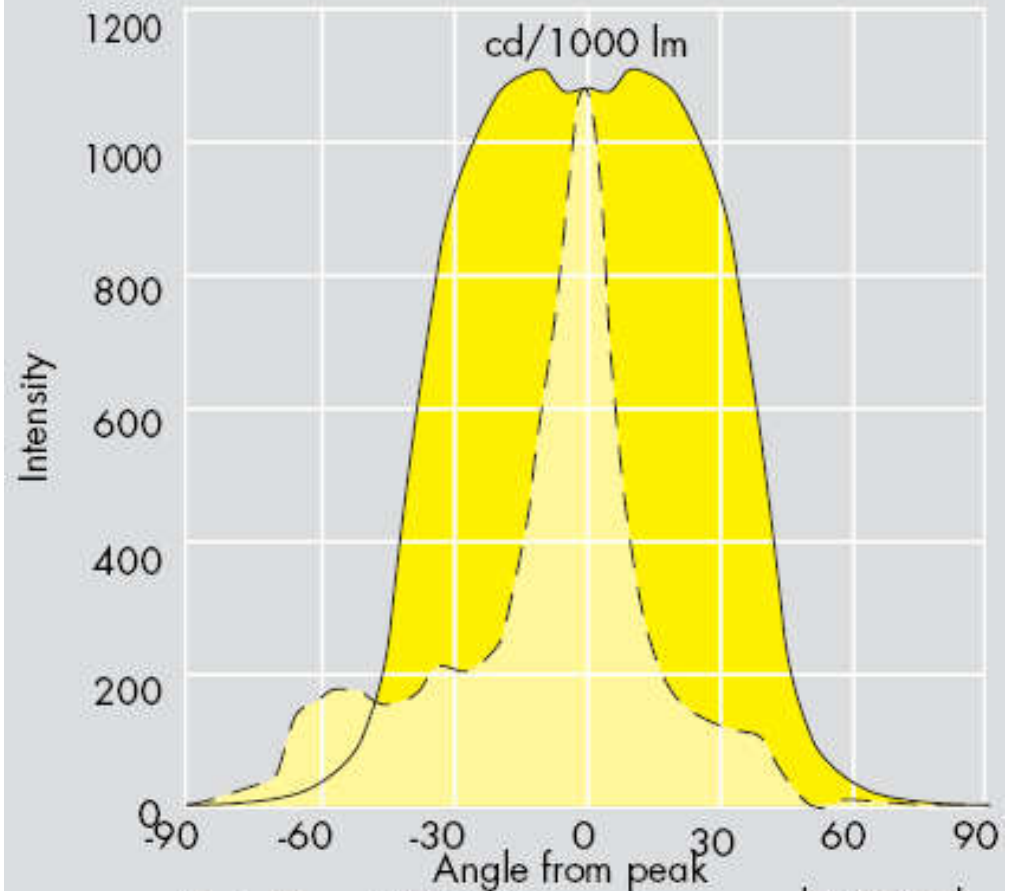

Cat. No. AFSS250.T
Lamp: 250W HPS-T(HO)

— horizontal
--- vertical

Sample floodlight design for a tennis court

Troika

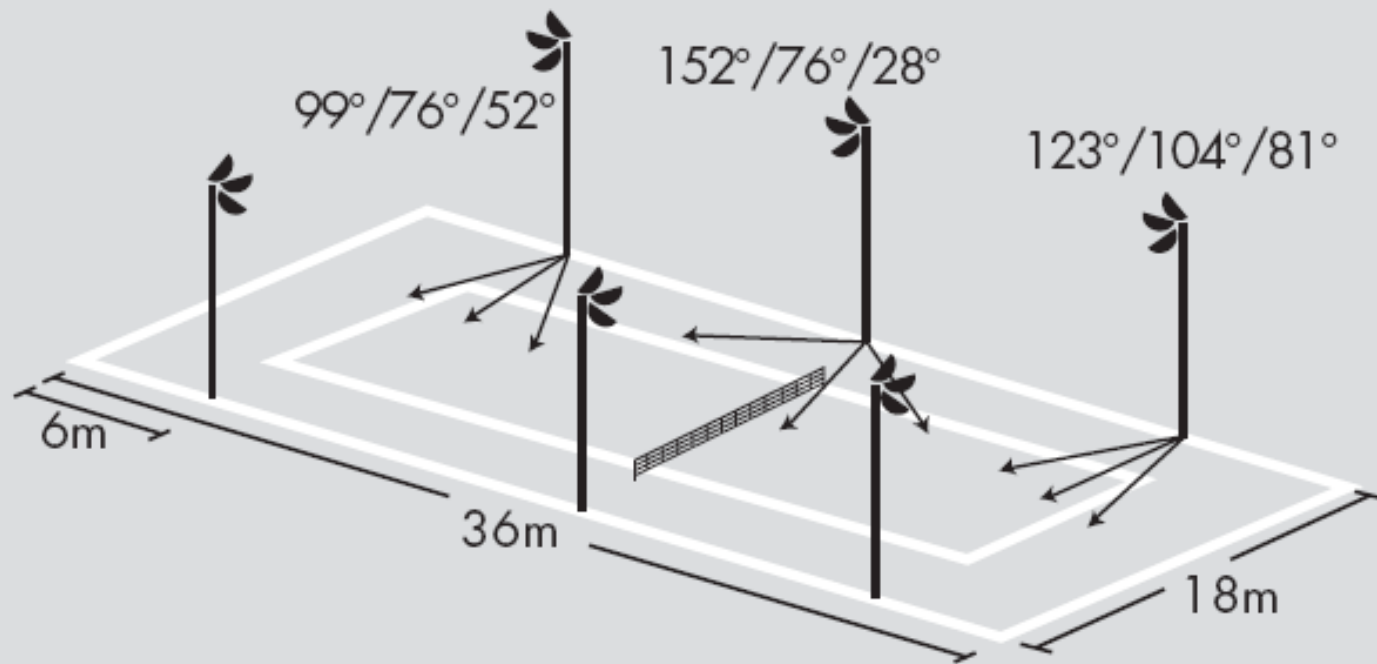

Class 2 Competition
Mounting height: 8m
Maintenance factor: 0.8

Cat. No: QTKA2540MSE40
+ CON2HQT-T400.4

Lamp: 18 x HIT 400W

Lumens: 38000

Lux: 300 avg

Lamp position: 1

Uniformity: 0.8

Glare rating: 41

Aiming angles given

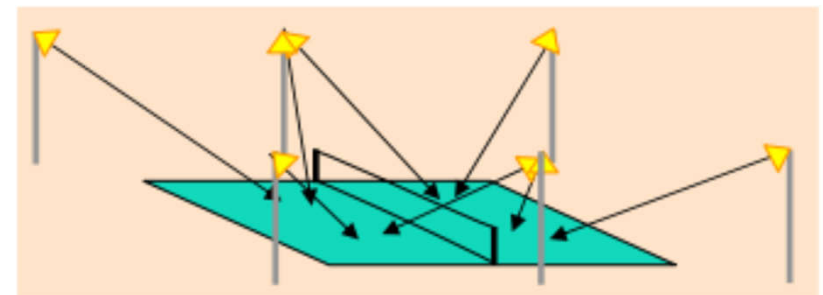

(Source: Thorn Lighting)

Isocandela and zonal flux diagram

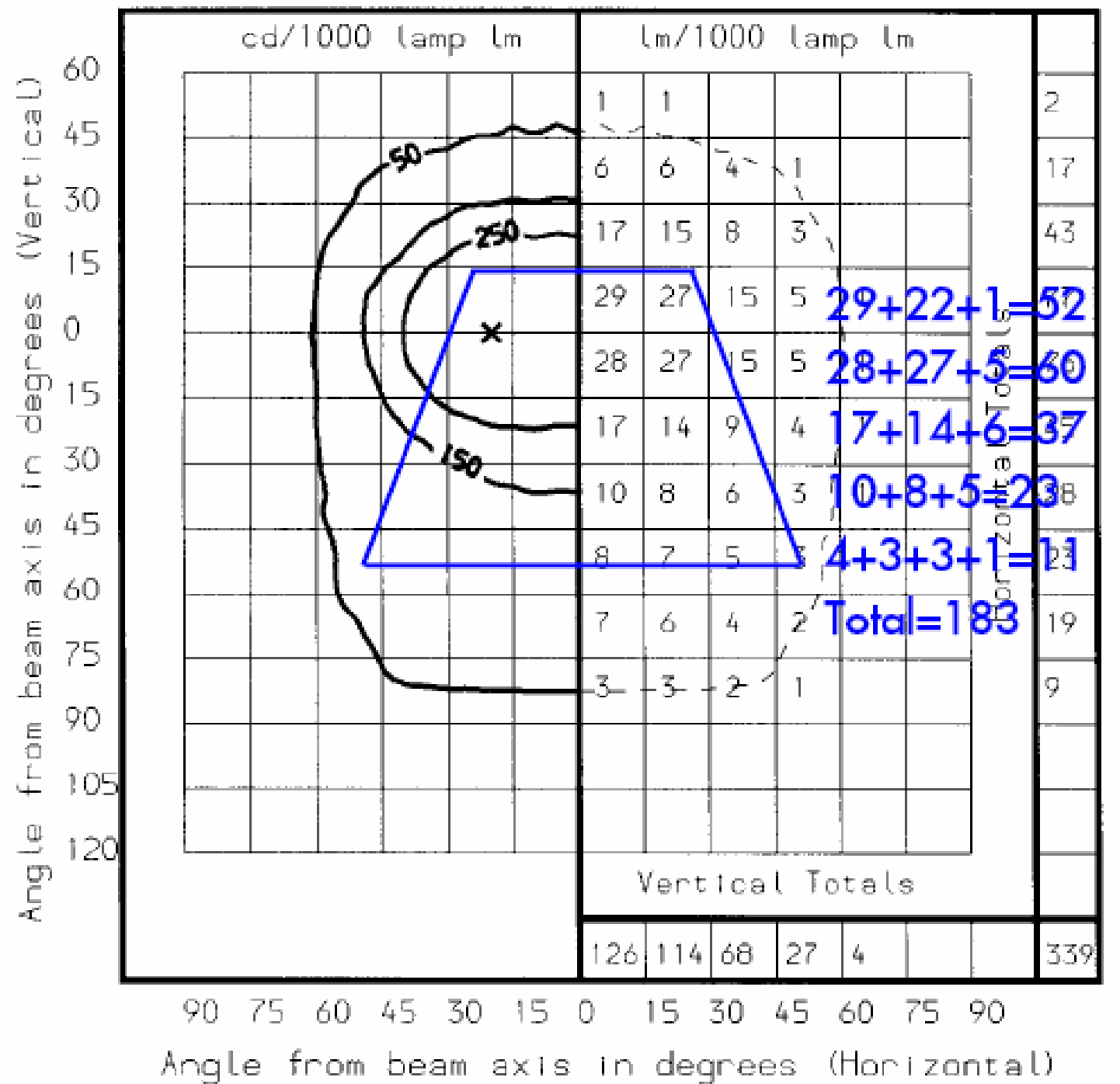

Basic principles



- Light for outdoors: Public & Outdoor – light for outdoor areas in public spaces

- <https://www.ercos.com/en/projects/public/>

- Illuminating trees correctly

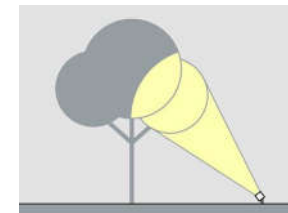

- Correctly illuminating facades

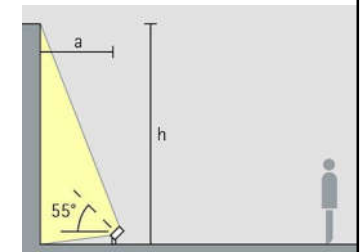

- Correctly illuminating paths

- Correctly illuminating art in outdoor spaces

- Correctly illuminating railway stations & stops

- Correctly illuminating bridges

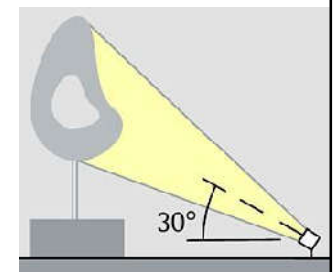

The Brandenburg Gate, the symbol of Berlin, Germany

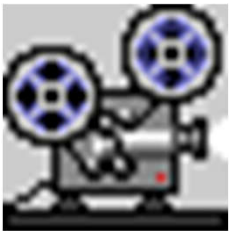

Video, photos & images of the project (from the lighting designer)

<https://www.kardorff.de/en/project/brandenburg-gate>

Common types



- Common types of outdoor lighting:
 - Area lighting (e.g. car parks, storage yards)
 - Amenity lighting (e.g. public areas, squares)
 - Landscape lighting (e.g. parks, gardens)
 - Facade lighting (e.g. buildings, structures)
 - Security lighting (to make natural surveillance)
 - Roadway lighting (private/public roads, highways)
 - Video walls (streaming onto building facades)
 - Digital advertising signs (with moving images)

Common types



- Area lighting



- To illuminate specific or large spaces e.g. outdoor parking, loading, storage & fabricating areas
- Consider whether stacked materials or heavy machinery will interfere with light distribution, or whether work activities will obstruct or block some of the light distribution
- Floodlights mounted on poles or high structures
- Luminaire locations, spacing & mounting heights

Typical floodlight aiming for an area $6H$ wide from both sides

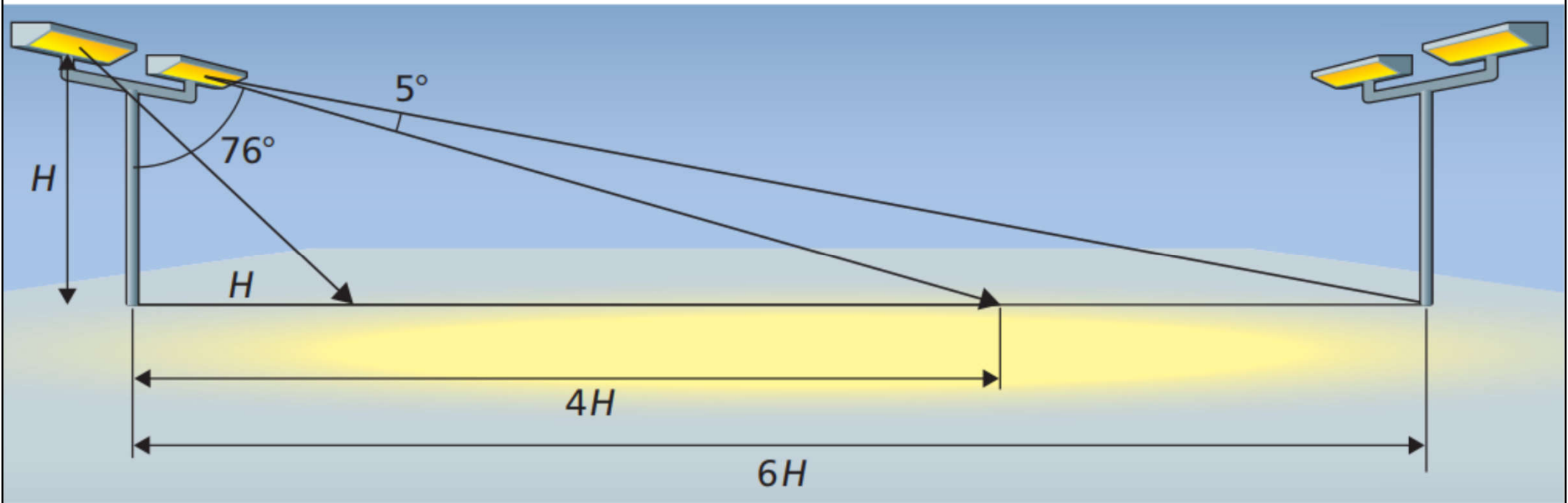

Column spacing with spacing to height ratio (SHR) equal to 2

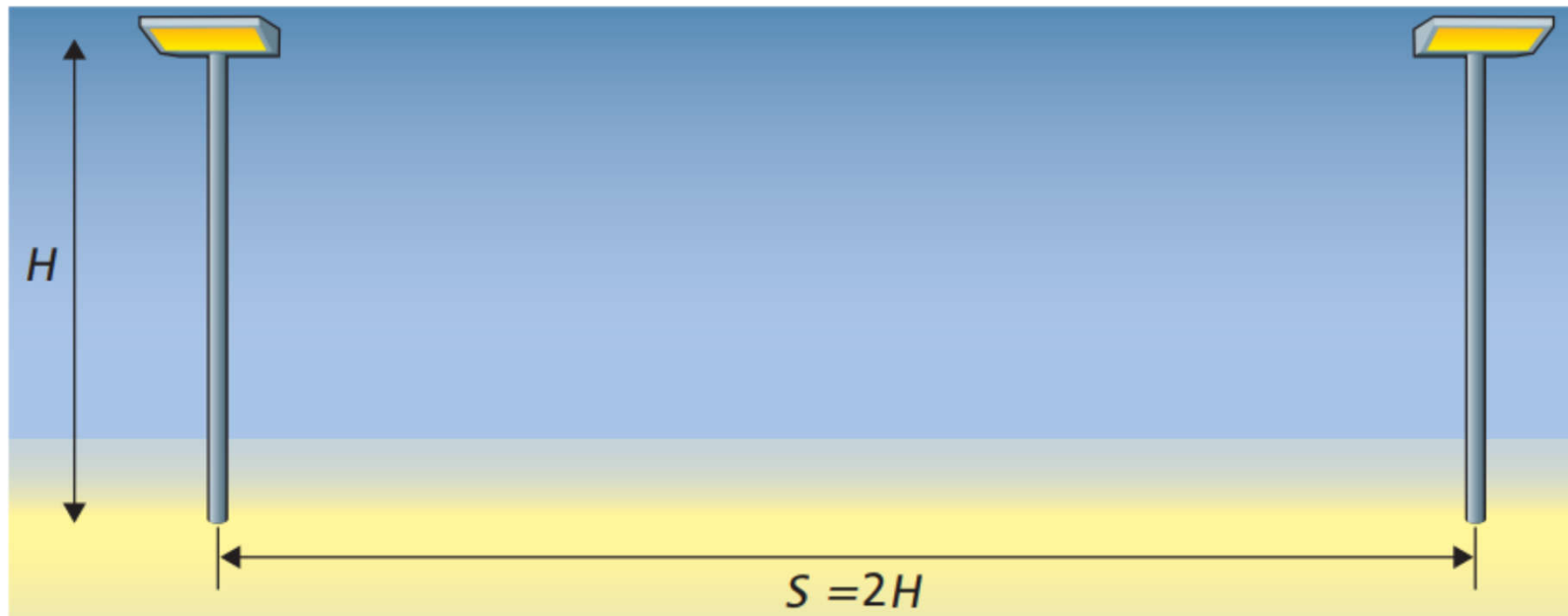

Common types



- Amenity lighting (urban lighting)
 - Lighting urban cities, towns & communities at night can create an attractive nightscape & make places safer to live in
 - Design aspects:
 - Safety & security
 - Promotion (commerce & tourism) & heritage
 - Ambience (feeling of invitation, warmth & intimacy)
 - Amenity (reveal footpath & illuminate pedestrians)
 - Identity (character) & spectacle (enjoyment)
 - Orientation (by lighting roads & landmarks)



Xinghai Square, Dalian (星海廣場, 大連市)



Common types



- Landscape lighting design method
 - Satisfy the client's need (e.g. highlight key elements, outdoor activities, security, energy use)
 - Scene & special effects for visual hierarchy
 - Basic stages & principles:



- Survey (to fully understand the site & context, functional, visual & creativity requirements)
- Analysis (set a performance brief with the basic criteria)
- Design (for safety, psychological & aesthetic needs)
- Appraisal (evaluate trial proposals & design solutions)
- Installation & commissioning/focusing



Context, colour & materials for exterior architectural lighting

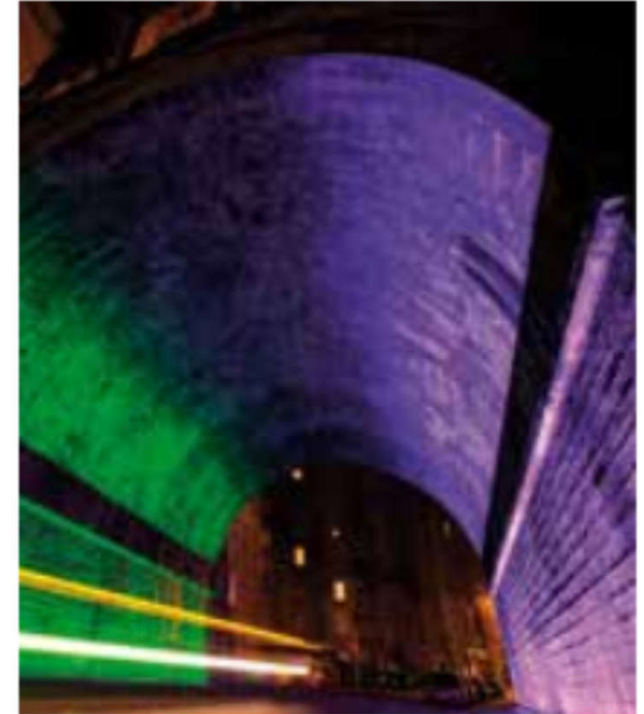
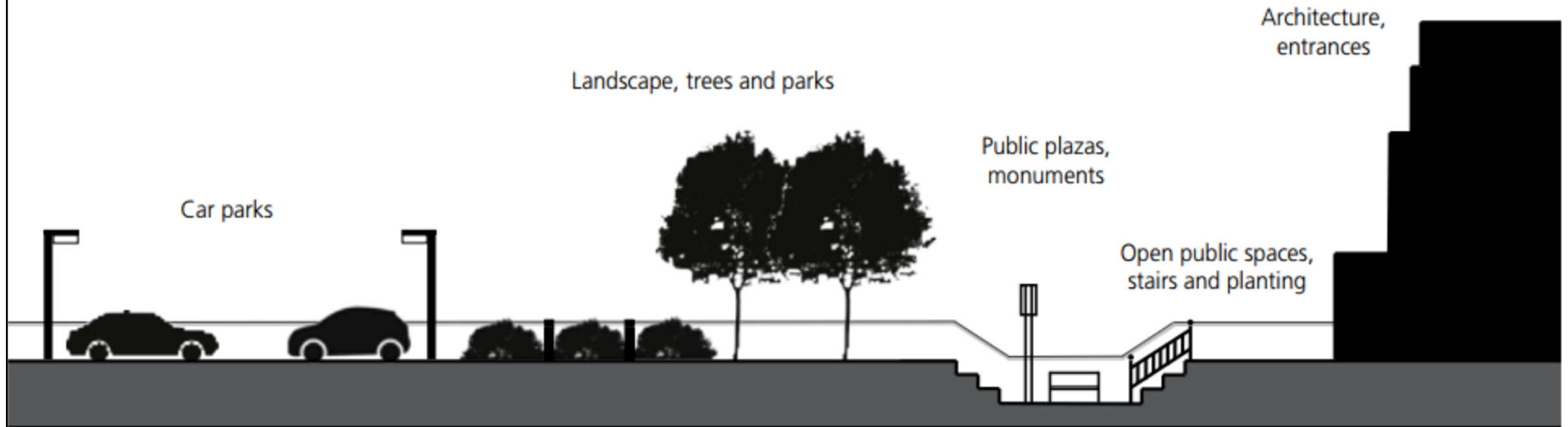

Outdoor lighting for the Megabox sculpture, Hong Kong



(Source: <https://www.erco.com/en/projects/public/megabox-sculpture-hong-kong-7031/>)

Common types



- Façade lighting
 - Illuminate building façades using floodlighting
 - To reveal specific buildings & highlight particular characteristics (e.g. for historic buildings)
 - Design considerations:

- Architectural character & features

- Degree of detailing
- Vertical characteristics
- Horizontal characteristics
- External recesses

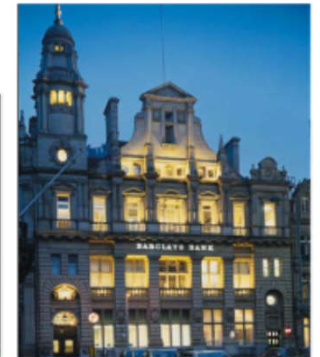
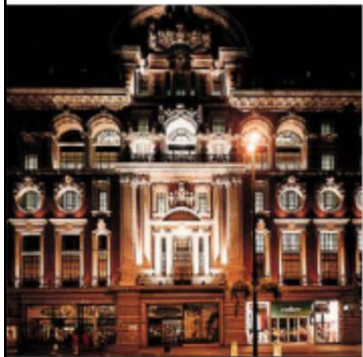

- Viewpoints (viewing positions & vantage point)
- Techniques (spotlights, modelling, silhouette, contrast)

Design stages of façade lighting

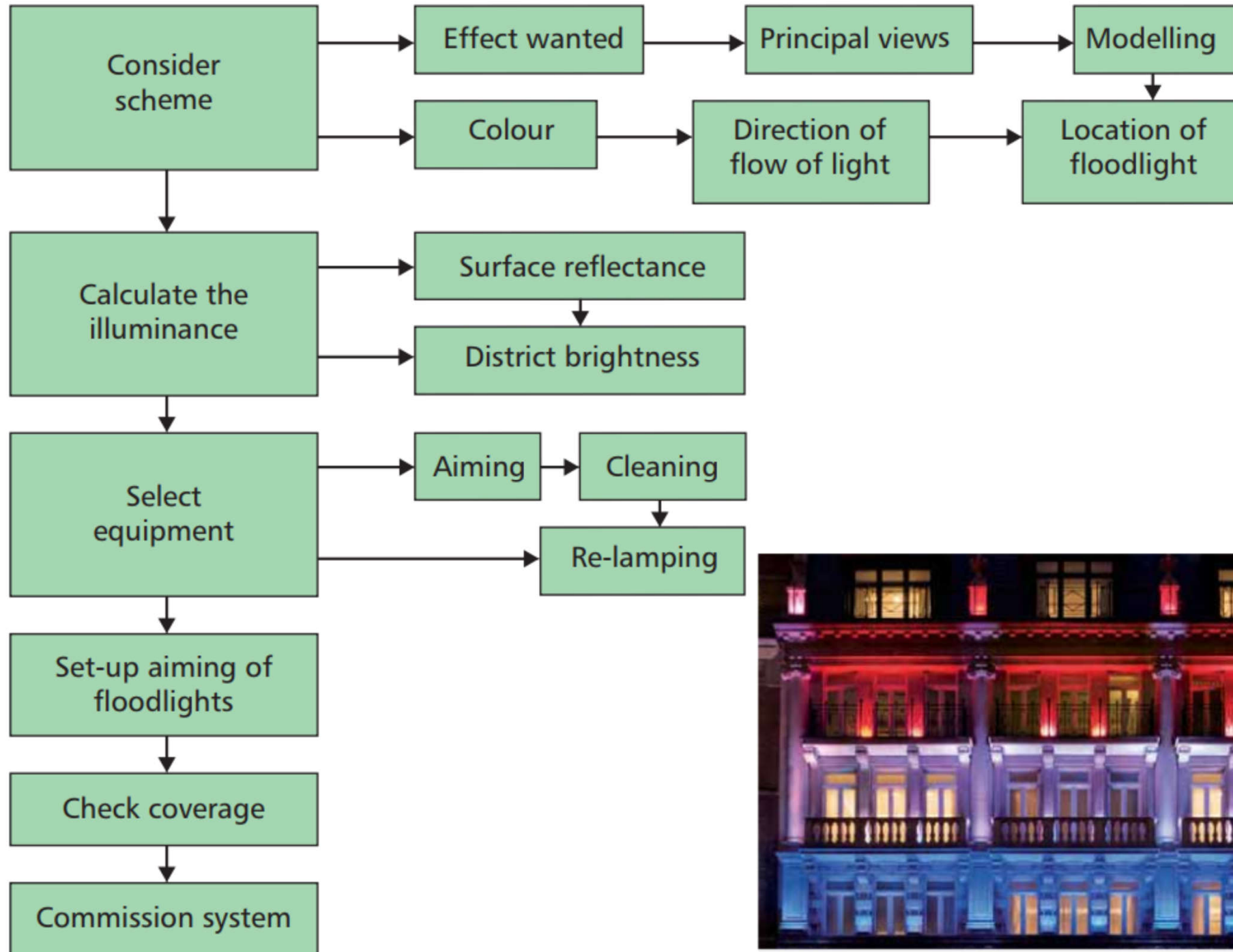

Façades of Milan Cathedral illuminated by high-output projectors



ERCO - Milan Cathedral (3:36) <https://youtu.be/XJGwspr6BkE>

(Source: <https://www.erco.com/en/projects/contemplation/milan-cathedral-6965/>)

Illumination of the projecting roof for Gyeongbokgung Palace, Seoul



(Source: <https://www.erco.com/en/projects/public/gyeongbokgung-palace-seoul-7296/>)

Common types



- Correctly illuminating façades
 - <https://www.ereco.com/en/projects/public/correctly-illuminating-facades-7226/>
 - From accenting to floodlighting: find the right light distribution
 - Uniformly illuminating an entire façade
 - Modelling the facade structure with grazing light
 - Correct use of light colours & contrasts
 - Pay attention to the correct handling of light
 - Ground, building or mast – from where do you want to illuminate?

Common types



- Roadway lighting: five main criteria
 - 1. Average illuminance on the road surface
 - 2. Illuminance on areas adjoining the carriage-way
 - 3. Uniformity of the illuminance pattern
 - 4. Degree of glare restriction
 - 5. Colour of the light
- Driving task analysis
 - A collection of observations & decisions a car driver has to make (to avoid hazards)
 - Visual information & visual field



Road lighting terminology & road lantern arrangements

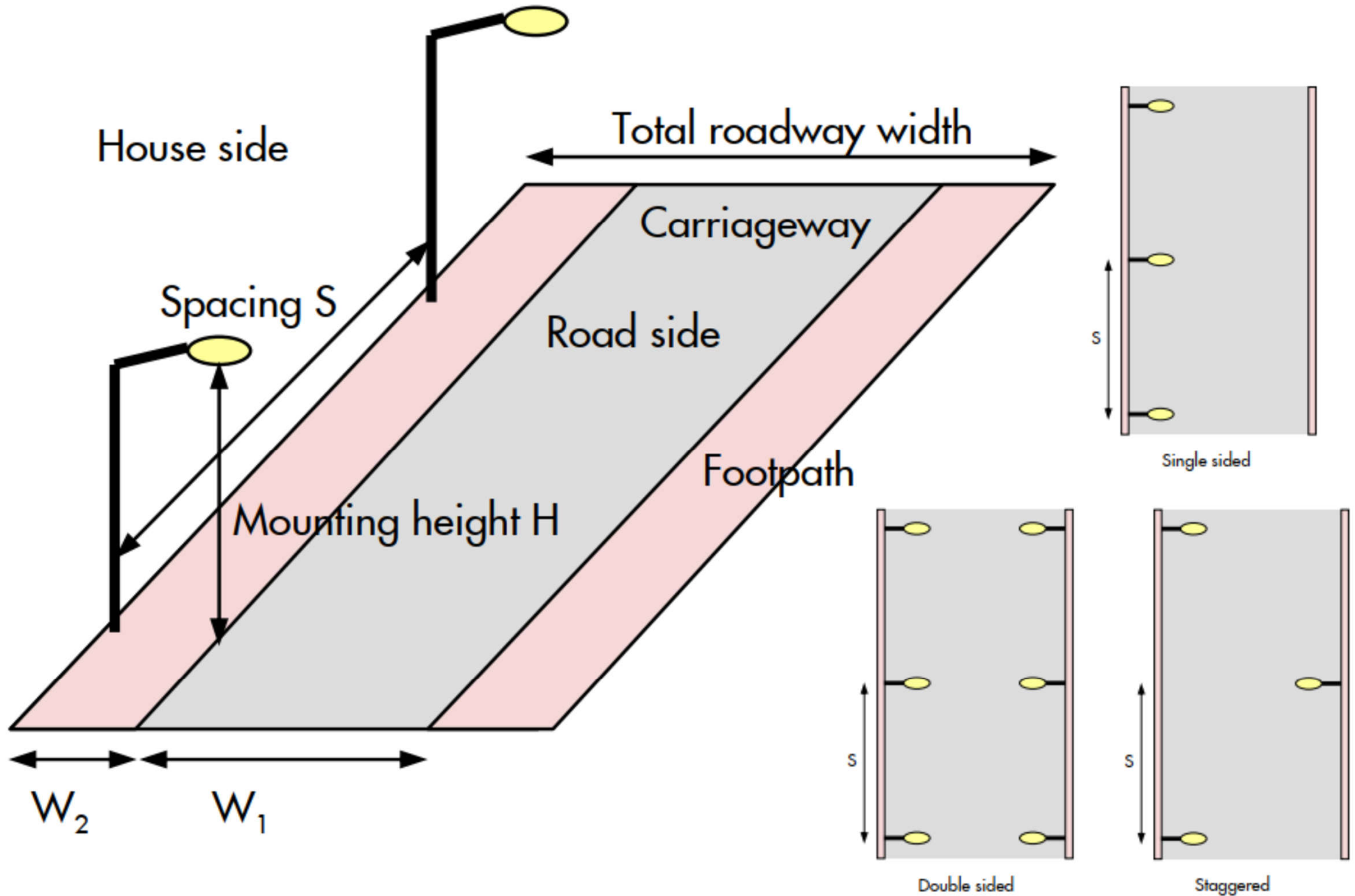

Lighting classes for conflict areas

In conflict areas, due to changes of road layout or high patronage by pedestrians, cyclists or other road users, the visual task is usually more difficult than on straight roads. A higher lighting level should be provided.

Lighting Class	Locations	Maintained Average Illuminance (lux)	Uniformity Ratio*
CE1	Toll plazas, large roundabouts, large interchanges and grade separated intersections	30.0	0.4
CE2	Small roundabouts, carparks, bus terminuses and taxi stations	20.0	0.4
CE3	Road junctions of urban roads	15.0	0.4
CE4	Road junctions of rural roads	10.0	0.4
CE5	Cul-de-sacs and small parking lots	7.5	0.4

Remarks * : Uniformity Ratio is the ratio of the minimum illuminance to average illuminance.

(Source: Public Lighting Design Manual (Highways Dept, HK)

https://www.hyd.gov.hk/en/publications_and_publicity/publications/technical_document/public_lighting_design_manual/)

Common types



- Video walls (large screens & projections)
 - Media architecture (for commercial purposes & advertising in public spaces)
 - Not only show pictures in motion, but can communicate with the surrounding environment & their occupants
 - Types of media architecture
 - Urban screens (w/ multimedia content, attached to building facades without any architectural integration)
 - Media facades (building facades integrate light sources)
 - Dynamically illuminated facades, connected to programmable control systems
 - Integration of multimedia systems on the façade (modular LED lighting systems)



Examples of urban screens & media architecture



(Source: SLL, 2016. *The Exterior Environment*, Lighting Guide 6, Society of Light and Lighting (SLL), London;

<https://www.illuminationphysics.com/projects/exterior/hsbc-facade/>)

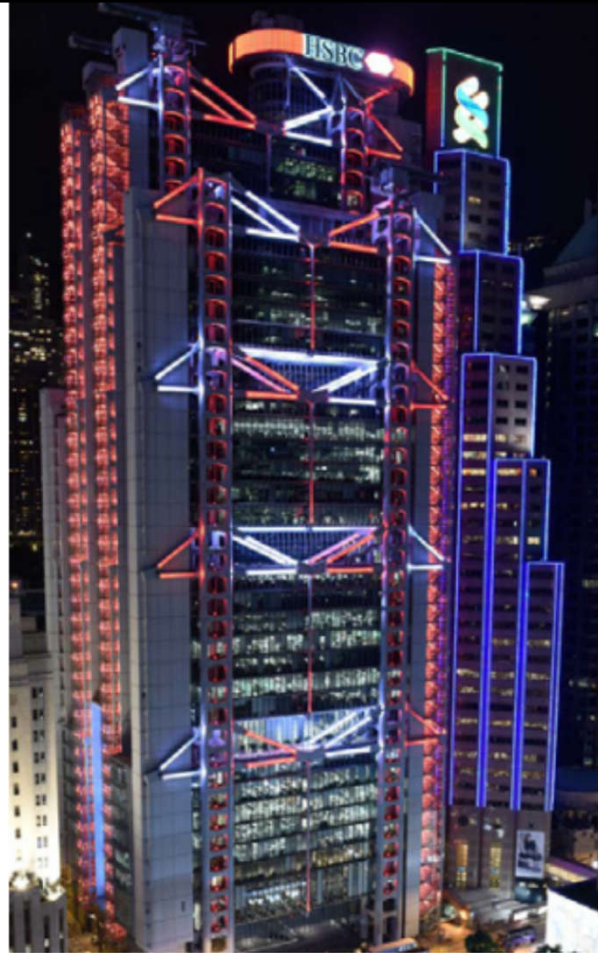

HSBC Digital Makeover HSBC's Headquarters - Hong Kong



Video: illumination Physics
presents HSBC Symphony
of Lights (from Central)
(14:36)

[https://youtu.be/mB8B0a-
aNWM](https://youtu.be/mB8B0a-aNWM)

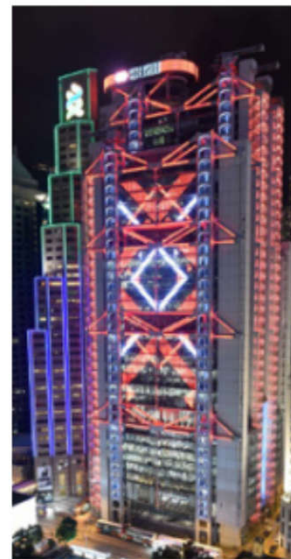
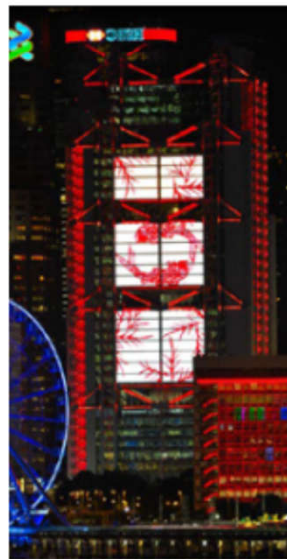
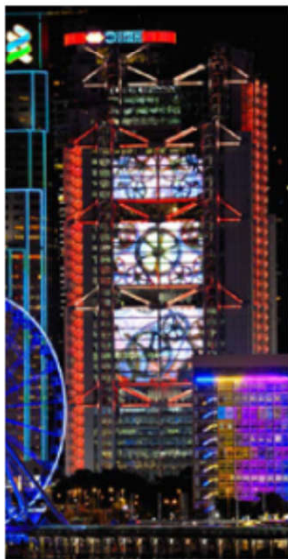



Design considerations

- Design factors to be considered:
 - Scale of the equipment (e.g. industry plants)
 - Nature of work (for safety, visual discrimination)
 - Need for good colour vision
 - Obstruction (to minimize shadows)
 - Interference with complementary activities (e.g. in railway yards, airports & docks)
 - Hours of operation (switching & safety issues)
 - Impact on the surrounding area (e.g. light trespass)
 - Atmospheric conditions (e.g. corrosive, flammable)

Typical lighting arrangement for pier served stand in airport terminal

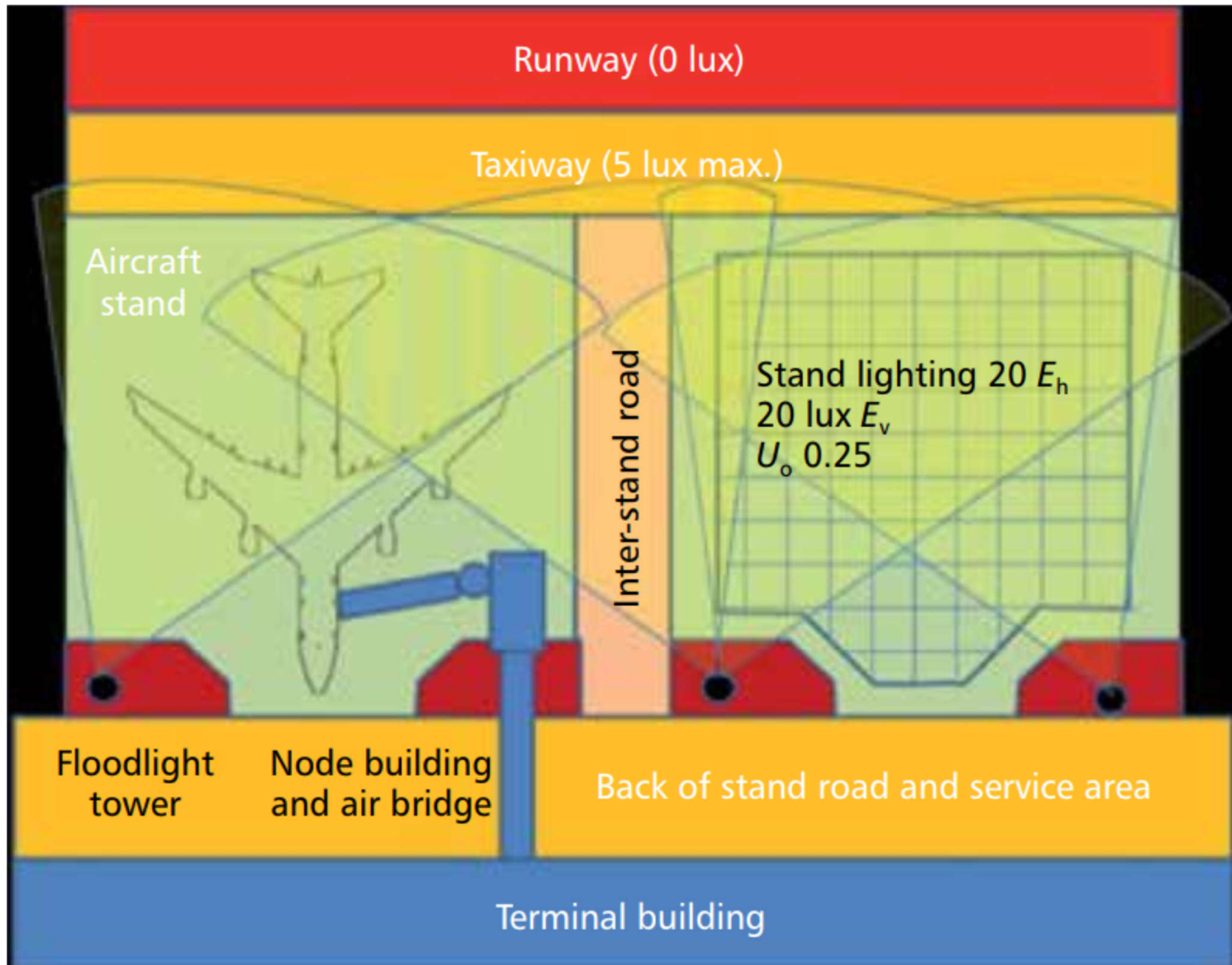

Design considerations





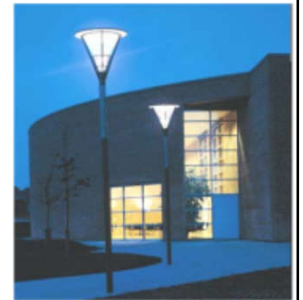

- Requirements of outdoor luminaires

- Weather protection (IP rating)
- Mechanical impact resistance
- Vandal resistance
- Luminaire efficiency & light distribution
- Design life of the installation & maintenance
- Daytime appearance of luminaires & columns
- Burning position, aiming direction, restrike time
- Protection for extreme conditions
 - Hot, cold & dry conditions; marine environments (salt)

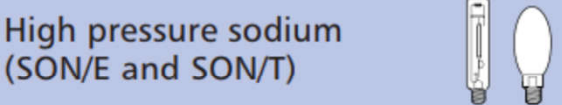

Performance characteristics of different lamp types

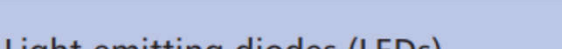
Lamp type	Efficiency (lumens per watt)								Average life (thousand hours)							Colour rendering	Colour temperature K		
	10	30	50	70	90	110	130	150	2	6	10	14	18	22	26			30	40+
Tungsten halogen 																		100 excellent	3000
Tubular fluorescent (triphosphor and multi-phosphor) 																		80-100 very good/excellent	2700-6500
Compact fluorescent 																		70-90 average/good	2700-6000
High pressure sodium (SON/E and SON/T) 																		20-39 very poor	2500
Metal halide 																		80-100 very good/excellent	3000-6000
Light emitting diodes (LEDs) 																		40-90 poor/excellent	3200-8000

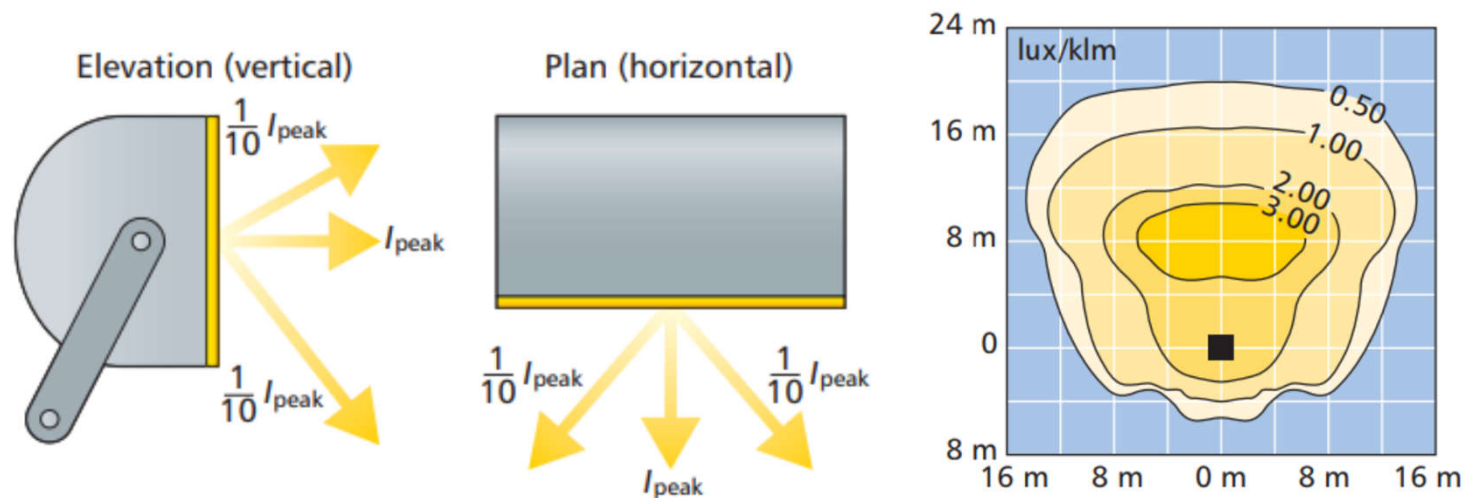

(Source: SLL, 2016. *The Exterior Environment*, Lighting Guide 6, Society of Light and Lighting (SLL), London.)

Outdoor luminaire classification system

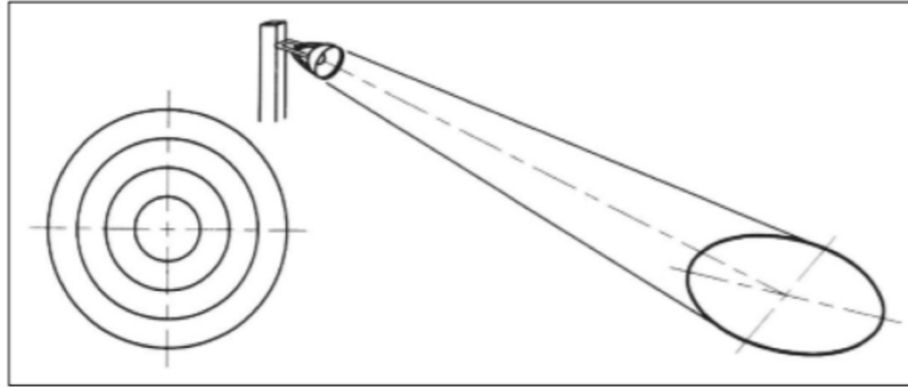
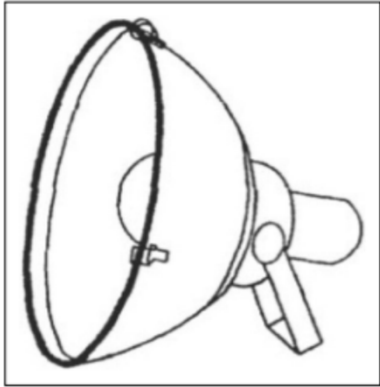

Type A flood light / projector producing a symmetrical beam

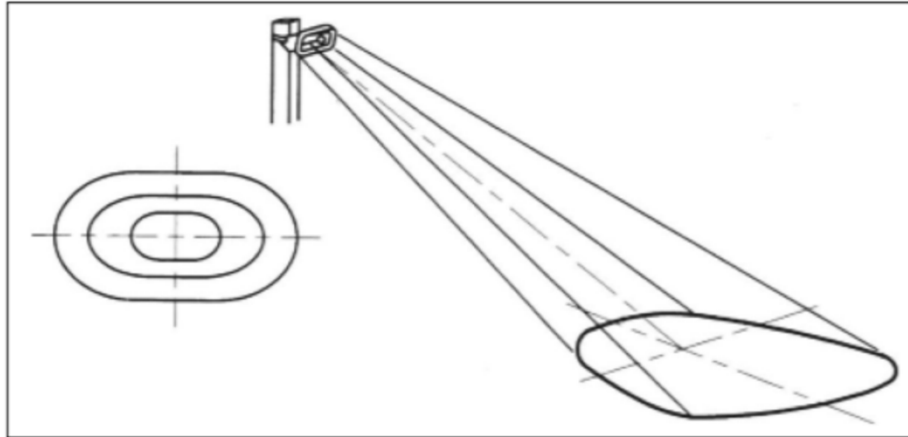
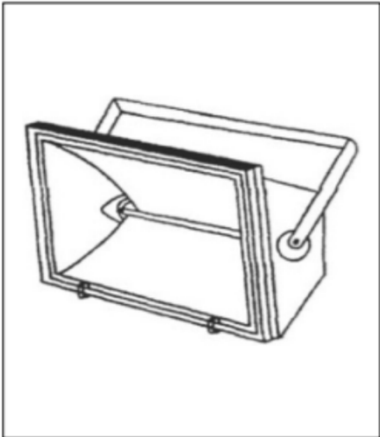

Type B flood light / projector producing a fan-shaped beam

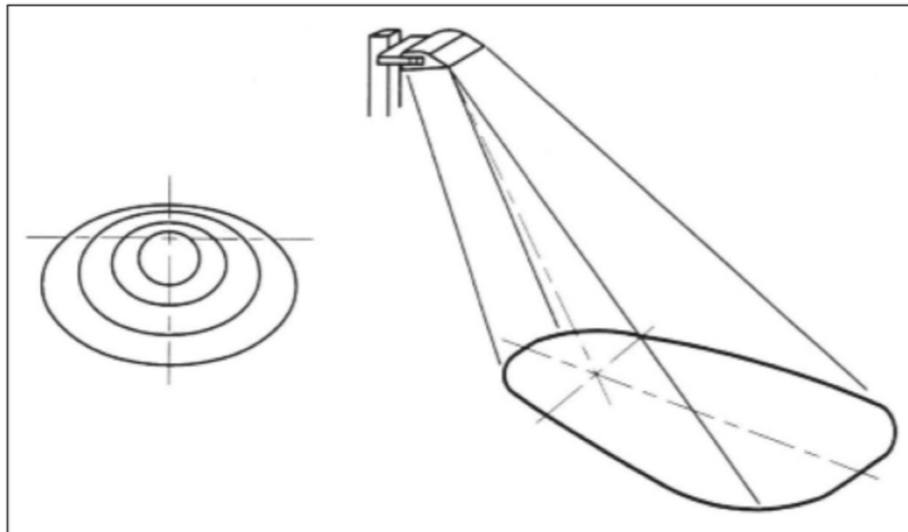
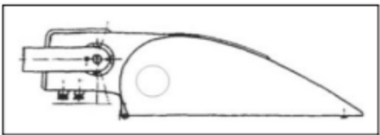

Type C flood light / projector producing a double asymmetric distribution in the vertical plane



Design considerations

- Installation methods
 - Surface mount (building)
 - Surface mount (ground)
 - Recessed mount
 - Pole mount
 - Backlit façades
 - Delineation (integrated into a façade)
- Ingress Protection (IP) rating, e.g.
 - IP65 = dustproof & protected against jets of water from all directions

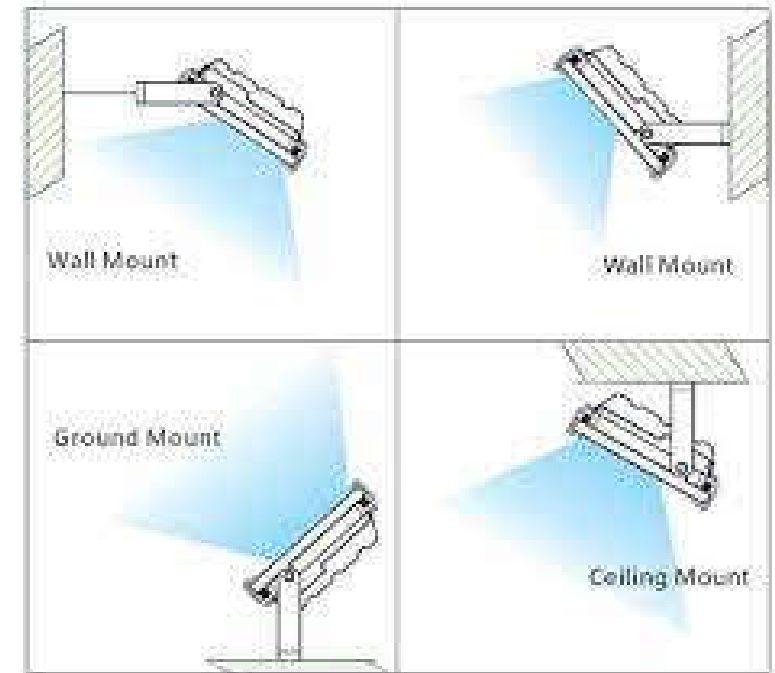

Ingress Protection (IP) number

Ingress Protection (IP) Chart

Solids

1 Protection against solid objects greater than 50 mm in diameter



2 Protection against solid objects greater than 12,5 mm in diameter



3 Protection against solid objects greater than 2,5mm in diameter



4 Protection against solid objects greater than 1 mm in diameter



5 Dust protection



6 Dustproof



Water

1 Have to protect against spraying liquids on the device from vertical angle



2 Have to protect against spraying liquids on the device from 0-15° angle



3 Have to protect against spraying liquids on the device from 0-60° angle



4 Have to protect against splashing liquids on the device from any direction



5 Have to protect against flushing liquids on the device from any direction



6 Have to protect against heavily flushing liquids on the device from any direction



7 Have to protect for less than 30 minutes of sinking into the water



8 Have to protect for continuously sinking into the water



IP65



Design considerations

- Maintenance issues
 - The lamp survival
 - The lamp lumen depreciation
 - Ease of access (e.g. extent of signing & coning)
 - Interference with traffic
 - The frequency of luminaire cleaning
- Maintenance programme includes lamp replacement, cleaning & fault clearance
- Economics: capital costs & operating costs

Design considerations



- Presentation of lighting concepts & ideas
 - Pencil & crayon sketches
 - Photoshop illustrations (photo-realistic renders)
 - 3D modelling (e.g. using SketchUp, 3ds Max)
 - Lighting visualization software (e.g. DIALux)
- Integration of renewable energy systems
 - Photovoltaic (PV) & wind power
 - Electrical storage using batteries
 - Standby period with storage power & the need to minimise electrical energy consumption

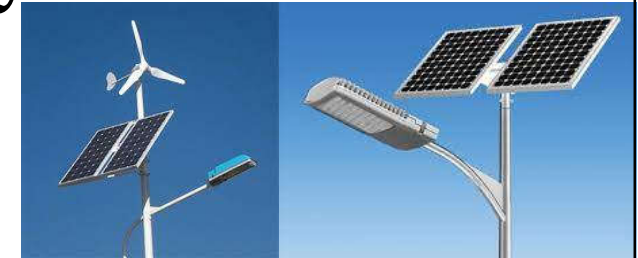

Architect's sketched image, night-time concept generated using Photoshop & 2D/3D modelling using DIALux

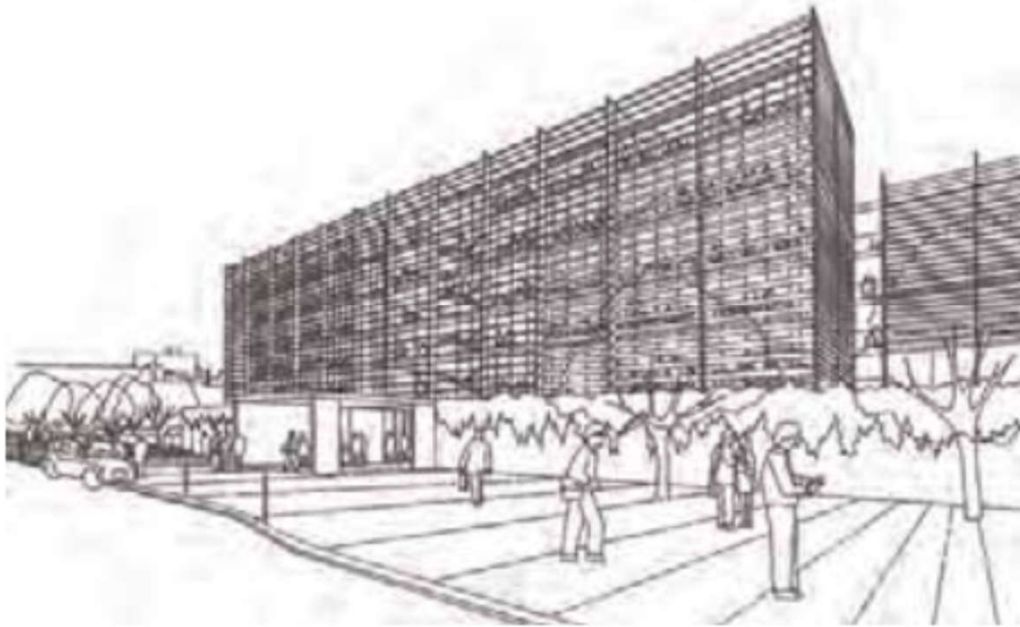

Light pollution

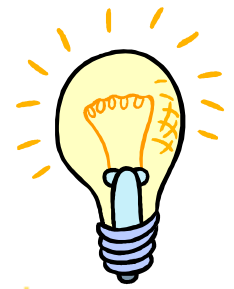

- Light pollution (Obtrusive light) 光害/光污染
 - Inappropriate or excessive use of artificial light
 - A side effect of industrial civilization. Its sources include building exterior & interior lighting, advertising, commercial properties, offices, factories, streetlights, and illuminated sporting venues
 - Can have serious environmental consequences for humans, wildlife & our climate
 - Outdoor lighting at night are often over lit
 - Can present physiological & ecological problems (light nuisance)

Light pollution from external lighting



Light pollution



- External lighting causing light nuisance:
 - Shop signs & advertisement boards
 - Lighting for facades & features, video walls
 - Lighting for construction site (e.g. signboards)
 - Lighting for sports fields & playgrounds
 - Lighting outside buildings (not for facades & features)
 - Others (e.g. street lighting, lighting for school, car park, swimming pool, race course, golf range & cargo handling area)

Example of useful light & light pollution from a typical pole-mounted outdoor luminaire

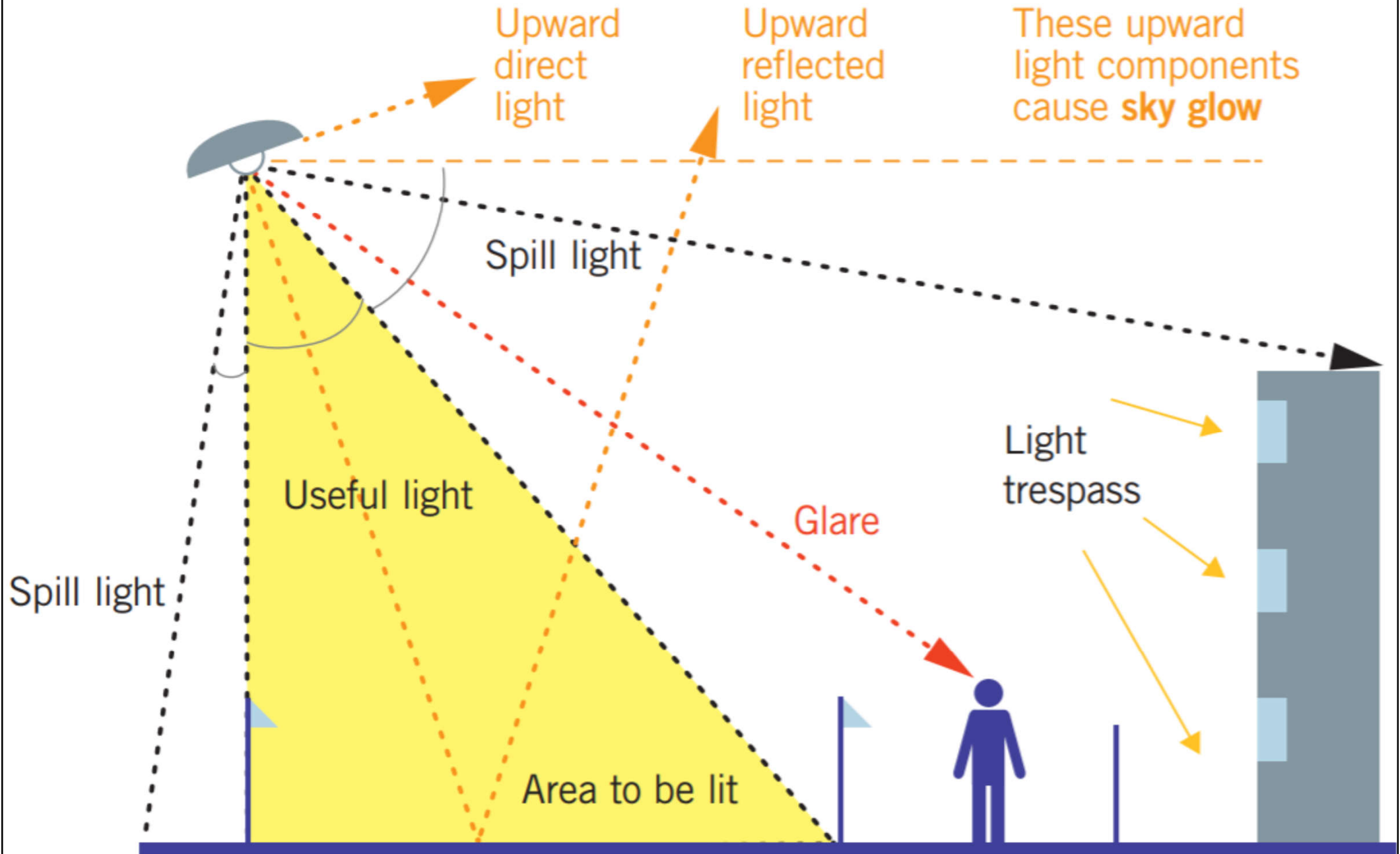

Comparison of sky appearance with & without light pollution

Before



After



(Source: <https://www.darksky.org/light-pollution/>)

Light pollution



- Components of light pollution:
 - 1. Glare – excessive brightness that causes visual discomfort (even blinding or disability)
 - 2. Skyglow – brightening of the night sky over inhabited areas
 - 3. Light trespass – light falling where it is not intended or needed (unwanted light)
 - 4. Clutter – bright, confusing & excessive groupings of light sources

Different components of light pollution & what good lighting looks like

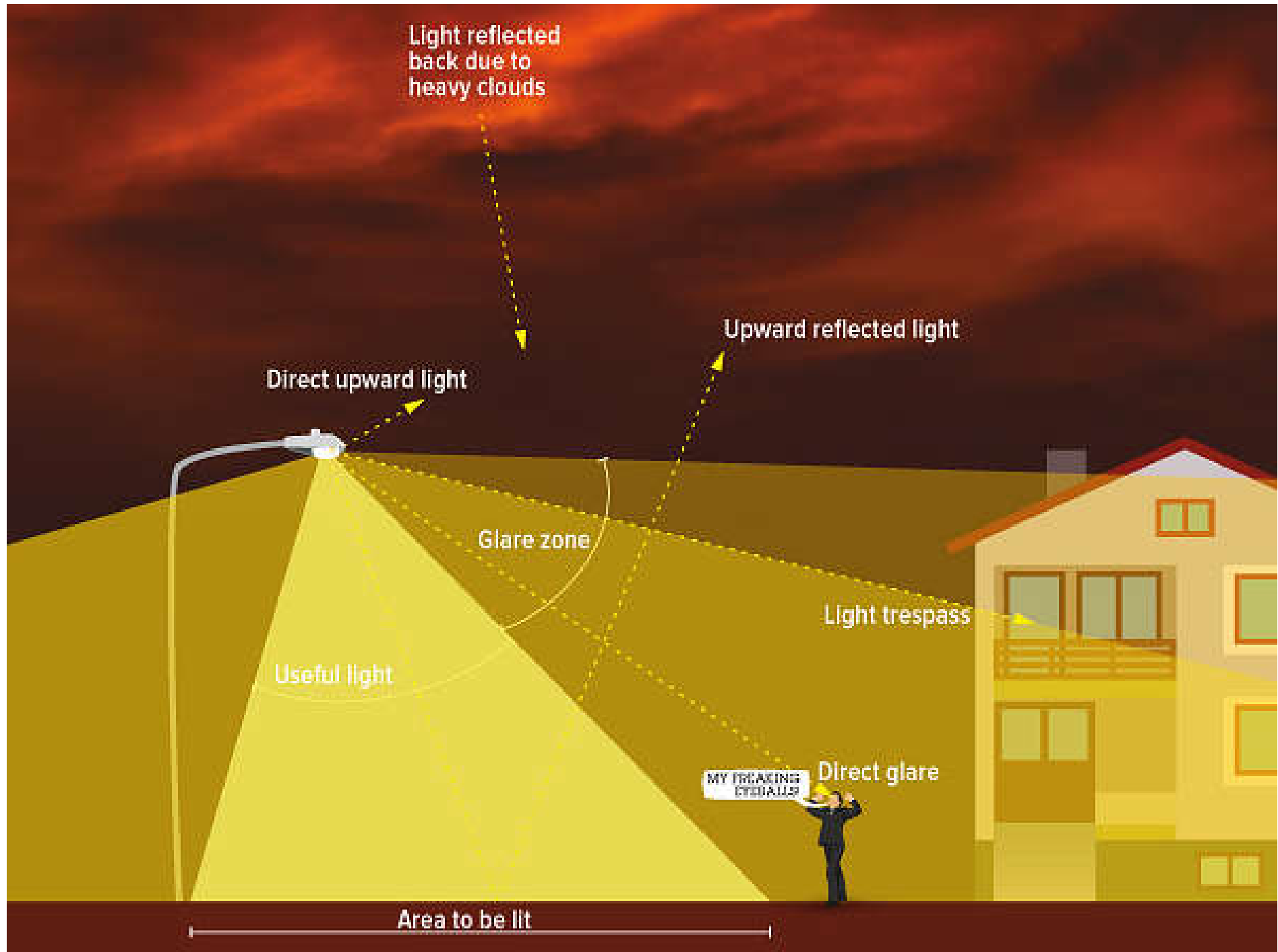

(Source: <https://www.darksky.org/light-pollution/>)

Light pollution

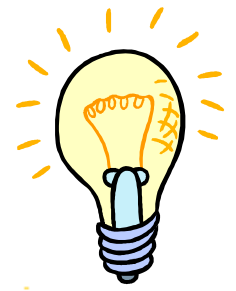

- Negative impacts of light pollution:
 - Increasing energy consumption
 - Disrupting the ecosystem & wildlife
 - Harming human health
 - Affecting crime & safety



Common types of obtrusive light (or light pollution)

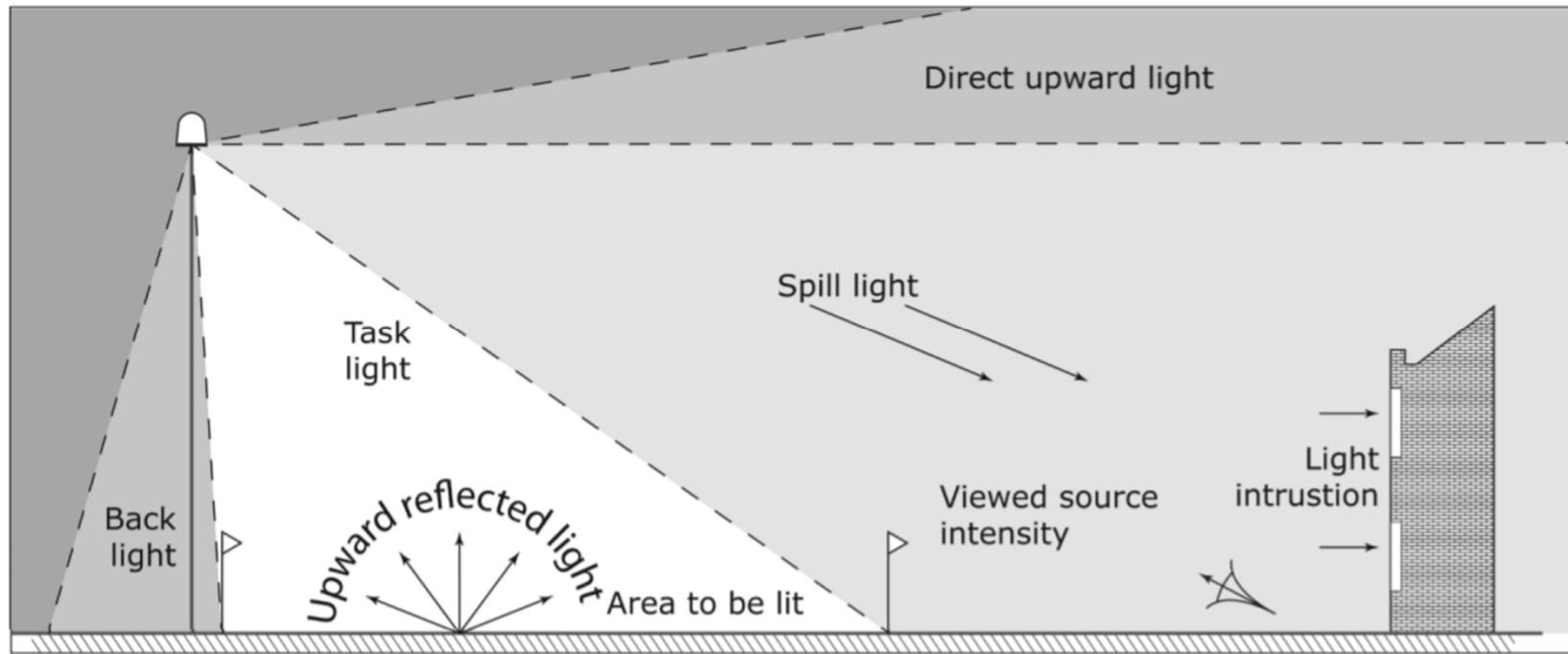

The effect on the ability to view the night sky at various angles

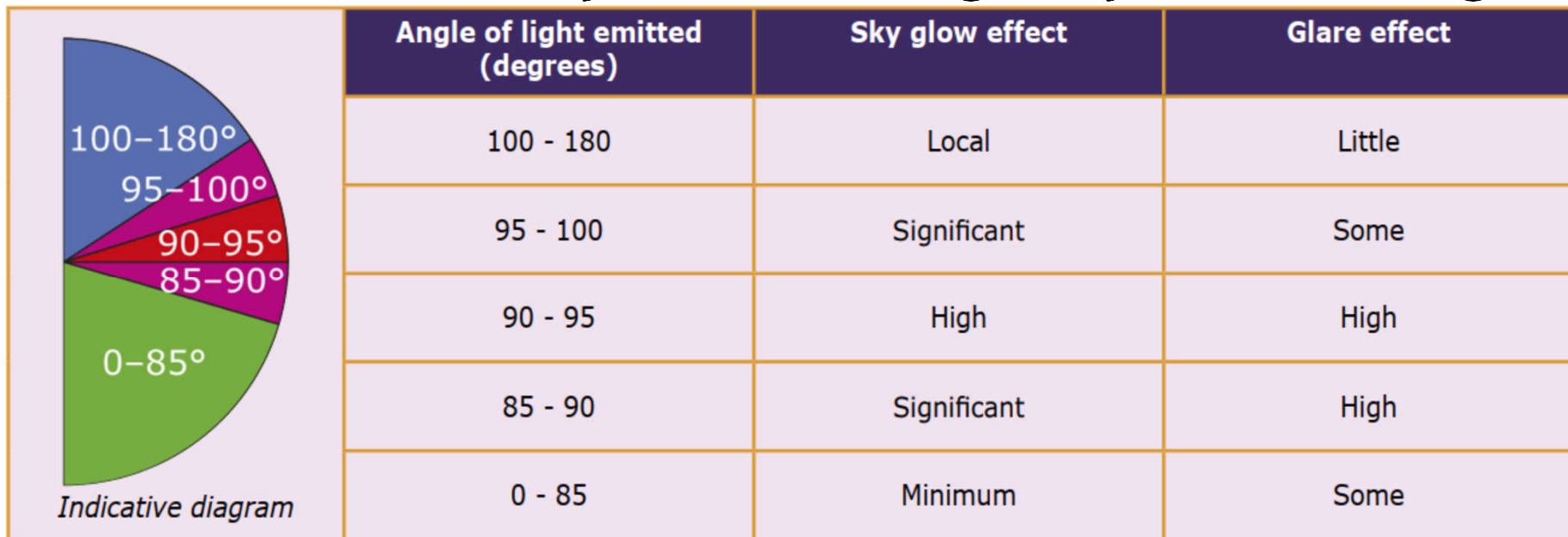

A lower mounting height can create a higher level of light spill & require additional lighting points

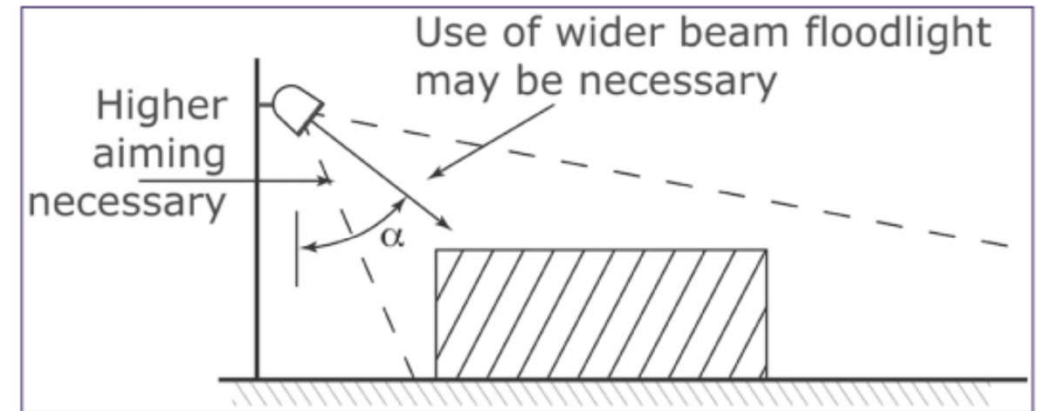
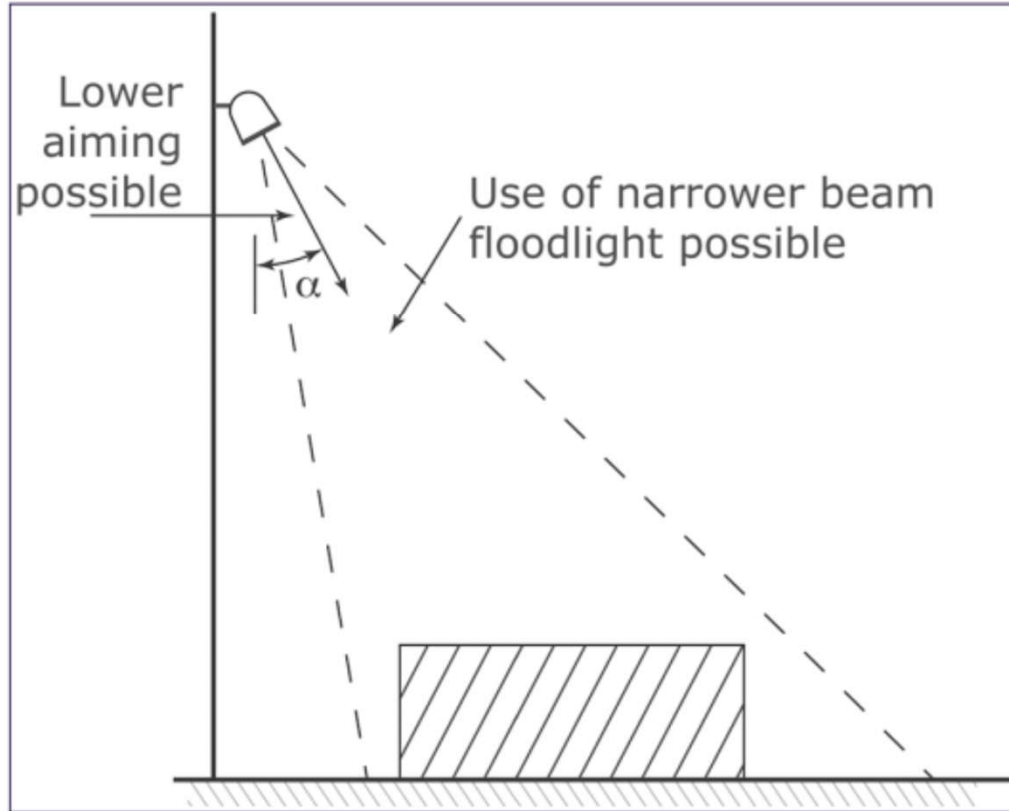

✓ **Figure 2a: Higher mounting height**
– less spill light and glare

✗ **Figure 2b: Lower mounting height**
– more spill light and glare

Suggested luminaire aiming angles & façade illumination

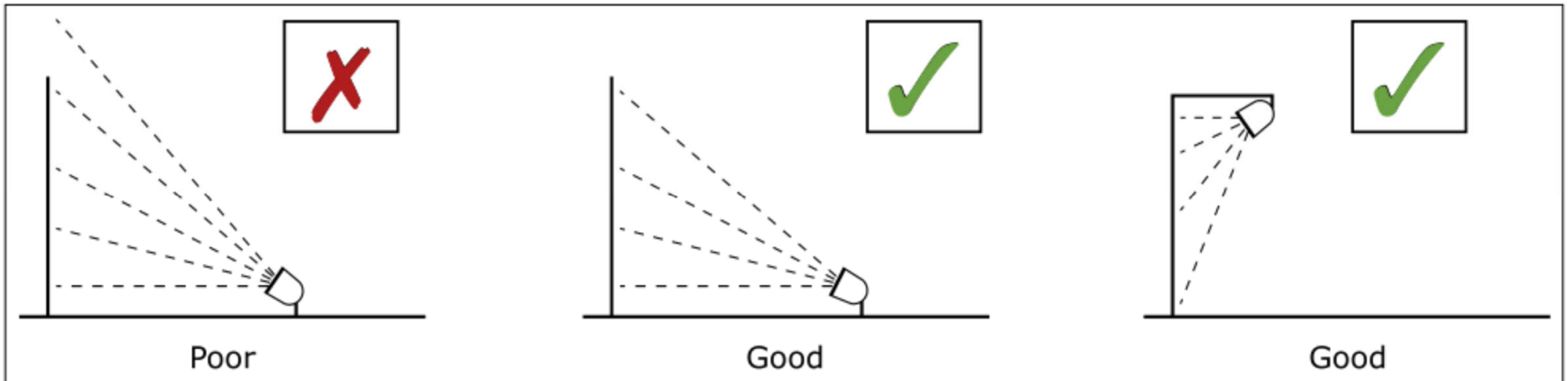
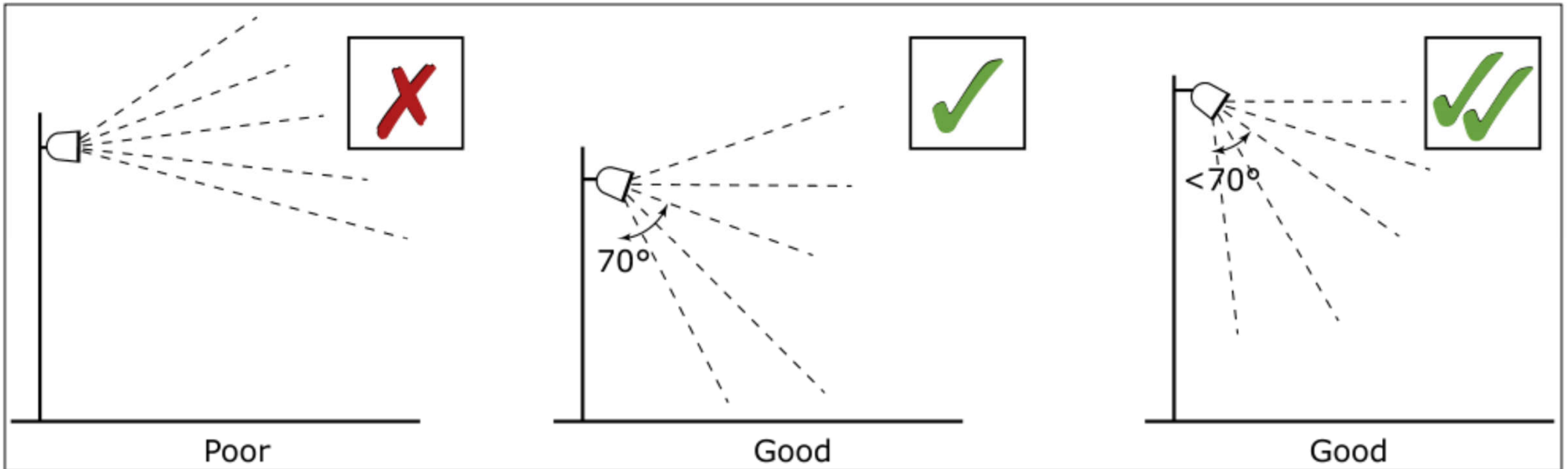

Illustrations of luminaire accessories for limiting obtrusive light



Luminaire with cowl, hood & shield



With louvre



With cowl

Outdoor Lighting



- Need to reduce obtrusive light & control light spill, light intrusion (nuisance) & sky glow
- Five principles of responsible outdoor lighting
 - 1. Useful
 - 2. Targeted
 - 3. Low light levels
 - 4. Controlled
 - 5. Colour
- To save energy & money, reduce light pollution, and minimize wildlife disruption

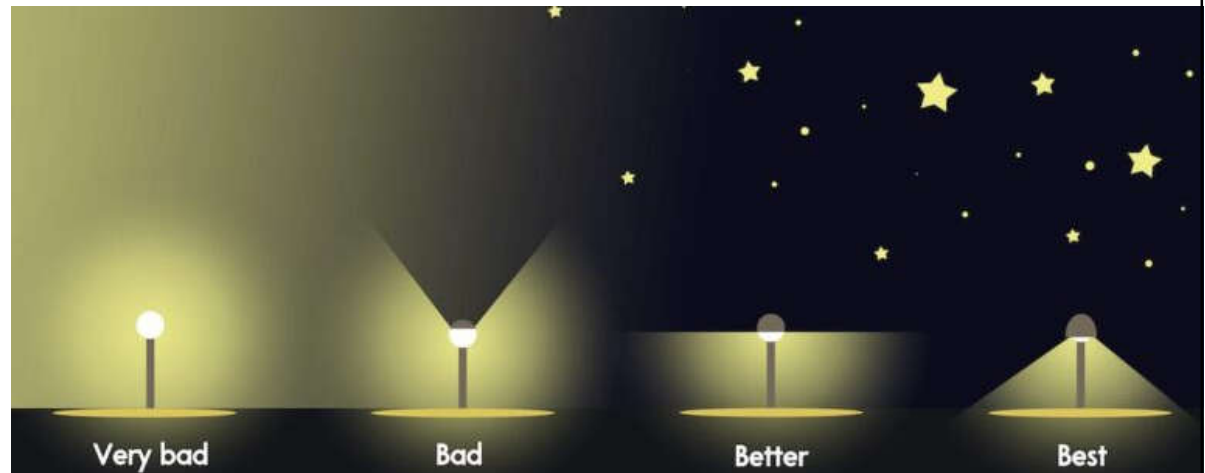

Five principles for responsible outdoor lighting

LIGHT TO PROTECT THE NIGHT

Five Principles for Responsible Outdoor Lighting



Illuminating
ENGINEERING SOCIETY



USEFUL



ALL LIGHT SHOULD HAVE A CLEAR PURPOSE

Before installing or replacing a light, determine if light is needed. Consider how the use of light will impact the area, including wildlife and the environment. Consider using reflective paints or self-luminous markers for signs, curbs, and steps to reduce the need for permanently installed outdoor lighting.

TARGETED



LIGHT SHOULD BE DIRECTED ONLY TO WHERE NEEDED

Use shielding and careful aiming to target the direction of the light beam so that it points downward and does not spill beyond where it is needed.

LOW LIGHT LEVELS



LIGHT SHOULD BE NO BRIGHTER THAN NECESSARY

Use the lowest light level required. Be mindful of surface conditions as some surfaces may reflect more light into the night sky than intended.

CONTROLLED



LIGHT SHOULD BE USED ONLY WHEN IT IS USEFUL

Use controls such as timers or motion detectors to ensure that light is available when it is needed, dimmed when possible, and turned off when not needed.

COLOR



USE WARMER COLOR LIGHTS WHERE POSSIBLE

Limit the amount of shorter wavelength (blue-violet) light to the least amount needed.

Examples of acceptable / unacceptable lighting fixtures

Unacceptable / Discouraged

Fixtures that produce glare and light trespass

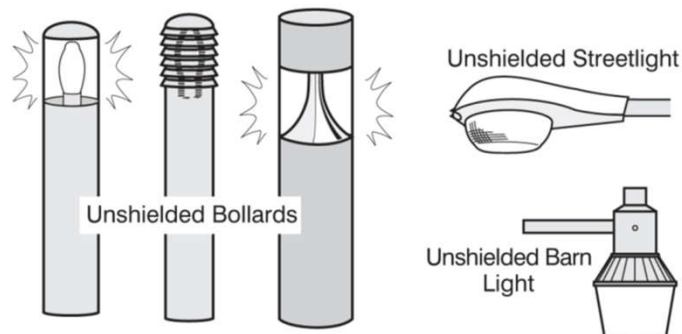
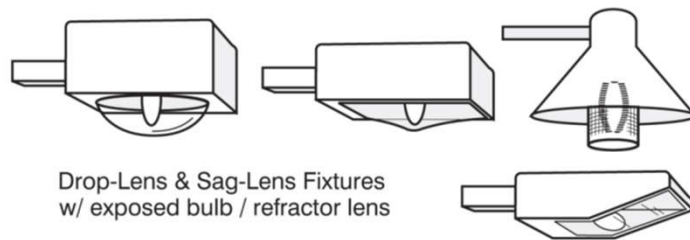
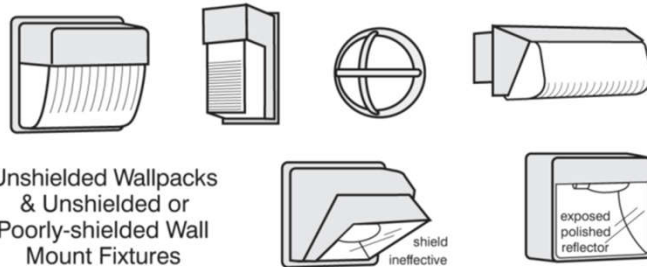
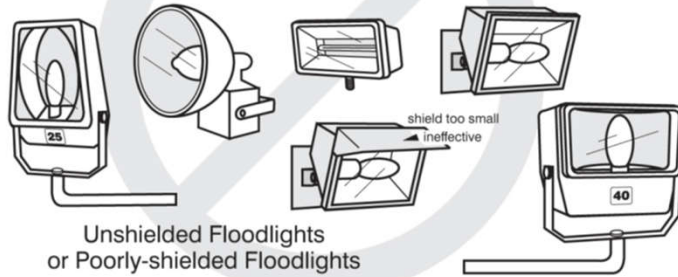

Acceptable

Fixtures that shield the light source to minimize glare and light trespass and to facilitate better vision at night

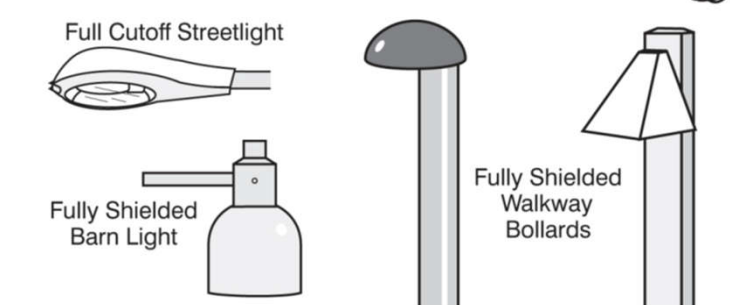
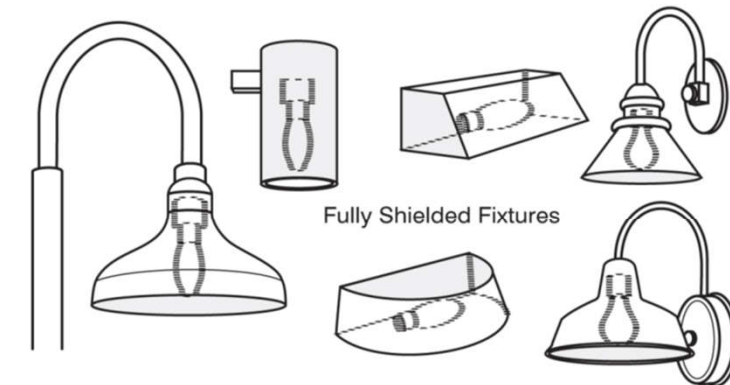
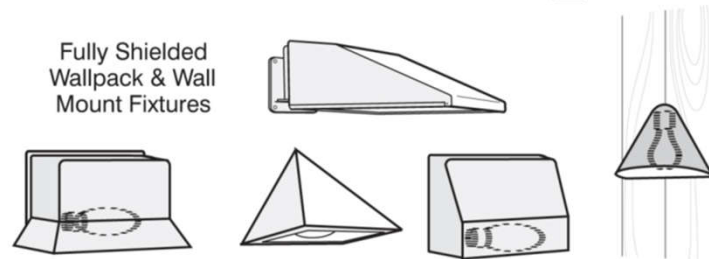
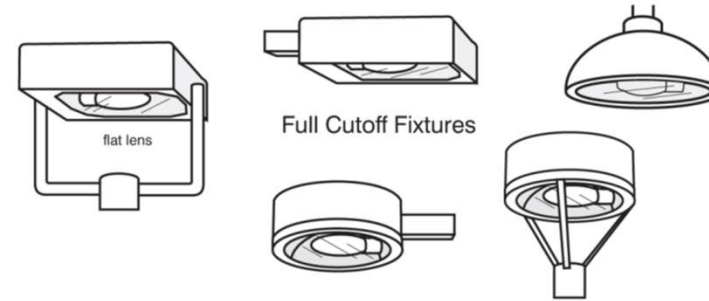

CIE environmental lighting zoning system

Zone	Zone description
E0 (protected)	Dark: IDA Dark Sky Parks, UNESCO Starlight Reserves
E1 (natural)	Intrinsically dark: areas of outstanding natural beauty (where roads are usually unlit), relatively uninhabited rural areas
E2 (rural)	Low district brightness: Outer urban and rural residential areas (where roads are lit to residential road standard), village or relatively dark outer suburban locations
E3 (suburban)	Middle district brightness: Generally urban residential areas (where roads are lit to traffic route standard), small town centres or suburban locations
E4 (urban)	High district brightness: Generally, urban areas having mixed recreational & commercial land use with high night-time activity, town & city centres

Maximum obtrusive light permitted for exterior lighting installations

Environmental zone	Light on properties		Luminaire intensity		Upward light	Luminance	
	E_v		I			L_b	L_s
	lx		cd		%	$\text{cd}\cdot\text{m}^{-2}$	$\text{cd}\cdot\text{m}^{-2}$
	Pre curfew ^(a)	Post curfew	Pre curfew	Post curfew		Building	Signs
<i>E1</i>	2	0 ^(b)	2500	0	0	0	50
<i>E2</i>	5	1	7500	500	0.05	5	400
<i>E3</i>	10	2	10 000	1000	0.15	10	800
<i>E4</i>	25	5	25 000	2500	0.25	25	1000

(a) In case no curfew regulations are available, the higher values shall not be exceeded and the lower values should be taken as preferable limits.

(b) If the luminaire is for public (road) lighting, then this value may be up to 1 lx.

E_v = the maximum value of vertical illuminance on properties in lx

I = the light intensity of each source in the potentially obtrusive direction in cd

ULR = the proportion of the flux of the luminaire(s) that is emitted above the horizontal, when the luminaire(s) is (are) mounted in its (their) installed position and attitude, and given in %

L_b = the maximum average luminance of the facade of a building in $\text{cd}\cdot\text{m}^{-2}$

L_s = the maximum average luminance of signs in $\text{cd}\cdot\text{m}^{-2}$

(Source: SLL Code for Lighting 2012)



Further Reading

- Design examples Outdoor
<https://www.ereco.com/en/designing-with-light/lighting-knowledge/design-examples-outdoor/>
- Light for outdoors: Public & Outdoor – light for outdoor areas in public spaces <https://www.ereco.com/en/projects/public/>
- Correctly illuminating art in outdoor spaces
<https://www.ereco.com/en/projects/public/correctly-illuminating-art-in-outdoor-spaces-7243/>
- Outdoor and Amenity Lighting
http://ibse.hk/IBTM5680/Outdoor_and_Amenity_Lighting.pdf