

Lighting Calculations

Ir Dr. Sam C. M. Hui

E-mail: sam.cmhui@gmail.com

<http://ibse.hk/cmhui/>



Contents

- Design considerations
- Typical calculations
- Lumen method
- Point-by-point method
- Daylight calculations
- Other calculations

Design considerations



- Video: Lighting Calculations (5:51)

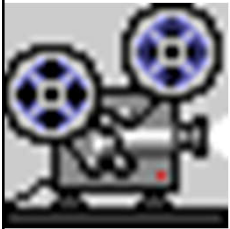

- <https://youtu.be/sfbXx13JgeU>

- Basic lighting calculations that are required to carry out a lighting design

- Luminous flux, luminous intensity, illuminance, luminance, colour rendering, colour temperature
- Glare, working plane, surface reflectances
- Indoor lighting: calculations are done for both the direct & inter-reflected light; room geometry; maintenance
- Outdoor lighting: light falls directly on the working plane

Calculation of surface reflectance distribution (online interactive tool)

Reflectance: 0.885

Specularity: 0.319

Incidence Angle: 47.49°

Specular Angle: -47.49°

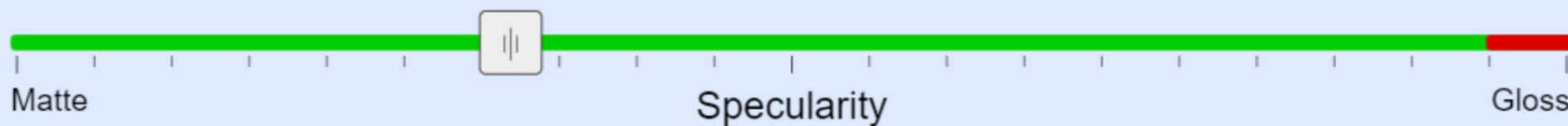
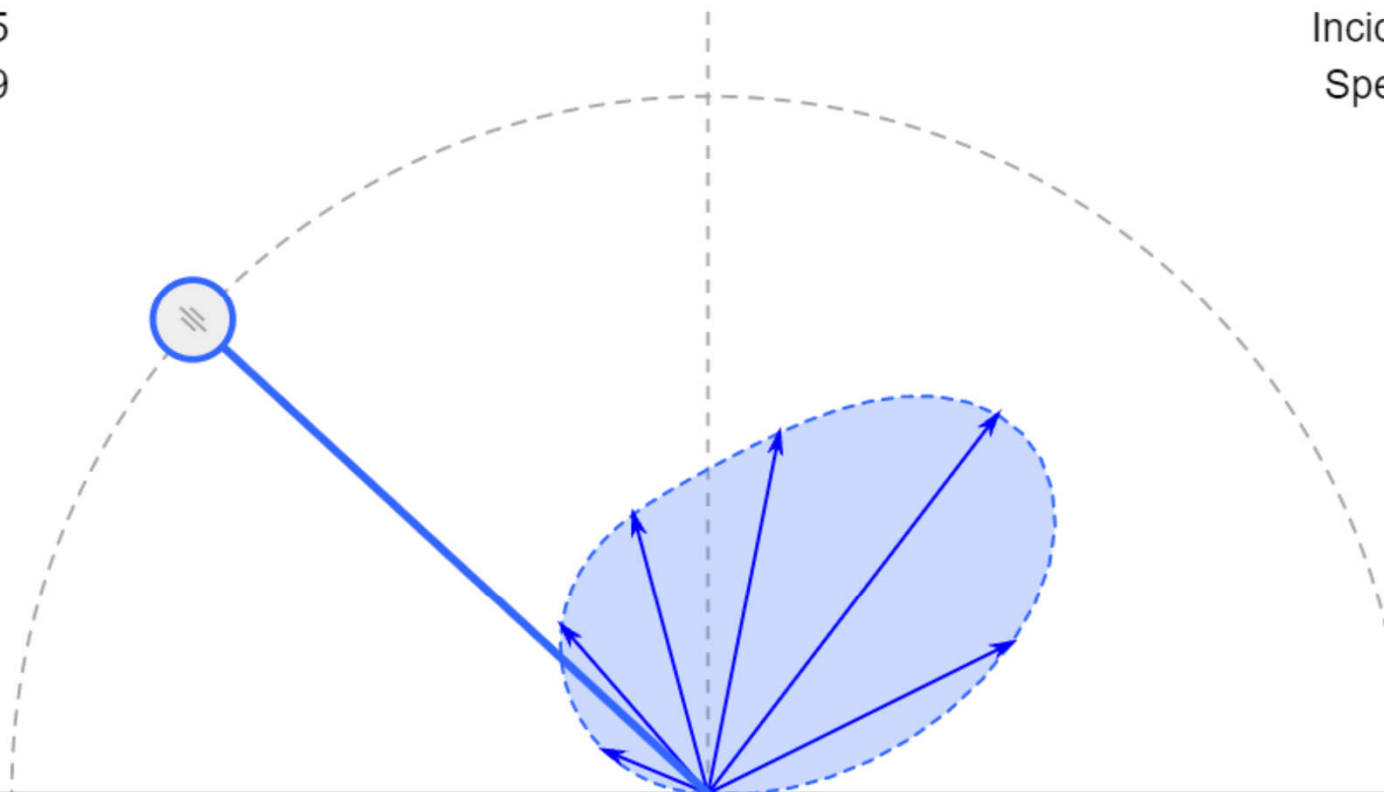

Design considerations



- Lighting design checklist

- Safety (e.g. emergency escape lighting)
- Task requirements
 - Lighting scheme to provide suitable quantity & direction for the task; colour rendering; glare problems

- Lighting appearance

- Architecture/Interior design

- Energy efficiency

- Lighting equipment, controls, daylighting

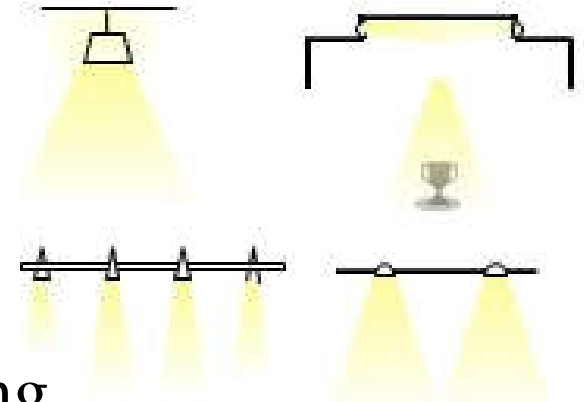

Design considerations



- Lighting equipment checklist

- Lamps

- Operating characteristics, lamp size/shape, colour

- Luminaires

- Size and shape, light distribution, glare control, ballast
- Operating environment (e.g. corrosive, dusty)

- Lighting controls

- Manual switches, time switches, dimming, daylight-linked controls, occupant sensing

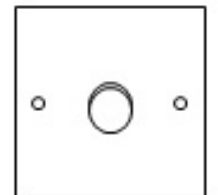
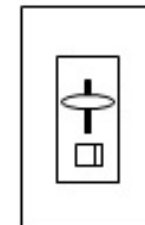
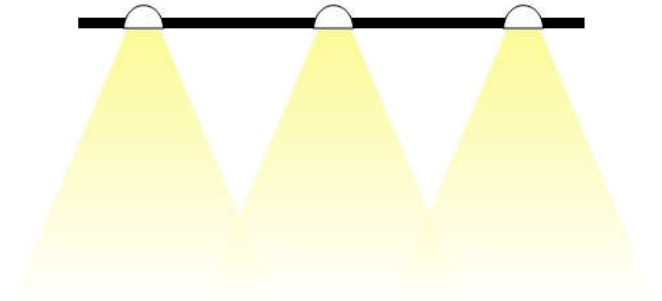

Design considerations



- Collect information for lighting design

- Room details:

- Room size (length, width, height)
- Horizontal working plane height above floor level
- Room surface reflectance (ceiling, walls, floor)
- Window size/s and position
- Room index
 - $K = (L \times W) / (L + W) H$
- Cleanliness of the room/environment
- The regularity of the cleaning

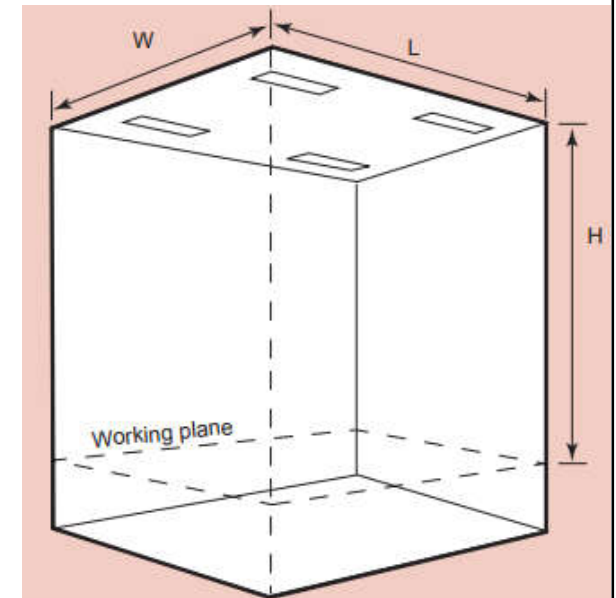

Recommended room reflectances & illuminance ratios

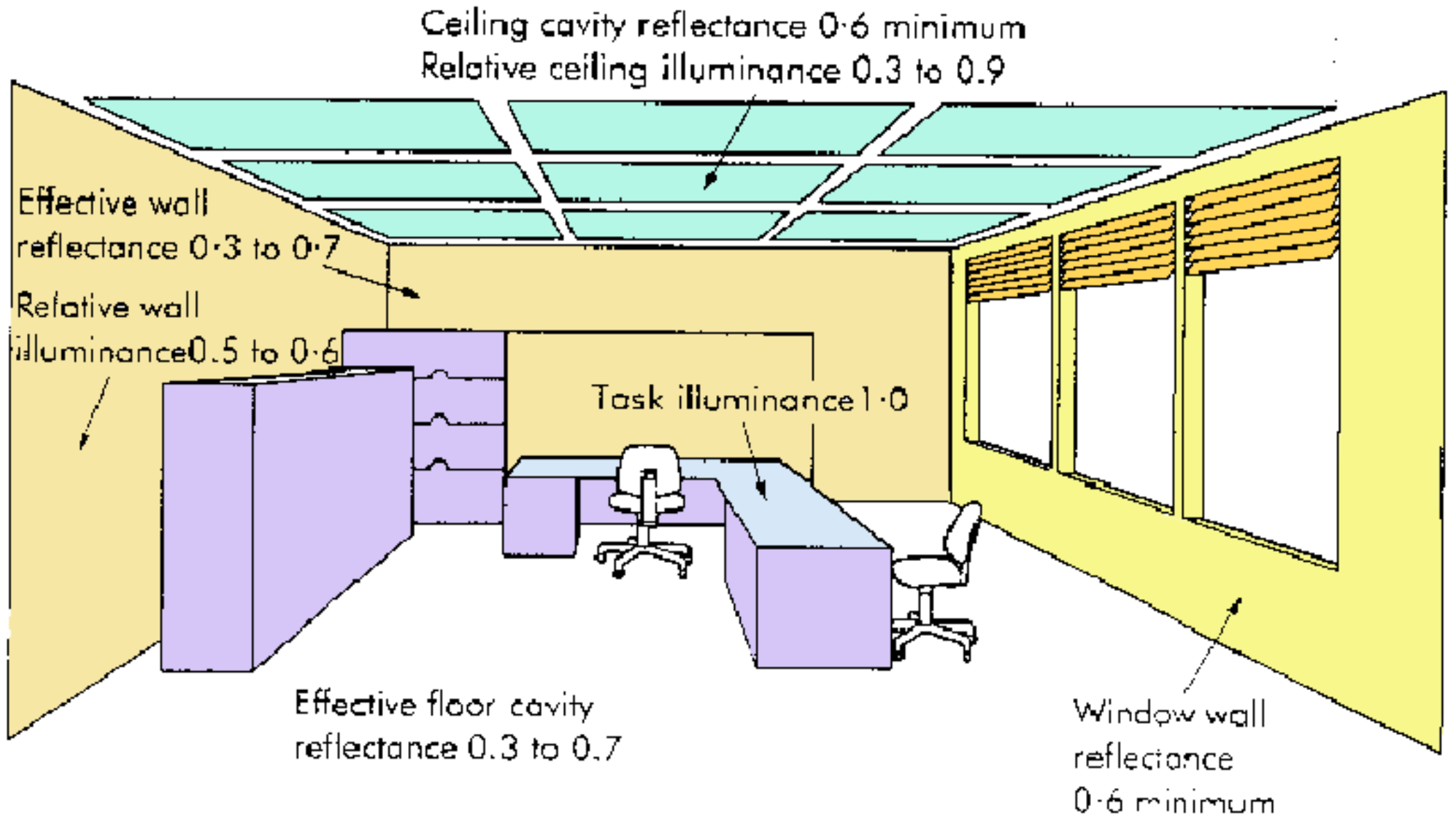

Design considerations



- Collect information for lighting design (cont'd)
 - Task details:
 - Type of task/application (e.g. office, industrial, retail)
 - Task position (e.g. horizontal/vertical, general/local)
 - Special task lighting requirement (e.g. critical inspection, computer use, disabled persons)
 - Special hazards (e.g. wet or dusty environment, rotating machines) -- luminaire thermal & mechanical protection

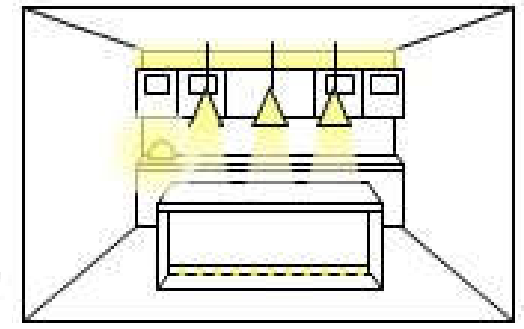
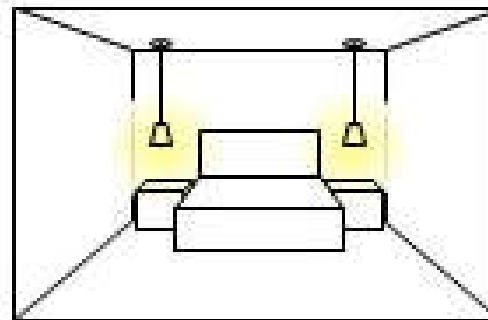

Design considerations



- Collect information for lighting design (cont'd)

- Lighting requirements & design criteria*:

- Task illuminance (lux)
- Task illuminance uniformity (e.g. uniform (0.8), non-uniform (as appropriate)), luminous contrast
- Light colour rendering quality & index (Ra)
- Average installed lighting power density (W/m^2), to meet the building energy code
- Light pollution & reduction of obtrusive light
- Sustainable lighting design

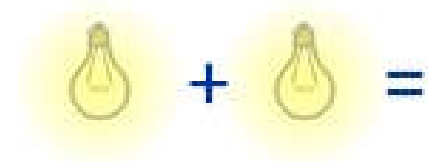

Design considerations



- Collect information for lighting design (cont'd)

- Layers of lighting**:

- Accent lighting (e.g. display lighting, decorative lighting)
- Wall lighting (e.g. display lighting, lighting to create room lightness)
- Ceiling lighting (e.g. lighting to create room lightness)
- Light colour appearance (e.g. warm, intermediate, cool)
- Emergency and/or escape lighting requirement

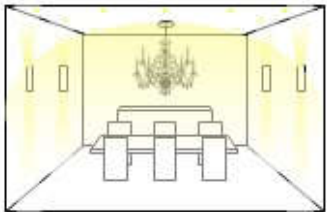

(** Examples of the impact on lighting with differing layers of lighting, and material properties of surfaces inside interior spaces: <http://iarc.uncg.edu/elight/learn/determine/la.html>)



Typical calculations

- To calculate the amount of light that will result from a design
 - Critical for commercial & institutional buildings
 - Seldom required for residential design
- Basic considerations
 - Light sources (lamp lumens)
 - Luminaires & light distribution
 - Initial vs. maintained light levels (as lamps age & luminaires get dirty, light level drops)



Typical calculations

- Technical & economic calculations
 - Connected load ($\text{Watts} = \text{Volts} * \text{Amps}$)
 - Point illuminances (at a defined point in space)
 - Utilisation factor
 - Unified glare rating (UGR)
 - Maintenance factor
 - Lighting costs

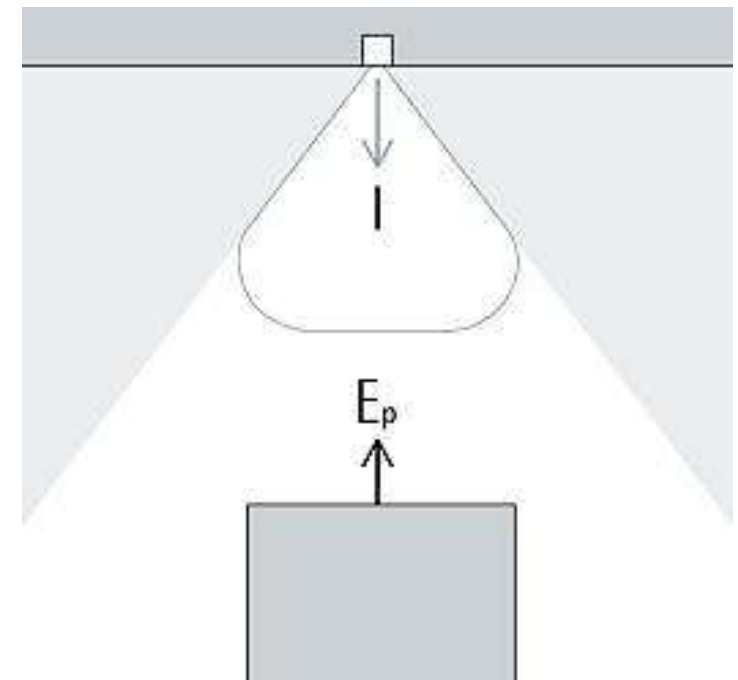

Typical calculations



- Glare calculations:

- Calculations Glare Rating Concepts

- https://docs.agi32.com/AGi32/Content/adding_calculations_on_points/Calculations_Glare_Rating_Concepts.htm

- Calculations UGR Concepts

- https://docs.agi32.com/AGi32/Content/adding_calculations_on_points/Calculations_UGR_Concepts.htm

- Glare (assessment & calculations)

- <https://www.new-learn.info/packages/clear/visual/people/performance/glare/>

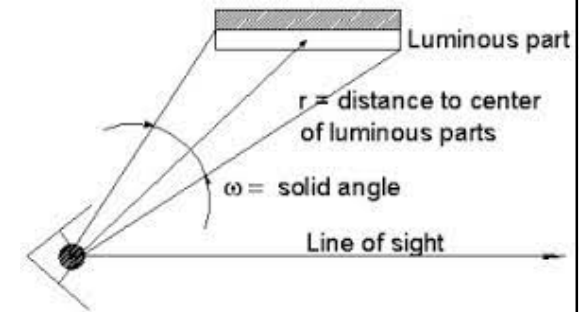



Typical calculations

- Design calculations for simple situations
 - The number & layout of luminaires needed for general lighting
 - What additional luminaires are needed to provide local emphasis or accents
 - Energy efficiency & financial benefits
- Calculation methods:
 - Manual, data sheets/tables, graphical, spreadsheet*, computer software

Grid points for an area & grid for illuminance/uniformity calculations

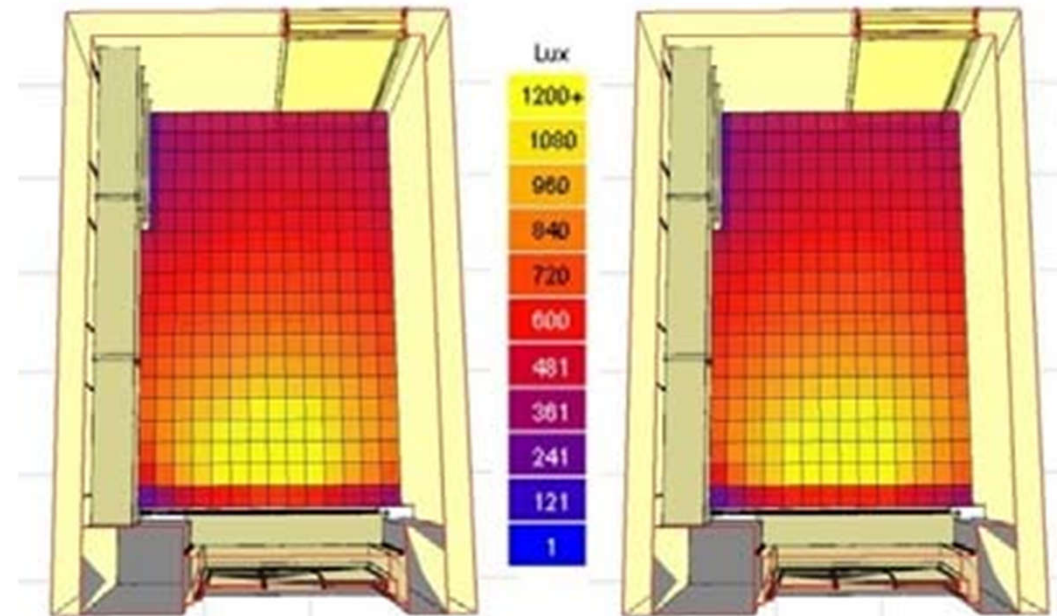
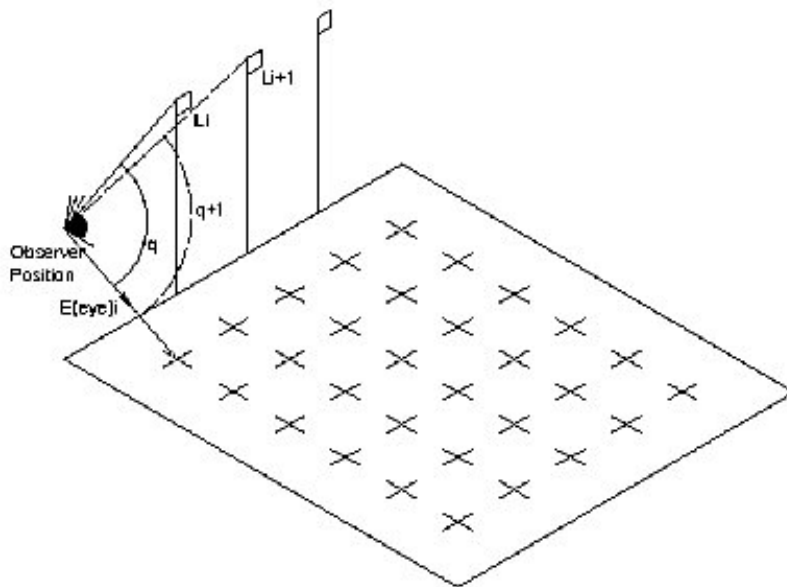
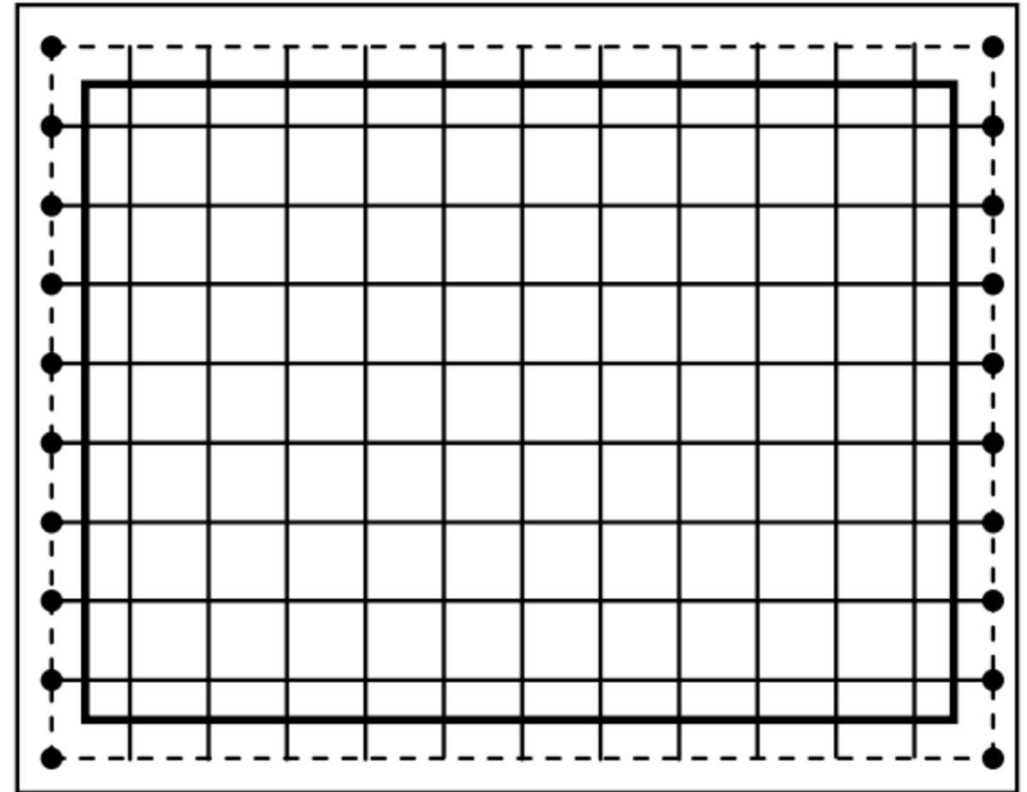
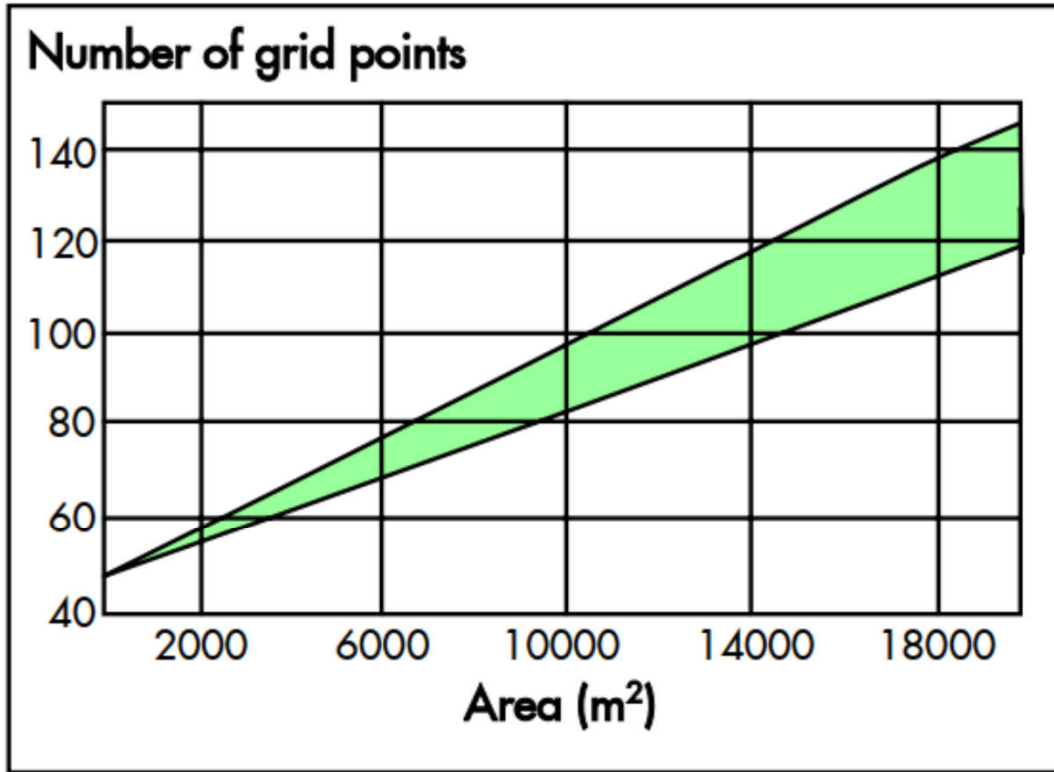



Typical calculations

- Predict general & ambient light levels
 - Rough estimation based on a [Watts/sq.m method](#)
 - Not very accurate, but good for prelim. planning
 - [Lumen method](#) (light flux method)
 - Determines average illuminance in large open areas
 - Good for general lighting
 - [Point-by-point](#) (inverse square law)
 - Determines light levels at a specific point on an object or surface; complicated, start from fundamental laws
 - Can be used for outdoor lighting

Rough estimation based on a Watts/sq.m method

Average light level desired & typical application	Watts/sq.m of fluorescent, CFL or HID lights	Watts/sq.m of incandescent or halogen lamps
25-50 lux Hotel corridors, stair towers	1-2	3-7
50-100 lux Office corridors, parking garages, theatres (house lights)	2-4	7-10
100-200 lux Building lobbies, waiting areas, malls, hotel function spaces	4-8	10-20
200-500 lux Office areas, classrooms, lecture halls, conference rooms, ambient retail lighting, workshops	15-25	Not recommended
500-1000 lux Grocery stores, laboratories, work areas, big box retail stores	12-20	Not recommended



Typical calculations

- An example of calculating the number of indoor lighting fixtures
 - <https://electrical-engineering-portal.com/an-example-of-calculating-the-number-of-indoor-lighting-fixtures>
 - Total wattage
 - Lumen per fixture
 - Minimum spacing
 - Axial spacing
 - Transverse spacing
 - Total fixture number

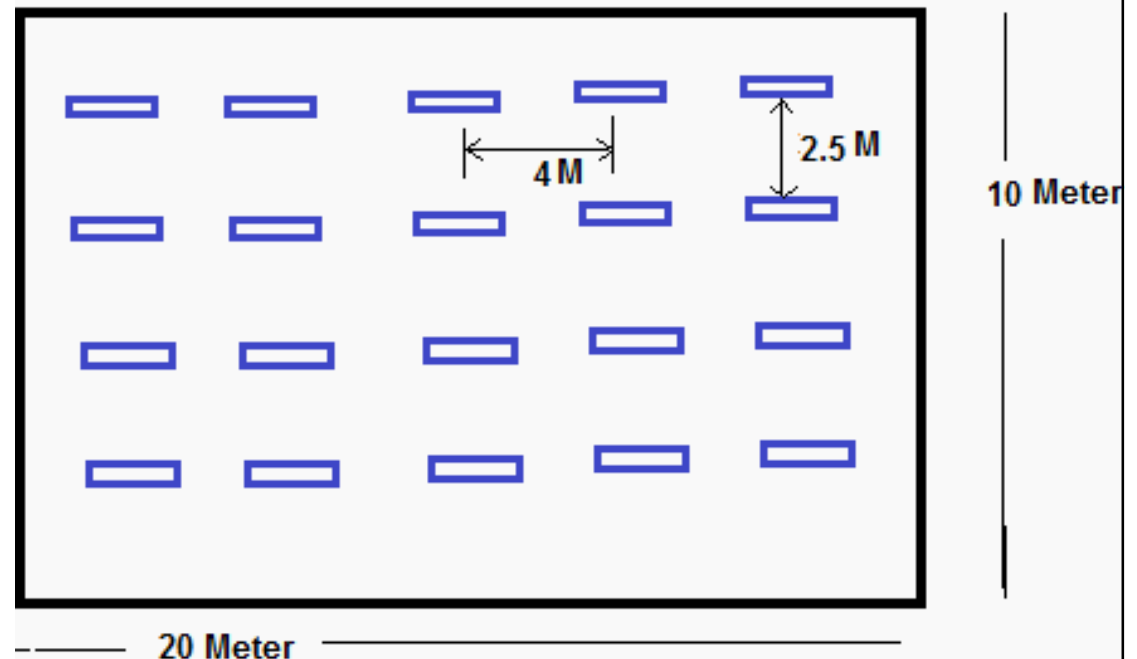



Typical calculations

- Predict task lighting & focal lighting levels
 - Localized fixed or freely adjustable task light
 - Illuminate the actual working area
 - Difficult to predict accurately
 - Methods commonly used
 - Use data/guide of the luminaire's manufacturer
 - Use the inverse-square law to estimate
 - Use a display lighting software program

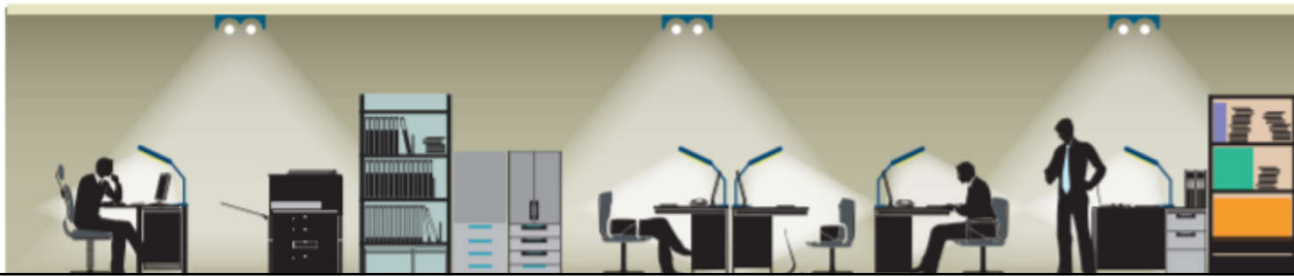

Typical calculations



- Task lighting design
 - Supplement additional light on specific areas where tasks are being performed leaving the other areas at lower ambient illumination level (e.g. for offices, can reduce level of general lighting from 500 lux to 300 lux)
 - Energy & cost saving potential
 - Case study calculations: Task Lighting Design
https://www.emsd.gov.hk/filemanager/en/content_764/Task_Lighting_Design.pdf



Typical calculations

- Determine illuminance level
 - Horizontal (most common)
 - Average illumination on the work plane (lux)
 - Sitting 0.75 to 0.9 m; Standing 0.85 to 1.2m
 - Vertical (e.g. on wall surface)
 - Inclined plane/surface
 - Cylindrical, hemispherical
- Analyse light distribution
 - Using light distribution curves, illumination & isolux diagrams

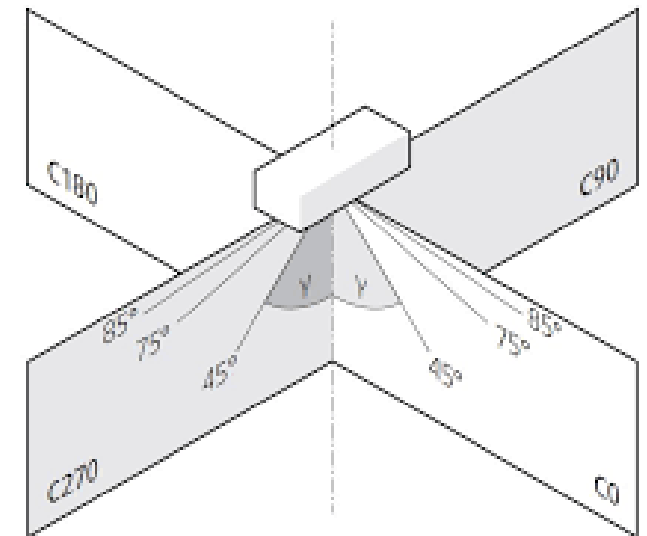

Light distribution curves, illumination & isolux diagrams

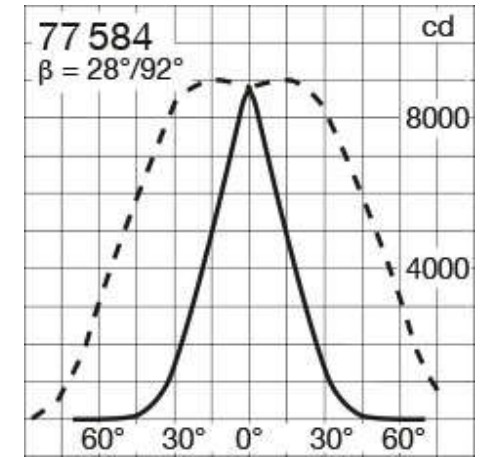
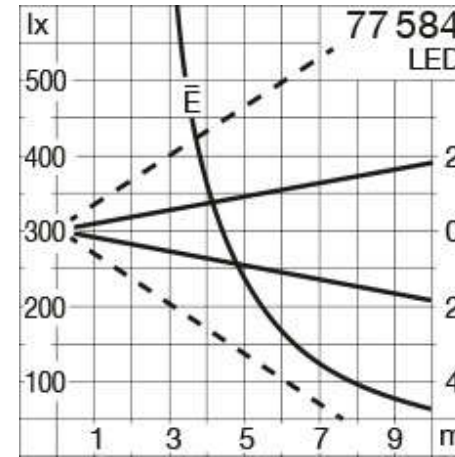
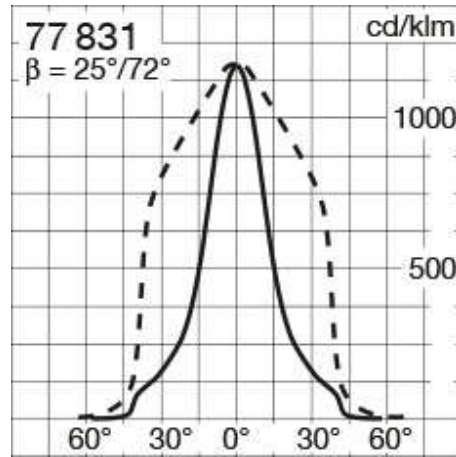
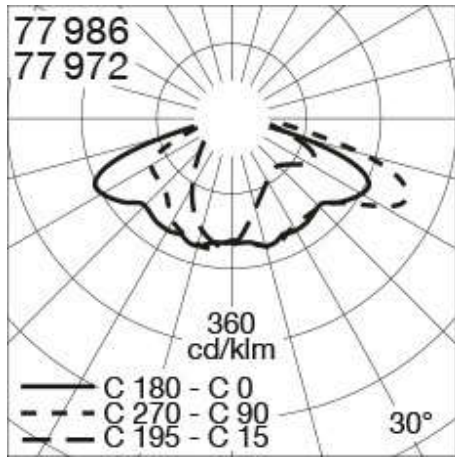

Light distribution curves

Illumination diagrams

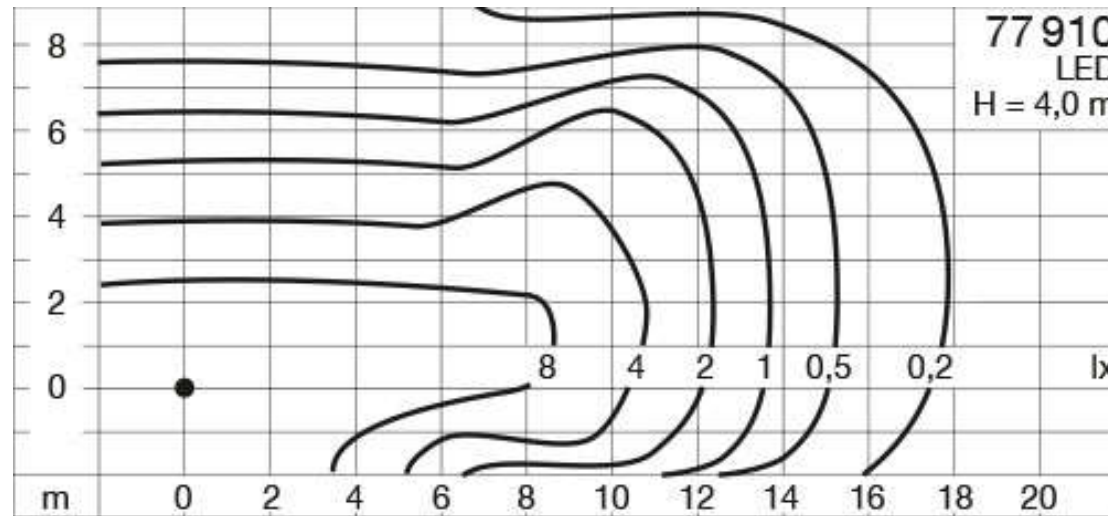

Isolux diagrams

Example: Determination of the luminaire spacing a for pathway illumination of $E_{\min} = 1 \text{ lx}$ on the basis of the isolux diagram

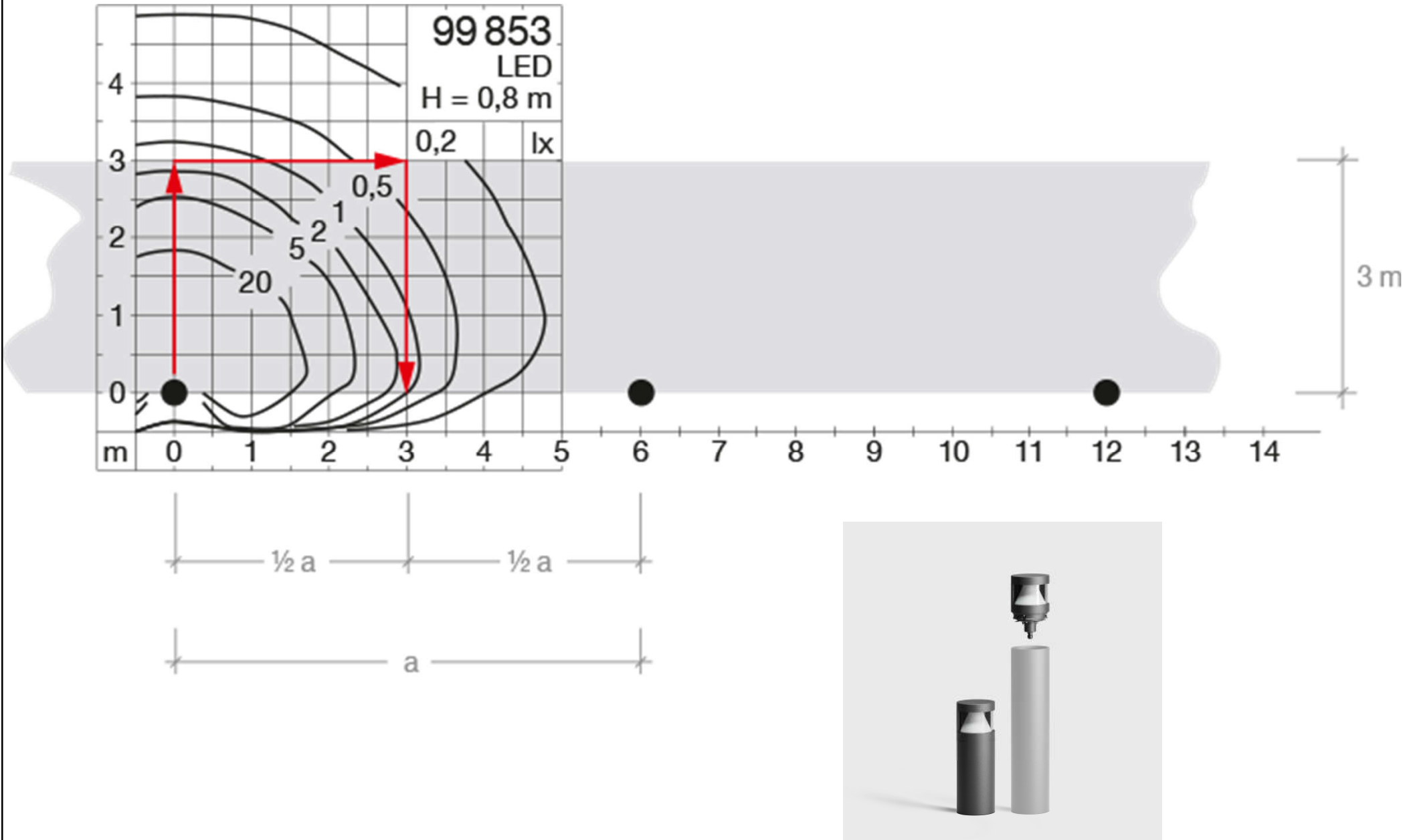

(Source: <http://www.bega.de/en/knowledge/about-light-and-illumination/2-information-about-light-and-illumination/2-06-light-distribution-curves-illumination-and-isolux-diagrams/>)

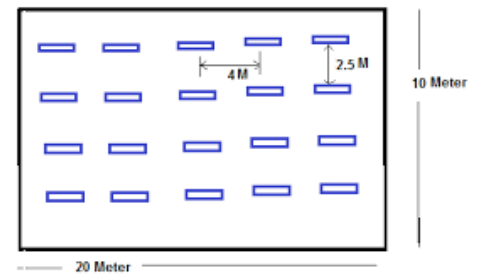

Lumen method

- Lumen method: average illuminance (E) is

$$E = \frac{F \times n \times N \times UF \times MF}{A}$$

- F = initial bare lamp luminous flux (lumens)
- n = number of lamps per luminaire
- N = number of luminaires
- UF = utilisation factor
- MF = maintenance factor
- A = area of the surface (m^2)

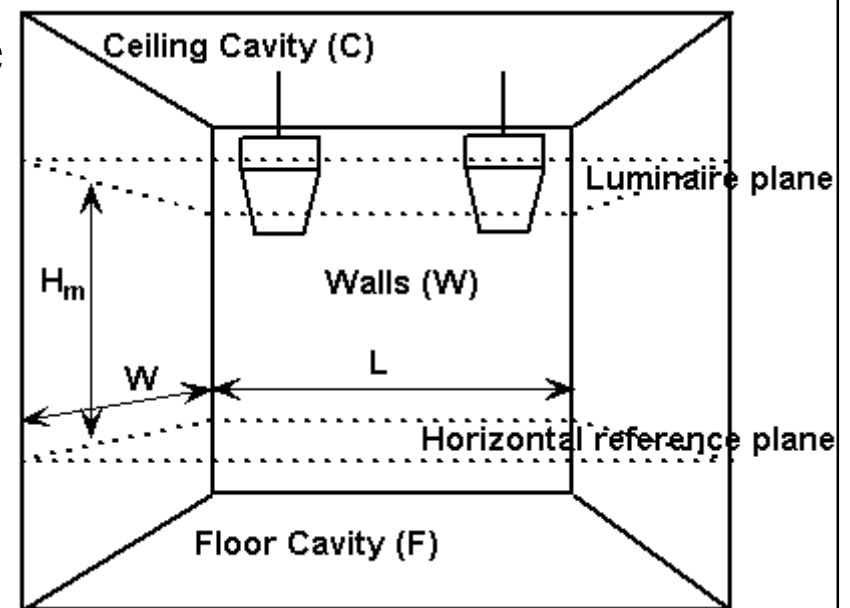

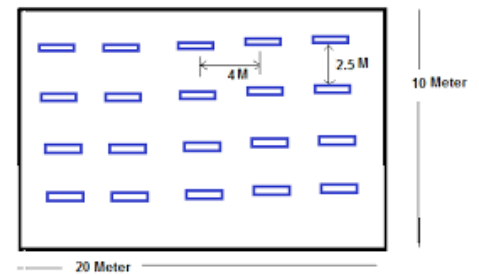

Lumen method

- **Room index (K):** a measure of the proportions of the room, for rectangular room
 - $K = (L \times W) / (L + W) h_m$
 - L = length of the room
 - W = width of the room
 - h_m = height of luminaire above horiz. reference plane
- **Effective reflectances of ceiling, walls & floor**
 - Cavity index (CI) = $(L \times W) / (L + W) h = K \times h_m / h$
 - h = depth of the cavity (ceiling or floor)
 - Determine effective reflectance from tables or formulae (see examples in *CIBSE/SLL Lighting Code*)

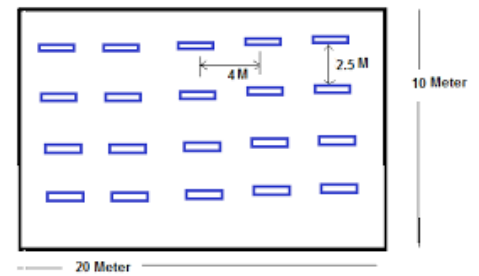

Lumen method

- Utilisation factor (UF)
 - Ratio of total flux received by the surface to the total lamp flux of the installation
 - Indicates the effectiveness of the lighting scheme
 - UF depends on the efficiency of luminaire, luminaire distribution, geometry of the space, room reflectance, polar curve
 - Usually, UF tables are prepared for general lighting with regular arrays of luminaires, for 3 main room surfaces: ceiling cavity, walls, and floor cavity or horizontal reference plane

Example of luminaire photometric data and utilisation factor

Luminaire type: single 1.5 m, 58 W fluorescent lamp fitting, incorporating a white louvre attachment.

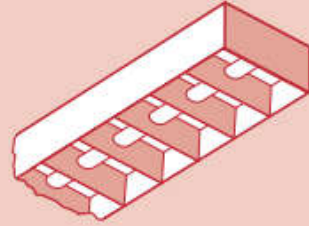
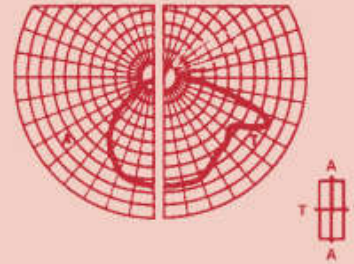

Illustration of luminaire



*Luminous Intensity Distributions
(polar curves) – axial (A) and transverse (T)*

Light output ratio: upward – 0.0; downward – 0.55; total – 0.55.

Spacing/height ratio: nominal – 1.5; maximum (square) – 1.7, maximum (continuous) – 2.0.

Room index	0.75	1.0	1.25	1.5	2.0	2.5	3.0	4.0	5.0
Room reflectances C W F									
70 - 50 - 20	0.36	0.42	0.47	0.51	0.56	0.60	0.63	0.66	0.69
30	0.31	0.36	0.42	0.46	0.52	0.56	0.59	0.63	0.66
10	0.27	0.32	0.37	0.41	0.47	0.52	0.55	0.60	0.63
50 - 50 - 20	0.33	0.38	0.43	0.46	0.51	0.54	0.57	0.60	0.62
30	0.29	0.34	0.38	0.42	0.51	0.51	0.53	0.57	0.59
10	0.25	0.30	0.35	0.38	0.44	0.48	0.50	0.54	0.57
30 - 50 - 20	0.31	0.35	0.39	0.42	0.46	0.49	0.51	0.54	0.55
30	0.27	0.31	0.35	0.38	0.43	0.46	0.48	0.52	0.54
10	0.23	0.28	0.32	0.35	0.40	0.44	0.46	0.50	0.52
0 - 0 - 0	0.20	0.24	0.28	0.30	0.34	0.37	0.39	0.42	0.44

Using the table

Calculate the room index – see section 4, page 15

Decide on the appropriate reflection factors for ceiling (C), walls (W) and floor (F) – see section 4, page 15

Locate utilisation factor at intersection of appropriate column and row

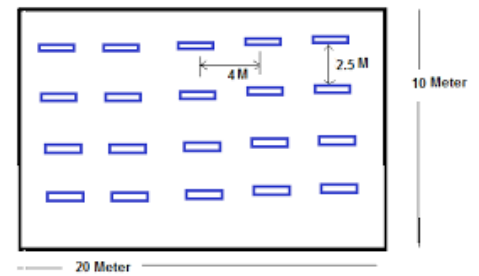

Lumen method

- Maintenance factor (MF)
 - Ratio of maintained illuminance to initial illuminance (losses for lamp lumen maintenance)
 - $MF = LLMF \times LSF \times LMF \times RSMF$
 - Lamp lumen maintenance factor (LLMF)
 - Lamp survival factor (LSF)
 - Luminaire maintenance factor (LMF)
 - Room surface maintenance factor (RSMF)
 - See *CIBSE/SLL Code of Lighting* for description

Maintenance factor & light depreciation

Environmental condition	Maintenance factor
Clean	0.9
Average	0.8
Dirty	0.7

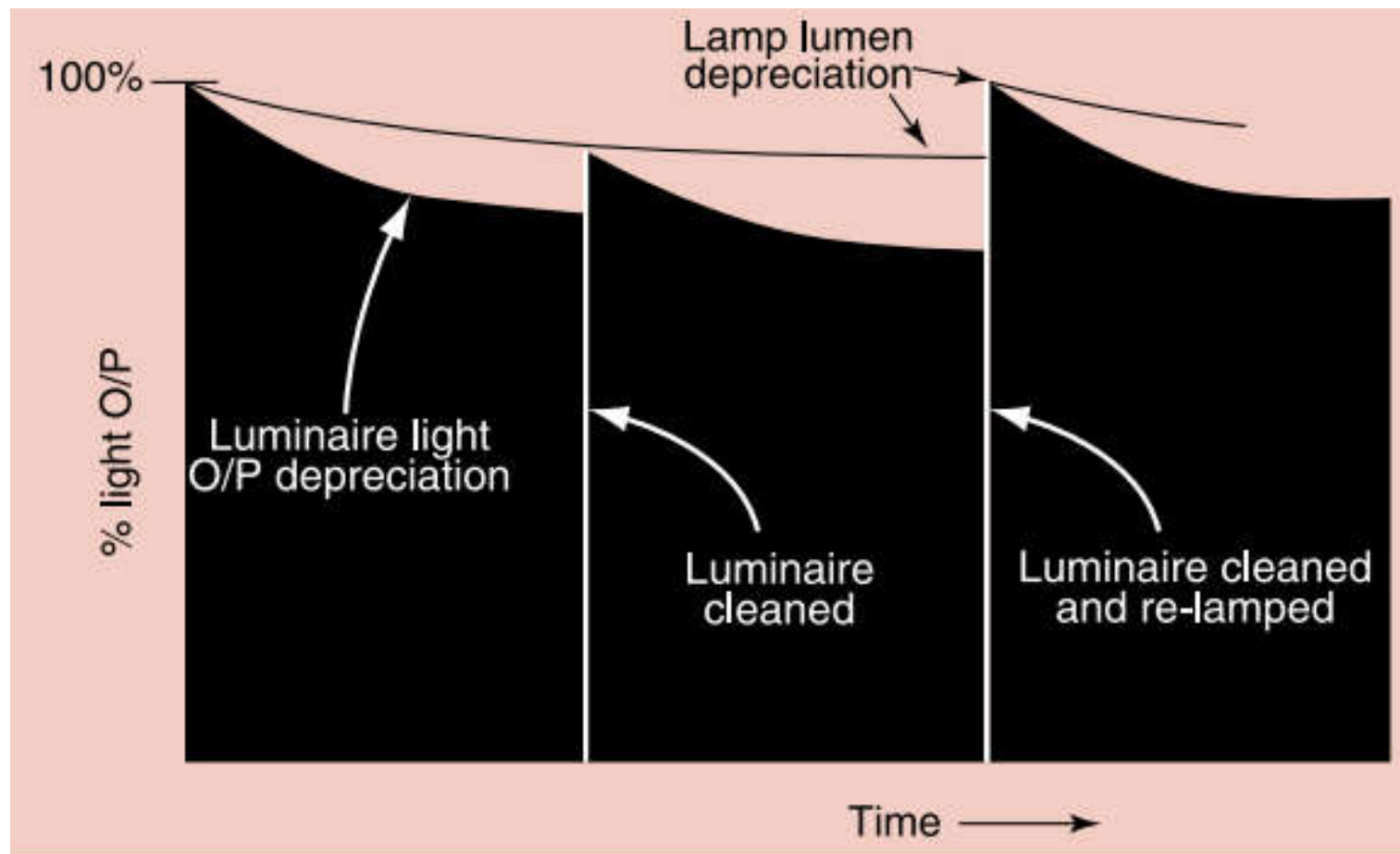

Maintenance factor & lumen maintenance effects

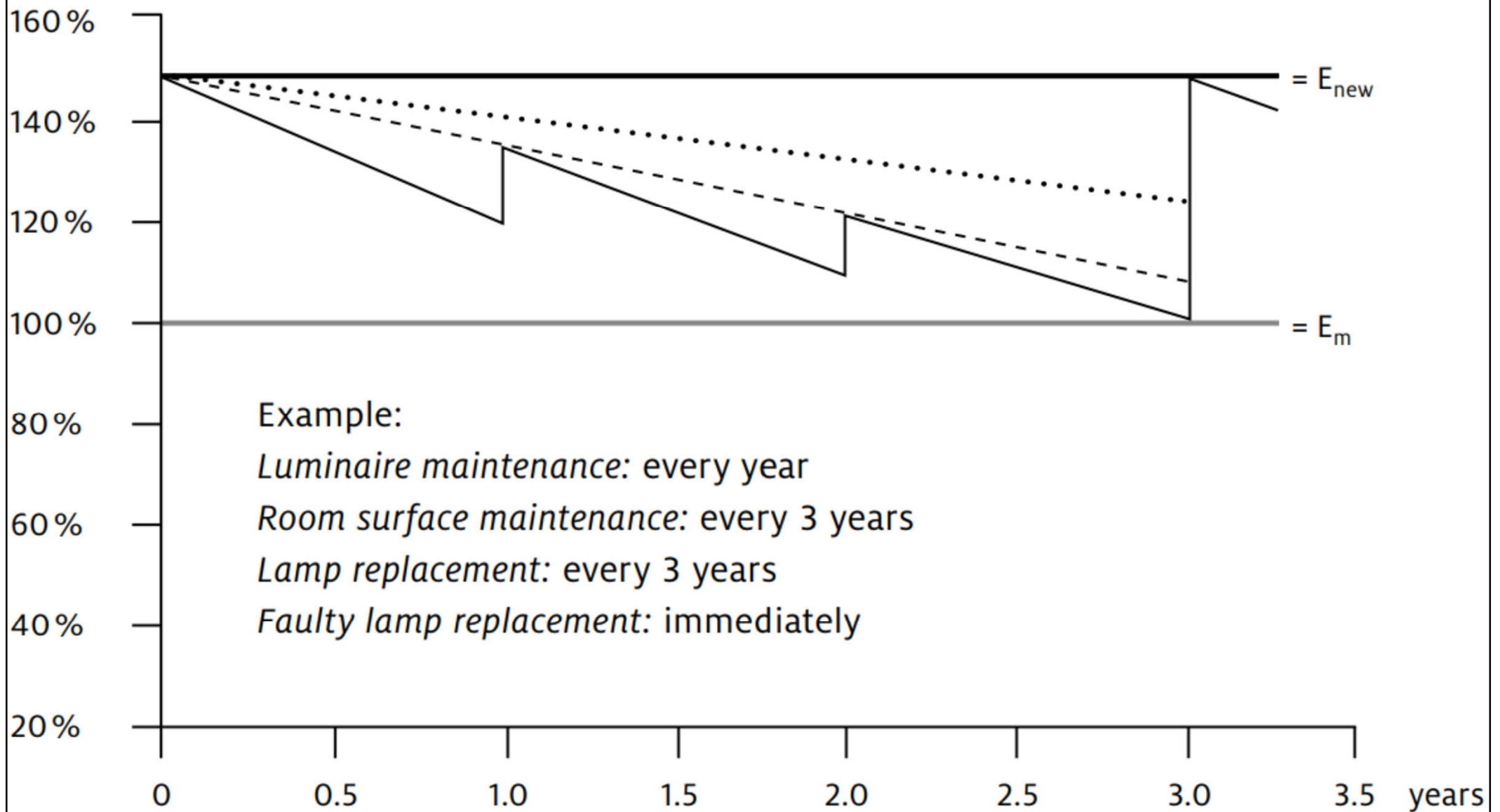

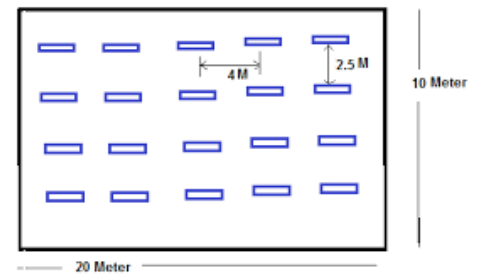

Lumen method

- The number of luminaires required for a required illuminance level E (lux) is:

$$N = \frac{E \times A}{F \times n \times UF \times MF}$$

- Planning the luminaire layout
 - Work out a regular layout of luminaires with an acceptable uniformity
 - Rounding the number found to a whole number that will divide into a regular grid
 - Check on the spacing to height ratio

Luminaire layout and spacing

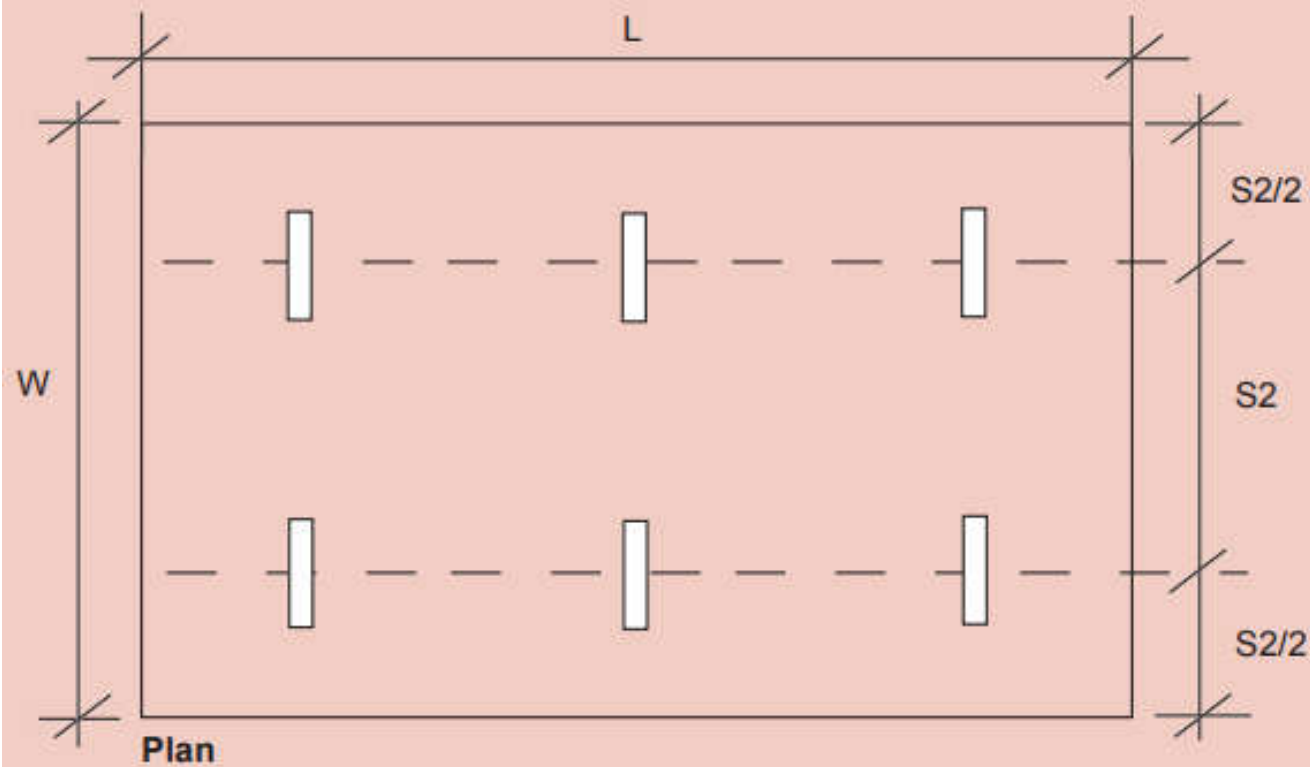
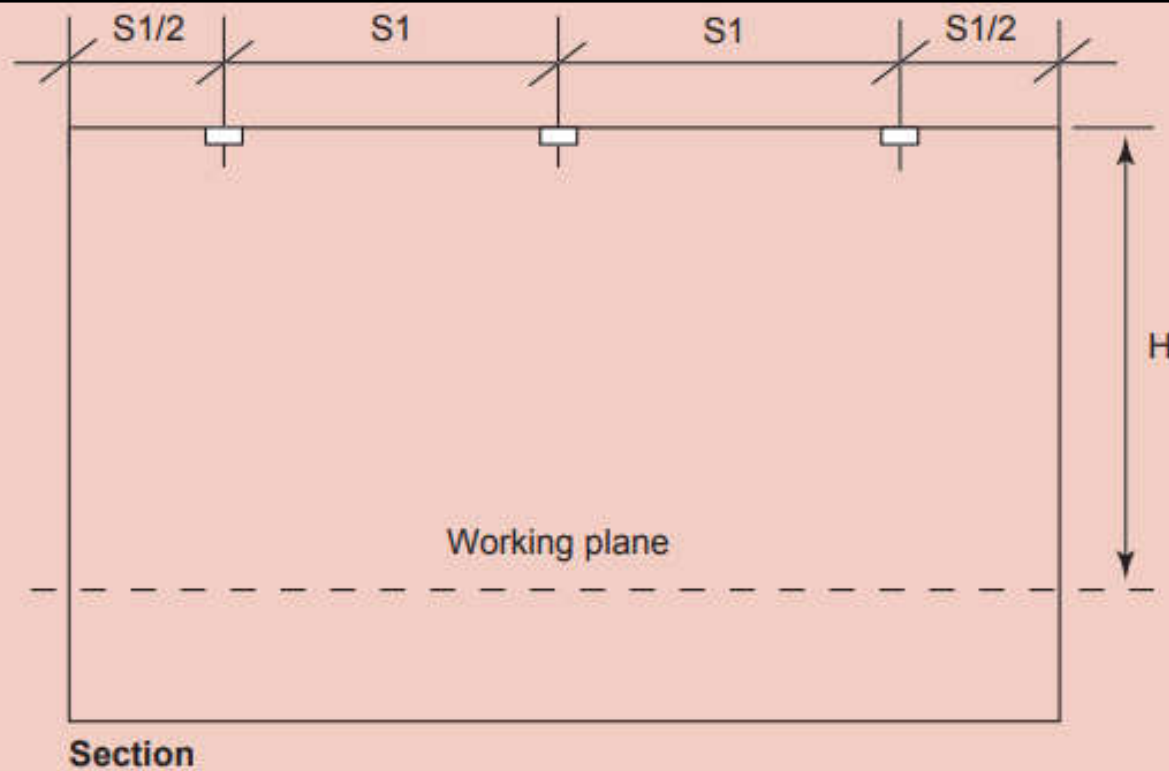

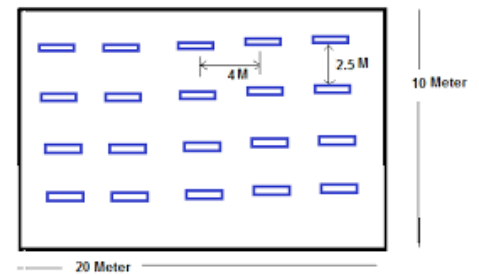

Lumen method

- Spacing to height ratio (SHR)
 - Ratio of distance between adjacent luminaires (centre to centre) to their height above the working plane

$$SHR = \frac{1}{H_m} \sqrt{\frac{A}{N}}$$
 - where H_m = mounting height; A = total floor area; N = number of luminaires
- Maximum spacing to height ratio (SHR_{max})
 - Luminaire spacing shall not exceed the maximum (provided by manufacturer) to ensure uniformity

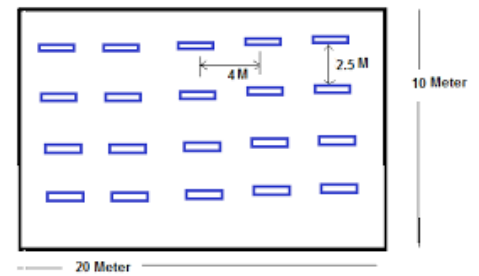

Lumen method

- Lumen method: calculation procedure - a summary
 - Calculate room index K , floor/ceiling cavity index
 - Calculate effective reflectances of ceiling cavity, walls & floor cavity
 - Determine utilisation factor (UF) from manufacturer's data, using the room index and effective reflectances
 - Determine maintenance factor (MF)
 - Obtain nos. of luminaires required
 - Determine a suitable layout
 - Check that the geometric mean spacing-to-height ratio
 - Check the layout does not exceed SHR_{max}
 - Calculate illuminance achieved by the final layout

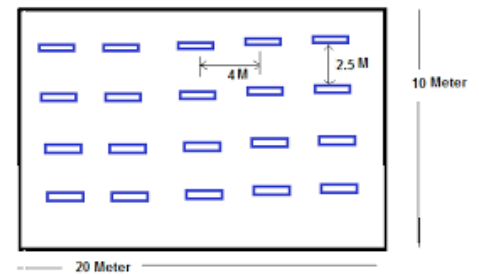

Lumen method

- Basic assumptions underlying the lumen method
 - Rectangular room
 - Ratio of length to width = 1.6 : 1, with a max. of 4 : 1
 - Completely empty room
 - Uniform reflectance & completely diffuse reflection properties of the perimeter surfaces
 - Uniform distribution of luminous flux over all areas
 - Regular luminaire configuration throughout the room
 - In the case of fluorescent lamps, luminaire axis = room axis

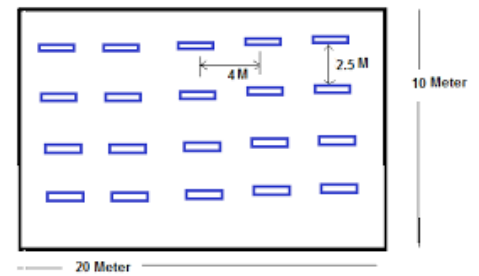

Lumen method

- Examples of lumen method calculations:
 - Lighting Design Calculation in a Building – Step by Step
 - <http://www.electricaltechnology.org/2017/03/lighting-design-calculation-in-building.html>
 - Videos:
 - What is Lumen method? (4:46) <https://youtu.be/WUxwNUdGycI>
 - Lighting Calculations: Lumen Method (3:36) https://youtu.be/CFxM_xXnY7A
 - Lumen Method Lighting Calculation Example (14:55) <https://youtu.be/Rn8wJRY-9WU>

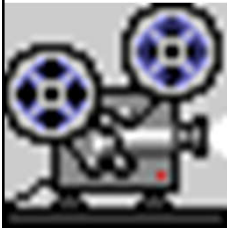



Point-by-point method

- Predict direct illuminance at each point on a plane, using measured data of luminous intensity distribution of a source or a luminaire
 - Based on the inverse square law & cosine law
- Three factors must be considered:
 - Luminous intensity
 - Distance
 - Orientation of the surface

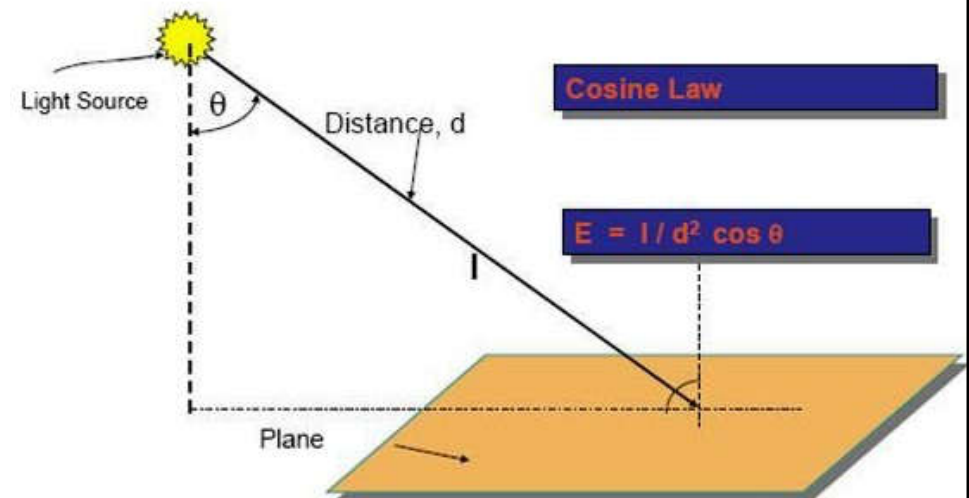

Inverse Square Law for lighting calculations

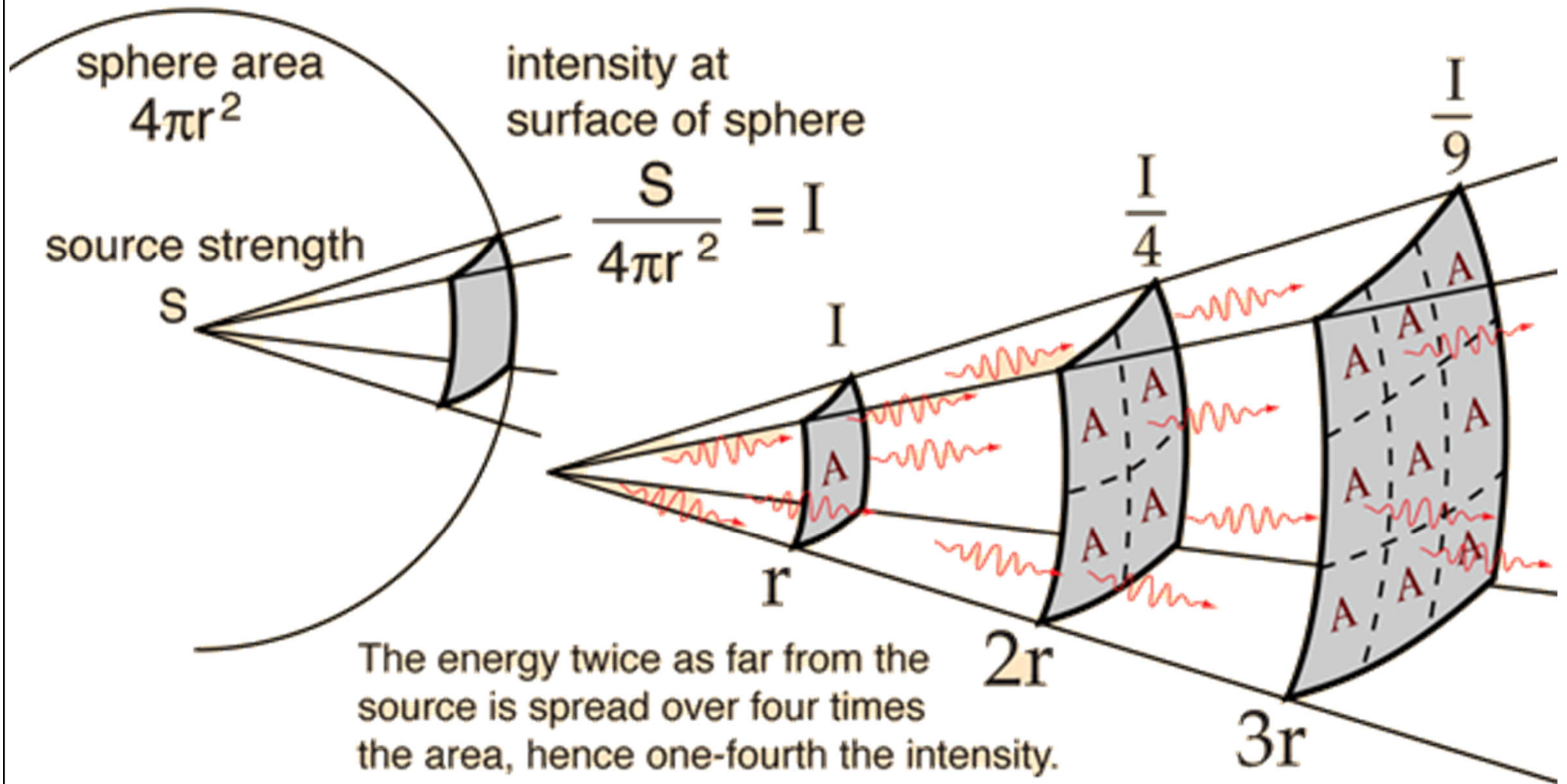

Cosine Law for lighting calculations

COSINE LAW (Illuminance on Tilted Surface)

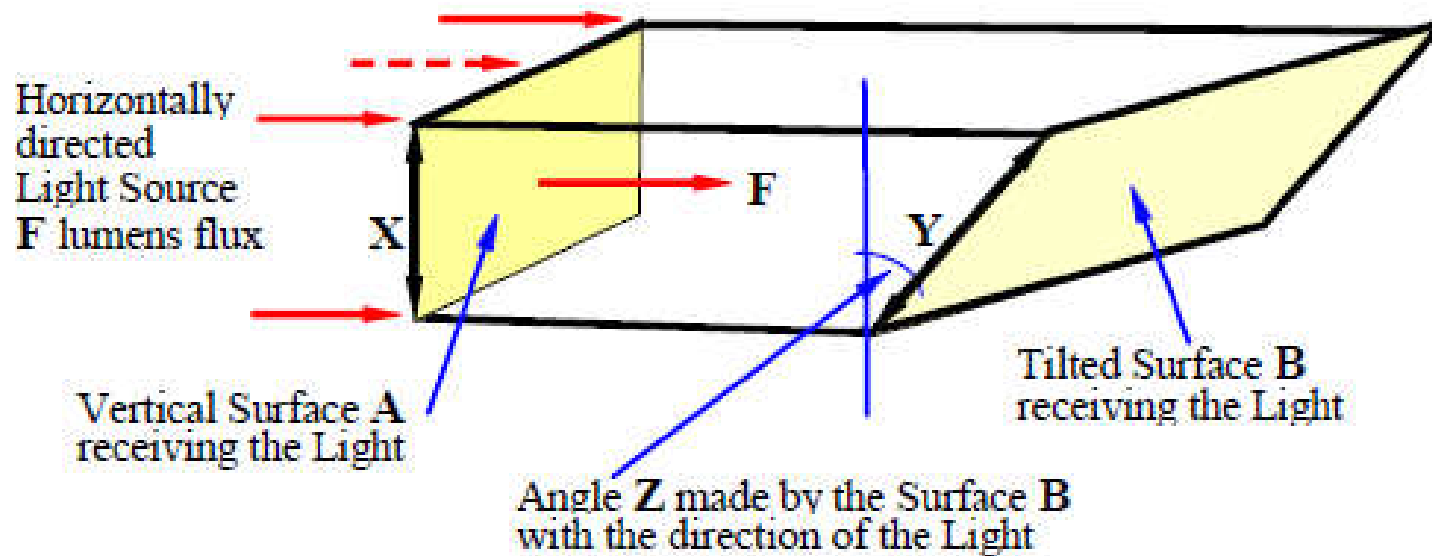

The Areas A and B are proportional to the lengths of their sides X and Y

$$A / B = \cos(Z) \quad B = A / \cos(Z) \quad \text{Illuminance } E_A = F / A$$

$$\text{Illuminance } E_B = F / B = F / (A / \cos(Z)) = F / A * \cos(Z) = E_A * \cos(Z)$$

$E = I / D^2$ when the incident angle is 0 degrees.
The general equation becomes $E = I / D^2 * \cos(Z)$

Light Source Intensity = I Candelas
 $E = I / D^2$

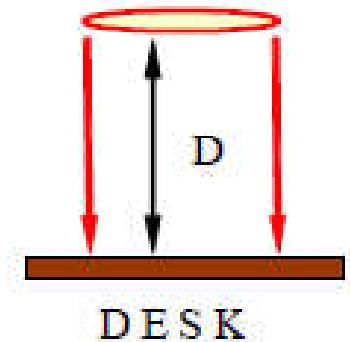

Light Source Intensity = I Candelas

$$E = I / D^2 * \cos(Z)$$

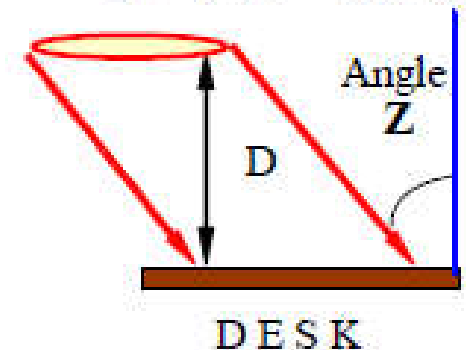

Cosine Values of Angles

0	6	12	18	24	30	36	42	48	54	60	66	72	78	84	90
1.000	0.995	0.978	0.951	0.914	0.866	0.809	0.743	0.669	0.588	0.500	0.407	0.309	0.208	0.105	0.000



Point-by-point method

- Video:

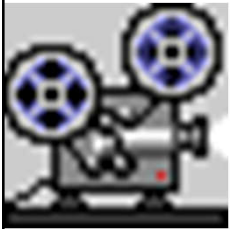

- Lighting Point by Point (5:08)

- <https://youtu.be/C8ZKNOvDmCQ>

- Limits for using point by point method:

- Maximum physical dimension of the surface under design is not larger than $1/5$ th the mounting height above the evaluation point
 - Does not apply to a surface of infinite length

Point-by-point method



- **Computer software** can be used to perform numerical point-by-point calculations of direct or reflected light incident on any real surface or imaginary plane
 - The results can be used to predict or quantify the distribution of artificial or natural light in any environment (=> lighting simulation)
 - Brightness of room surfaces & patterns of light on the ceiling, walls & floor
 - Also lighting quality & visual performance

Point-by-point method



- Two calculation techniques when simulating a lighting application
 - Direct Calculation Method
 - A simplified technique when reflected light need not be considered in the results; often used in exterior lighting applications e.g. road & sports lighting
 - It cannot be rendered
 - Full Radiosity Method
 - Accurate computation of interreflected light; for interior lighting applications or when rendering is desired

Two calculation techniques for simulating a lighting application

Direct calculation

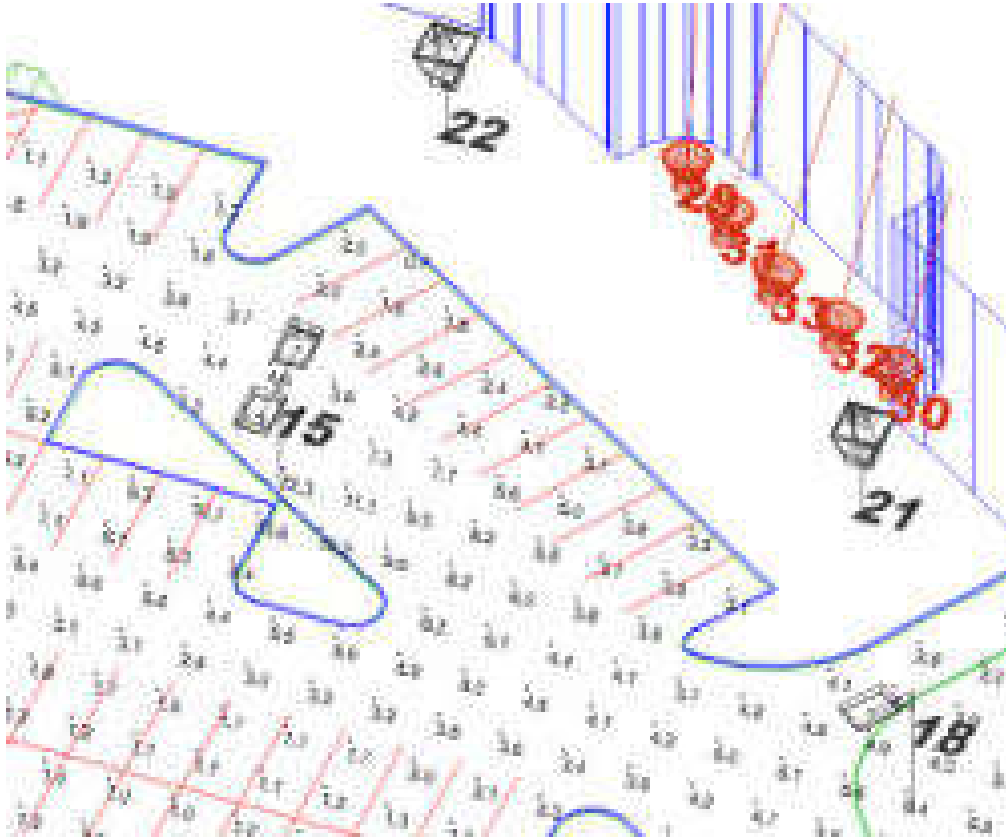

Full Radiosity calculation



Lighting calculations & simulation in Revit BIM using ElumTools

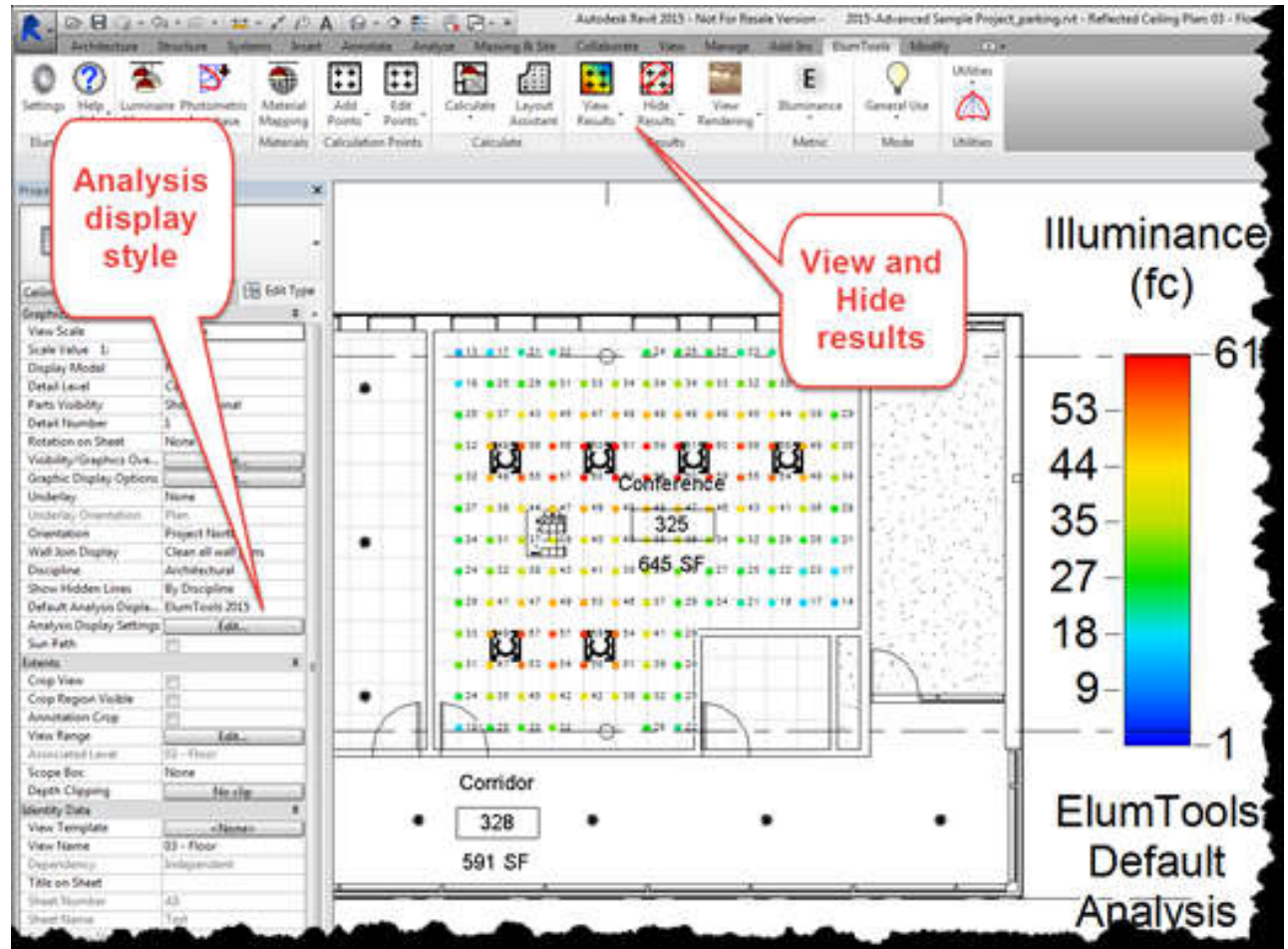
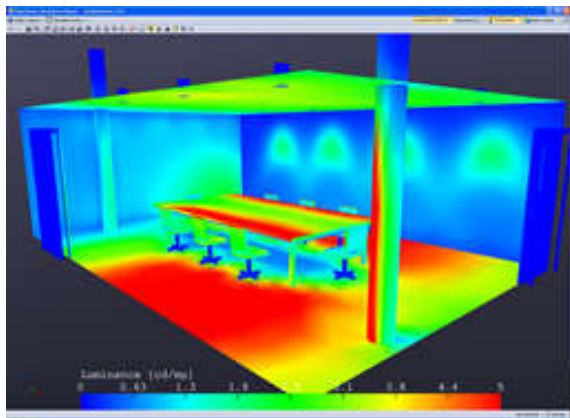
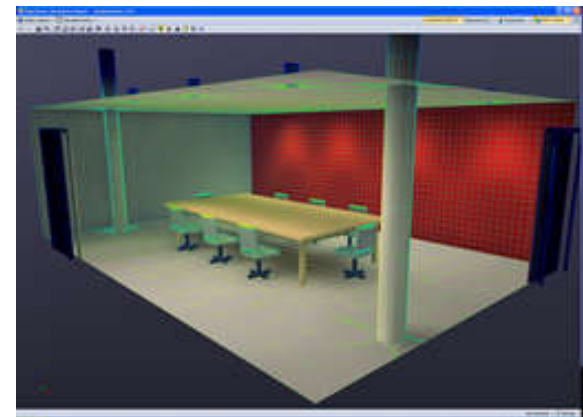
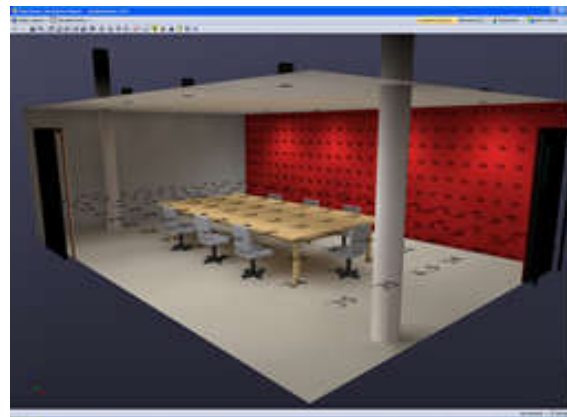

Using isolines & spatial maps to evaluate the gradient of light across a workplane or surface

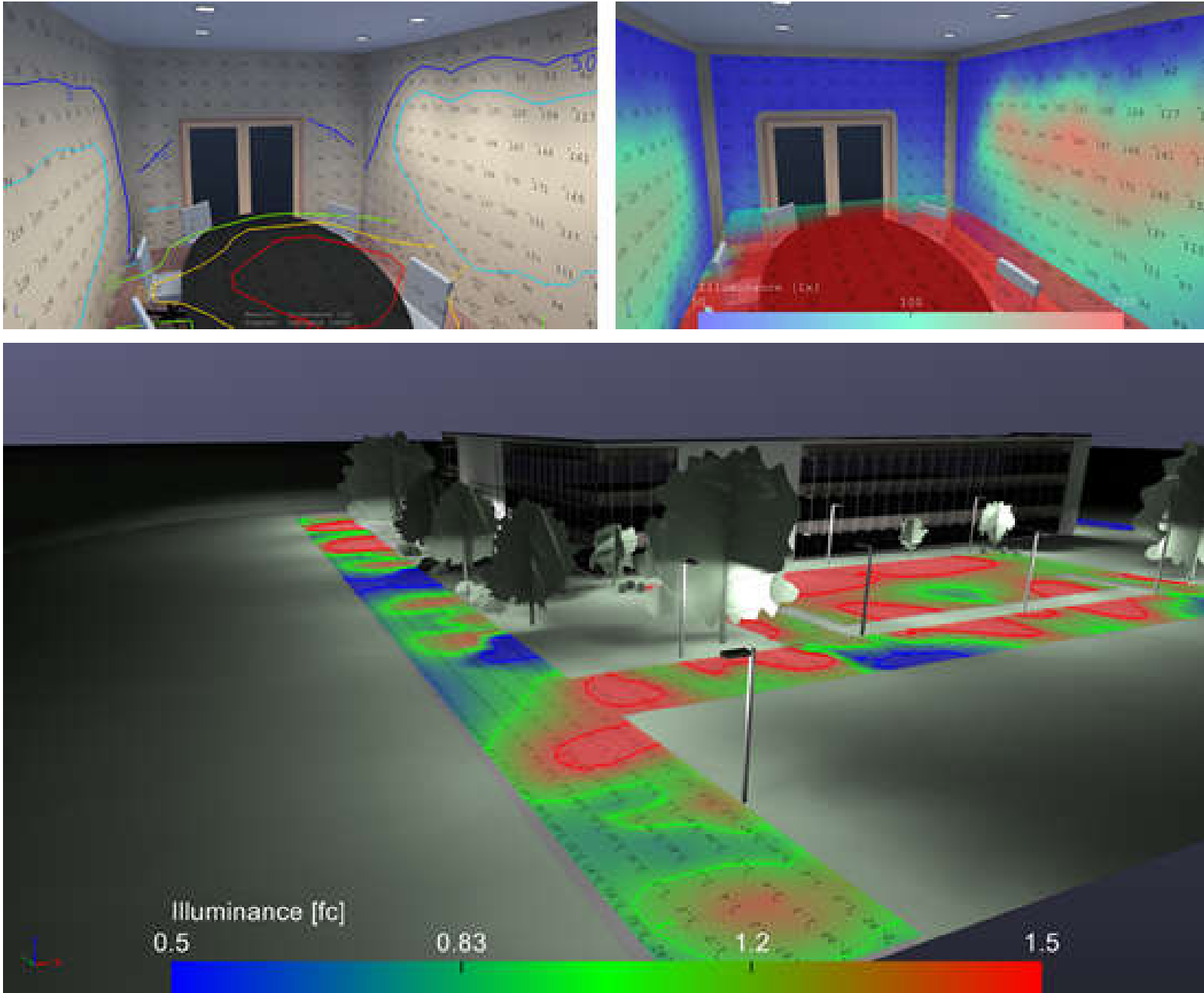

Point-by-point method



- Examples of the impact on lighting with differing techniques of lighting distribution inside interior spaces
 - <https://iarc.uncg.edu/elight/learn/design/la.html>
 - Uplighting
 - Downlighting
 - Semi-indirect lighting
 - Semi-direct lighting
 - Wall washing, wall grazing
 - Slot lighting



Daylight calculations



- Daylight factor (DF)

- To assess daylight availability & impact
- Expresses as a percentage the amount of daylight available inside a room (on a work plane) compared to the amount of unobstructed daylight available outside under overcast sky conditions

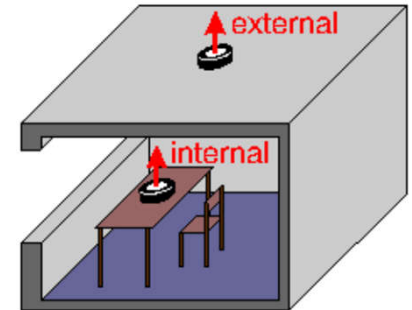

- Three components:

- Sky component (SC) – direct
- Externally reflected component (ERC)
- Internally reflected component (IRC)

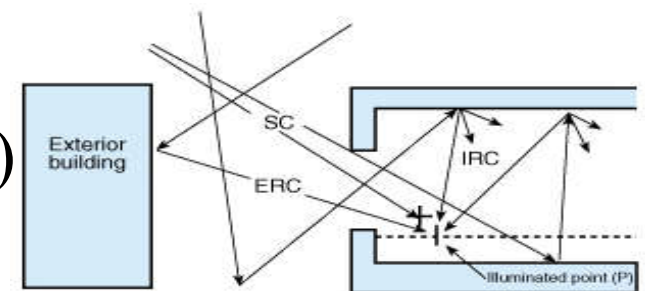
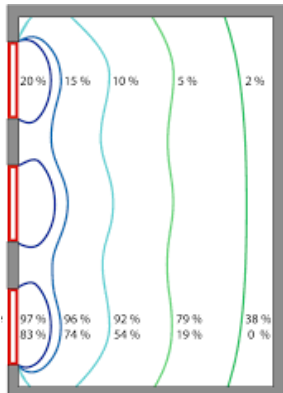

Luminance & daylight factor simulations

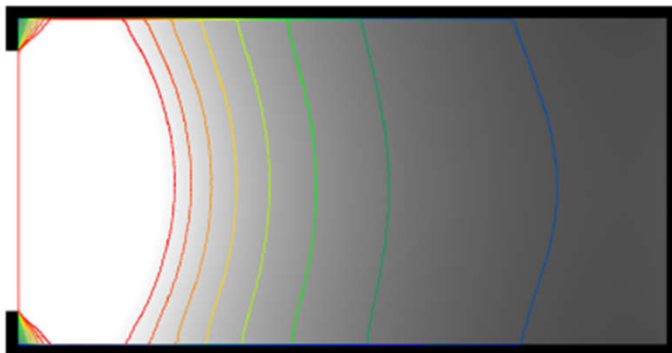
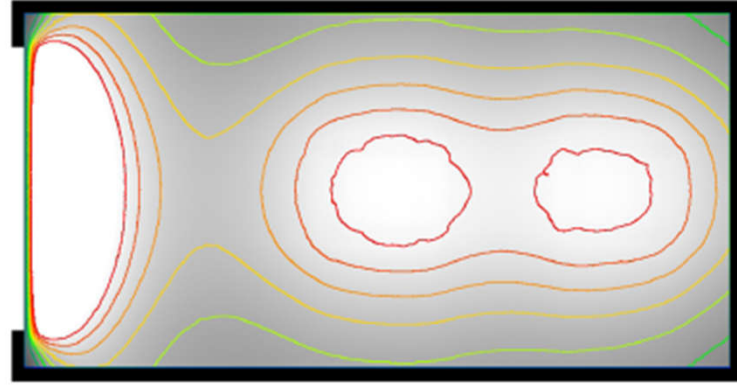
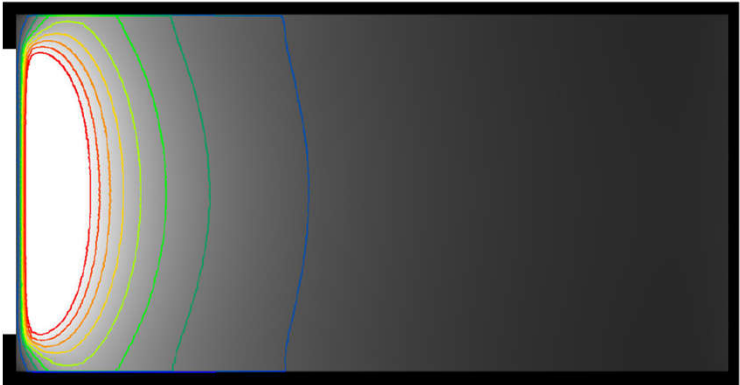
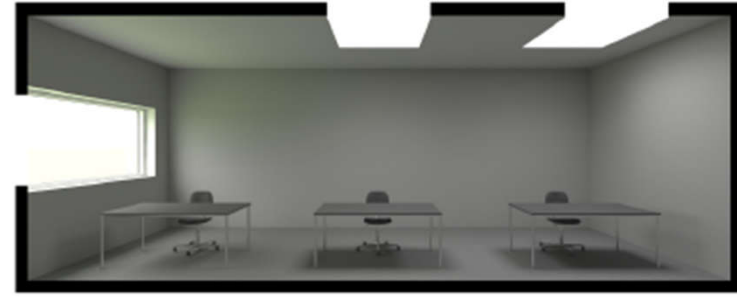
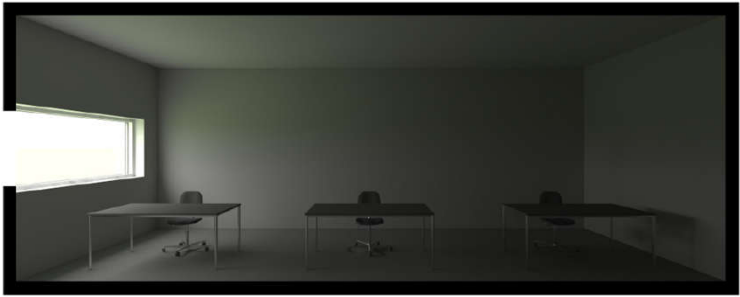

Video: Lighting Calculations:
Daylight Factor (4:46)

<https://youtu.be/F0IwXvwqI4g>

Daylight calculations



- Key building properties that determine the magnitude & distribution of daylight factor
 - The size, distribution, location & transmission properties of the facade & roof windows
 - The size & configuration of the space
 - The reflective properties of internal & external surfaces
 - The degree to which external structures obscure the view of the sky

Floor	(0.70)	Floor	(0.30)	Floor	(0.15)
Wall	(0.85)	Wall	(0.50)	Wall	(0.30)
Ceiling	(0.85)	Ceiling	(0.70)	Ceiling	(0.30)

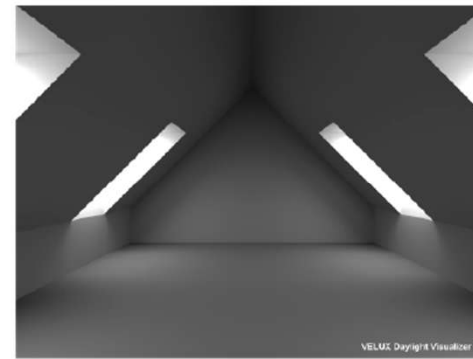
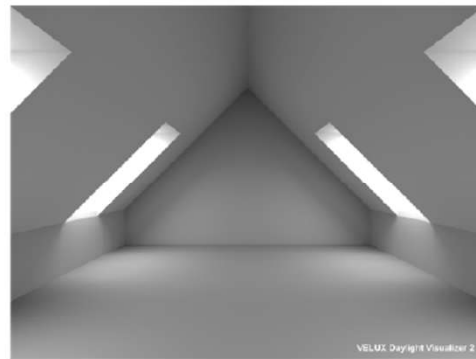
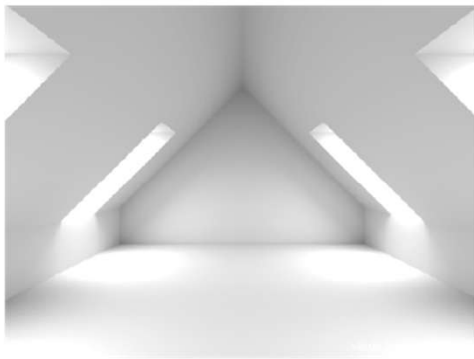
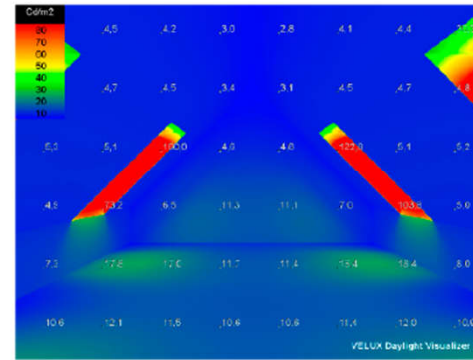
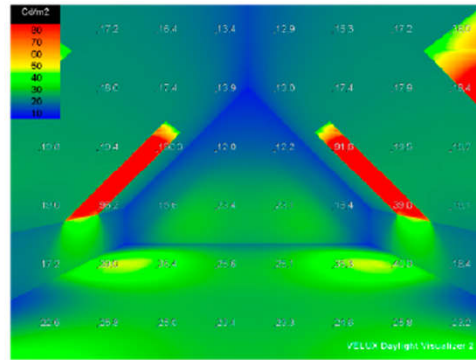
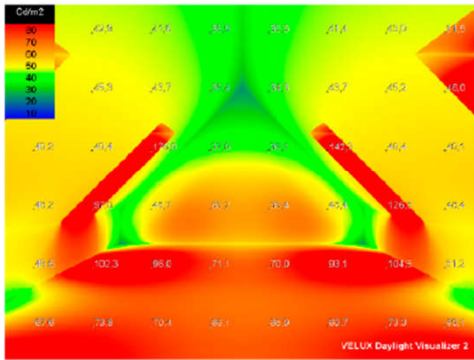

Effect of surface reflectance on daylight levels

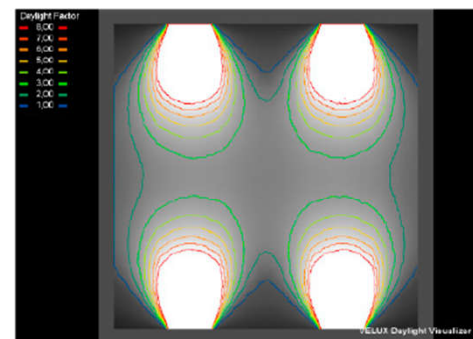
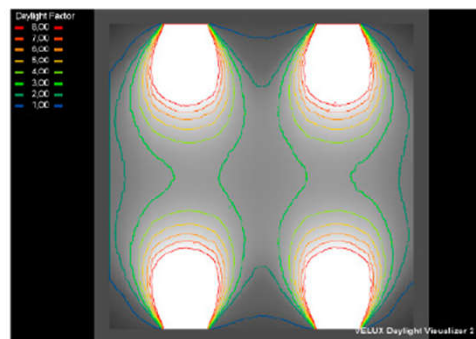
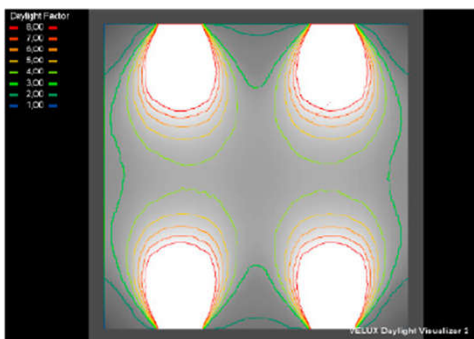

Average DF	6.41%	Average DF	5.60%	Average DF	5.24%
Median DF	4.68%	Median DF	3.86%	Median DF	3.49%
Uniformity Dmin/Dav	0.33	Uniformity Dmin/Dav	0.21	Uniformity Dmin/Dav	0.31

Comparison of daylight factor levels along the depth of the room

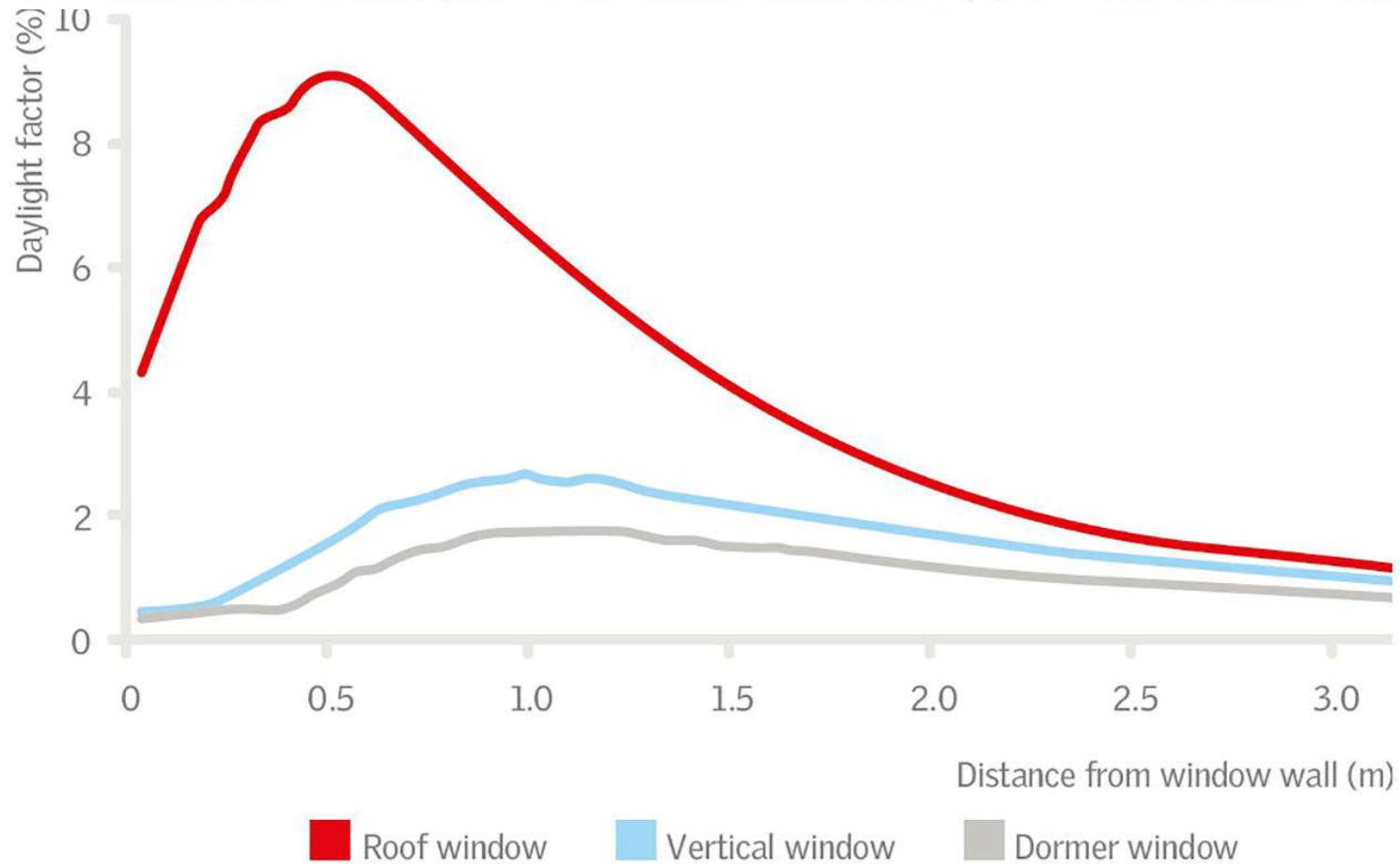
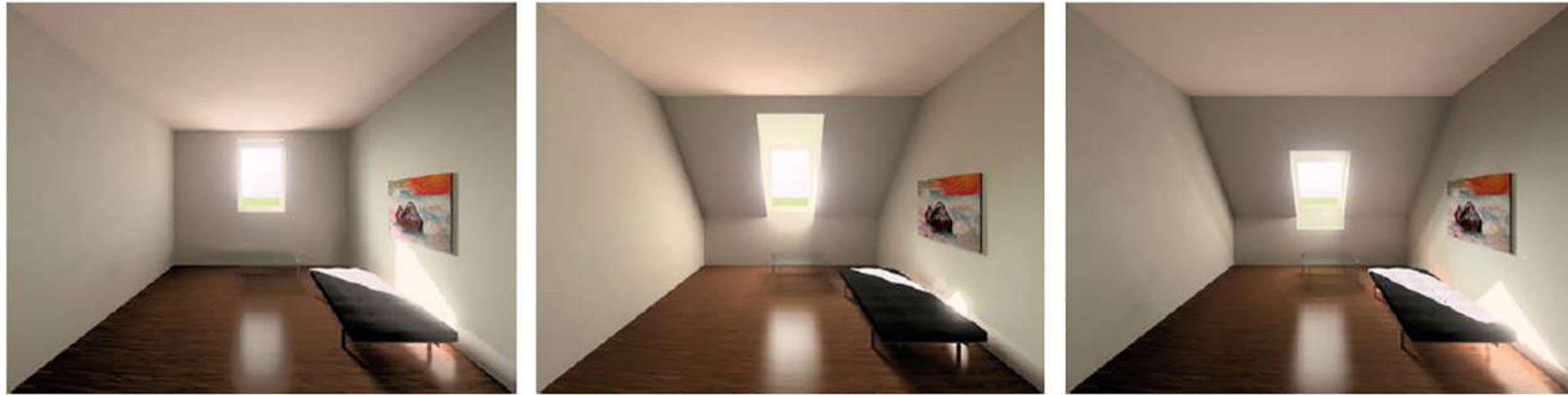

(Source: <https://www.velux.com/what-we-do/research-and-knowledge/deic-basic-book/daylight/daylight-with-roof-windows-flat-roof-windows-and-modular-skylights>)

Daylight calculations



- **Daylight autonomy (DA)**
 - Percentage of the occupied time when the target illuminance at a point in a space is met by daylight
 - A target illuminance of 300 lux & a threshold DA of 50%, meaning 50% of the time daylight levels are above the target illuminance
- **Useful daylight illuminance (UDI)**
 - Percentage of the occupied time when a target range of illuminances at a point in a space is met by daylight

Typical daylight autonomy visualisation

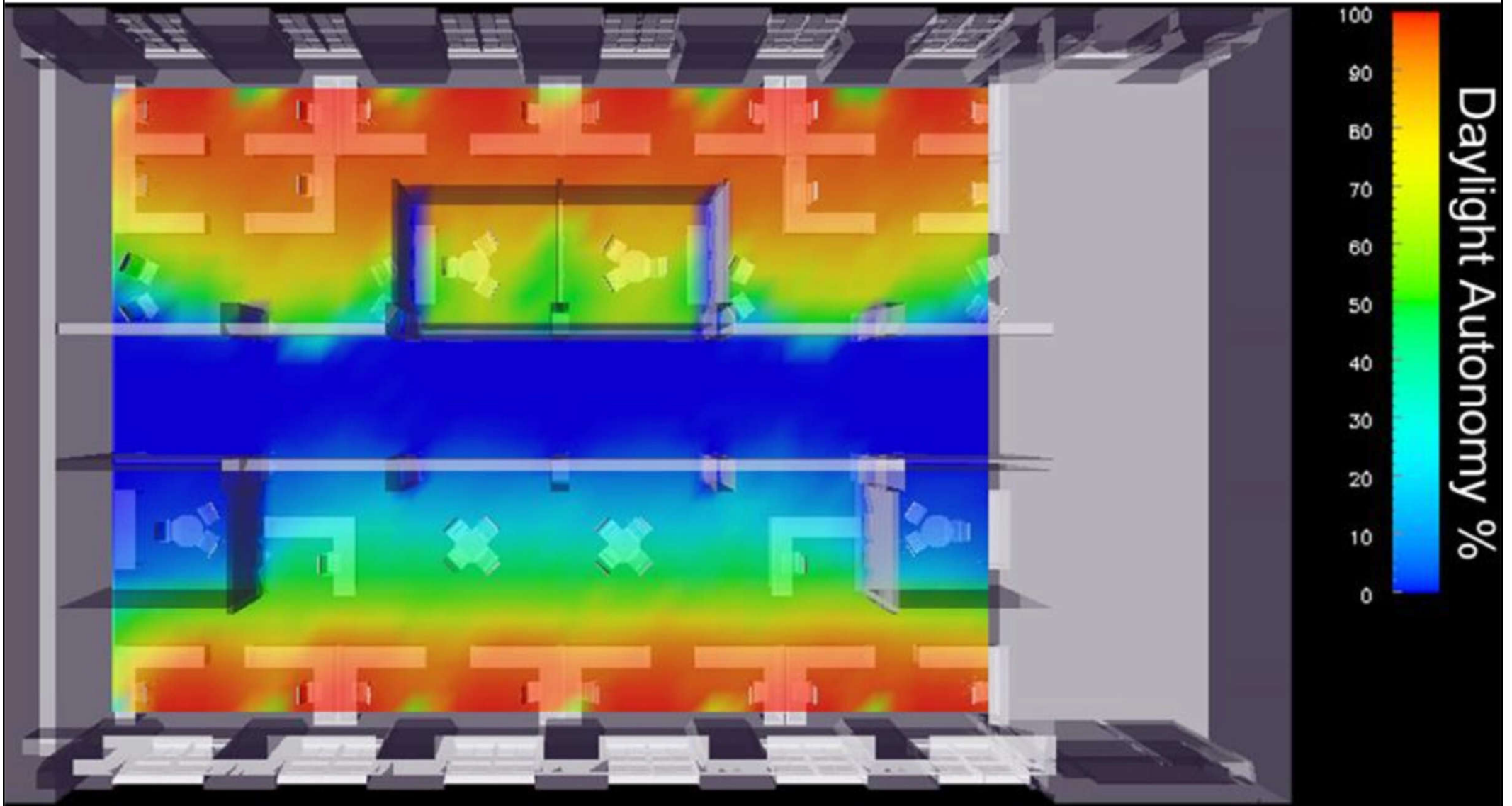

Daylight calculations



- Daylighting design & solar analysis
 - Manual methods
 - Shading mask & sun path diagram
 - Nomographs or charts (e.g. daylight protractors)
 - Scale model photometry (e.g. using heliodons)
 - Computer programs (e.g. RADIANCE, Lumen Micro, Lightscape, LightCAD)
 - On-site measurements (e.g. using lux meter) & observations

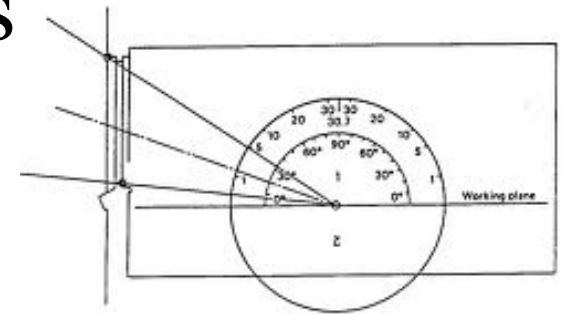

Daylighting design & analysis tools

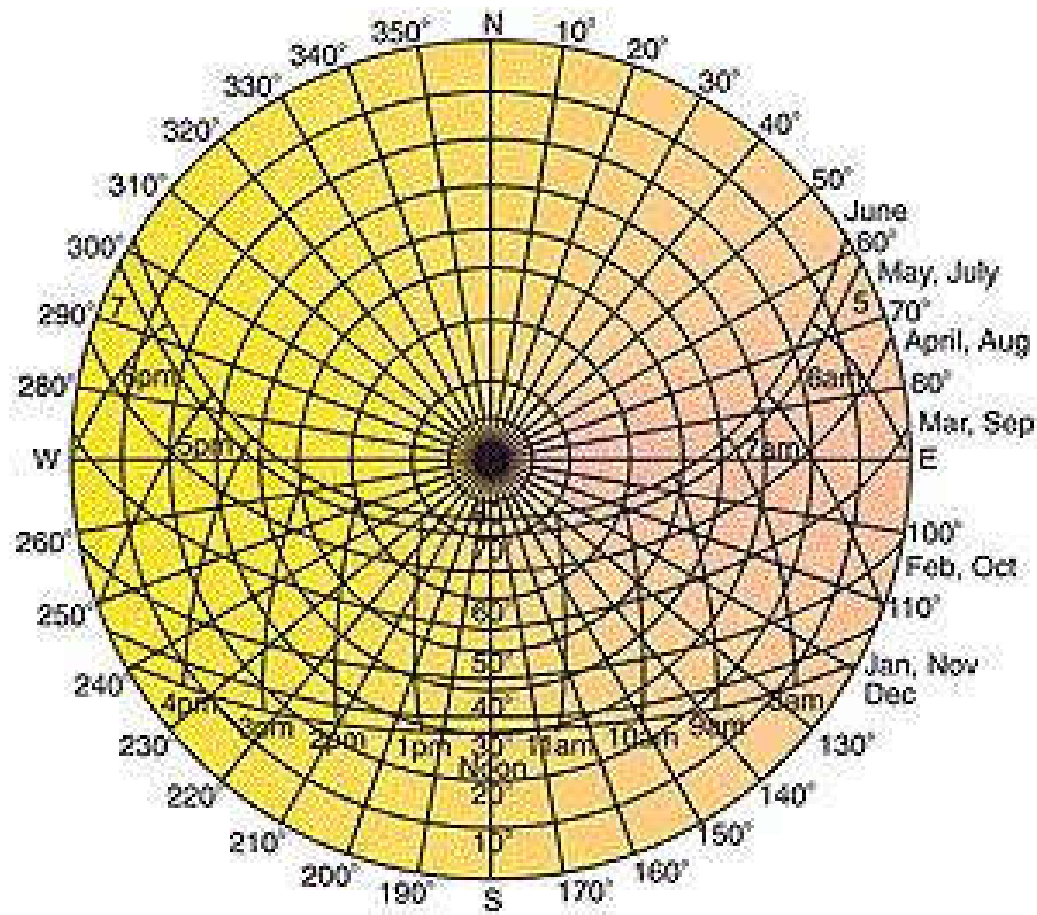

Sunpath diagram

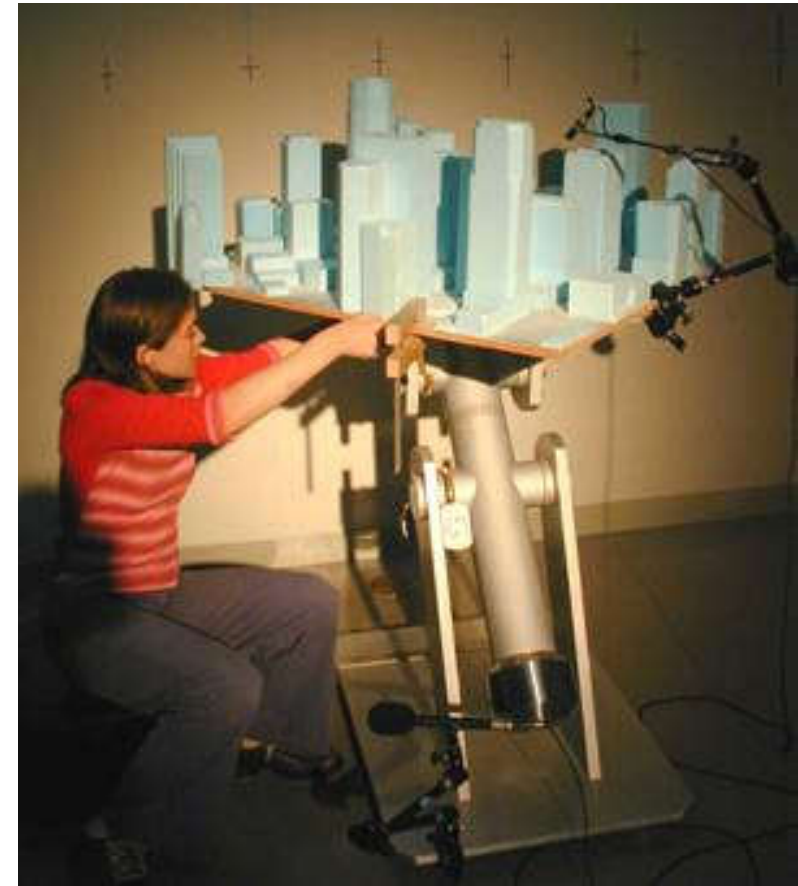

Heliodon studies

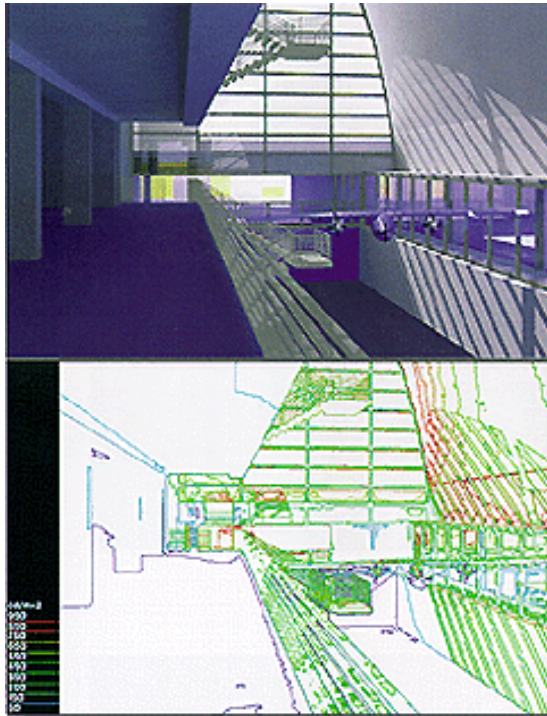

Daylight
simulation
using
RADIANCE

9:00am

12:00 noon

3:00pm

Cloudy:

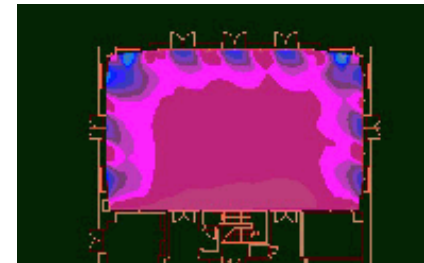
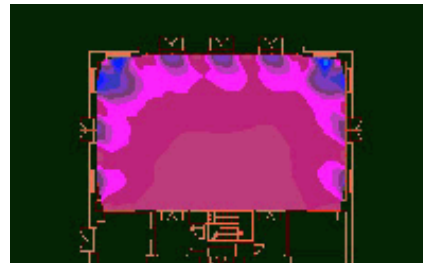
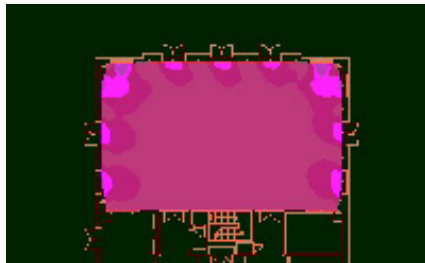

Sunny:

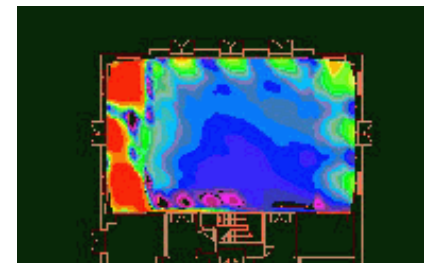
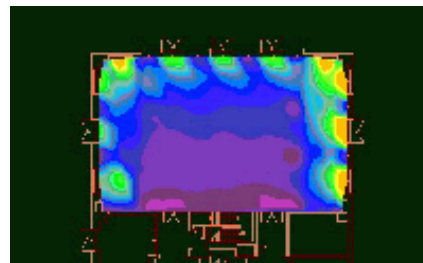
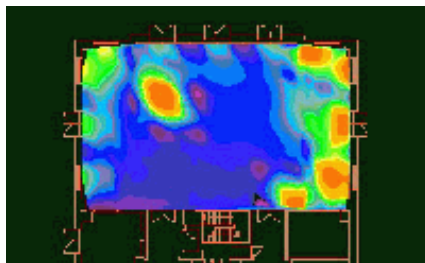

Daylighting
analysis

Details of daylighting calculations (for AGi32)

- Step 1 - Direct light (electric and daylight)
- Step 2 - Subdivide surfaces
- Step 3 - Exterior Daylight Radiosity
- Step 4 - Windows and Openings to Interior surfaces
- Step 5 - Interior Radiosity

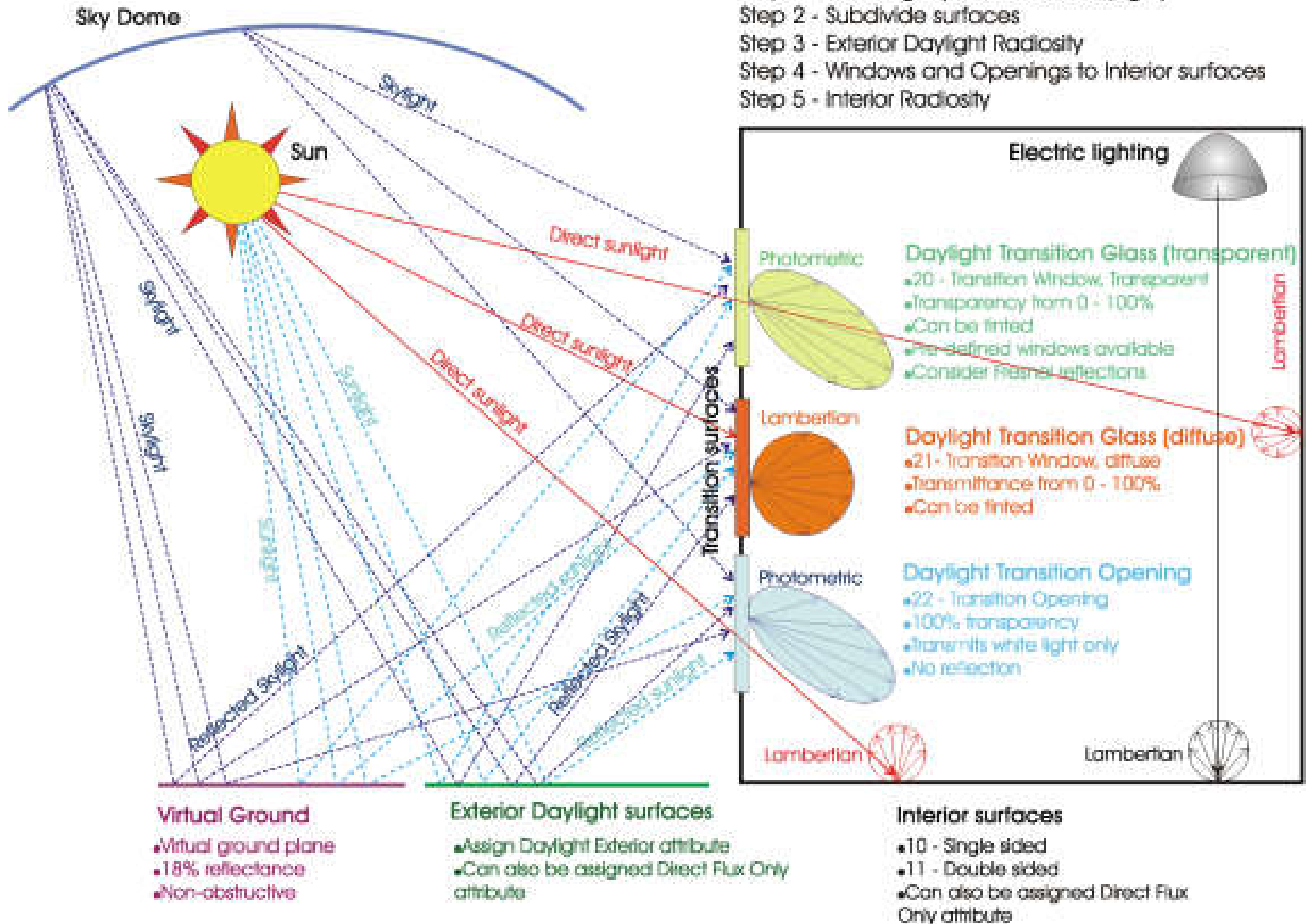

Daylight calculations



- Examples of the impact of architectural constraints on the lighting outcome in an interior space
 - <https://iarc.uncg.edu/elight/learn/record/1a.html>
 - Time of day
 - Location
 - Sky conditions
 - Room geometry



Luminance map showing the distribution of luminance values under overcast sky conditions

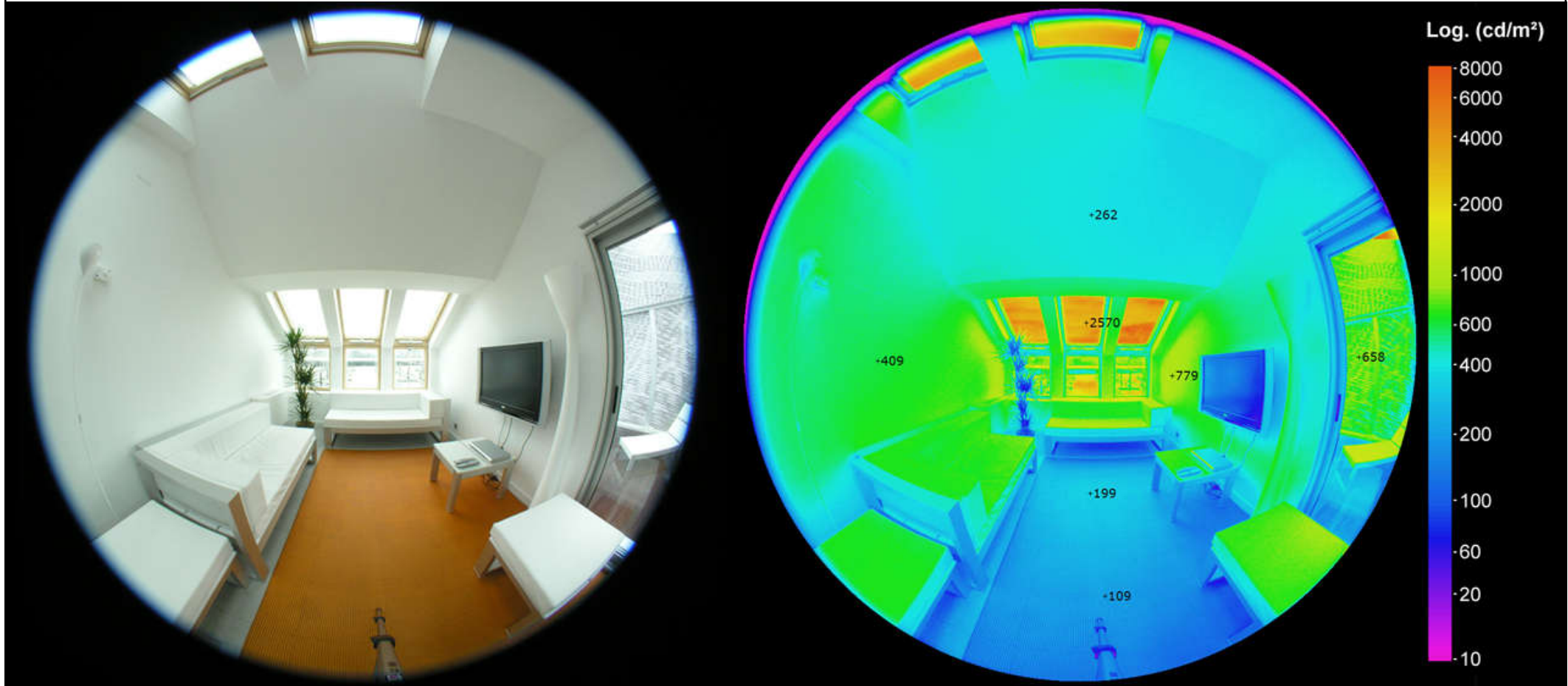

Preferable

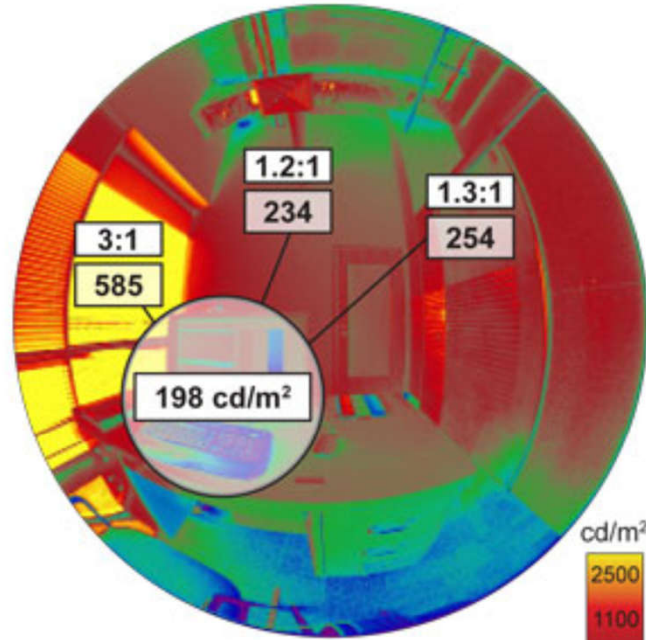

Example of glare analysis for daylight design

Just Disturbing Glare

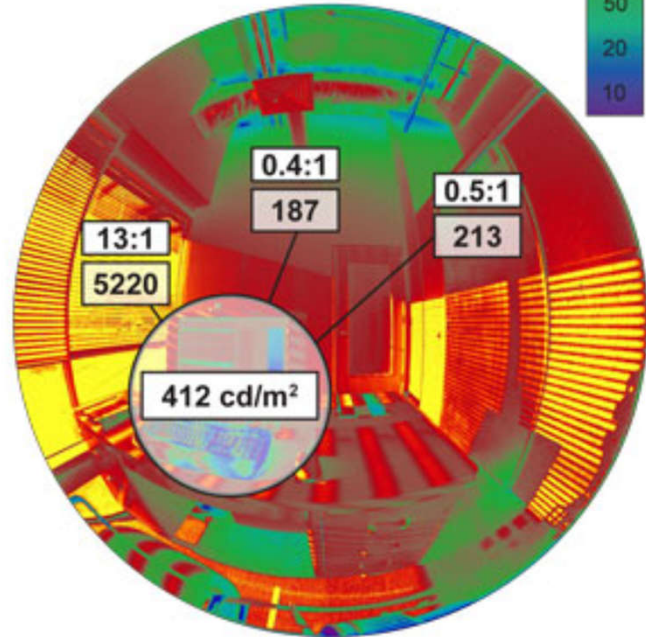

Other calculations



- Overshadowing of neighbouring buildings
 - Model shadow paths on an hourly basis for 21 March, 21 June, 21 September, 21 December to give an indication of transient overshadowing

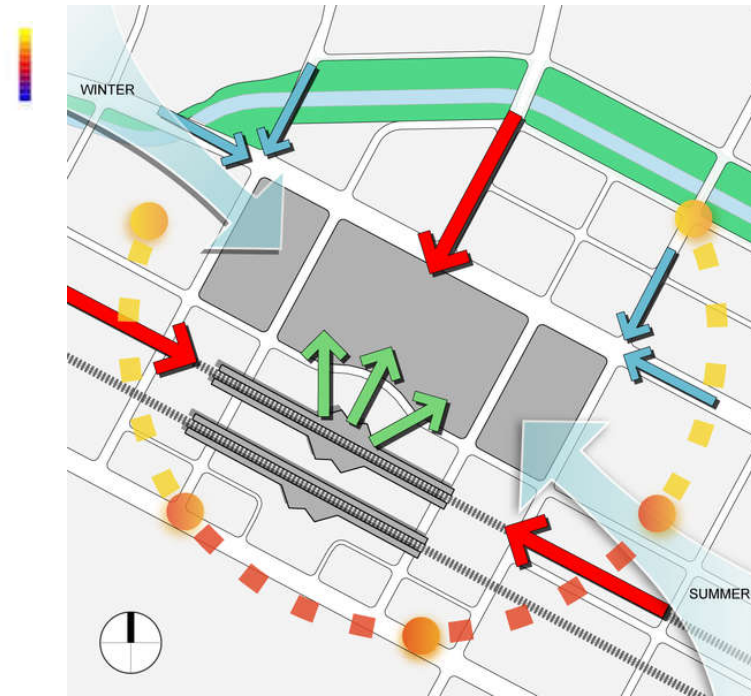
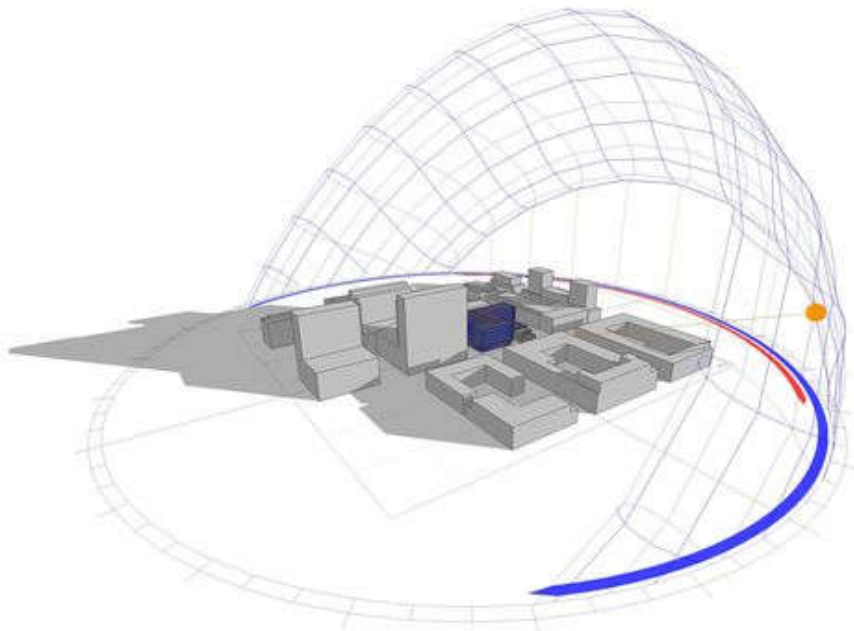

Solar studies & analyses

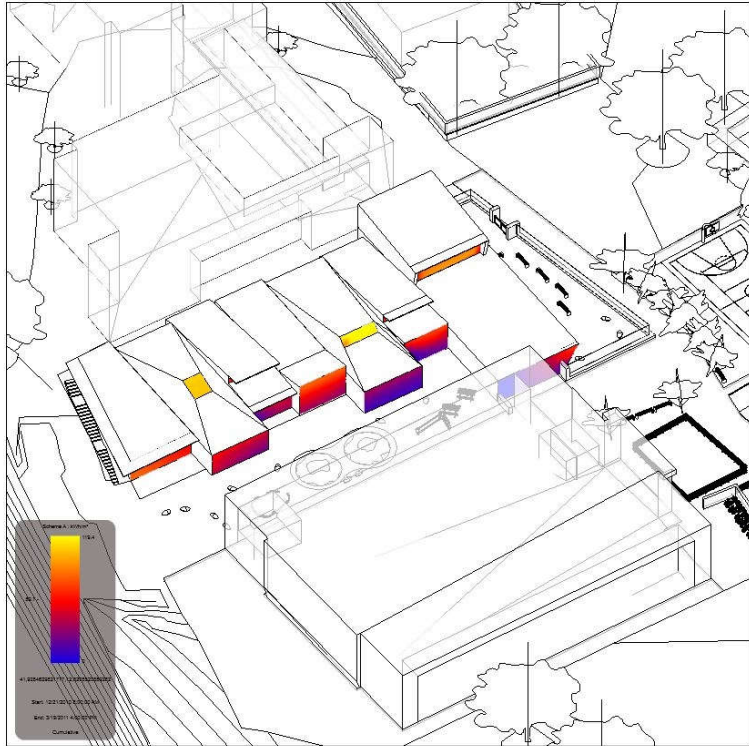
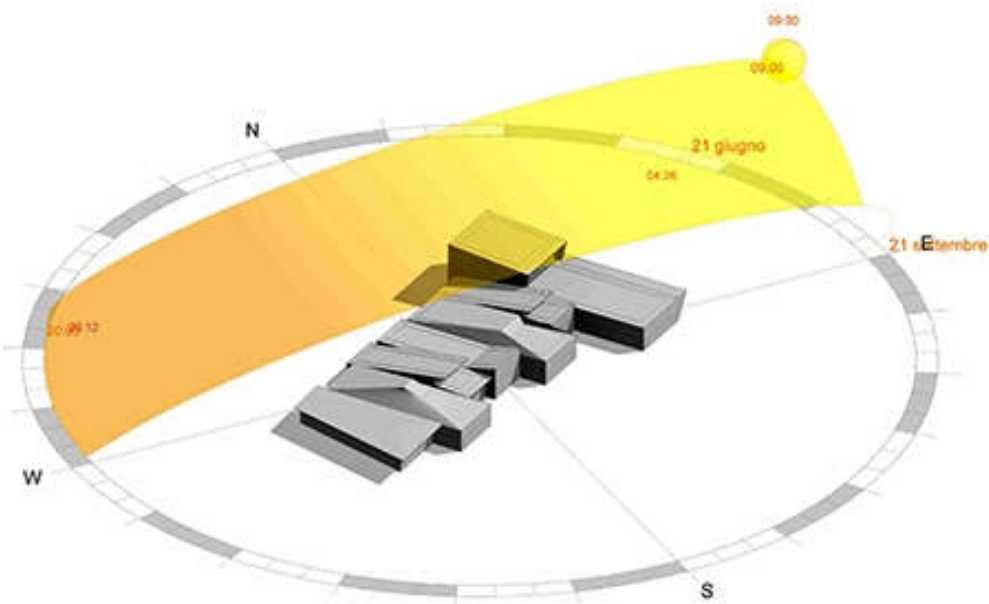

Solar insolation

(Source: Autodesk)

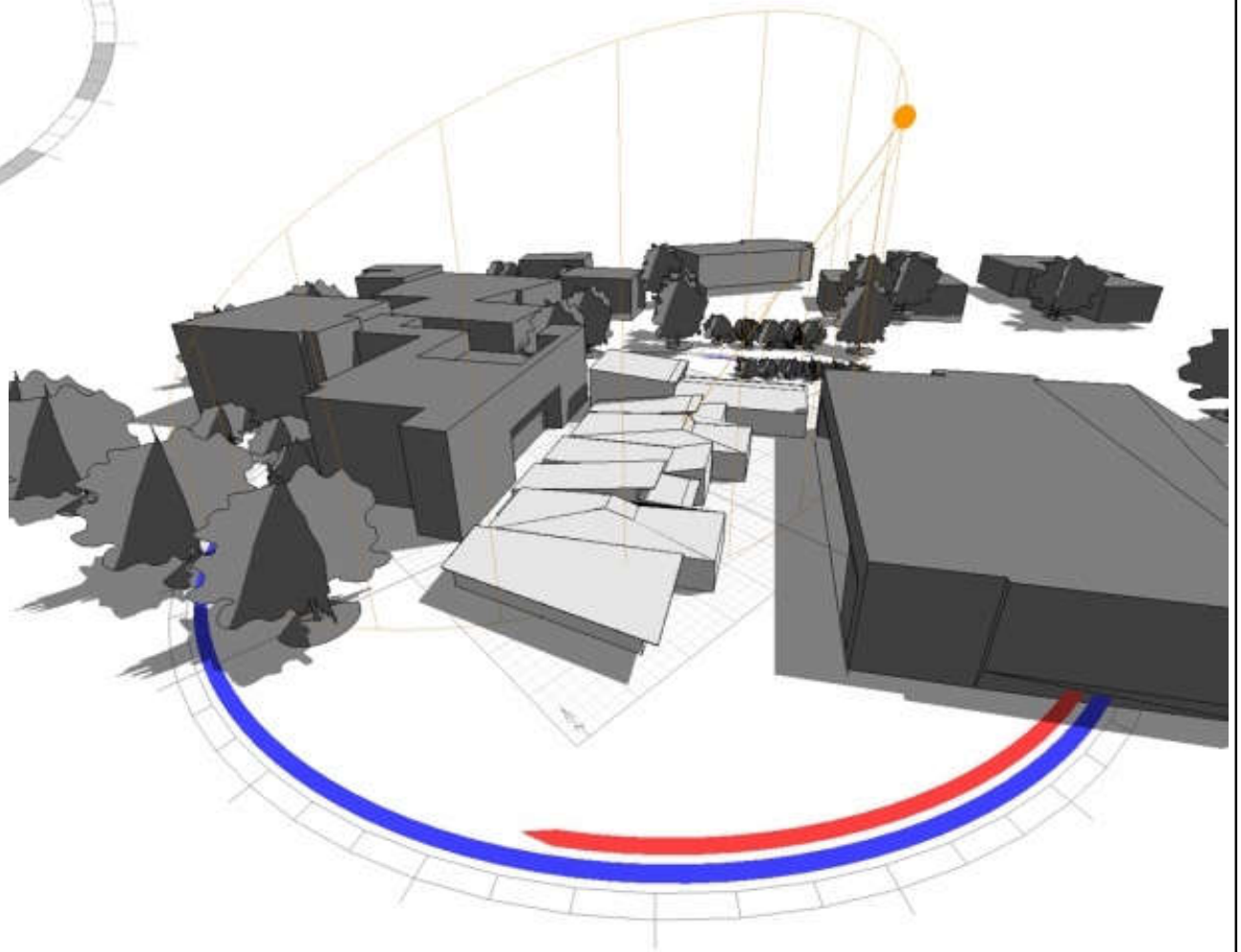

Solar radiation analysis (façade month)

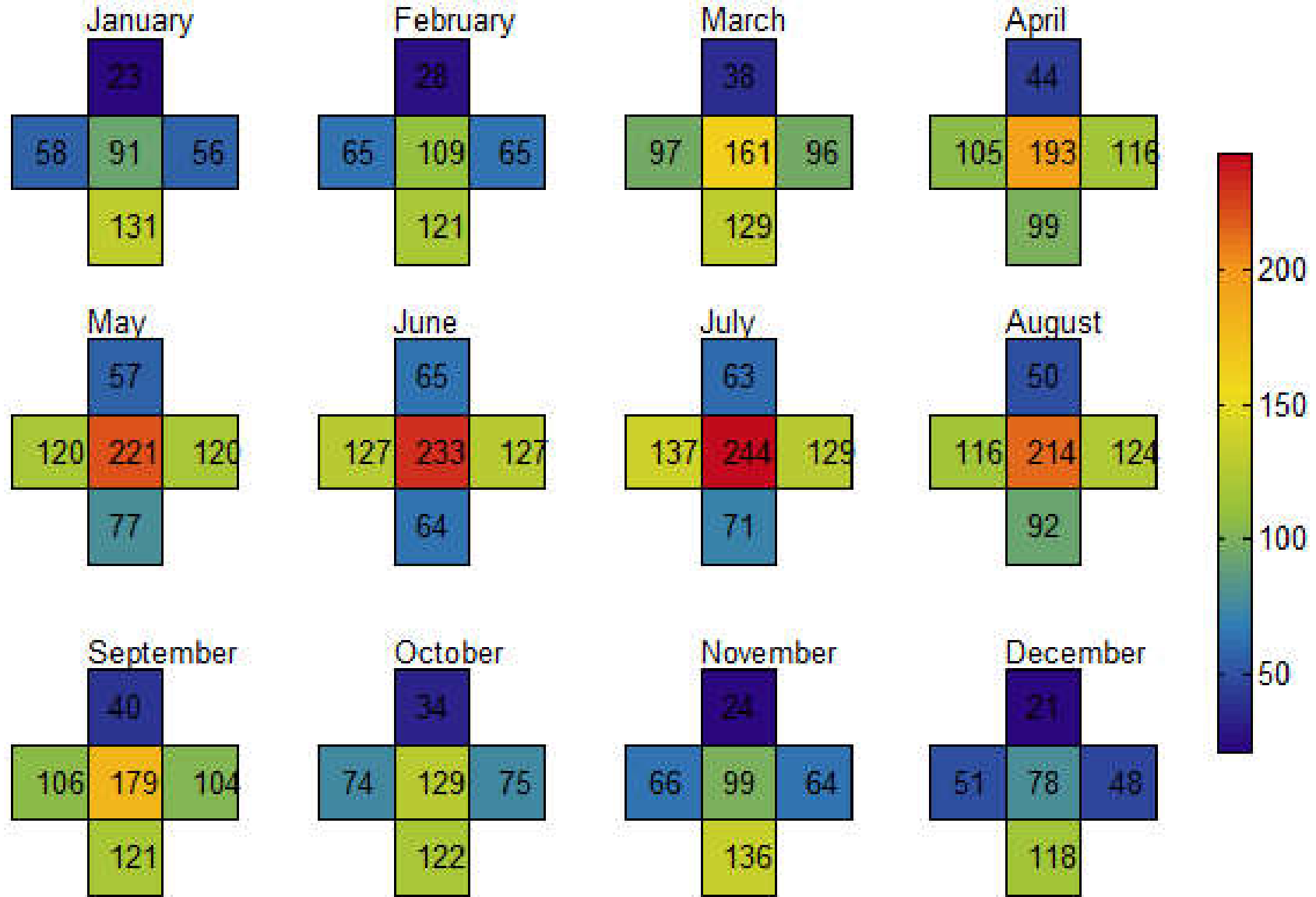
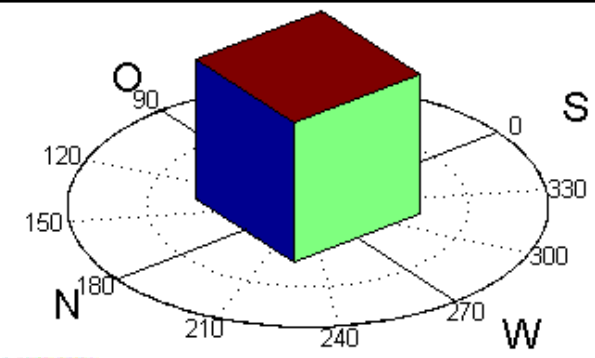

Global Radiation [kWh/m²*Month]

LOCATION: HONG KONG, SAR, CHN
Latitude/Longitude: 22.32° North, 114.17° East, **Time Zone from Greenwich 8**
Data Source: CityUHK-45007 450070 WMO Station Number, **Elevation 65 m**

SUN SHADING CHART

LEGEND

- **WARMHOT > 27°C**
(SHADE NEEDED)
1052 Hours Exposed
375 Hours Shaded
- **COMFORT > 20°C**
(SHADE HELPS)
432 Hours Exposed
362 Hours Shaded
- **COOL/COLD < 20°C**
(SUN NEEDED)
121 Hours Exposed
236 Hours Shaded

PLOT MONTHS:

WINTER SPRING

December 21 to June 21

SUMMER FALL

June 21 to December 21

Display Grid

Display Shading Calculator

Display Obstruction Elevation

Input Obstructions

Display Opposite Direction

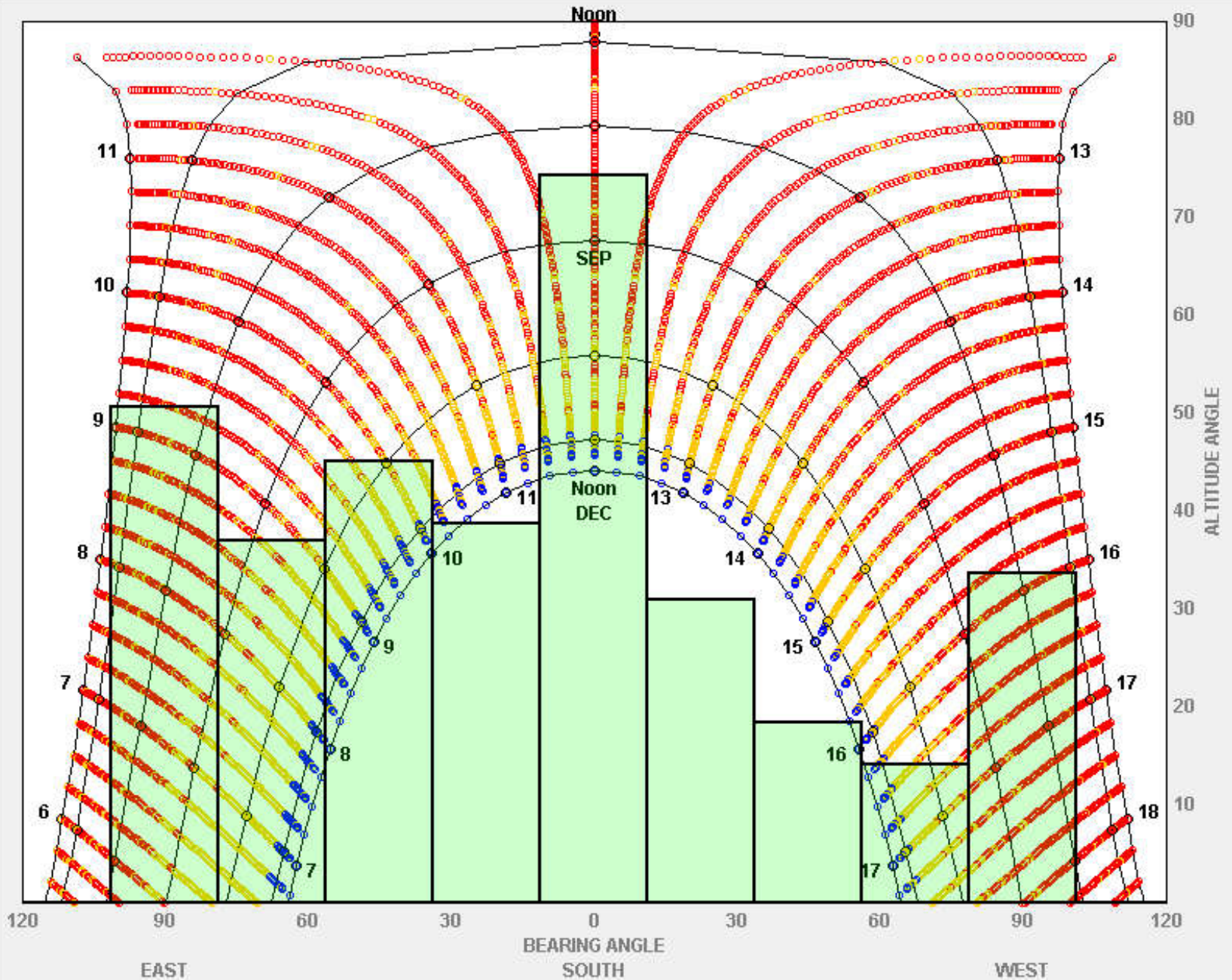

SUN CHART

LOCATION: HONG KONG, SAR, CHN
Latitude/Longitude: 22.32° North, 114.17° East, **Time Zone from Greenwich 8**
Data Source: CityUHK-45007 450070 WMO Station Number, **Elevation 65 m**

LEGEND

- WARM/HOT > 27°C
(SHADE NEEDED)
- COMFORT > 20°C
(SHADE HELPS)
- COOL/COLD < 20°C
(SUN NEEDED)

✱ GNOMON POSITION

PLOT MONTHS:

WINTER SPRING

○ December 21 to June 21

SUMMER FALL

● June 21 to December 21

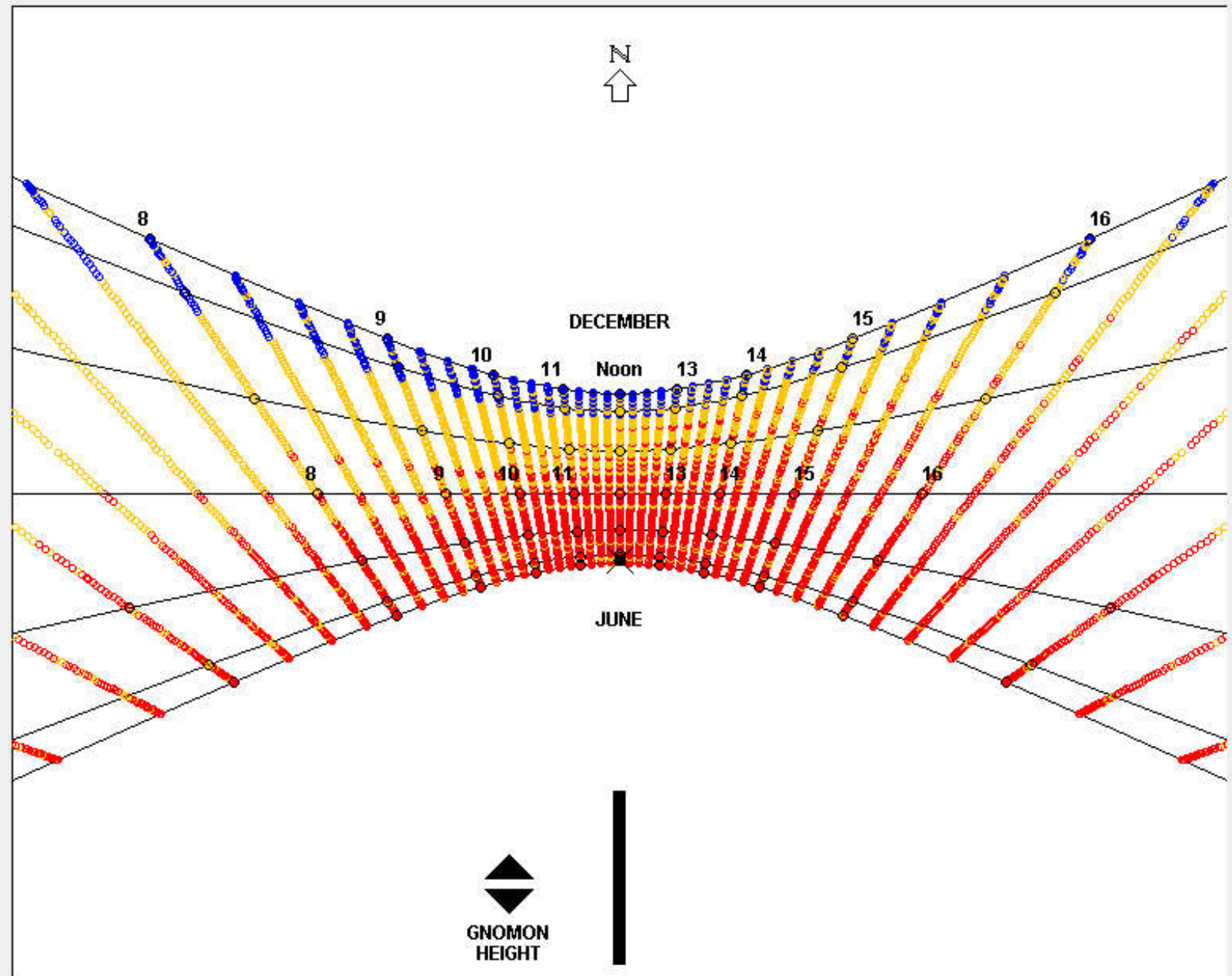

Other calculations



- Lighting to provide local emphasis
 - Emphasis or accent lighting is used to draw attention to an area or an object, e.g. a reception desk in an entrance area or a display in a shop
 - The amount of light needed to emphasise or draw attention to an object depends on the level of general lighting
 - Ratio of display light to general lighting:
 - ‘Subtle’ effect --- 5 : 1
 - ‘Moderate’ emphasis --- 15 : 1
 - ‘Strong’ emphasis --- 30 : 1

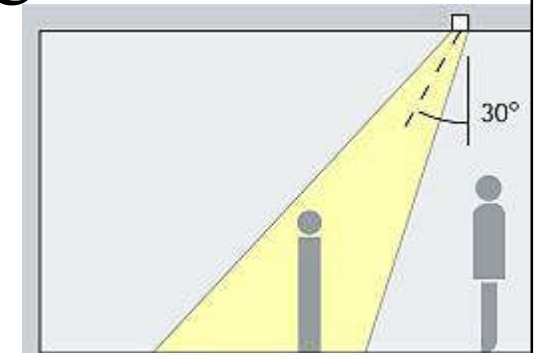

Other calculations



- Example: Use spotlight for local emphasis
 - Manufacturers usually provide information in a diagrammatic form showing the effect of a particular spot lamp at various distances
 - Width of the beam & either the illuminance at the beam centre or the average illuminance across the beam
 - Calculate the illuminance from a spotlight or any other small source using the ‘point source formula’
 - Wall washing: This uses luminaires that usually have an asymmetric beam shape. The manufacturers usually provide details of the luminaire layout & illuminance performance

Typical performance data for spotlight & wall-washing luminaire

Spotlight

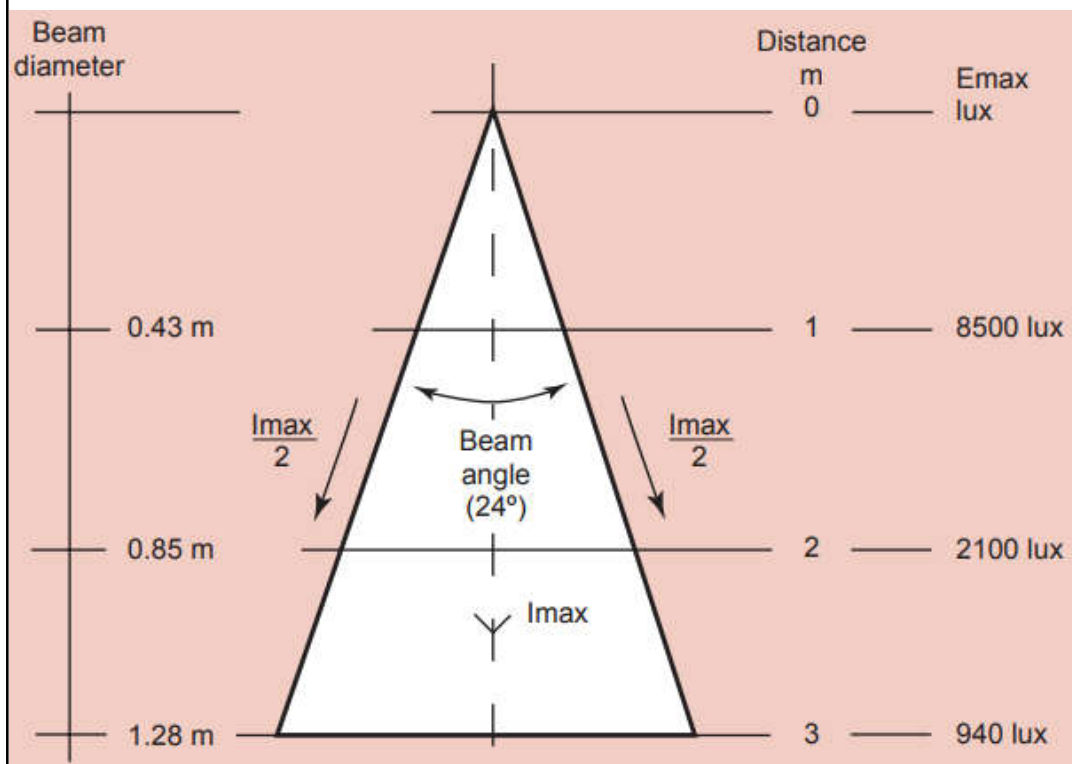

Wall-washing luminaire

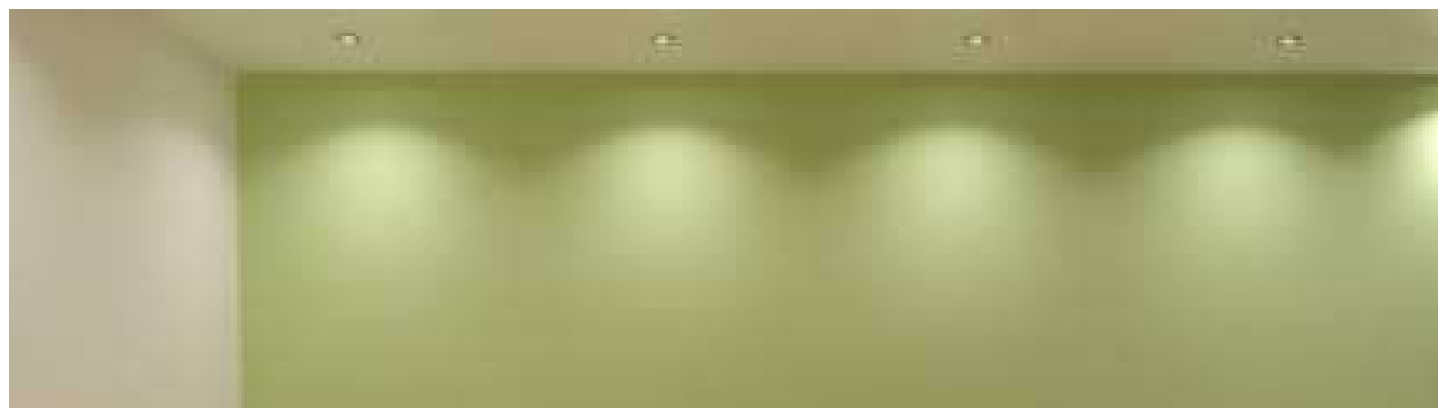
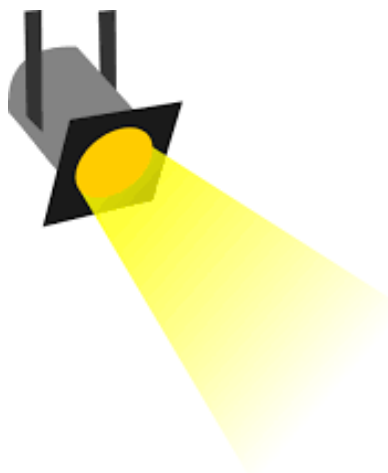
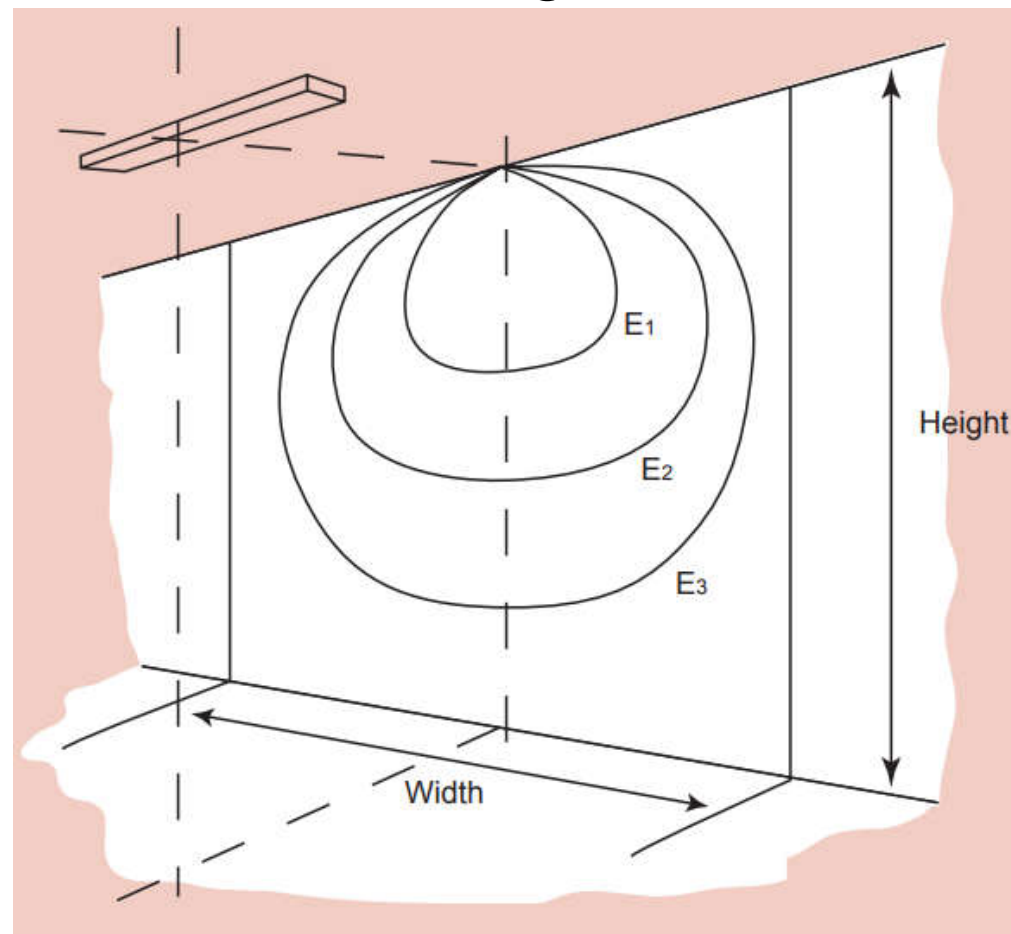

Other calculations



- Outdoor area lighting design, such as floodlighting, sports & road lighting
 - Area lighting Design Calculations - Part One
 - <http://www.electrical-knowhow.com/2013/01/area-lighting-design-calculations-part.html>
 - Point-by-point method
 - The beam-lumen (BL) method & light loss factor (LLF)

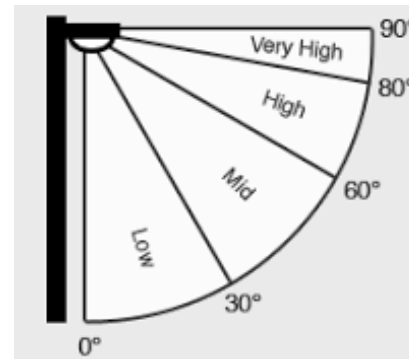

Other calculations



- Other lighting system related calculations:



- Checking for energy efficiency

- Local building/lighting energy efficiency code
- Average installed power density (W/m^2)

- Energy-saving payback calculations

- Demonstrate to a client that the additional cost of installing efficient equipment is worthwhile is by calculating payback period – the length of time before the savings match the extra initial cost
 - $\text{Payback} = (\text{the extra initial cost}) / (\text{annual cost savings})$
- After this period, the user has saved more than he has spent and continues to save money





Further Reading

- Lighting Design Calculation in a Building – Step by Step
<https://www.electricaltechnology.org/2017/03/lighting-design-calculation-in-building.html>
- Task Lighting Design
https://www.emsd.gov.hk/filemanager/en/content_764/Task_Lighting_Design.pdf
- The installer's guide to lighting design, Good Practice Guide 300
http://ibse.hk/IBTM5680/The_installers_guide_to_lighting_design.pdf