

IBTM 5680 Lighting Engineering

<http://ibse.hk/IBTM5680/>



Indoor Lighting Design

Ir Dr. Sam C. M. Hui

E-mail: sam.cmhui@gmail.com

<http://ibse.hk/cmhui/>

Sep 2024

Contents



- Overview
- Basic principles
- Design process
- Design factors & issues
- Glare control



Overview

- Video: What is lighting design? (4:13)

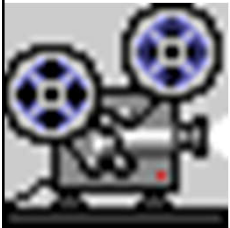

- <https://youtu.be/hqT4aIUaHfQ>
- Award winning Architectural Lighting Designer, Annette Hladio, discusses her views on lighting design
- She has an education in architectural engineering
- Galleries of lighting design portfolio by Annette Hladio:
 - <http://www.archltg.com/>





Overview

- Lighting design can have many different objectives
 - Determined by the client & the designer
 - The most common objective is to allow the users of a space to carry out their work quickly & accurately, without discomfort
- Design constraints
 - Such as financial & environmental concerns
 - Architectural integration, installation & maintenance issues



Considerations for lighting design

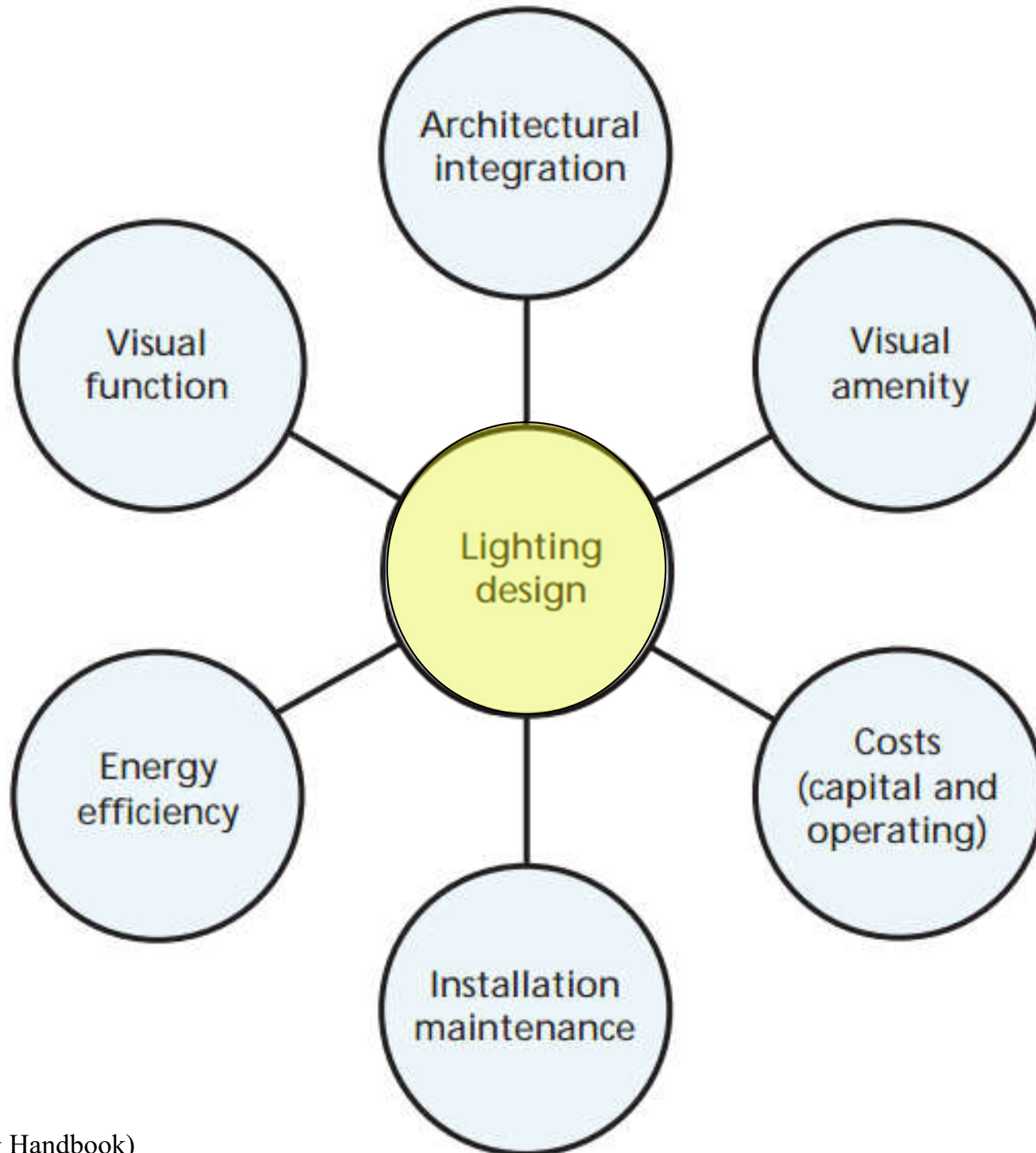



Overview

- A holistic strategy for lighting should consider:
 - Legal requirements & installation costs
 - Visual function
 - Visual amenity
 - Architectural integration
 - Energy efficiency & sustainability
 - Maintenance & flexibility
 - Appearance of the spaces & luminaires
 - Photopic or mesopic vision
 - Light trespass & sky glow (light pollution)



Overview

- Defining the lighting design project:
 - Lighting for a new space or retrofitting?
 - Need to correct existing lighting problems?
 - Change in the use of the space?
 - Desire to save energy and stretch the budget
- Opening assessment:
 - Meet with owner, occupants, architect, etc.
 - Identify legal constraints
 - Identify uses of space
 - Identify physical challenges, opportunities



Overview

- Examples of **indoor lighting design**:
 - Emergency lighting
 - Office lighting
 - Industrial lighting
 - Lighting for educational purposes
 - Lighting for museums & art galleries
 - Lighting for hospitals
 - Lighting for homes & hotels
 - Retail lighting

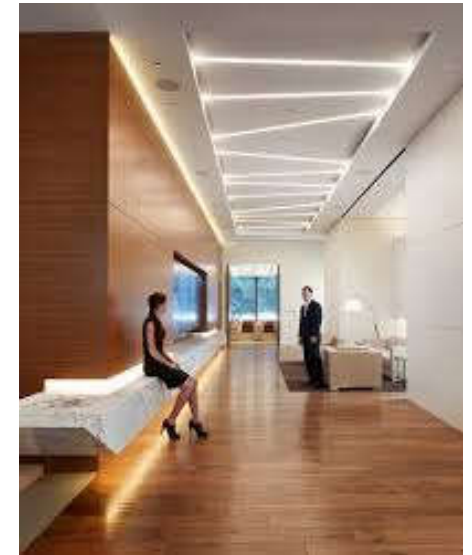



Overview

- Basic design decisions
 - Use of daylight (what role would daylight plays)
 - To provide a view out
 - To provide enough light to work by
 - To save energy
 - To provide lighting for particular tasks requiring very good colour rendering
 - To enhance the appearance of the space by providing meaningful variation in the lighting
 - Choice of electric lighting system
 - Such as general, localised & local lighting systems



Overview

- Basic design decisions (cont'd)
 - Integration
 - Within the space, architecture, interior design
 - With other services (e.g. fire, HVAC)
 - With daylight
 - With the surroundings





Overview

- General lighting practice:
 - Two objectives – good visual performance without discomfort
 - Two systems of measurement – photometry & colorimetry
 - Five criteria – Illuminance, luminance, uniformity, correlated colour temperature (CCT), colour rendering index (CRI), unified glare rating (UGR)
 - One location – the horizontal working plane
- Lighting design is all about people
 - Activity, experience, well-being



Overview

- “Lighting designer”
 - Determine how things will look & feel in a space
 - Understand & interpret the clients intent
 - Devise a suitable lighting concept & translate it into a plan (*creative vision*)
- “Illuminating/Lighting engineer”
 - Usually works from someone elses’ conceptual plan
 - Provides the “how to” or solves the problems....optical, visual or mechanical....of making the concept work

(* See also http://en.wikipedia.org/wiki/Architectural_lighting_design)

Basic principles



- Three main functions of lighting:
 - Ensure the safety of people
 - Facilitate the performance of visual tasks
 - Aid the creation of an appropriate visual environment (appearance & character)



Basic principles



- Vital principles of a good lighting proposal:
 - Light reinforces the idea, the vision or soul of a space
 - The proposed light is compatible with the function of the building & meets expectations regarding the use of its interior spaces
 - The proposed system must be technically & economically optimised and thus with a reasonable budget
- The lighting proposal is determined by light characteristics, colours, heights & scenes

Basic principles



- Lighting of interior as a whole is affected by:
 - General brightness
 - Patterns of light, shade, colour
 - Degree of glare
 - Modelling of people, objects & features
- Illuminance needed for the task depends on:
 - Visual difficulty & complexity of the task
 - Average standard of eyesight
 - Level of visual performance required



Basic principles



- Lighting design criteria
 - Luminous environment & luminance distribution
 - Illuminance & uniformity
 - Lighting directional effects
 - Colour aspects, variability of light
 - Glare, flicker & stroboscopic effects
 - Lighting of work stations with display screen equipment (DSE)
 - Maintenance factor
 - Energy efficiency requirements

Lighting distribution on the wall and the perception

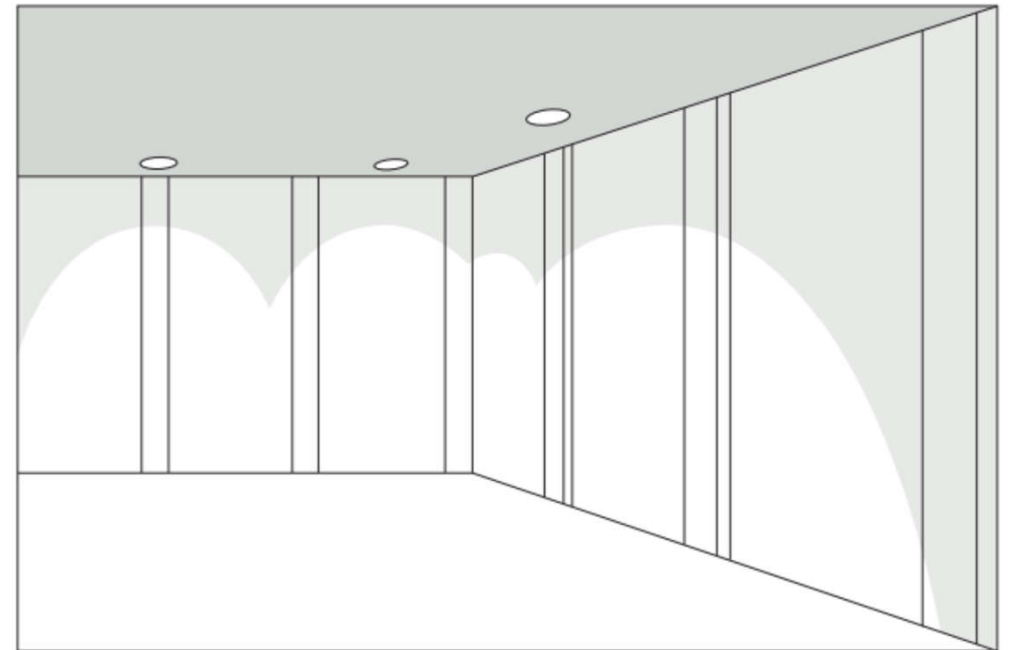
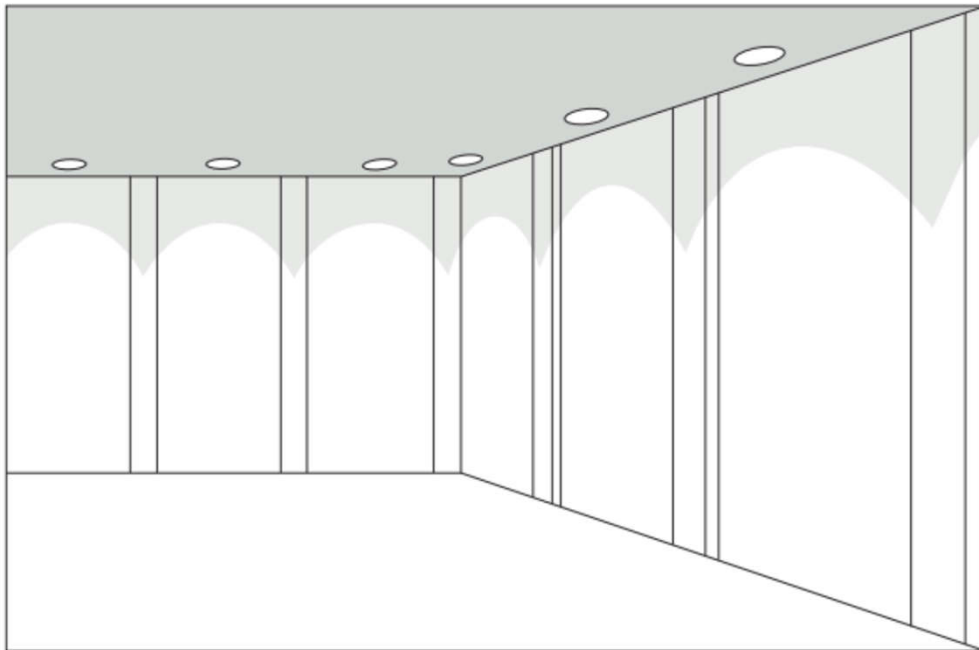
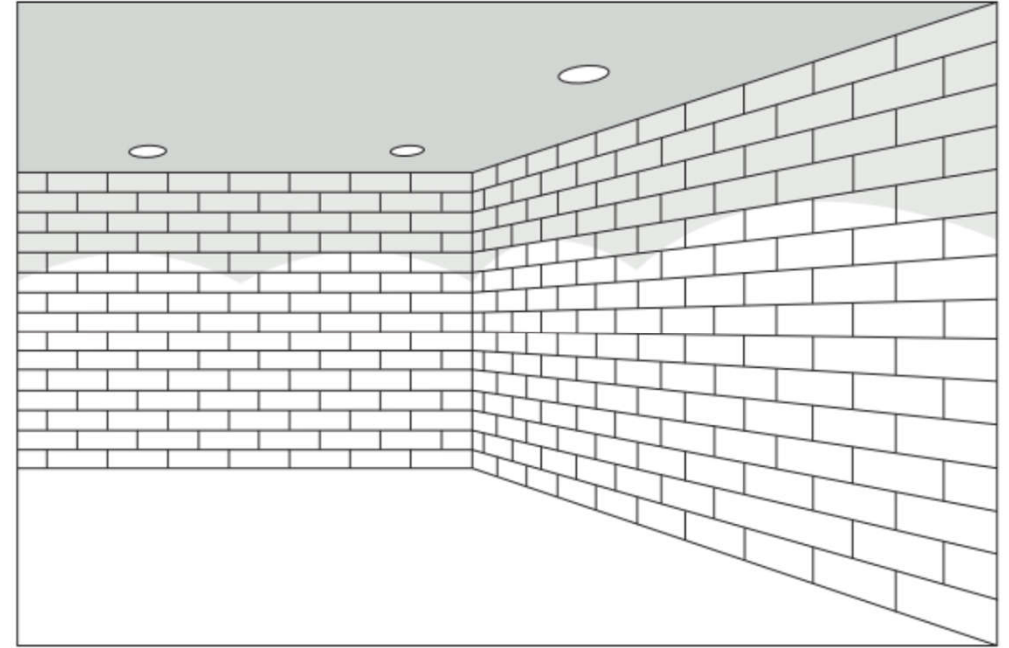
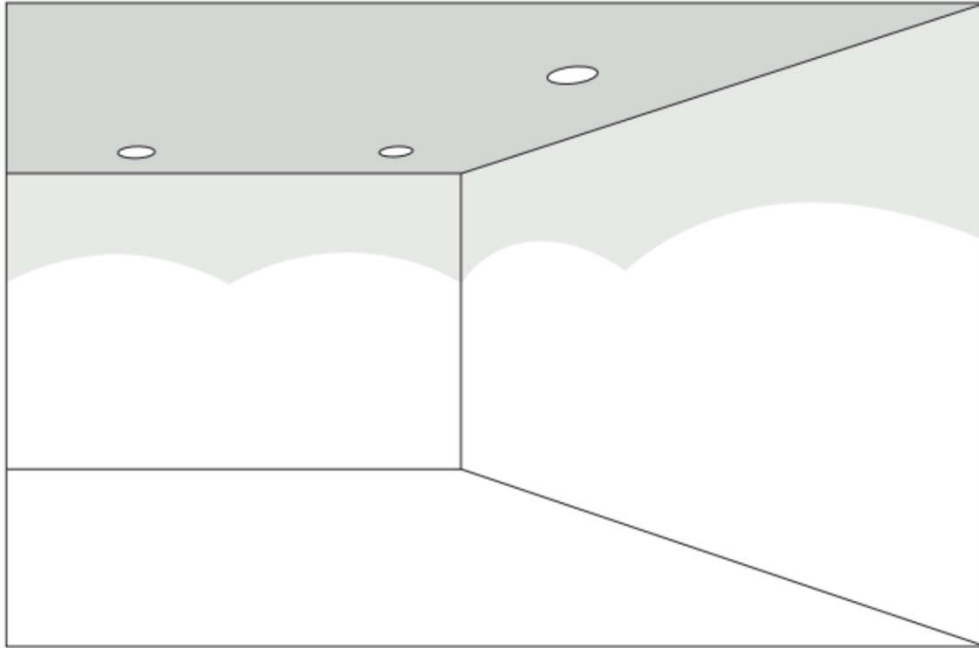

Basic principles

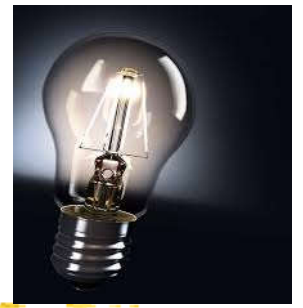

- Visual perception: how we see and perceive
 - <https://www.ereco.com/en/designing-with-light/lighting-knowledge/visual-perception/>
- Lighting interior spaces
 - Using light to divide rooms & accentuate architectural elements
 - 1. Forming functional zones
 - 2. Defining spatial borders
 - 3. Emphasising architectural features

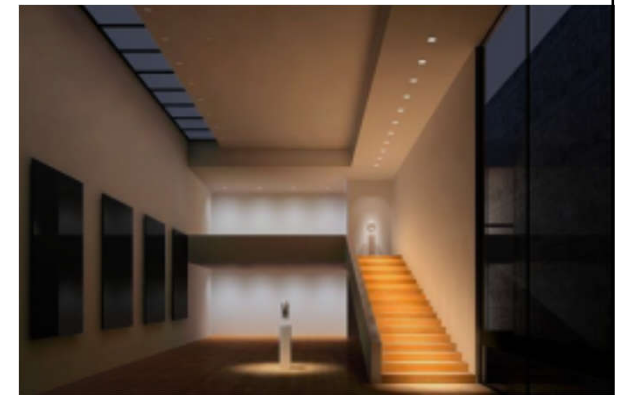

Basic principles



- Effect of lighting
 - On architecture (defines space & shows form)
 - On interior design (reveals texture & colour)
- Psychological effects of an environment are as important as the physiological
 - Good quality light to “see by” & to “feel by”
- Three main aspects to consider:
 - General lighting
 - Localised lighting
 - Local (task) lighting

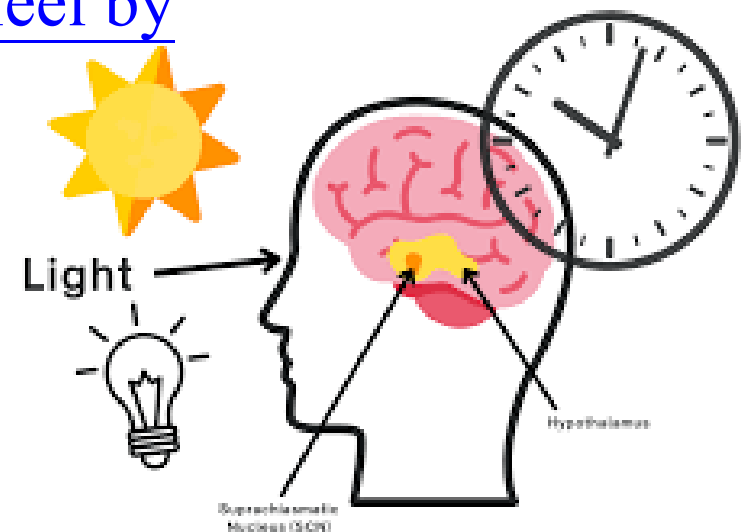
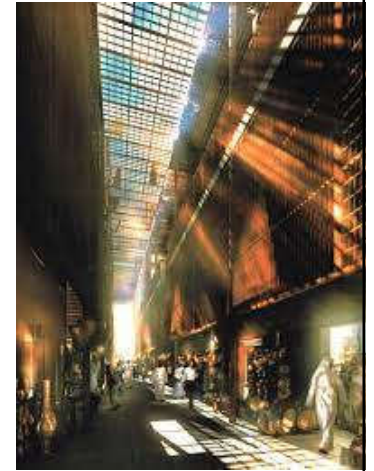

General lighting

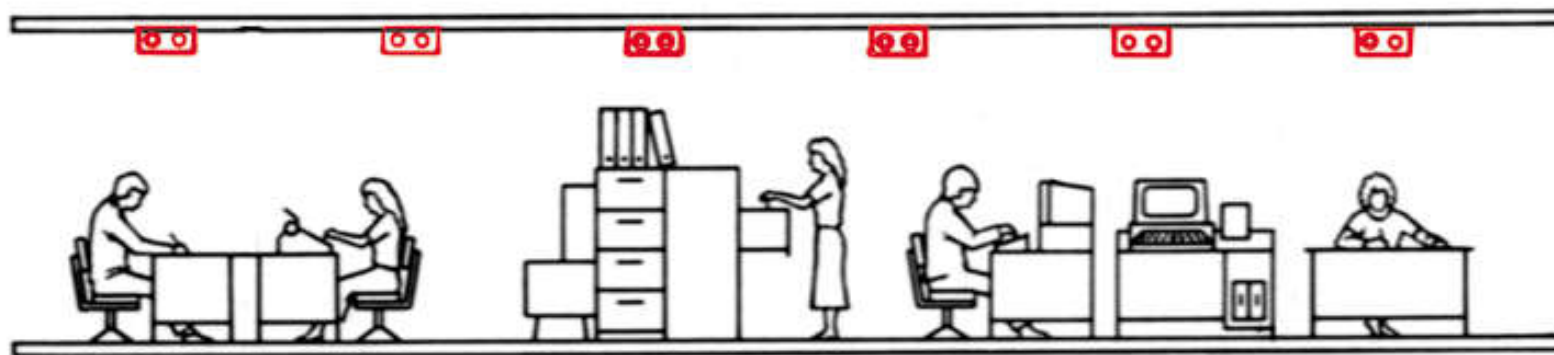

[Source: CIBSE Lighting Code]

Localised lighting



[Source: CIBSE Lighting Code]

Local (task) lighting



Basic principles



- Methods for creating the total (visual) environment:
 - 1. Ambient lighting
 - 2. Accent lighting
 - 3. Task lighting
 - 4. Perimeter lighting



Basic principles



- Ambient lighting

- Provides general, overall illumination
- Defines the space, and makes it a comfortable visual environment
- Two approaches:
 - Direct lighting (brightens objects & surfaces)
 - Indirect lighting (can give the feeling of spaciousness)

- Accent lighting

- Focuses on selected objects & surfaces, providing drama & excitement
 - Such as key light, fill light & silhouetting, sparkle & glitter

Basic principles



- Task lighting
 - Illuminates areas where work is performed, such as concentrated light from above
- Perimeter lighting
 - By lighting vertical surfaces to emphasize the architecture of the space & provide the necessary surround brightness
 - Two common approaches:
 - Wall Washing: appropriate for smooth surfaces; provide a uniform wash of light from floor to ceiling
 - Grazing: for non-uniform surfaces; emphasize the features of rough surfaces, e.g. wood-grain finishes, stone, brick & other textured surfaces

Volume (Ambient+Perimeter), Feature (Accent) and Task Lighting



(Source: St Matthews Church Light Design Concept, by Hoare Lea Lighting)

Major aspects & issues of lighting design

Light for Architecture	Light for Activity	Light for Atmosphere
<ul style="list-style-type: none">• Illuminate vertical surfaces to improve spatial perception• Separate functional areas• Emphasise architectural elements with accent lighting• Observe materials, texture & modelling• Mounting location & method, luminaire shape & arrangement• Visual comfort & light pollution	<ul style="list-style-type: none">• Adjust the brightness level to the visual task & adjacent areas• Avoid glare• Consider the time of day & natural light• Facilitate facial recognition & support person-to-person communication• Consider the room functions & zoning	<ul style="list-style-type: none">• Provide spatial orientation by highlighting entrances, routes & vertical surfaces• Create temporal orientation to give a sense of time• Create perceptual hierarchies by emphasising important areas with focal points• Allow individual adjustment• Consider visual comfort (glare & colour)

* Animation to demonstrate how the different aspects can change our perception of space & the atmosphere: <https://www.erco.com/en/service/human-centric-lighting-7320/>

Basic principles



- Planning process for lighting
 - Project analysis (quantitative & qualitative)
 - Utilisation of space
 - Psychological requirements
 - Architecture & ambience
 - Lighting concept (consult with other trades)
 - Design (design decisions, calculations)
 - Installation (luminaire types & mounting)
 - Maintenance (e.g. cleaning, replacement)



Lighting design & planning

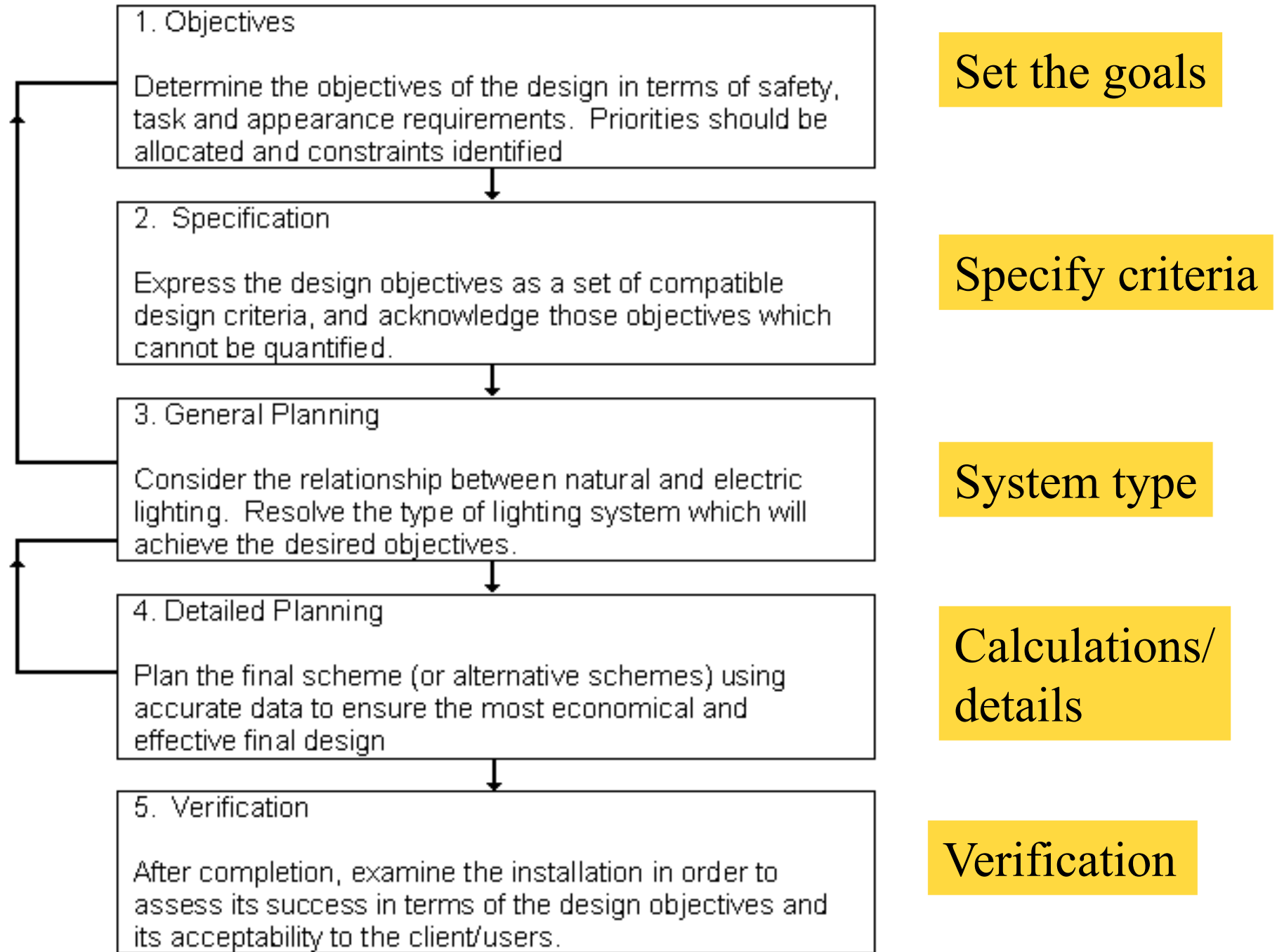

Basic principles



- Types of lighting (indoor)
 - General lighting
 - Accentuation
 - Washlighting
 - Wallwashing
 - Projection
 - Orientation lighting



Design process



- Video: Lighting Design Process (4:12)

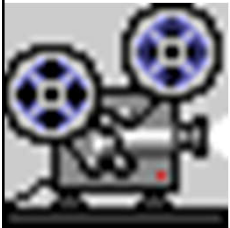

- <https://youtu.be/hpyq6uktBwM>

- Typical building design process (7 steps):

- Programming
- Schematic design
- Design development
- Construction documents
- Bidding (tendering)
- Construction & handover
- Post-occupancy evaluation (POE)

Design process



- Basic approach to lighting design
 - Determine lighting design criteria
 - Quantity of illumination (lighting level, lux)
 - Quality of illumination (e.g. overall appearance, colour)
 - Codes and regulations (e.g. building, electrical, energy)
 - Record architectural conditions & constraints, e.g.
 - Window location & size, ceiling height, finish materials
 - Determine visual functions & tasks to be served
 - Select lighting system to be used

Design process



- Basic approach to lighting design (cont'd)
 - Select luminaire & lamp types
 - To produce the desired light & fit the client's needs
 - Determine number & location of luminaires
 - Through calculations & assessment
 - Place switching & other control devices
 - User convenience & energy management
 - Aesthetic & other intangibles
 - Aesthetic, psychological, cultural & contextual factors

Design process



- The process of designing with light focuses on:
 - What to light
 - How to light it
 - What to light it with



Design process



- Questions to ask at the planning stage:
 - What activities will the space be used for?
 - What tasks are to be accomplished in the space?
 - What are the object(s) you most want to see?
 - Which architectural features are to be emphasized?
 - Where is the seating area?
 - What is the desired mood (ambience)? Does it need to be varied?
 - What style must the lighting coordinate with?

Design process



- What to light
 - Setting priorities
 - Give the space a focus
 - Consider the space as a whole
 - Analyse the space
- How best to light it
 - Using ambient, accent & task lighting
- How much light
 - Depends on these factors: age, speed, accuracy & the reflectance of the task
 - Also consider architectural & energy/environment



Design process



- Where to place the light
 - To avoid glare & veiling reflections
 - To emphasize or minimise surface texture
- What to light with
 - The lamp, the luminaire & the controls
 - Choosing the lamp
 - Light distribution
 - Electric energy consumed
 - Colour rendering & colour appearance
 - Maintenance costs



Design process



- Obtaining the desired distribution
 - Depends on the lamp & luminaire, and purpose
 - The required light distribution may range from broad & widely diffused to narrow & focused
- Choosing the luminaire
 - Intended light distribution, function or purpose
 - Appearance or style
 - Mounting: recessed, surface, pendant, wall
 - Type of building construction: new, existing, insulated
 - Product quality: detailing, finish, durability
 - Operating cost: energy, relamping, cleaning
 - Initial cost

Types of lighting fixtures for retail stores

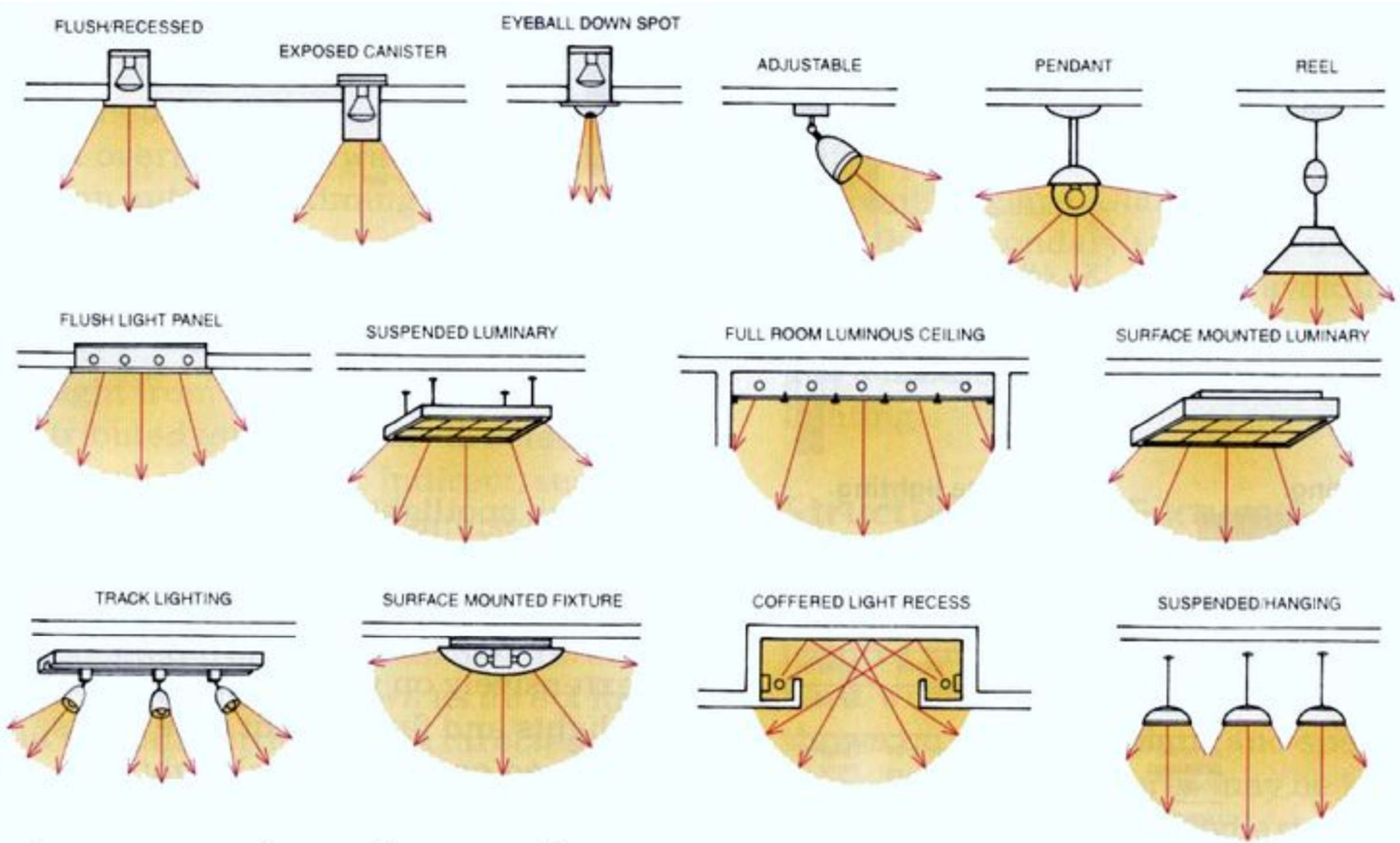

Different mounting methods for fully direct, fully indirect & a combination of direct-indirect general lighting systems

Direct lighting

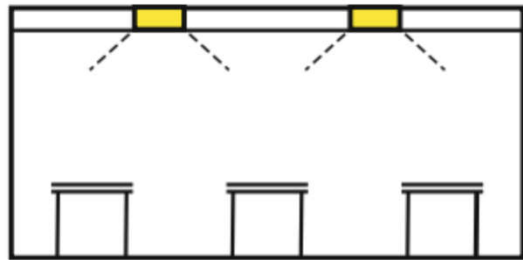

ceiling-recessed

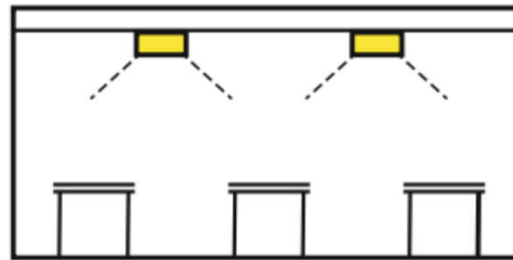

ceiling-mounted

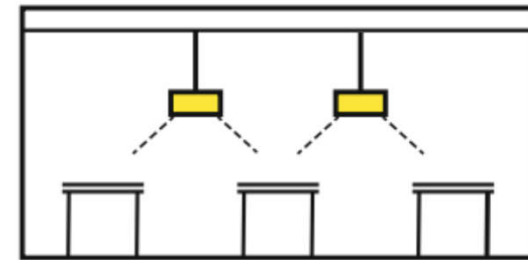

suspended

Indirect lighting

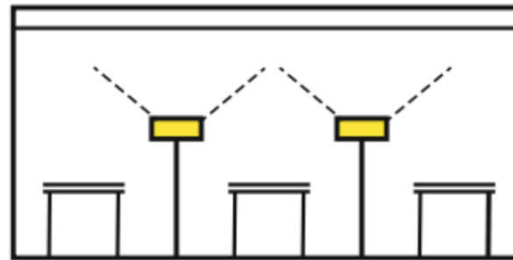

free-standing

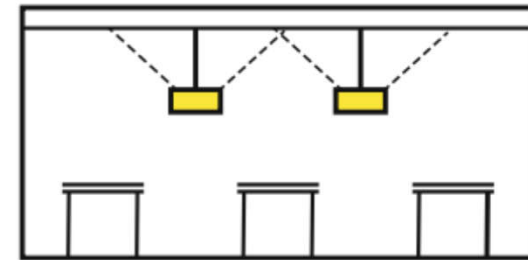

suspended

Direct / indirect lighting

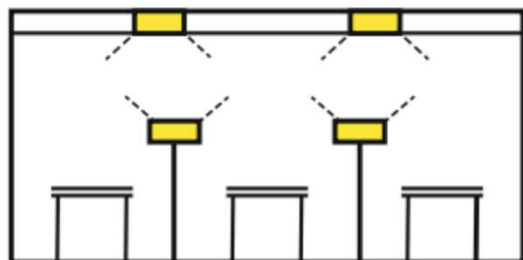

*ceiling-recessed (or mounted)
plus free-standing*

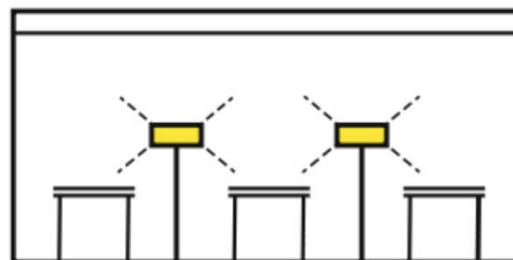

free-standing

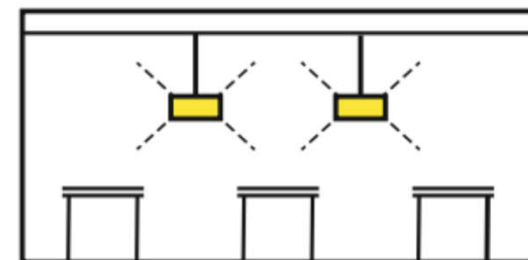

suspended

Design process



- Choose the lighting controls when you want to:
 - Change the lighting scene to suit the activity
 - Set a mood
 - Create an atmosphere
 - Extend incandescent lamp life
 - Control the lights from several locations
 - Save energy by turning off the lights automatically when no one is present



Design process



- Typical lighting control strategies:
 - User controlled lighting
 - Scheduling
 - Daylight harvesting
 - Task tuning
 - Adaptive compensation
 - Lumen maintenance
 - Occupancy sensing



Design process



- Lighting control equipment:
 - Switches
 - Occupancy sensing
 - Scheduling (timeclocks)
 - Daylight dimming
 - Tuning
 - Preset dimming
 - Building management

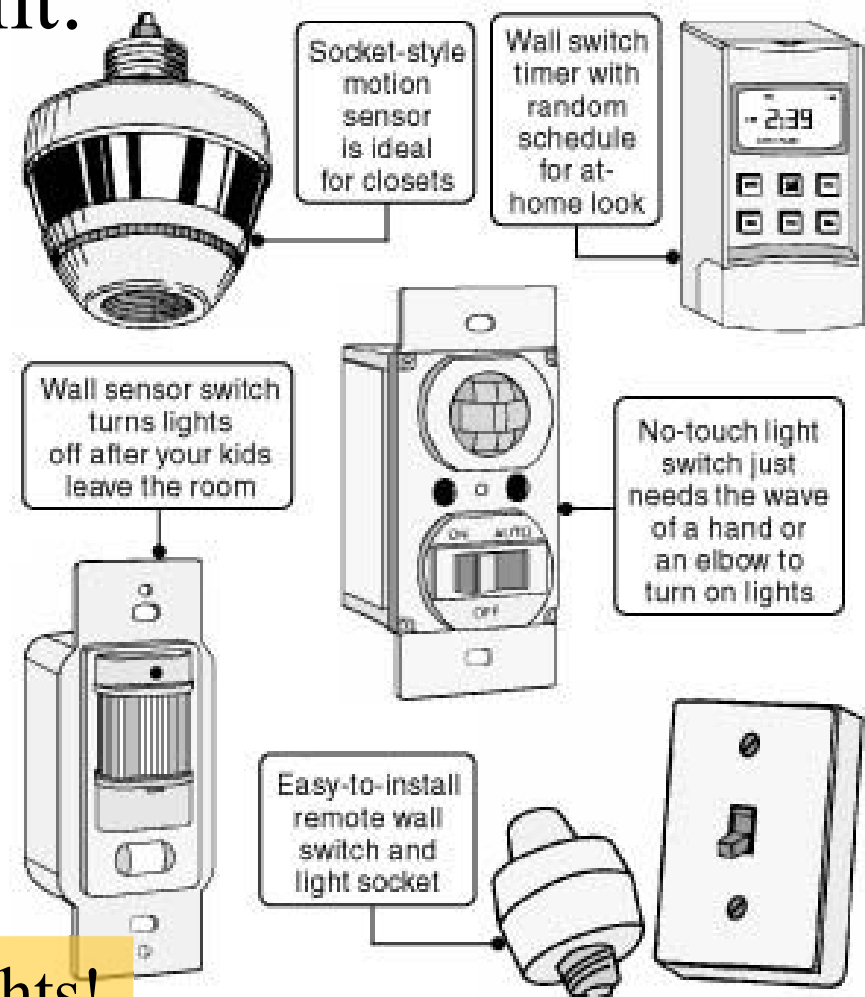

Remember: switch off unnecessary lights!

Design issues of lighting system control

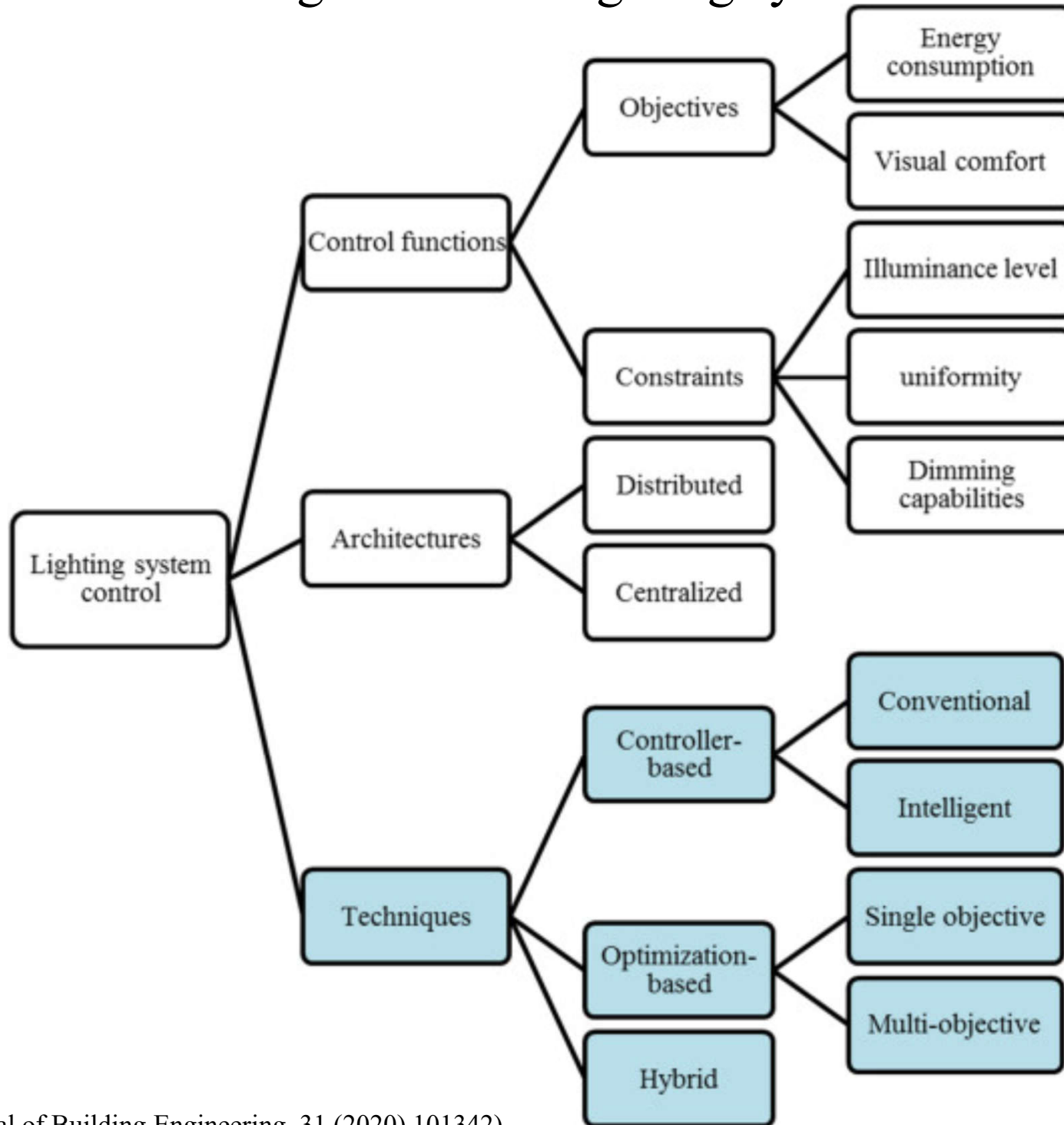

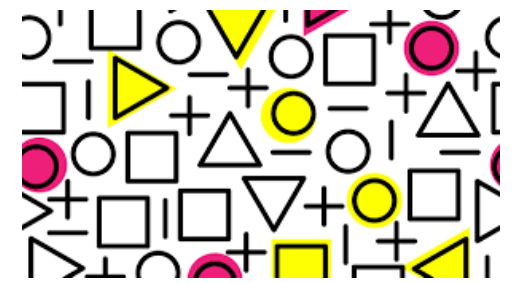

Design factors & issues

- Factors affecting visual performance:
 - Inadequate illuminance
 - Too great or too low a contrast
 - Disability & discomfort glare
 - Veiling reflection
 - Flicker from fluorescent lamps
 - Psychological factor (occupant's satisfaction with the environment)



Lighting quality aspects & parameters for indoor lighting installations

Visual aspects	Non-visual biological aspects
Lighting level <ul style="list-style-type: none">• On the tasks• On the room surfaces	Lighting level <ul style="list-style-type: none">• On the eye• Time dependent• Melanopic irradiance
Lighting uniformity & direction <ul style="list-style-type: none">• Face recognition & modelling (e.g. cylindrical illuminance)	Spectrum <ul style="list-style-type: none">• Time dependent• Chromaticity
Glare restriction <ul style="list-style-type: none">• Unified glare rating (UGR)	Timing <ul style="list-style-type: none">• Circadian stimulus
Colour appearance & rendering <ul style="list-style-type: none">• Correlated colour temperature• Colour rendering index	Duration

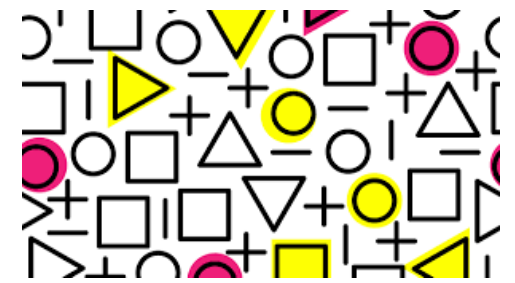

Design factors & issues

- Important to consider:
 - Situation – is it a working, viewing, circulation or a living space?
 - Function – what will people do in the space?
 - Quantity and Quality of Light – what's needed to perform the tasks?
 - Architecture and Décor – consider the aesthetic of the space
 - “Atmosphere” – what is the mood or ambience of the space?

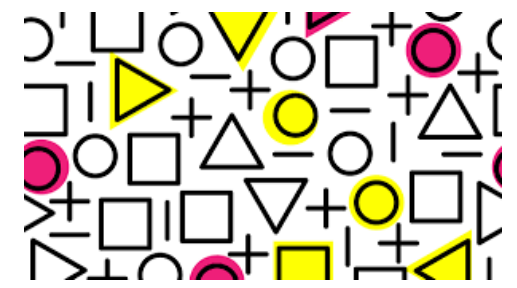

Design factors & issues

- Lighting & behaviour
 - Lighting is used to modify behaviour
 - To attract attention
 - Such as using spotlights, flashing lights or accent lights
 - Display lighting: attract attention w/o causing discomfort
 - To direct movement or traffic
 - Such as in museums or shopping centres
 - To facilitate communication
 - Such as to facilitate speech intelligibility (can see the face of the speaker or do lip-reading)

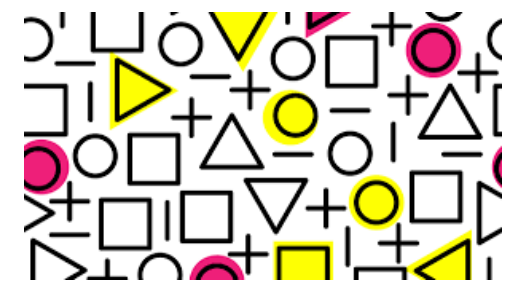

Design factors & issues

- Light as **a material**
 - What we see is made visible by reflected light
 - Properties of light source & surface materials
 - Brightness, appearance, ambience, colour scheme
- Light as a medium for **visual communication**
 - Perception of environment, atmosphere of a space
 - Client's & users' expectations
 - The light responds, enhances & emphasizes
(architecture & light interact)

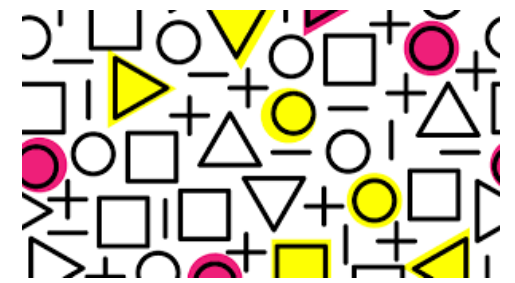

Design factors & issues

- Lighting quality & criteria
 - Lighting level (illuminance or luminance)
 - Horizontal, wall & ceiling
 - Luminance distribution
 - Better distribution of brightness within the field of view
 - Freedom from disturbing glare
 - Spatial distribution of light
 - General lighting, directional lighting, backlighting & uplighting, diffuse lighting
 - Light colour & colour rendering
 - Colour temperature & colour rendering index

Recommended room reflectances (ρ) & luminance distribution

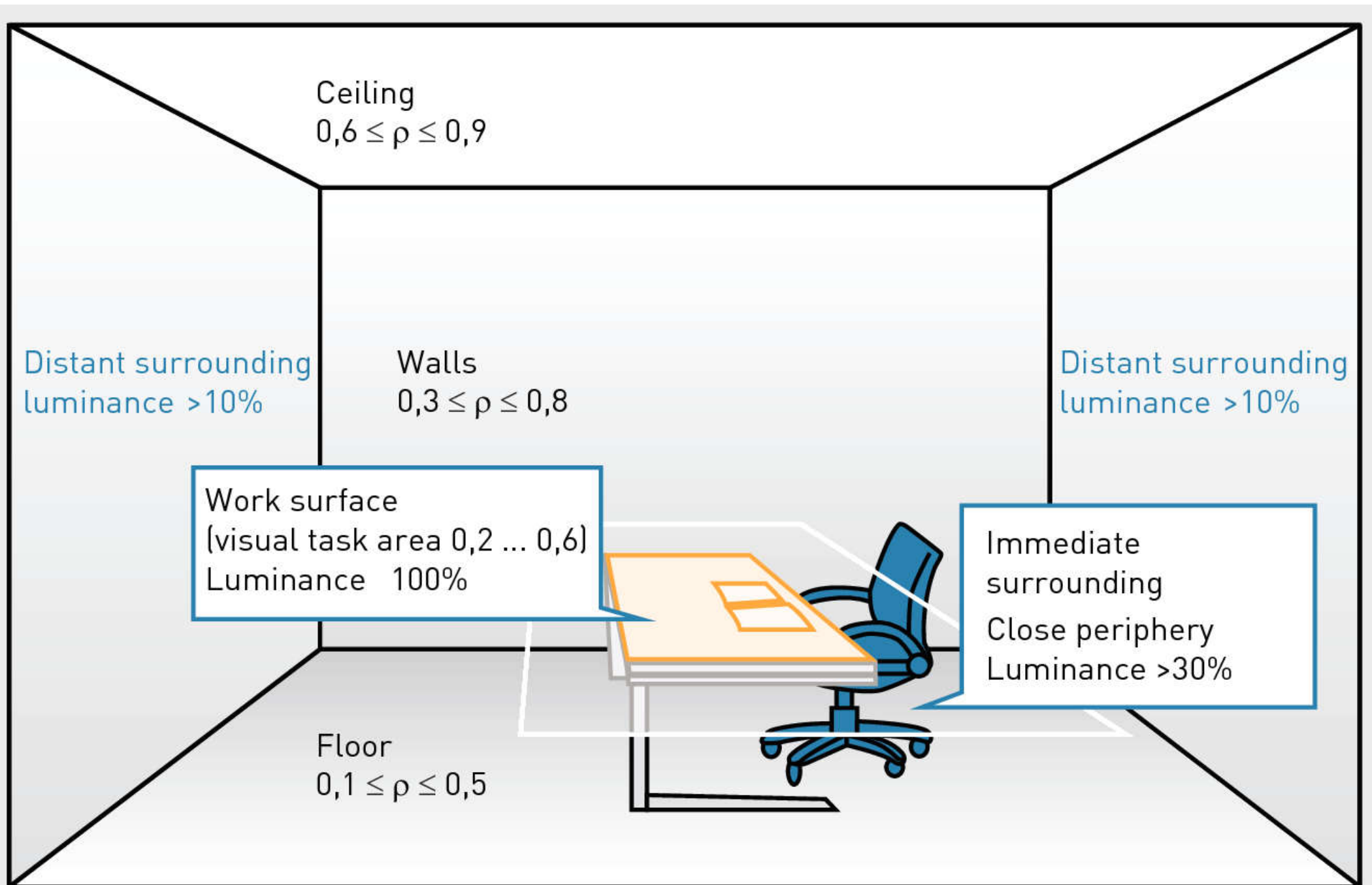

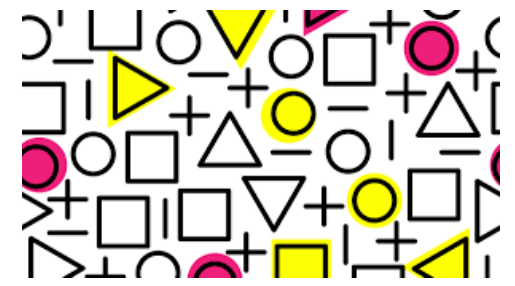

Design factors & issues

- Typical lighting design issues
 - Planes of brightness (high brightness creates cheerful atmosphere)
 - Glitter & sparkle (stimulating points)
 - Light & shadow (create focal points)
 - Modelling (reveal dimensionality)



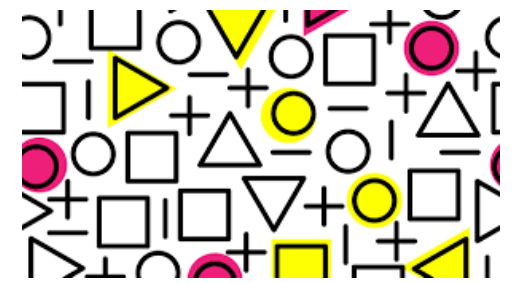

Design factors & issues

- Directional effects (form, dimension & texture)
 - Direction & distribution of light within a space
 - Influence perception of the space
 - Relates partly to desirable illumination levels & partly to architectural style & visual emphasis
 - Good light design - an appreciation of the nature & qualities of the surfaces
 - Modelling – ability of light to reveal solid form
 - Fail to do that will result as bland & monotonous
 - Emphasis – e.g. surface texture & characteristics

Perception of three dimensional forms & surface structures under different lighting conditions

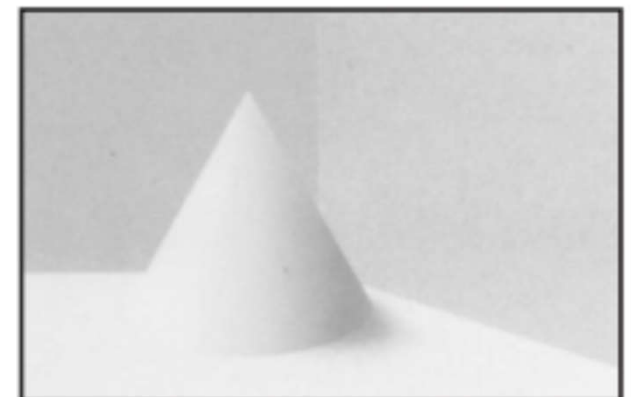
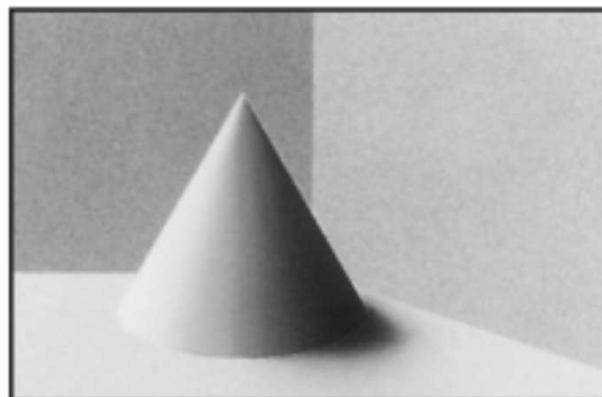
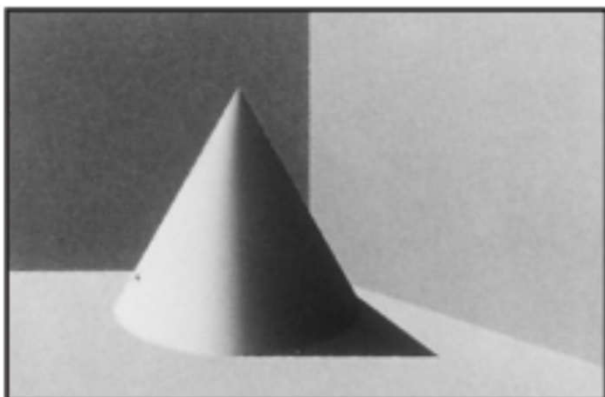
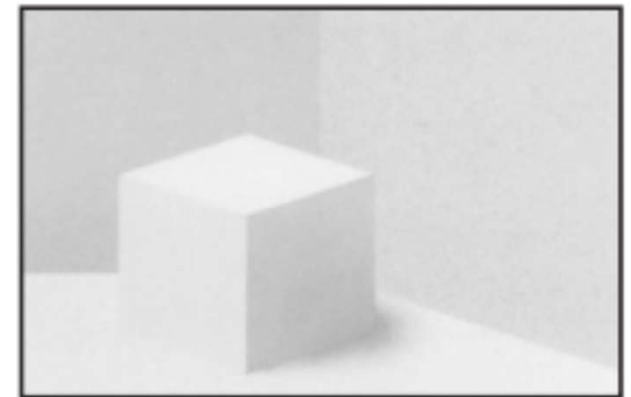
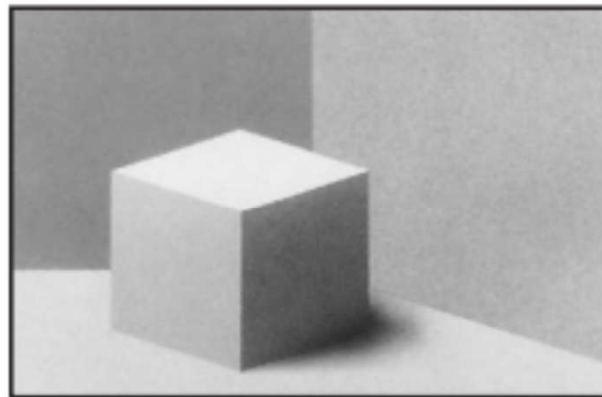
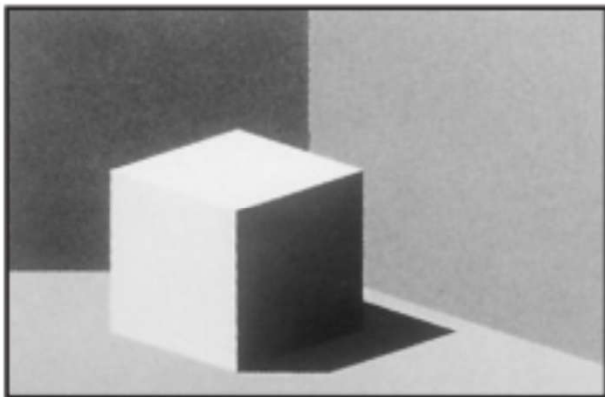
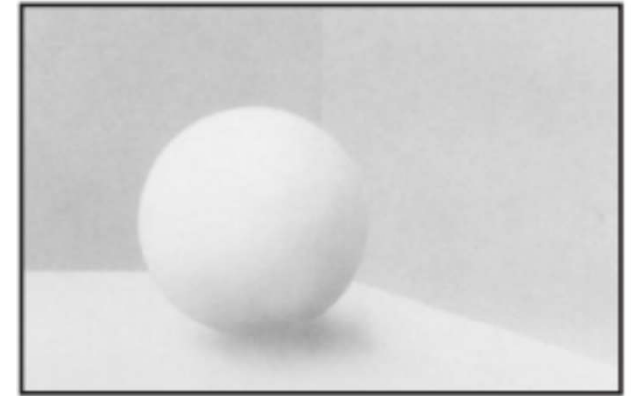
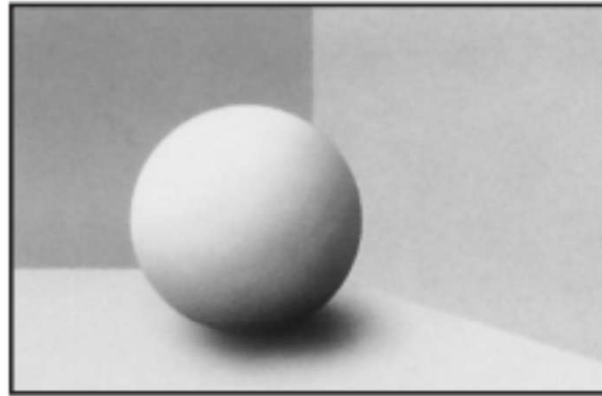
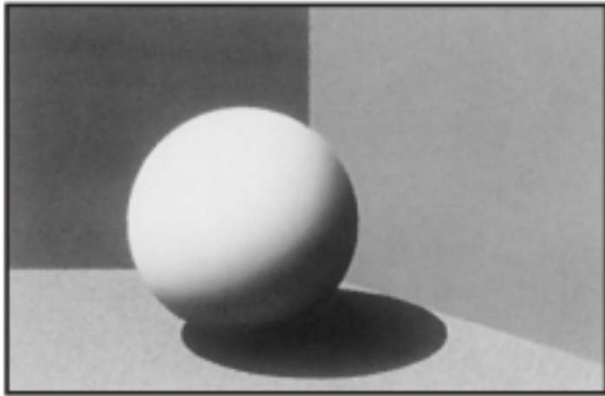

Examples of directional effects in lighting design

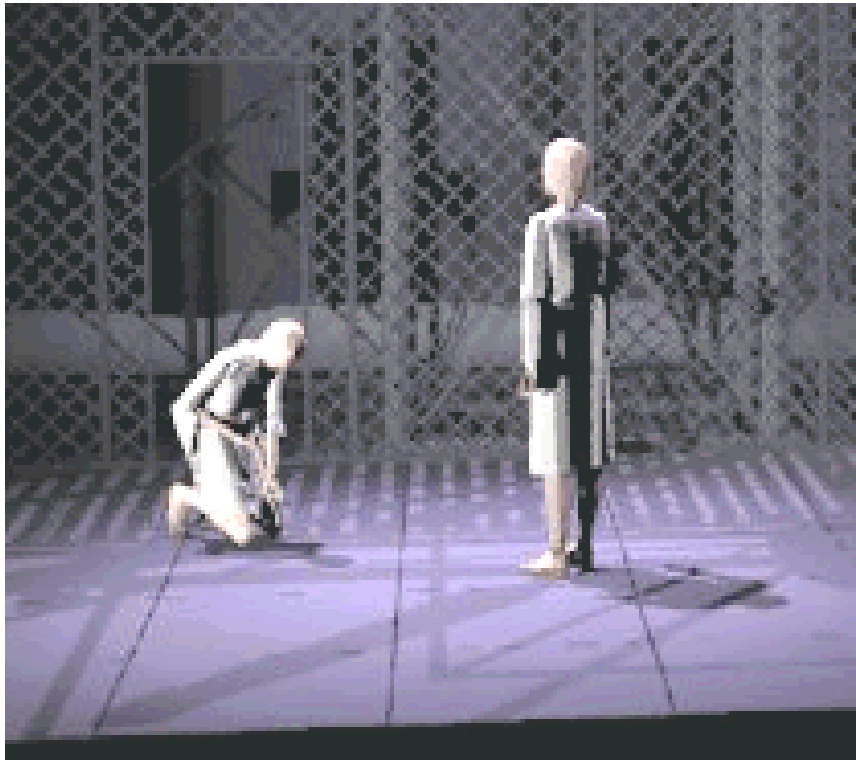

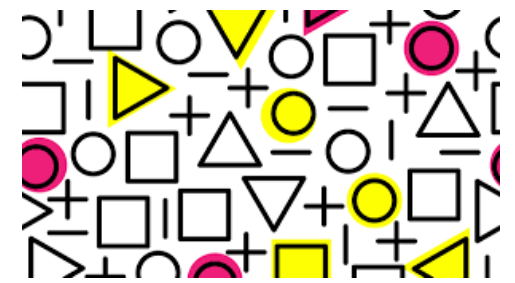

Design factors & issues

- Techniques to achieve specific lighting effects
 - Downlighting (w/ downlights & recessed troffers)
 - Wall washing/grazing (uniform, shadow/texture)
 - Cove lighting (illuminating perimeter coves)
 - Uplighting (table candlelight & highlighting)
 - Silhouetting (backlighting an object)
 - Sparkle/glitter (tiny points of glare for visual interest & produce a sense of elegance)

Different lighting effects in a private office



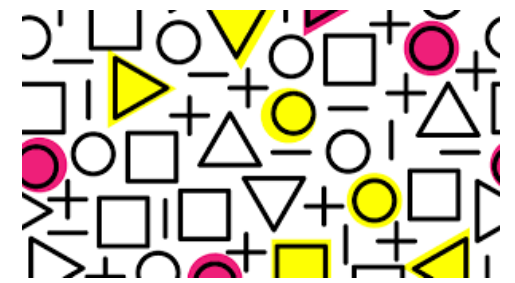

Design factors & issues

- Choice of appropriate colour of light source
 - Determined by the function of the room
 - Involve psychological aspects & practical factors
- Appearance of coloured surfaces
 - Controlled by spectral power of source
 - Power balance & presence or absence of certain wavelengths affect colour rendering

Blue light could be the best light for concentration, whereas lower & warmer light is the better option for promoting social interaction (group work)

Glare control



- Glare 眩目光
 - Occurs when objects, seen directly or by reflection, are too bright c.f. the general background
 - Disability glare - impairs ability to see detail w/o necessarily causing visual discomfort
 - Shift in adaptation level
 - Discomfort glare - causes visual discomfort w/o necessarily impairing vision
 - Depends on occupant's activity, angle of view, size & brightness of source, average luminance of background



(Video: What is glare? (2:13) <http://www.youtube.com/watch?v=PwHXut8lw4M>)

Light scatter in the eye due to glare

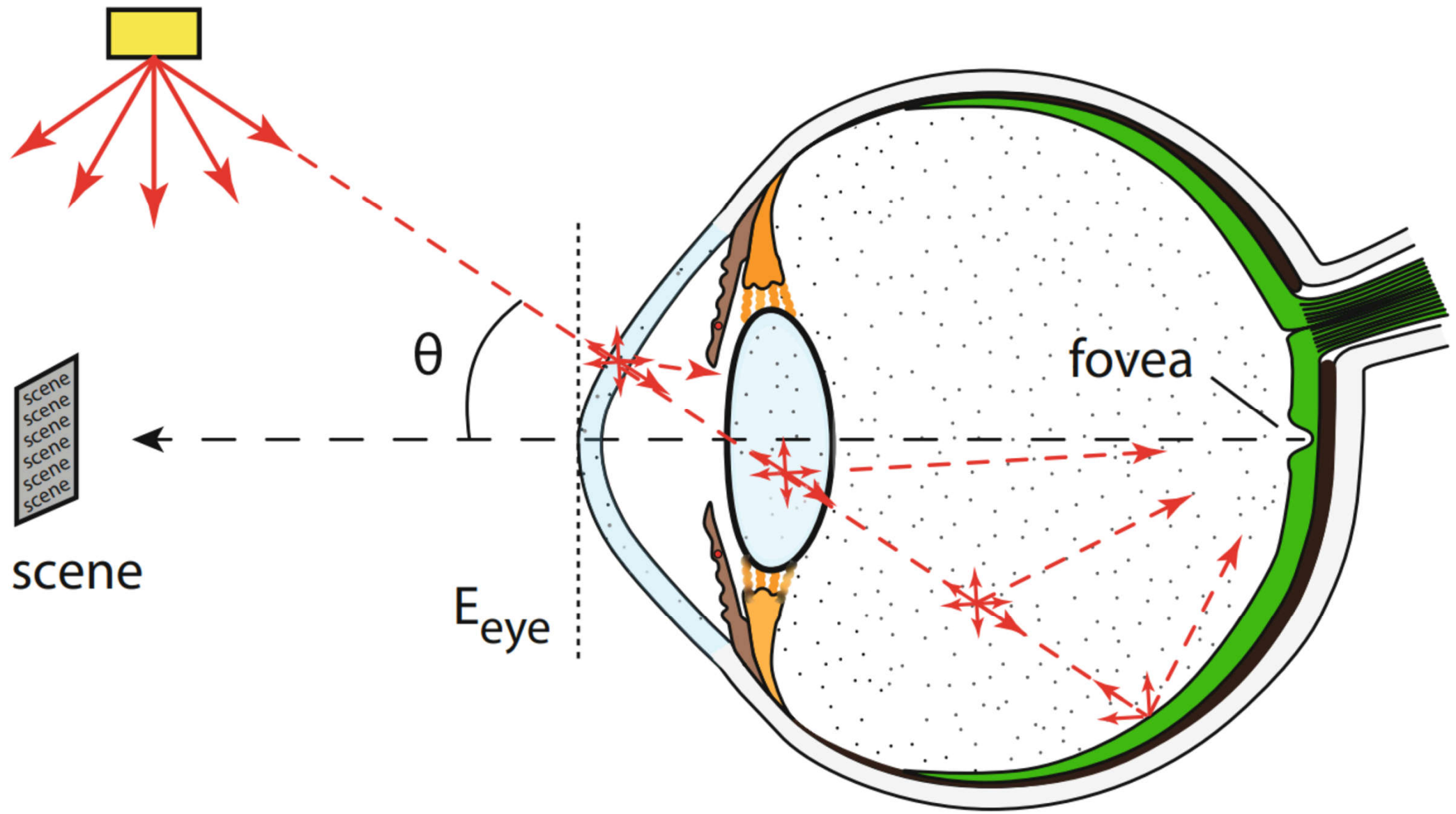



Disability glare from bright sky in front of a VDT makes the screen difficult to read



Discomfort glare from bright luminaires

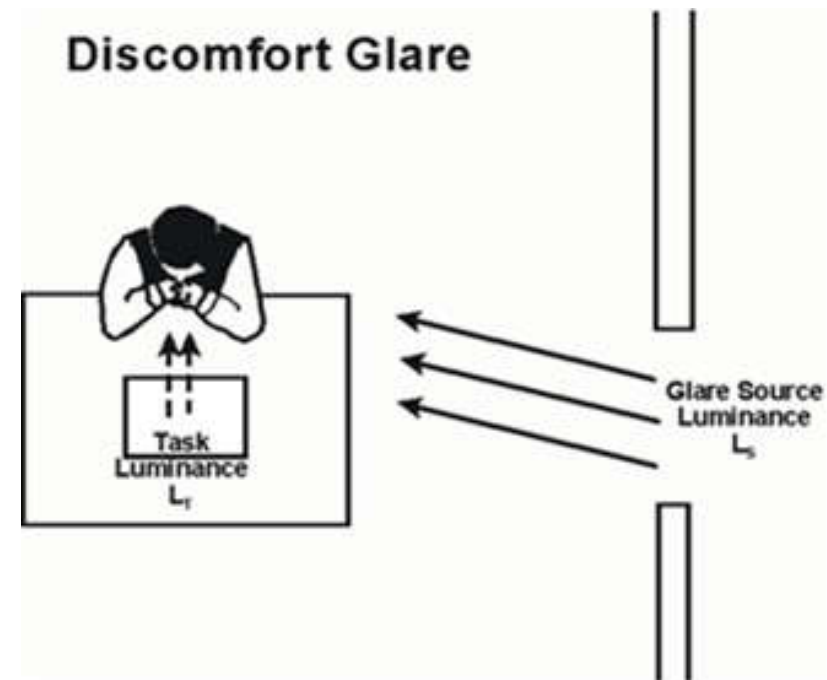
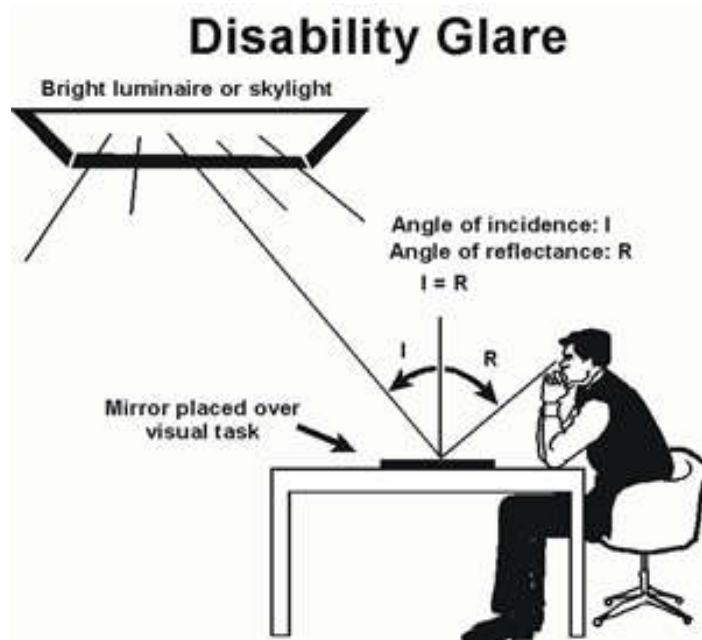

Glare control



- Reduce glare from artificial light sources (1/2)
 - Limit the luminance of sources in eye's direction
 - Replace a bright source with few weak sources
 - Restrict light distribution to ↓ sideways light to the eye
 - Screen the sources from view
 - Introduce downstand screens
 - Use screening within the fitting (e.g. louvres)
 - Enclose source in light diffusing panel/fitting
 - Conceal fittings from view (e.g. by beams)
 - Shielding against glare (e.g. shielding angle)

Task, immediate surrounding & background areas

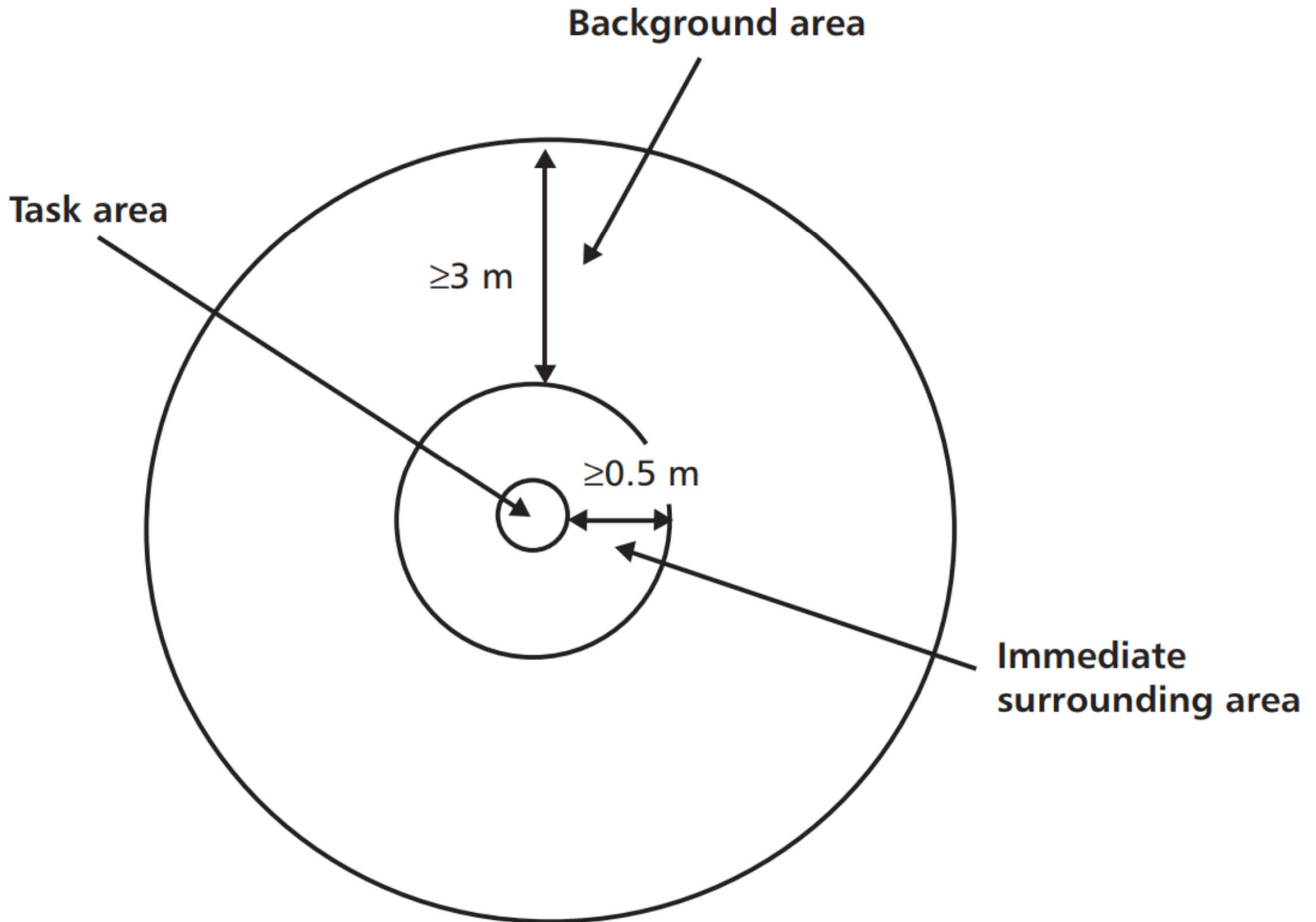

Glare control



- Reduce glare from artificial light sources (2/2)
 - Re-position the work station to avoid glare
 - Raise background luminance
 - Use fittings with more upward flux (brighten ceiling)
 - Specify higher reflectance floor
 - Use light-coloured finishes

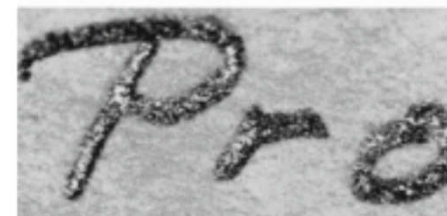
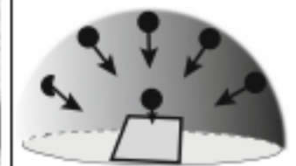
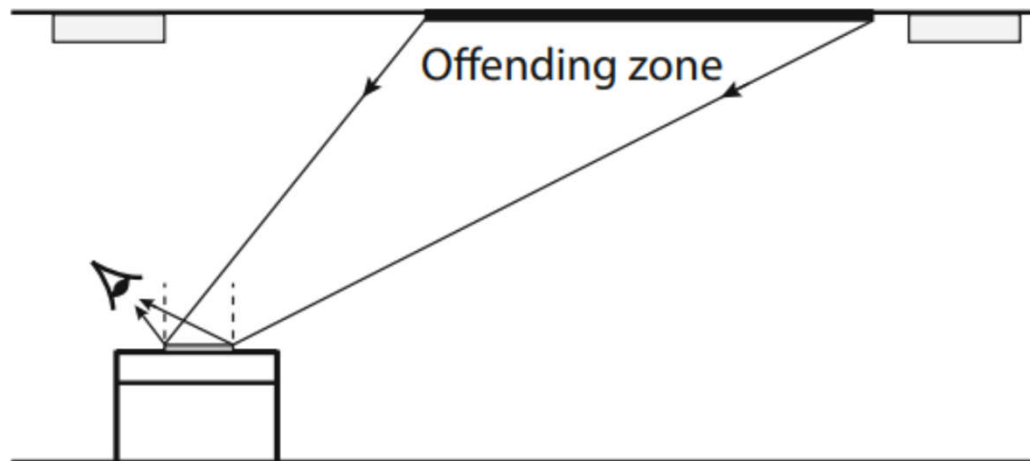

Glare control



- Reflected glare & veiling reflection
 - Bright patches on glossy surfaces from reflection
 - *Reflected glare* - produce visual discomfort
 - *Veiling reflection* - reduce contrast & visibility
 - May be minimised by:
 - Ensure no part of the task is at or near the mirror angle with respect to the eye & bright source
 - Increase light falling sideways onto the visual task
 - Use luminaires w/ large surface area & low luminance
 - Use paper, machines, materials etc. with matt surfaces

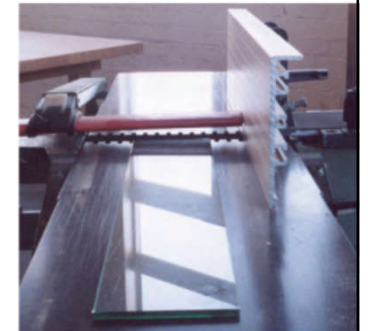

Glare control for display screen equipment (DSE)

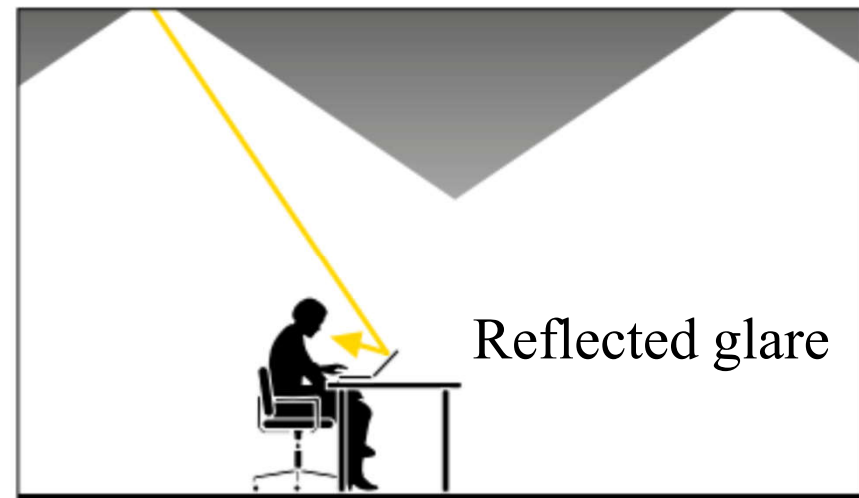
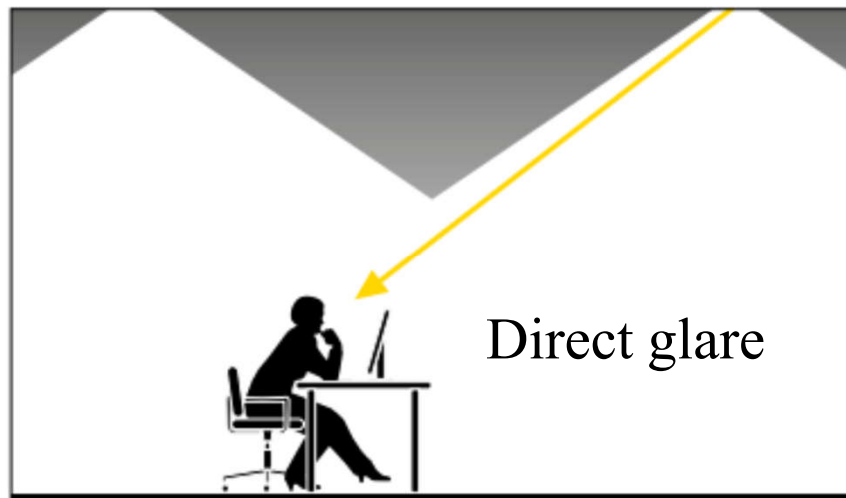
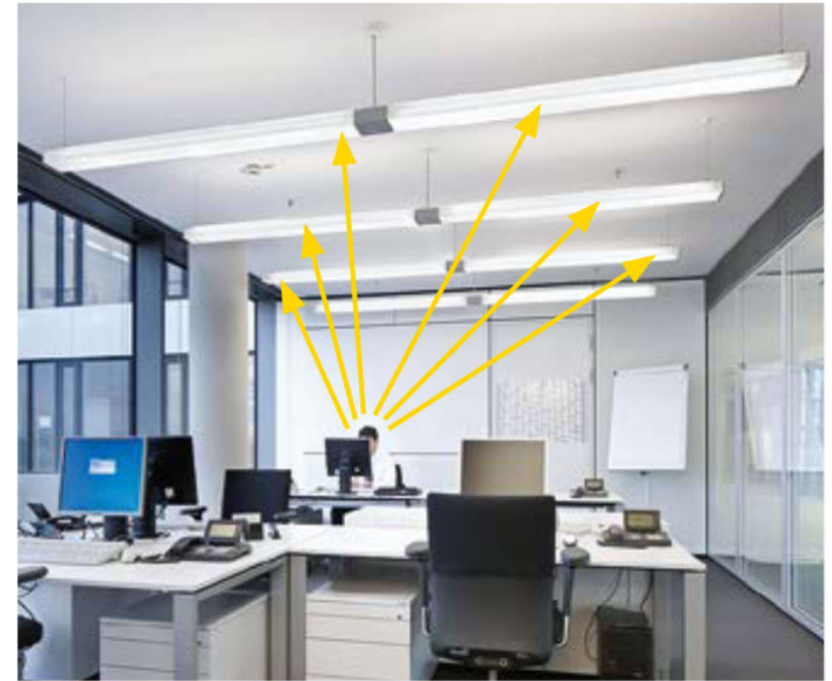
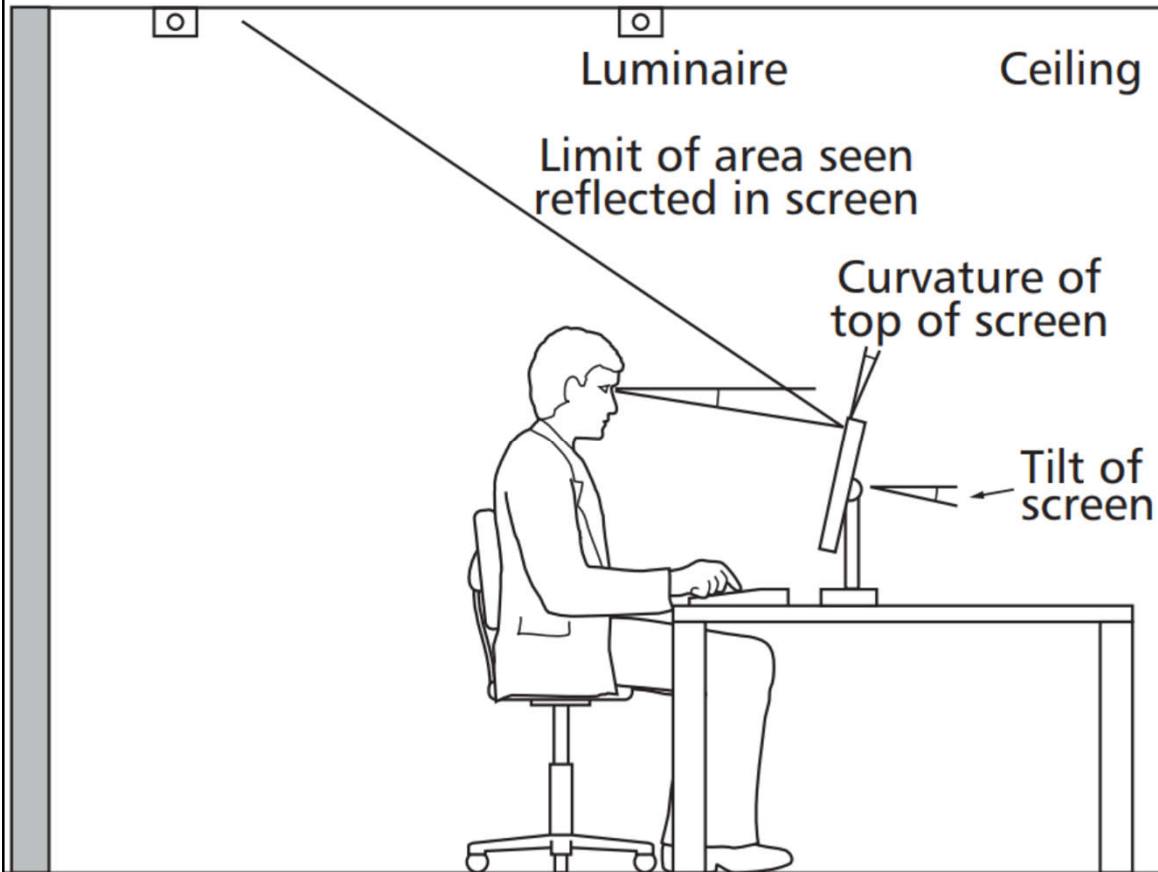

Example of how to apply glare limitation to an illuminance level of 500 lux. From the geometry of the space the viewing angle for the first luminaire is 55° , for the second luminaire 70° . The corresponding luminances can be read off luminance curve 1 in the diagram.

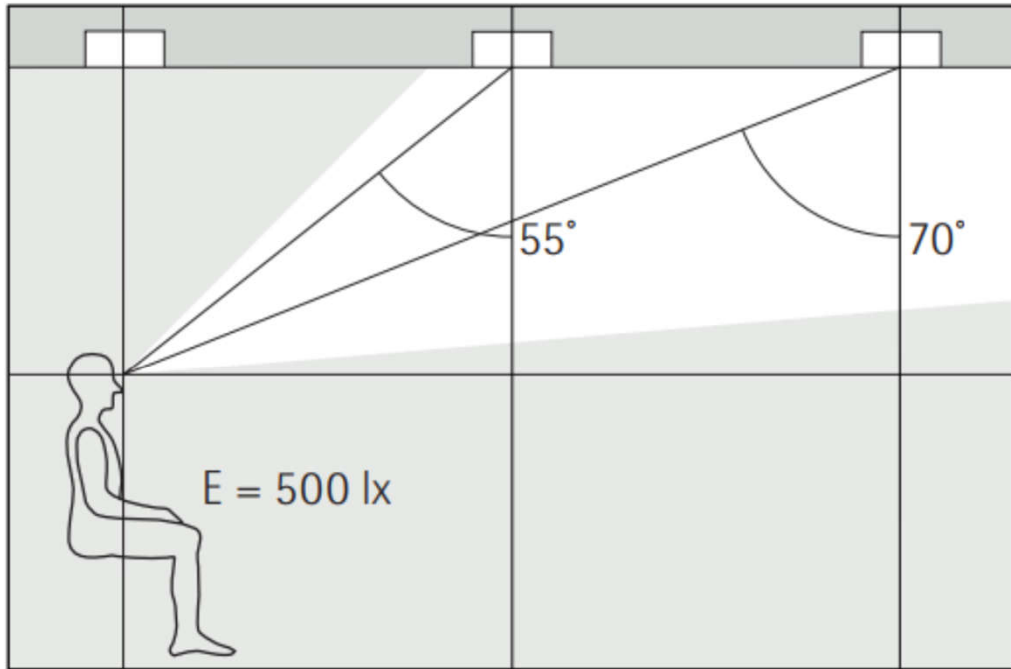

Category	Mean illuminance (lx)				
A	1000	750	500	-	300
1	2000	1500	1000	750	500

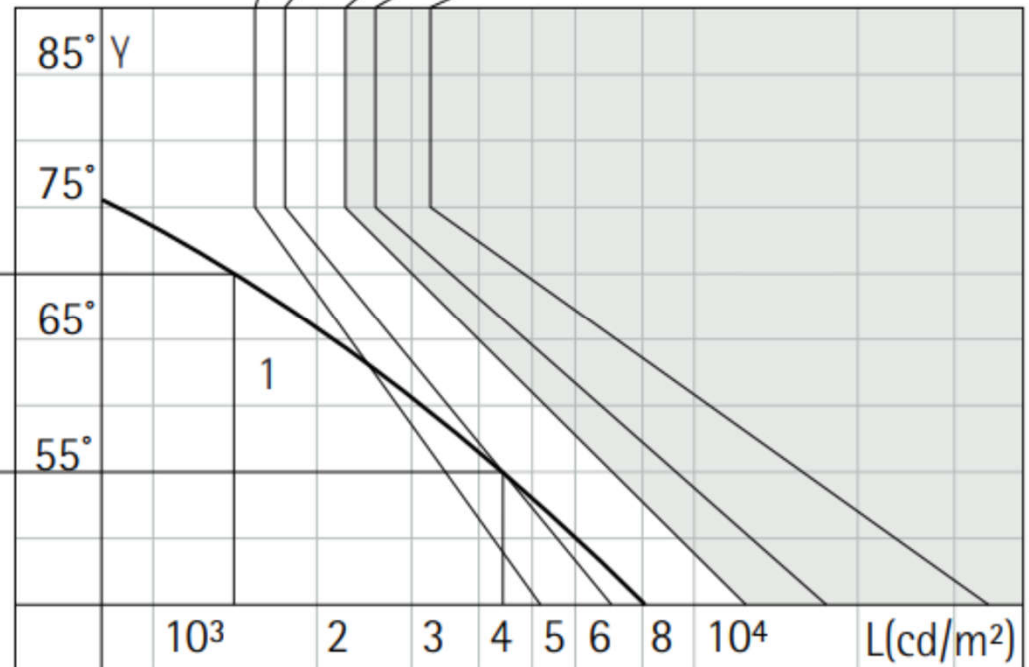

Arranging linear luminaires parallel to the viewing direction & windows limits disturbing glare from the windows & restricts the area of the working plane where disturbing reflections from luminaires may occur

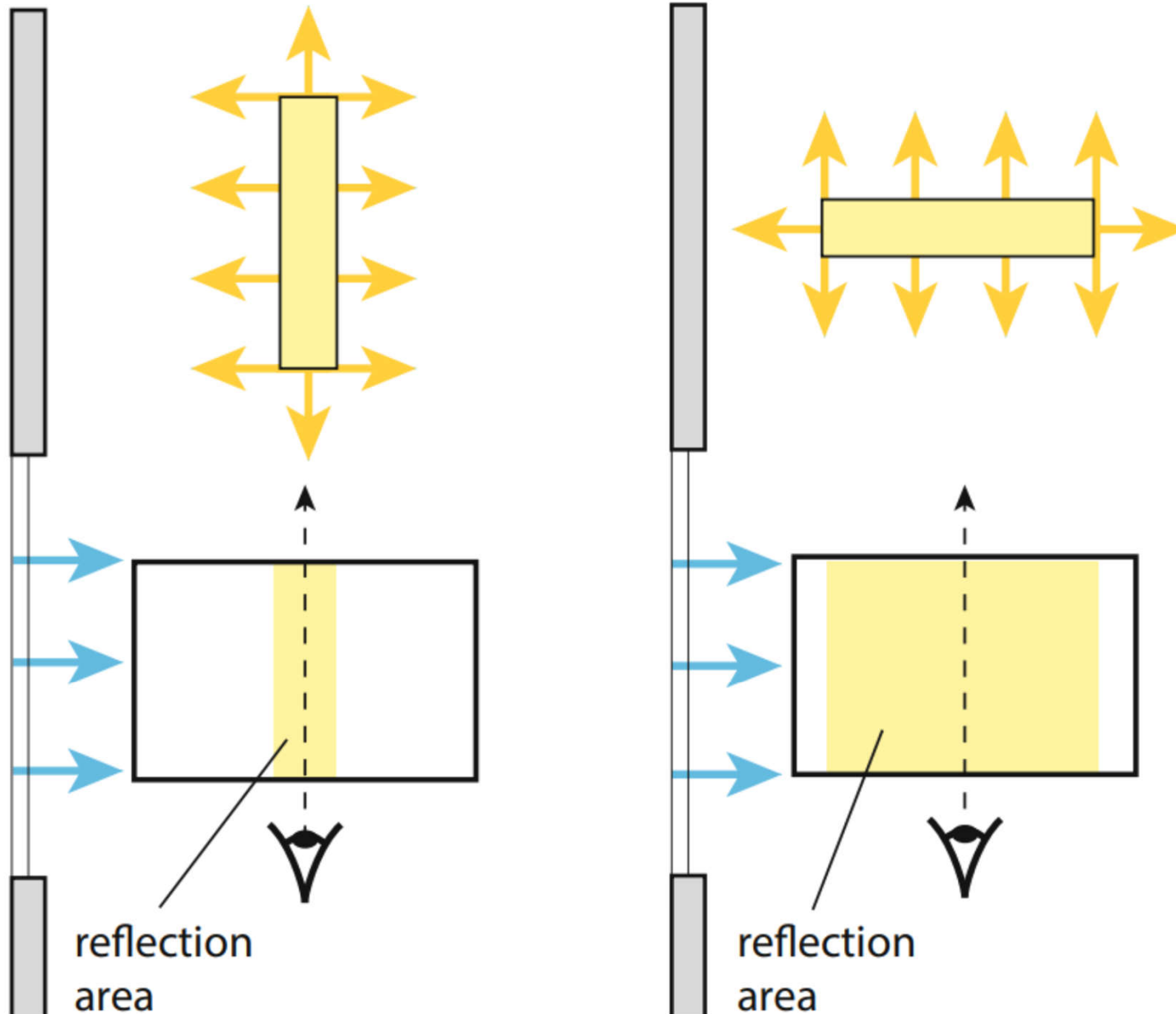

Room & luminaire layout for glare index calculation

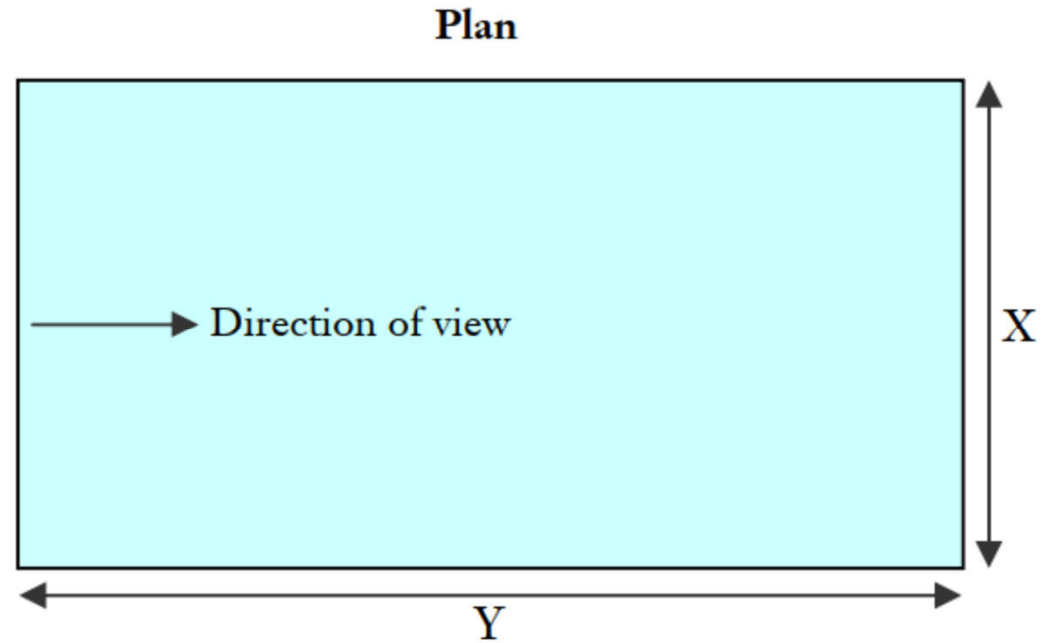
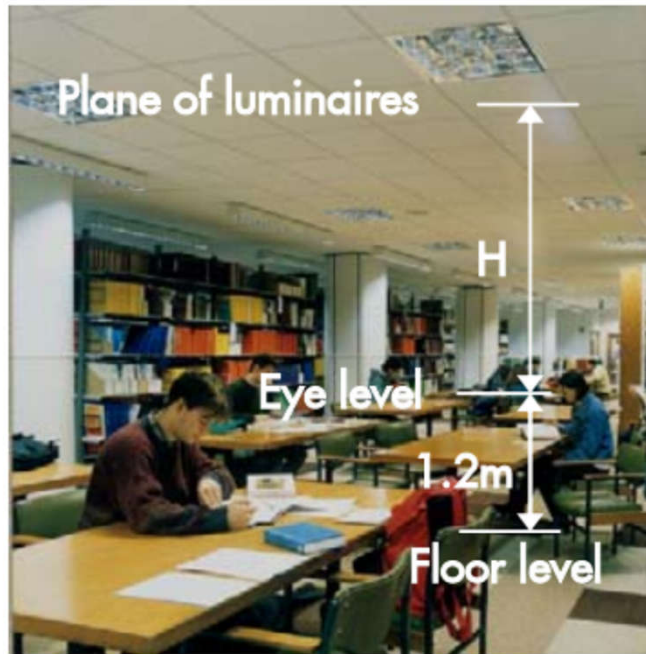

Long view
4H

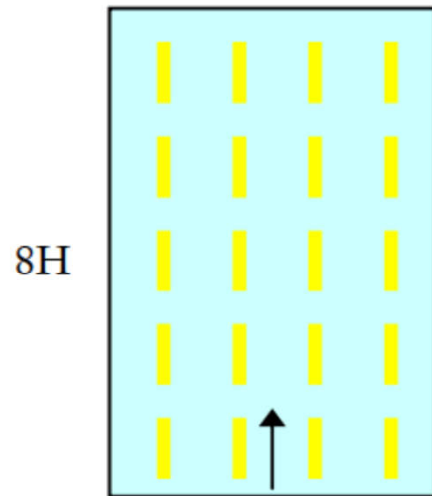

Short view
4H

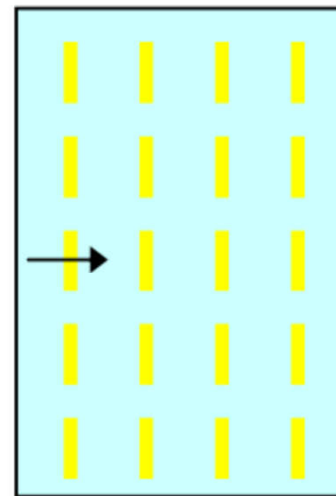

Long view
4H

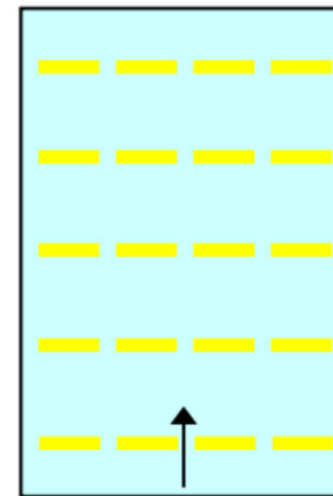

Short view
4H

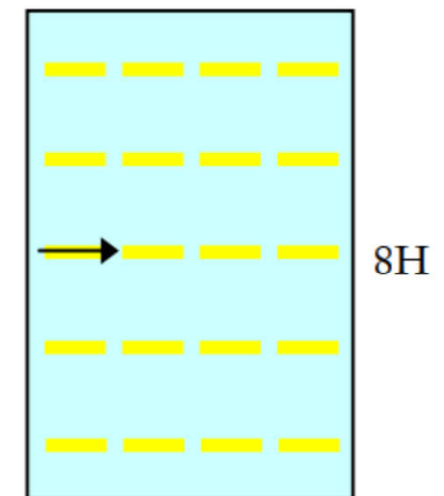

Elevation angles for wall mounted luminaires in hospitals

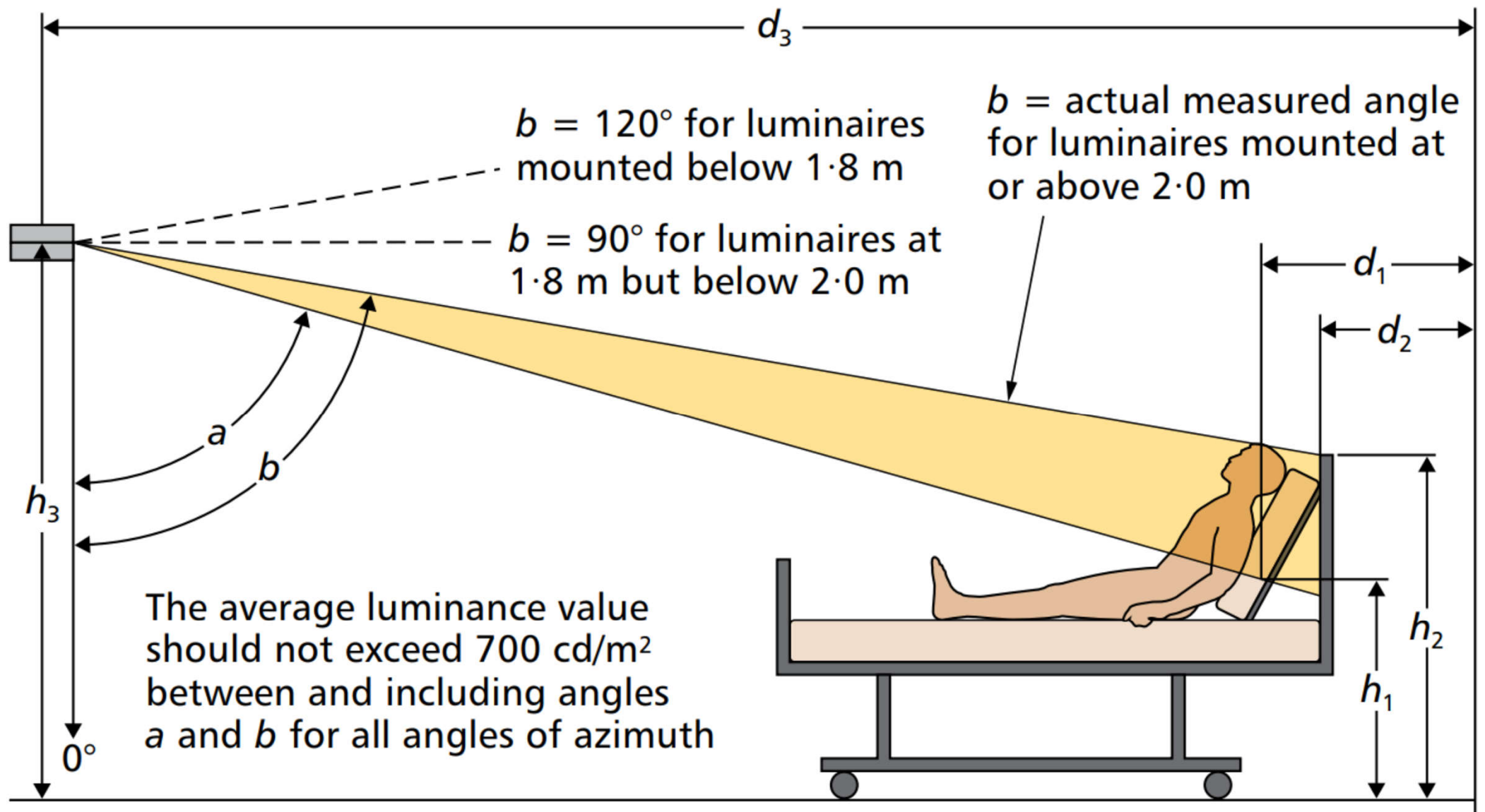

Whiteboard luminaires in classrooms need to be carefully positioned

Whiteboard luminaire must be installed within the shaded area to avoid reflections in the board to the nearest viewer

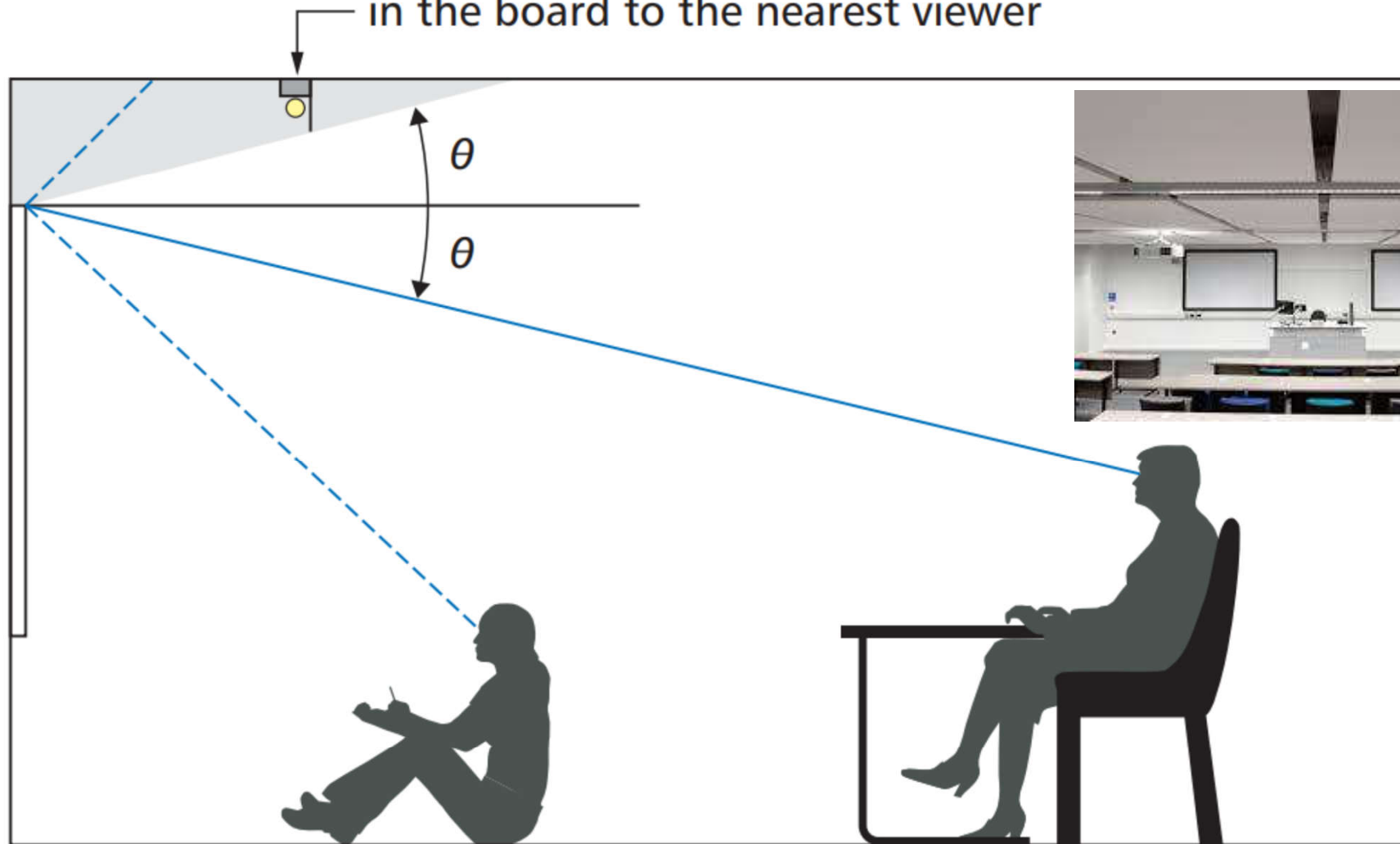

Where students may sit close to an interactive whiteboard the board light may need to be switched off to reduce glare



Further Reading

- Design examples Indoor
<https://www.ereco.com/en/designing-with-light/lighting-knowledge/design-examples-indoor/>
- Interior Lighting Design
http://ibse.hk/IBTM5680/Interior_Lighting_Design.pdf
- Illustration videos:
 - Lighting Applications: Office (3:16) <https://youtu.be/ZUYNothLj9c>
 - Lighting Applications: Fashion (1:59) <https://youtu.be/wrMcggqw1FE>