

Sewage Disposal

Ir Dr. Sam C. M. Hui

E-mail: sam.cmhui@gmail.com

<http://ibse.hk/cmhui/>

Contents



- Drainage below ground
- Testing & sewage pumping
- Methods of sewage disposal
- Sewage treatment process

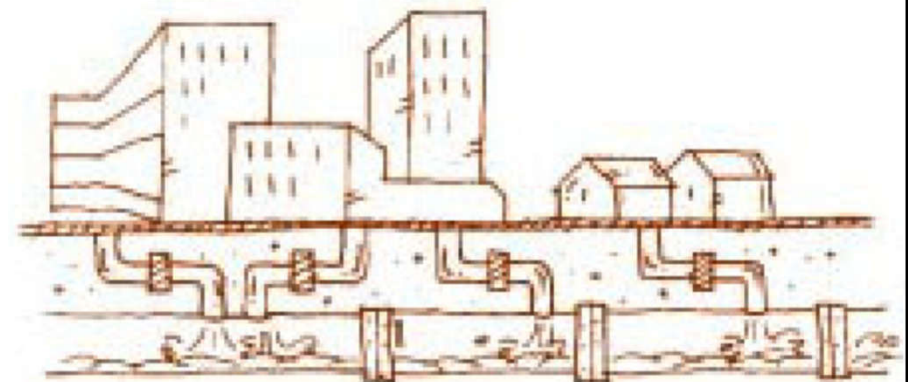



Drainage below ground

- Sewage (= domestic/municipal wastewater)
 - Pollute the environment & harm human health
 - Should be 'treated' before discharged
- Sewage 汚水 (wastewater) consists of:
 - Greywater (from sinks, bathtubs, showers, dishwashers, and clothes washers)
 - Blackwater (from toilets, combined with the human waste that it flushes away)
 - Soaps, detergents & toilet paper
- Rain/storm water/surface runoff





Drainage below ground

- Sewage infrastructure & systems
 - Collection: by a system of sewer pipes
 - Treatment: remove the contaminants to produce liquid and solid (sludge) suitable for discharge to the environment or for reuse
 - At central sewage treatment plants or on-site systems
 - Disposal: to rivers, streams or the sea
 - Reuse of treated or untreated sewage: e.g. reclaimed water, converted to biogas or fertilizer



Drainage below ground

- Basic design objectives
 - Operate without or minimal input of energy
 - Reliable and require little maintenance
 - Drains are not subject to undue stress
 - Fully accessible for occasional clearance
- Design calculations: based on flow rates, discharge units, gradients, pipe material & pipe diameter
 - Hydraulic calculation may be required



Drainage below ground

- System types
 - 1. Combined system (foul water + rainwater)
 - 2. Separate system
 - 3. Partially separate system
- Design considerations: costs, load on sewers
- Common fittings
 - Rainwater gully (RWG), yard gully (YG)
 - Inspection chamber (IC), rodding pod (RP)
 - Shoe and rest band (smooth connection)

Combined system

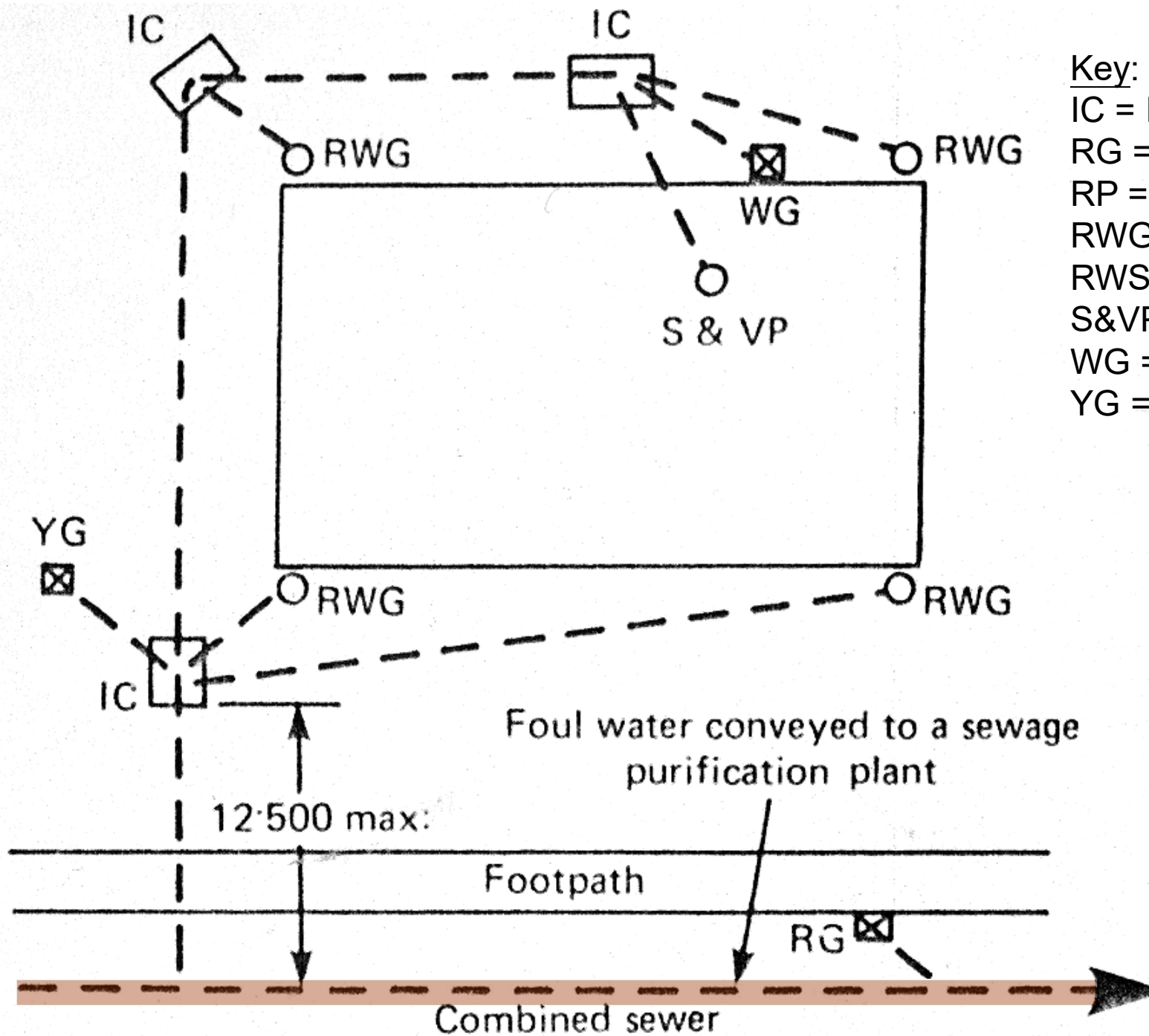

Key:

- IC = Inspection chamber
- RG = road gully
- RP = rodding pod
- RWG = rainwater gully
- RWS = rainwater shoe
- S&VP = soil & vent pipe
- WG = waste gully
- YG = yard gully

Separate system

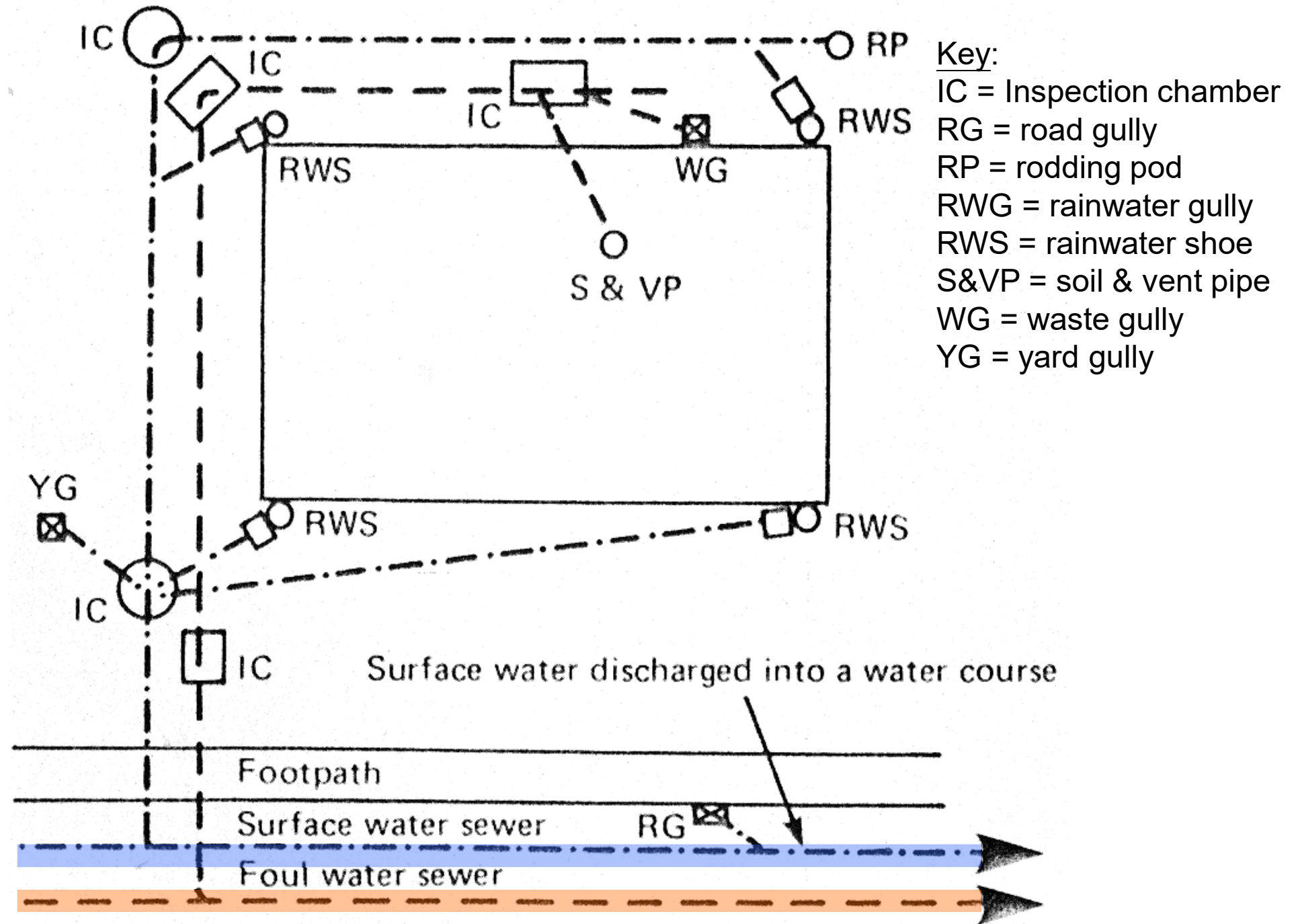

Partially separate system

What is the advantage of this?

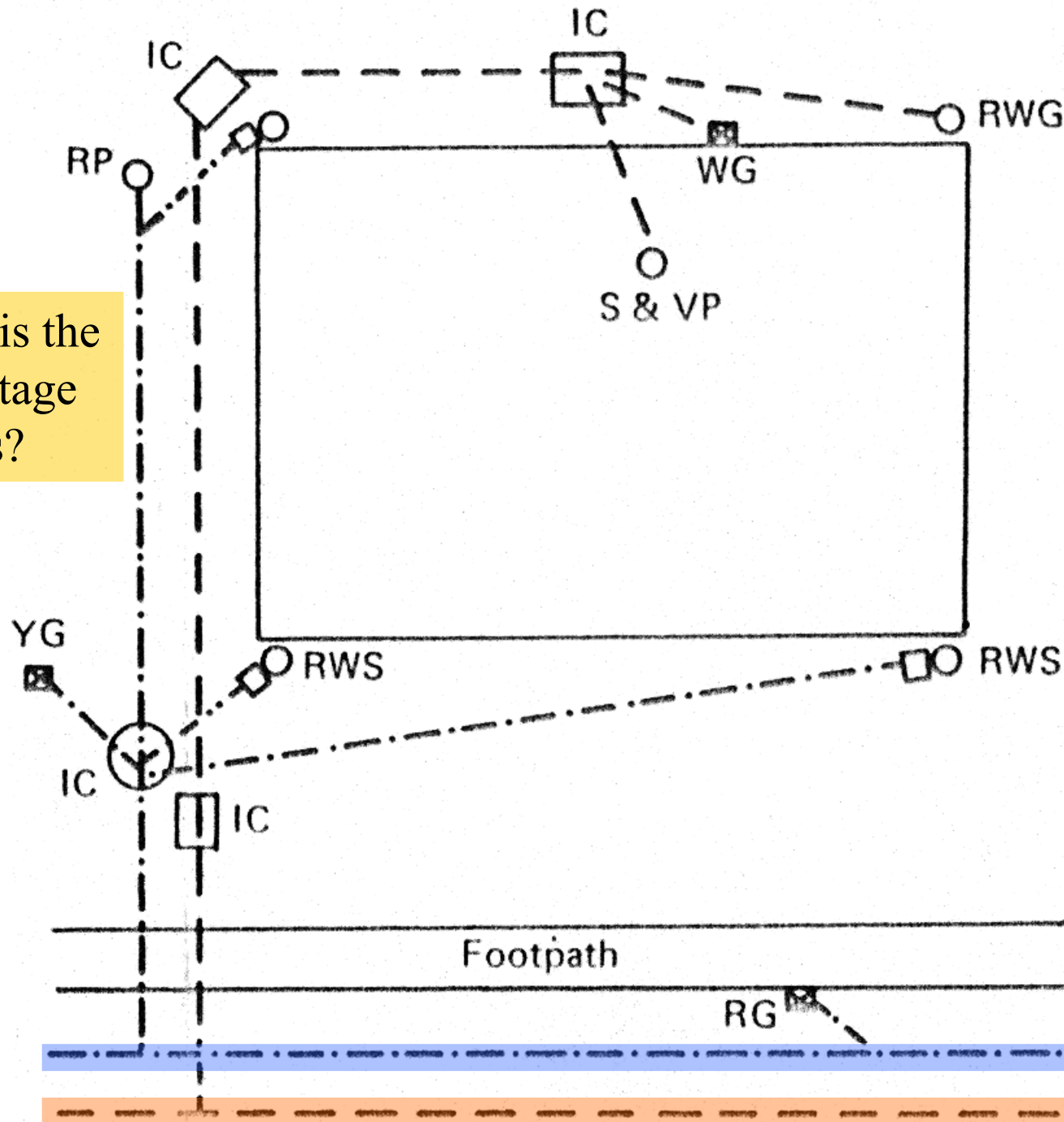

Key:

IC = Inspection chamber

RG = road gully

RP = rodding pod

RWG = rainwater gully

RWS = rainwater shoe

S & VP = soil & vent pipe

WG = waste gully

YG = yard gully

- Most of the surface water conveyed by a surface water drain to a surface water sewer or soakaway
- Some rainwater is discharged to the foul water drain. The rainwater can be conveniently connected to the foul water drain, usually at the rear of the building

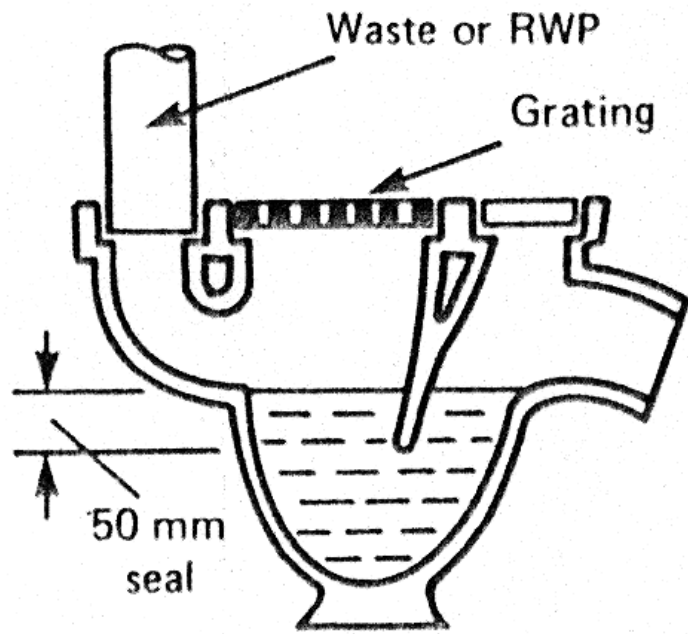

Waste or rainwater gully

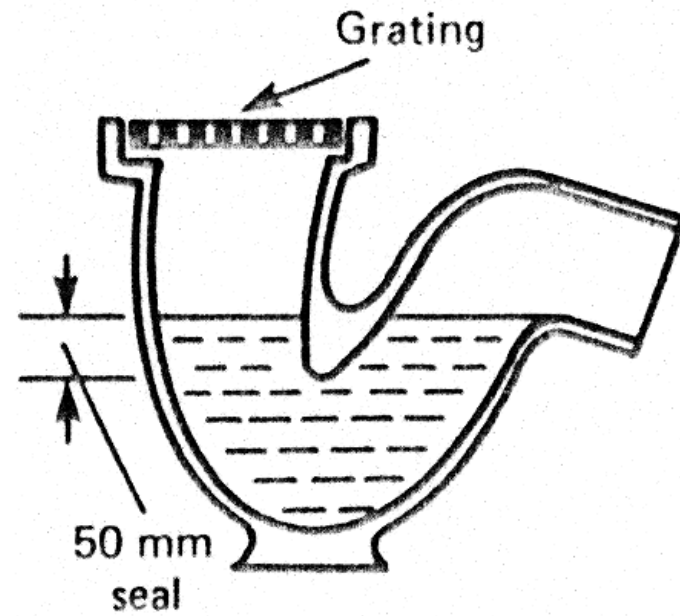

Yard gully

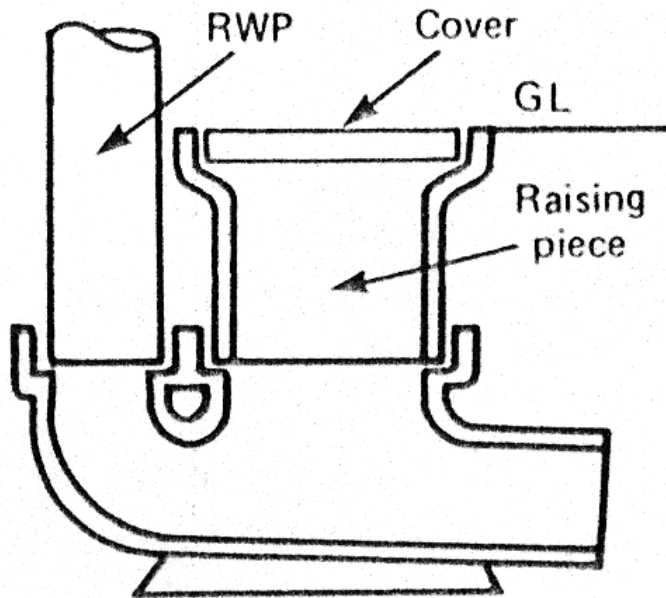

Rainwater shoe

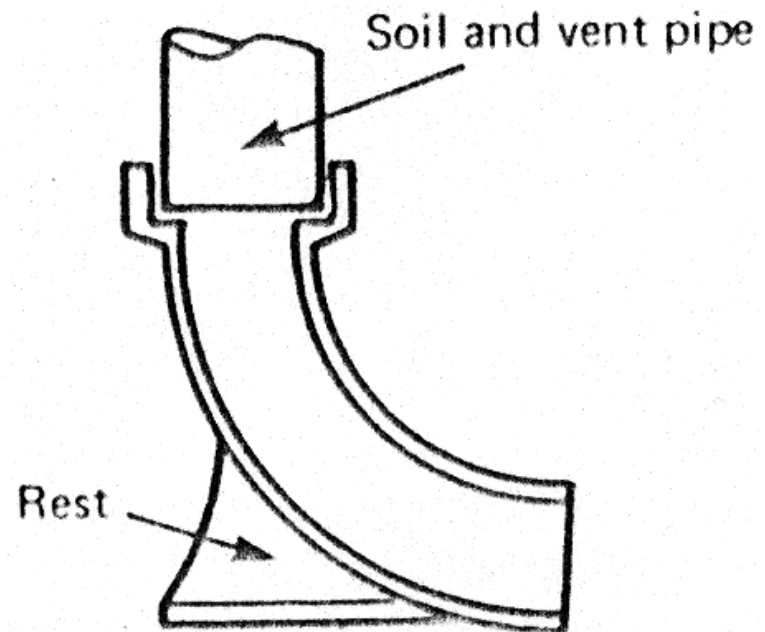

Rest bend

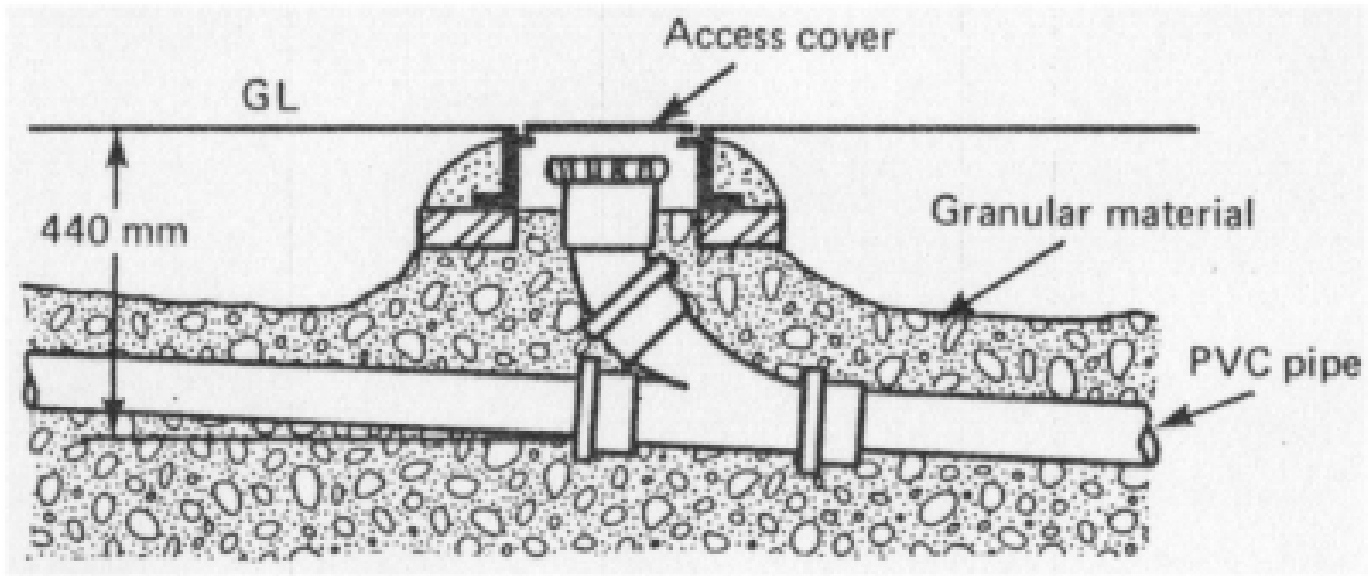

Shallow rodding point

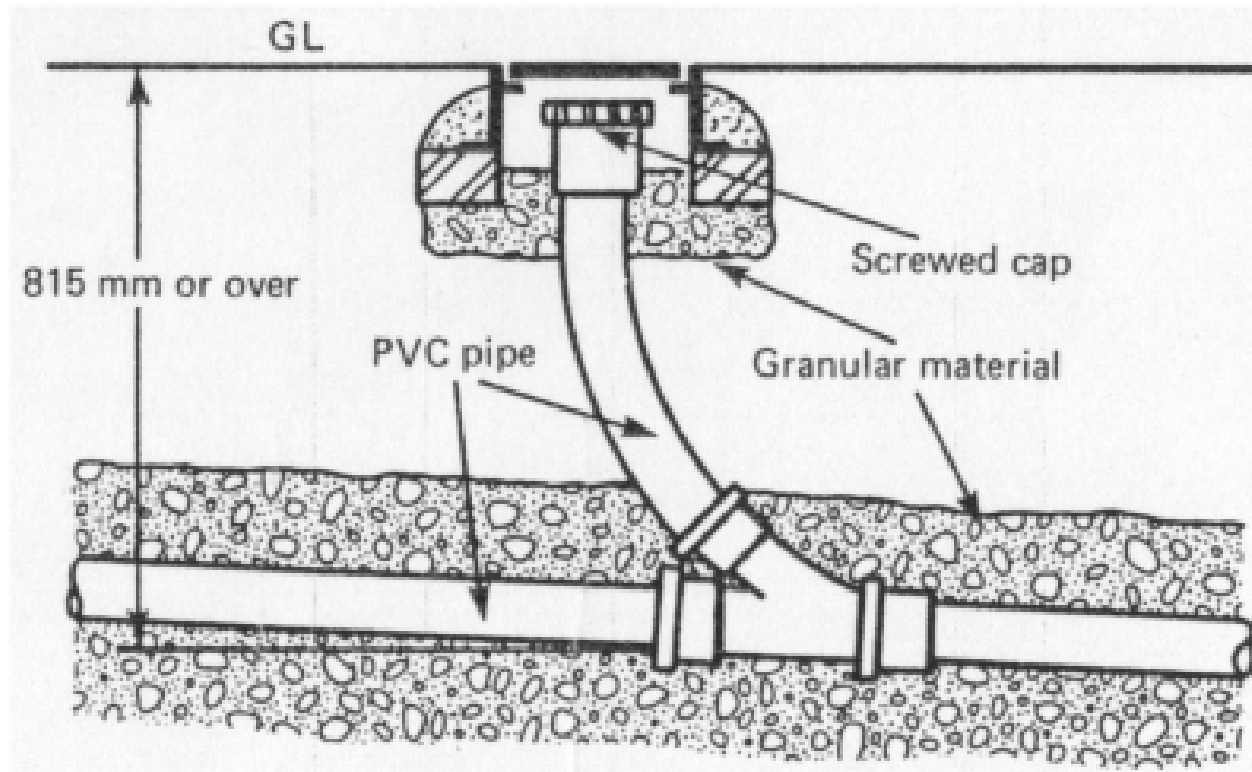

Deep rodding point



Drainage below ground

- Combined drainage system
 - Pros:
 - One drain for both foul & surface water reduces cost of drainage
 - No risk of making a wrong connection
 - Foul water flushed through the drain by the surface water
 - Cons:
 - The loss of a trap seal in a rainwater gully allows the foul gas from the drain to pass into the open air around the building
 - The size of the sewage disposal plant is greater
 - Greater cost of the sewage disposal
 - Possibly greater pumping costs (surface water and foul water to reach sewage disposal works)



Drainage below ground

- Separate drainage system
 - Pros:
 - Sewage disposal plant is much smaller
 - The cost of sewage purification is less
 - Less sewage is pumped → reduction in pumping cost
 - Surface water flow can be by gravity to a nearby river
 - Cons:
 - Two sets of drains increase the cost of building drainage
 - Risk of a wrong connection (a foul water branch drain to a surface water drain)
 - The foul water drain not thoroughly flushed by rainwater
 - Foul air passing through an unsealed rainwater gully trap

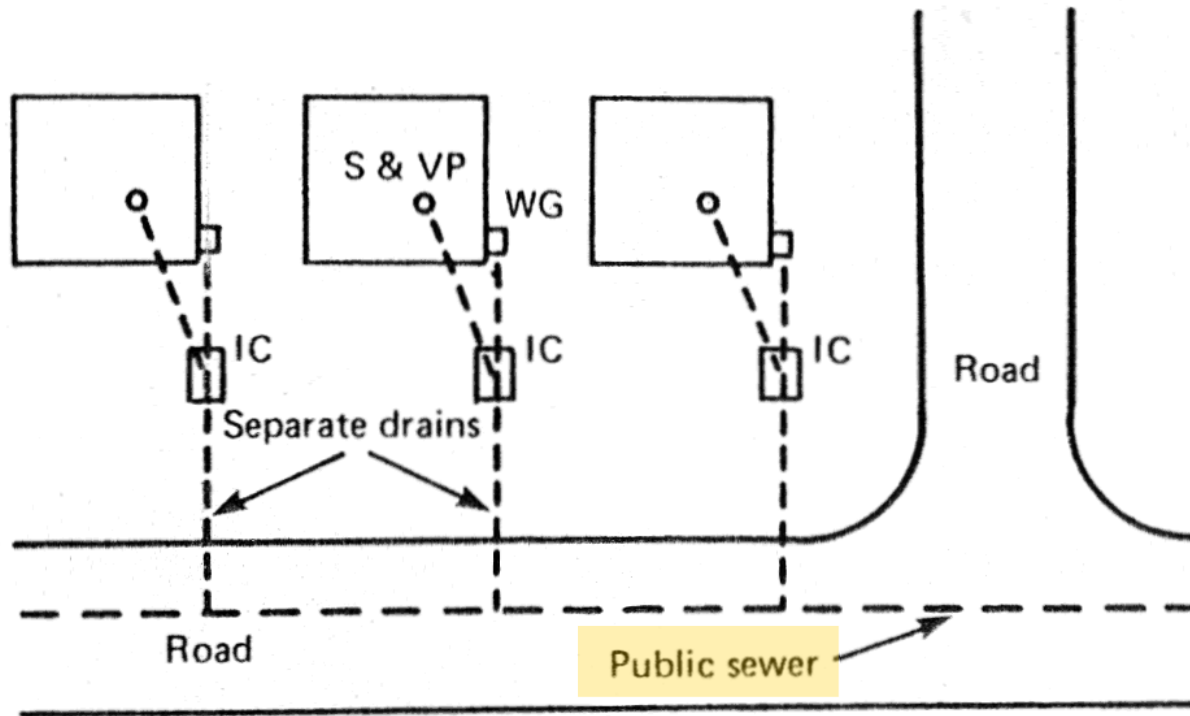

Use of
separate
drains

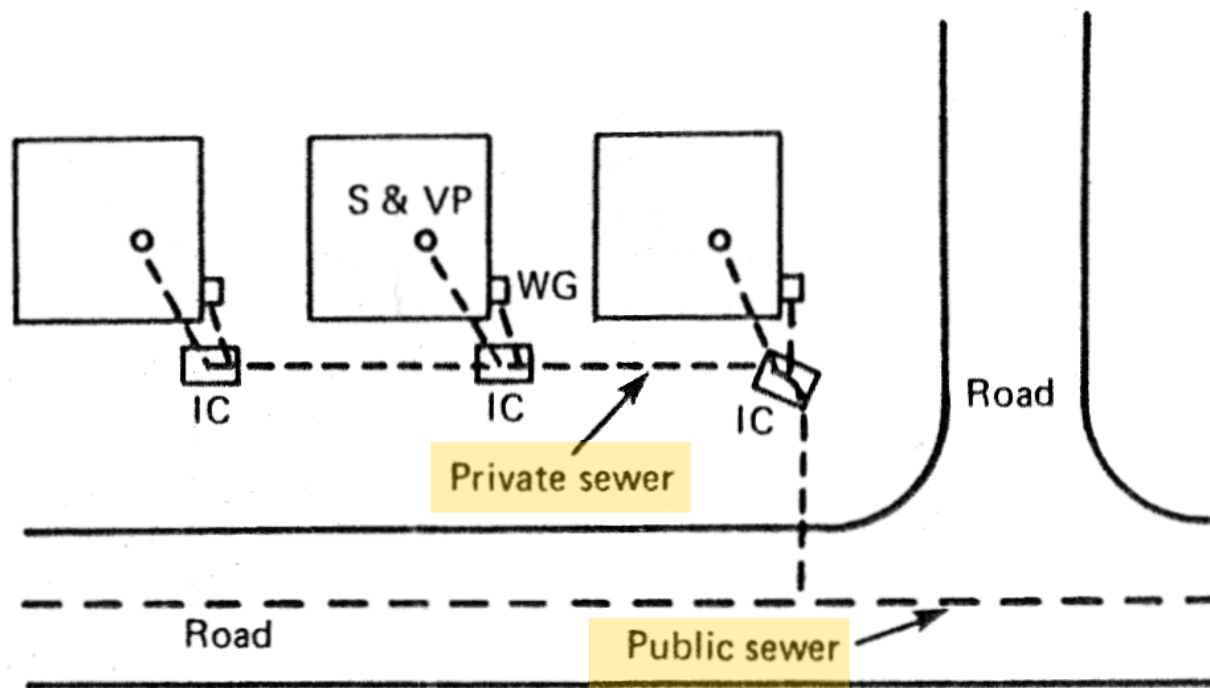

Use of
private
sewer



Drainage below ground

- Connection of drainage to sewer
 - Must be made obliquely in the direction of flow
 - Drain to another drain
 - Drain to a private sewer (私家污水渠)
 - Drain to a public sewer (公共污水渠)
 - Cost and maintenance issues
 - Private sewer/drain up to & include terminal manhole: paid by building owner
 - Public sewer & sewer linking the terminal manhole: paid by government/authority



Drainage below ground

- Stormwater or foul sewers?
 - Swimming pool main drain, footbath main drain and swimming pool make-up tank drain → **stormwater drains**
 - The filtration plant backwash → **foul sewers**
 - Drainage serving open transport interchanges and cargo handling areas → to **stormwater drains** (via petrol interceptor)
 - But allow stormwater bypass during peak flow periods



Drainage below ground

- Pipe materials and depth
 - A minimum diameter of 150 mm and be of the following materials or other approved materials:-
 - Foul sewer - vitrified clay, ductile iron, uPVC
 - Storm water drain - concrete, ductile iron, uPVC
 - Larger sewer: concrete
 - Smaller drains: clayware/uPVC
 - Drains should be laid at a depth of 900mm (minimum) under roads and at least 600mm below fields and gardens



Drainage below ground

- Underground drainage pipe
 - Foul sewers should be designed so that the velocity of the flow will exceed the self-cleansing velocity on a regular basis
 - As a general guide, the minimum fall of foul sewers is:
 - Pipe diameter 100 mm:- Fall 1:40
 - Pipe diameter 150 mm:- Fall 1:70
 - Pipe diameter 225 mm:- Fall 1:100
 - Pipe diameter 300 mm:- Fall 1:150



Drainage below ground

- Manholes (沙井)
 - They are required when
 - Pipes merge together
 - Change in direction >45 degree
 - Change in gradient
 - Maintenance, cleaning, inspection are needed



Sewage (small squares)



Stormwater (round & radical patterns)

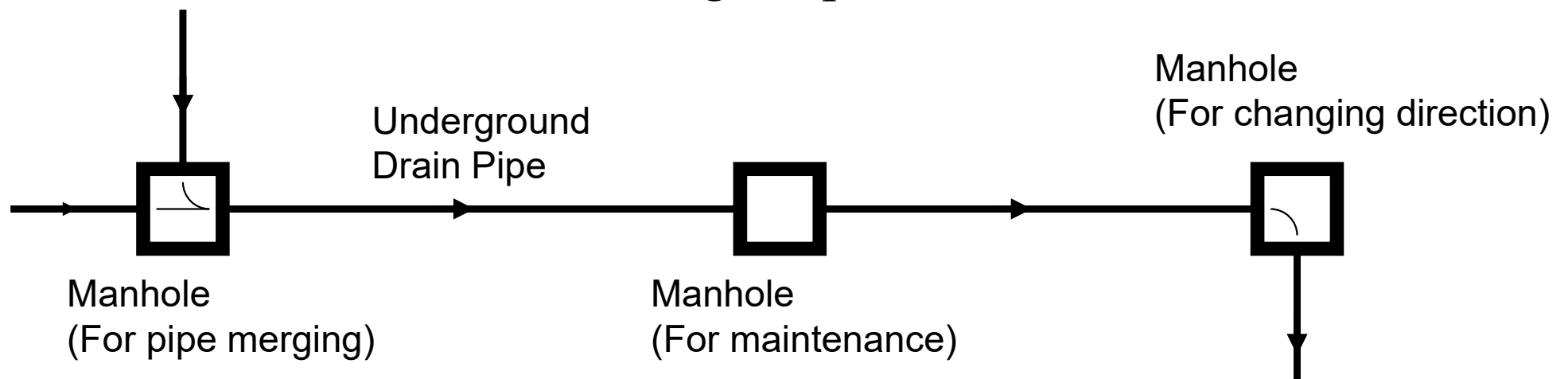

Manhole in plan view and manhole covers

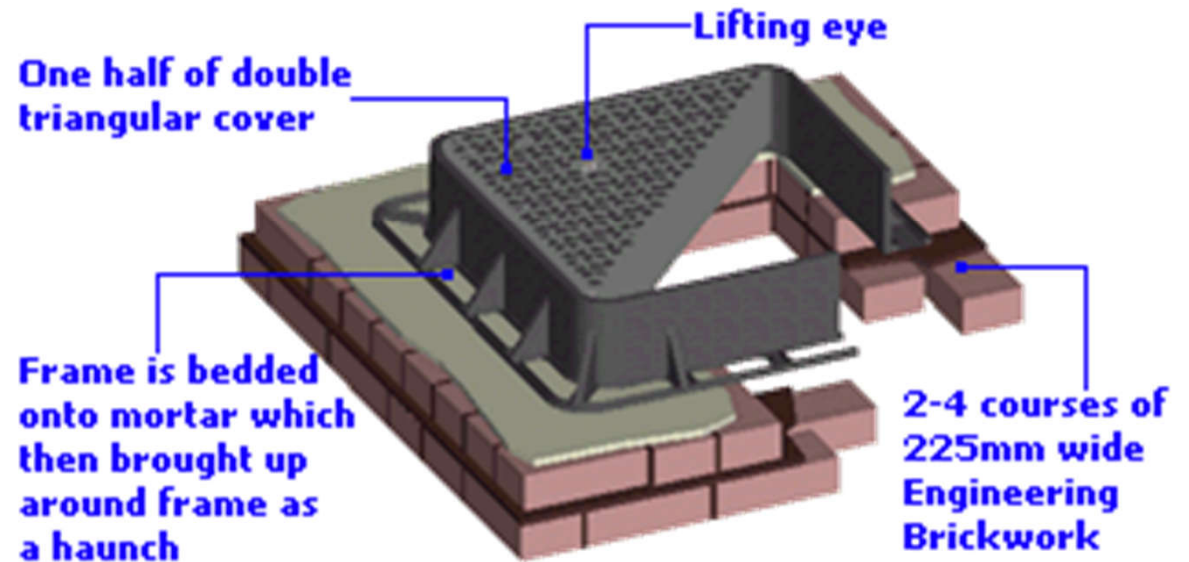
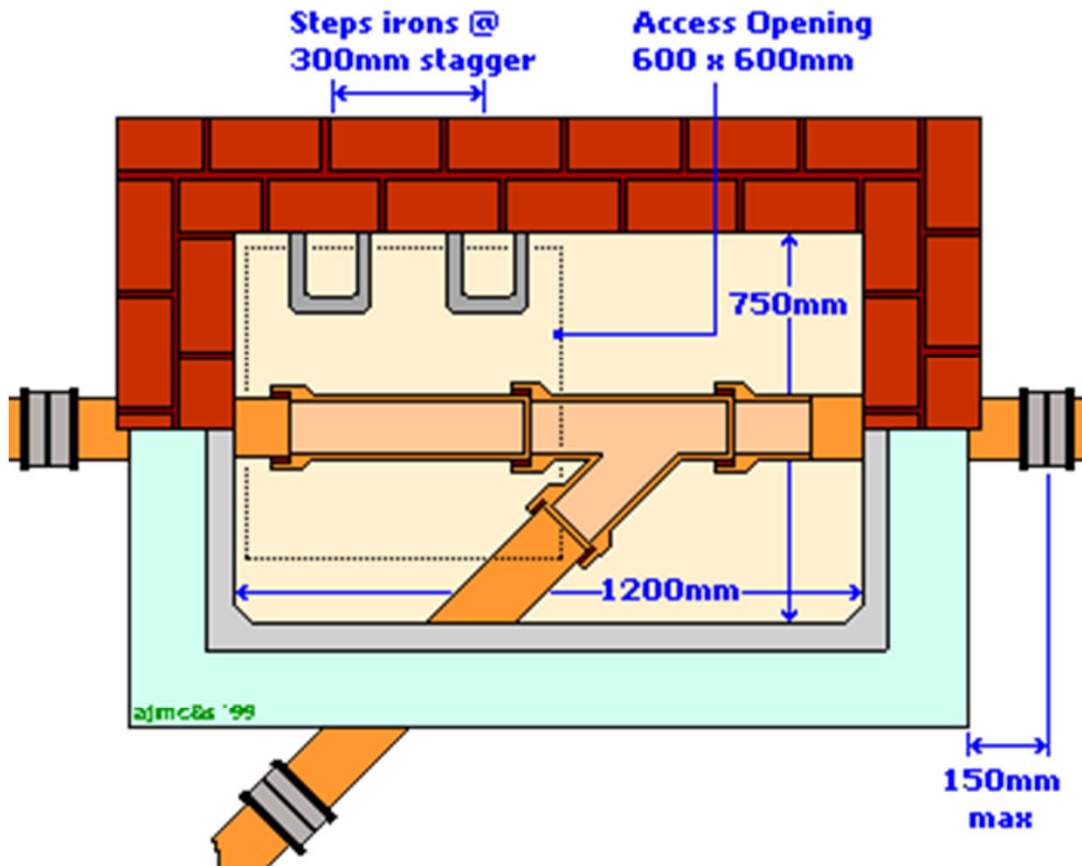



Drainage below ground

- Manholes (沙井) (cont'd)
 - Construction
 - 215 mm thick brickwork in cement mortar or 125 mm thick 1:2:4 reinforced concrete or other approved
 - Inside surface cement rendered
 - Cast iron cover (double-sealed airtight cover if inside or under a building)
 - See the standard drawings by DSD
 - Every building or project should have only one “terminal or last manhole” to public sewer

Standard manhole design

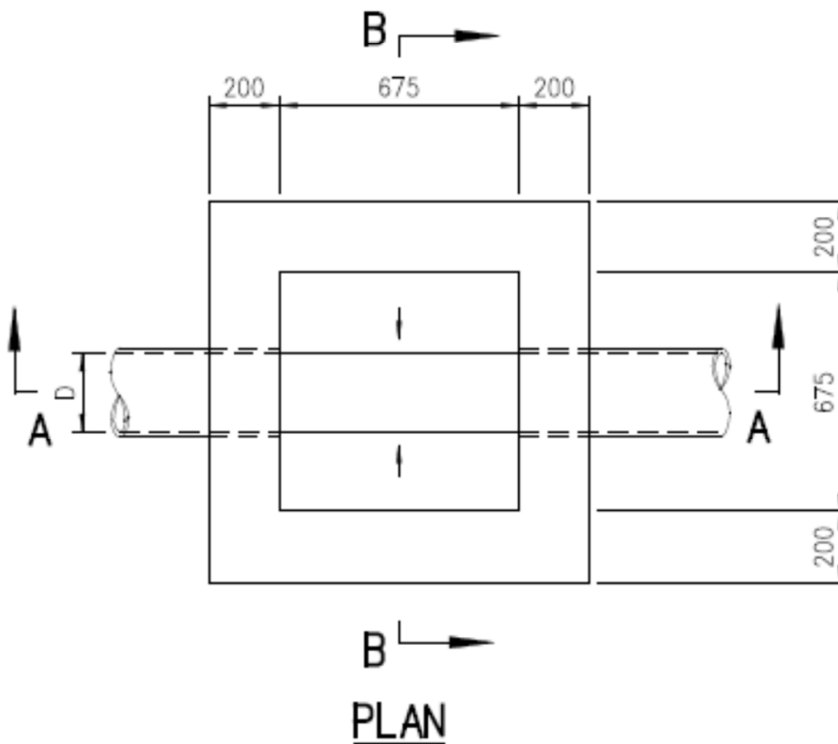
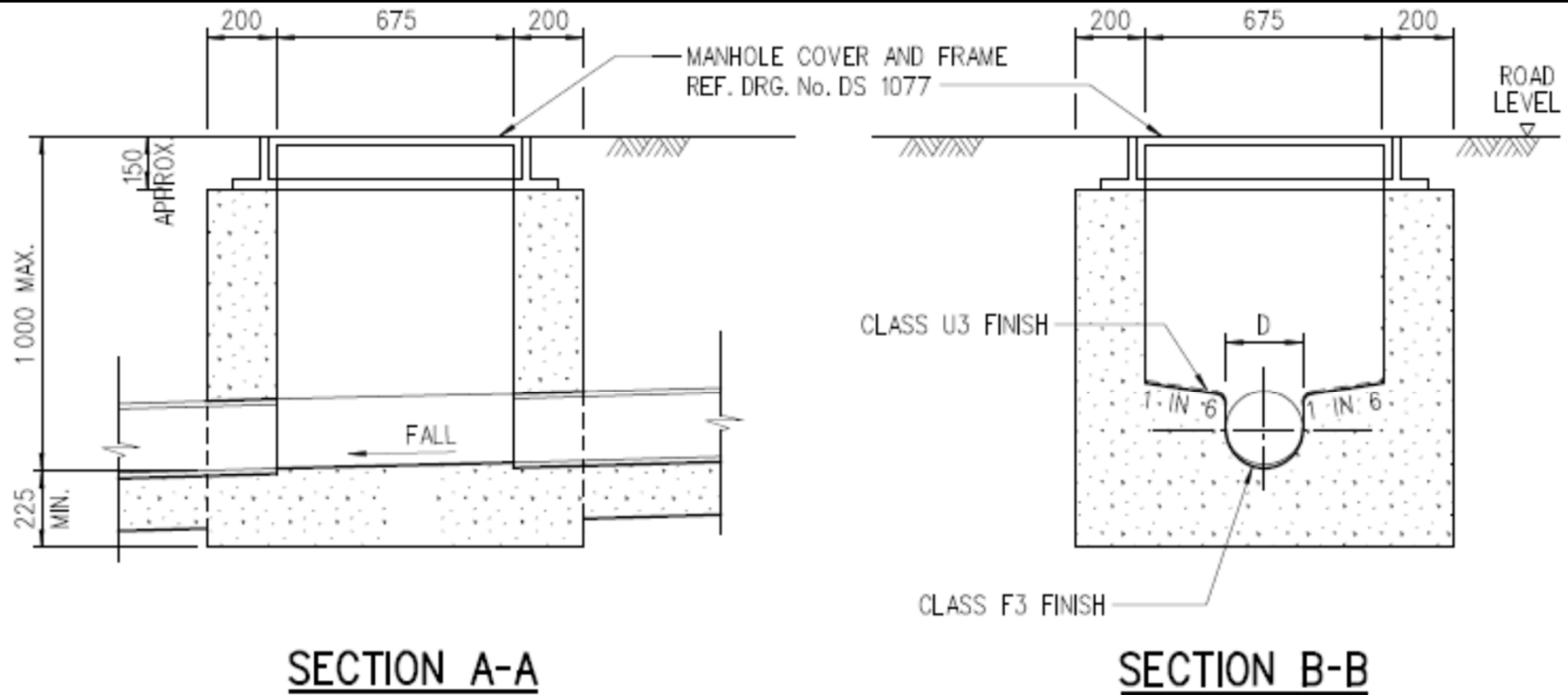

NOTES:

1. ALL DIMENSIONS ARE IN MILLIMETRES.
2. PIPE DIAMETER : 150 TO 300 mm
3. NORMAL RANGE OF DEPTH : MAX. 1000 mm (MEASURED FROM ROAD LEVEL TO LOWEST INVERT)
4. USED IN : STORMWATER DRAIN AND SEWER
5. JUNCTION : POSITION OF JUNCTION TO BE DETERMINED IN INDIVIDUAL CASE.
6. TOP TREATMENT : SEE DRG. No. DS 1032
7. FOUNDATION : FOUNDATION OF MANHOLE VARIES WITH SITE CONDITION. THEREFORE, IT SHOULD BE DETERMINED ON SITE BY THE ENGINEER.
8. CONCRETE : GRADE 30/20
9. COVER AND FRAME NOT SHOWN ON PLAN FOR CLARITY

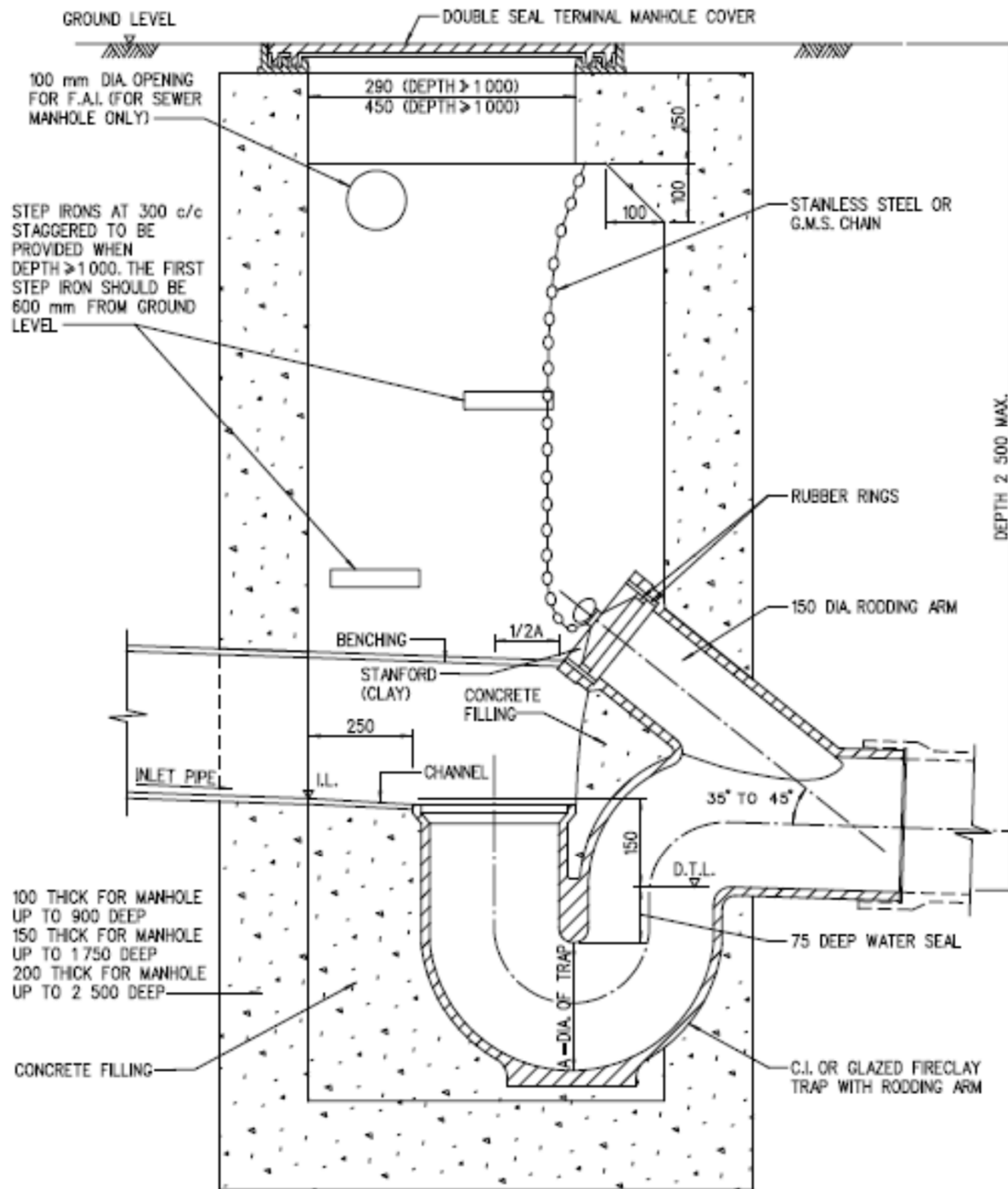

Terminal manhole, typical characteristics:

- Trapped
- Rodding arm for cleaning
- Opening for fresh air intake (FAI)
- Steps for maintenance

Double-sealed manhole cover

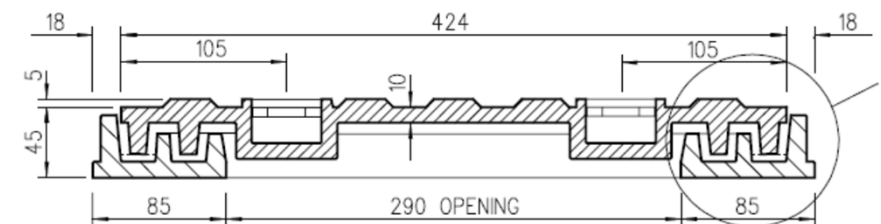

Testing & sewage pumping

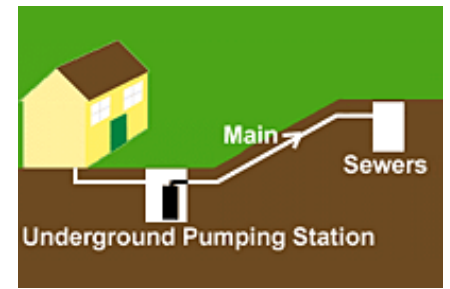

- Acceptance tests of drainage systems

- 1. Air test

- With hand pump and stoppers

- 2. Smoke test

- With smoke machine and stoppers

- 3. Water test (most common for u/g drains)

- Seal ends of drains & connections with approved plugs
 - Fill with water to produce 1.5m head at high end
 - Allow for initial absorption
 - Measure loss of water over 30 minutes

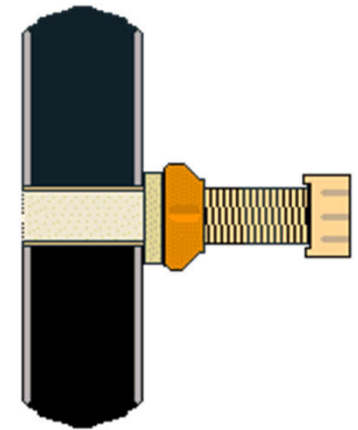

Air test on drains

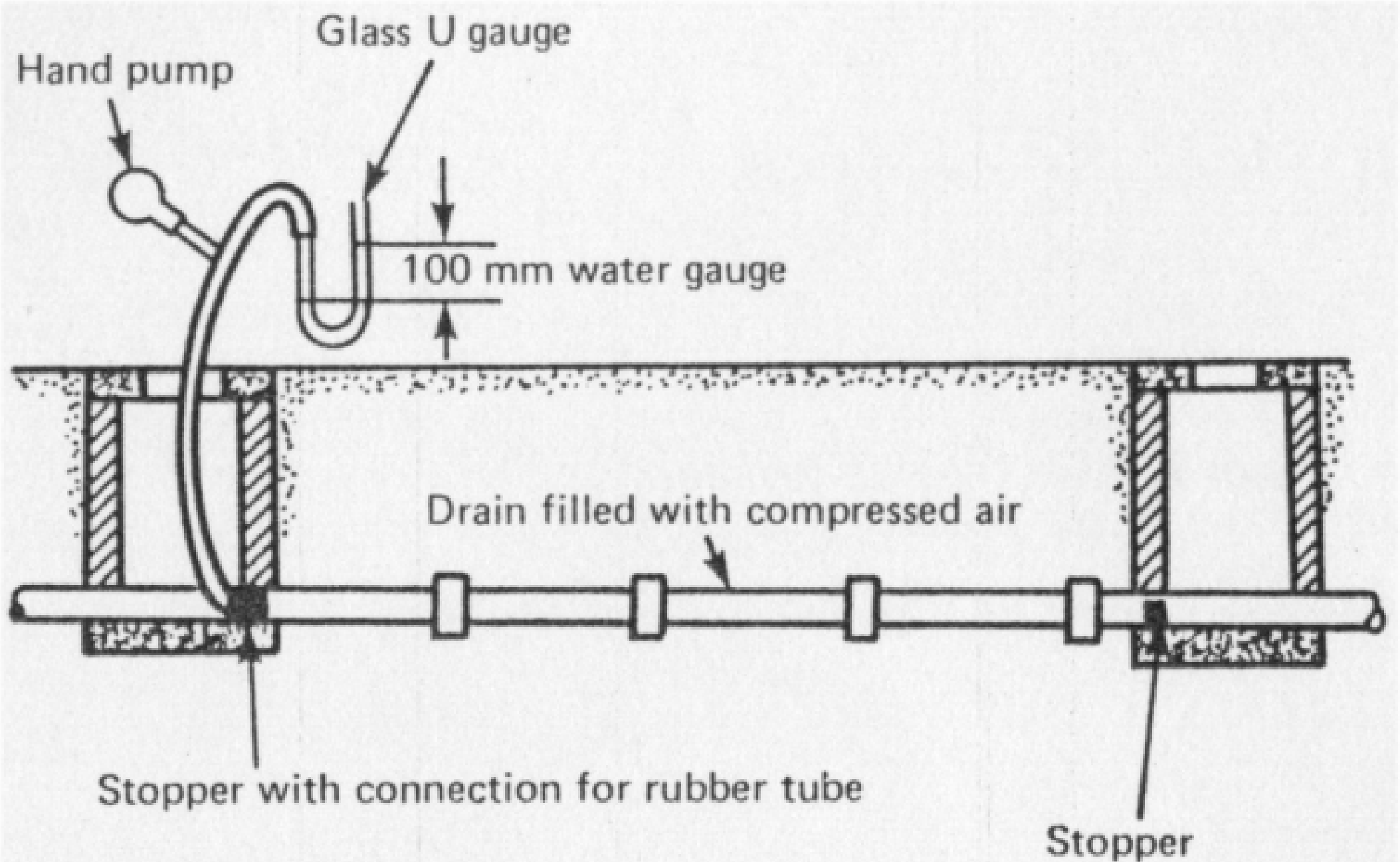

Set up of air testing on drains

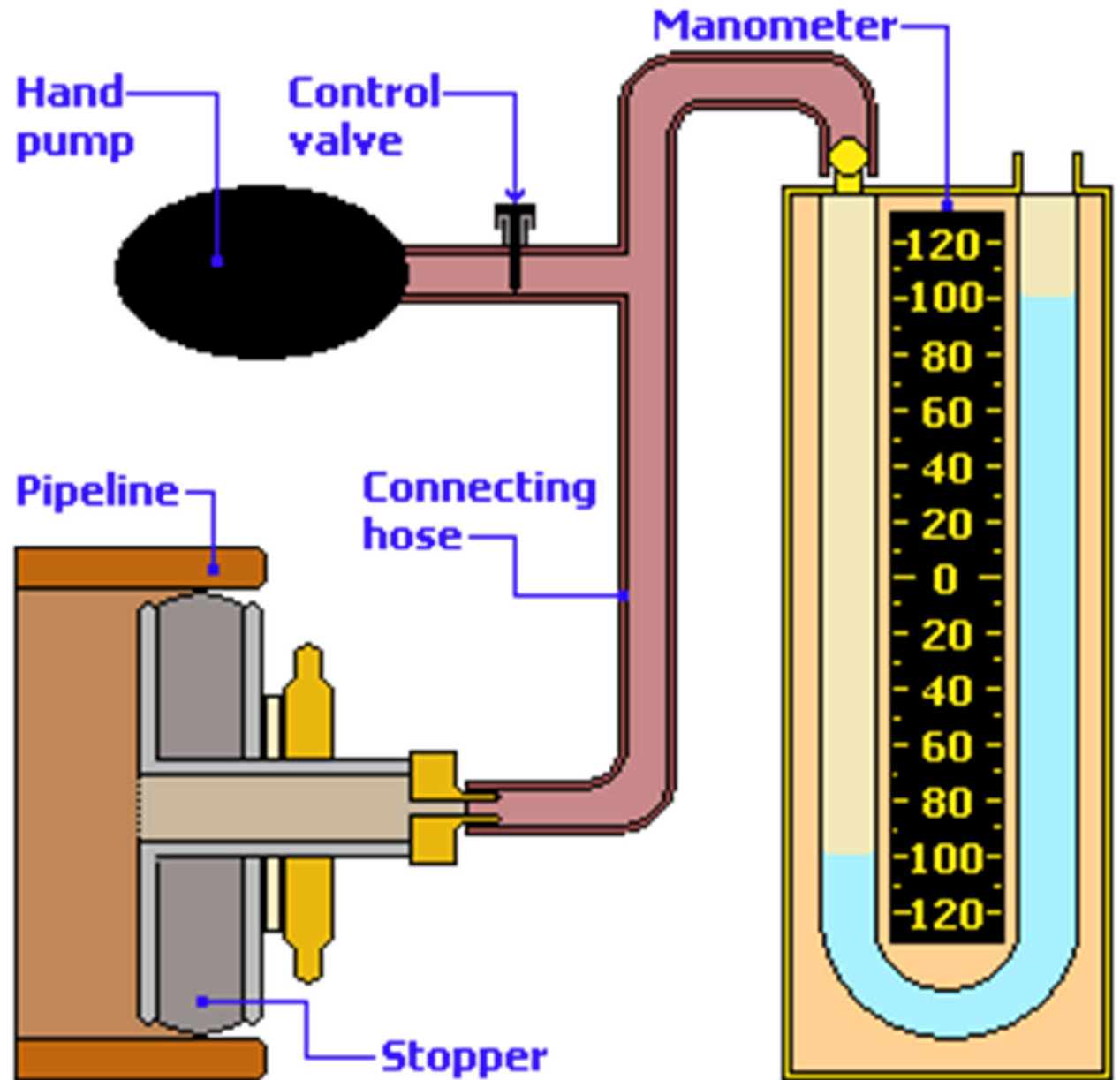

Smoke test on drains

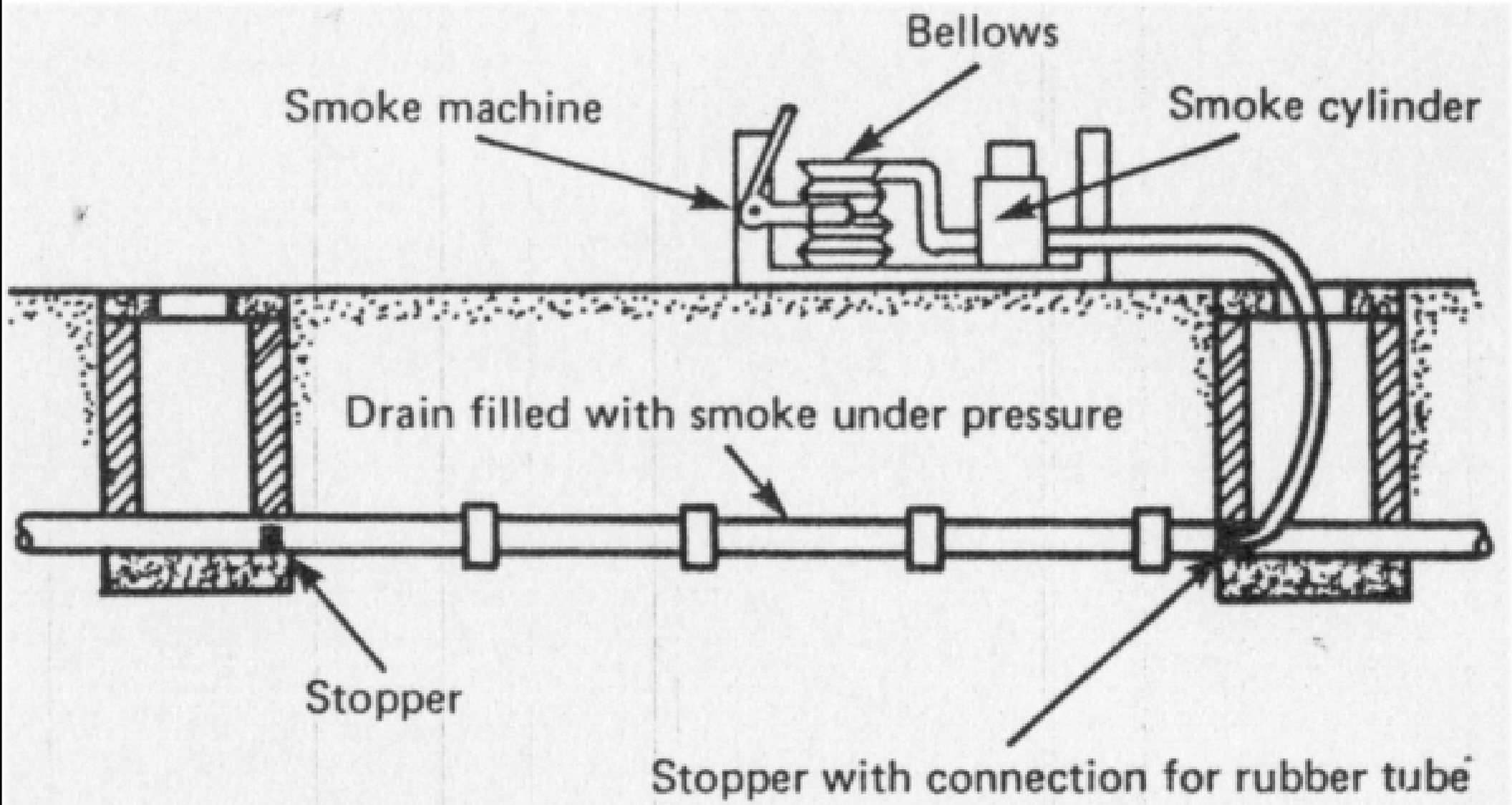

Water test on drains

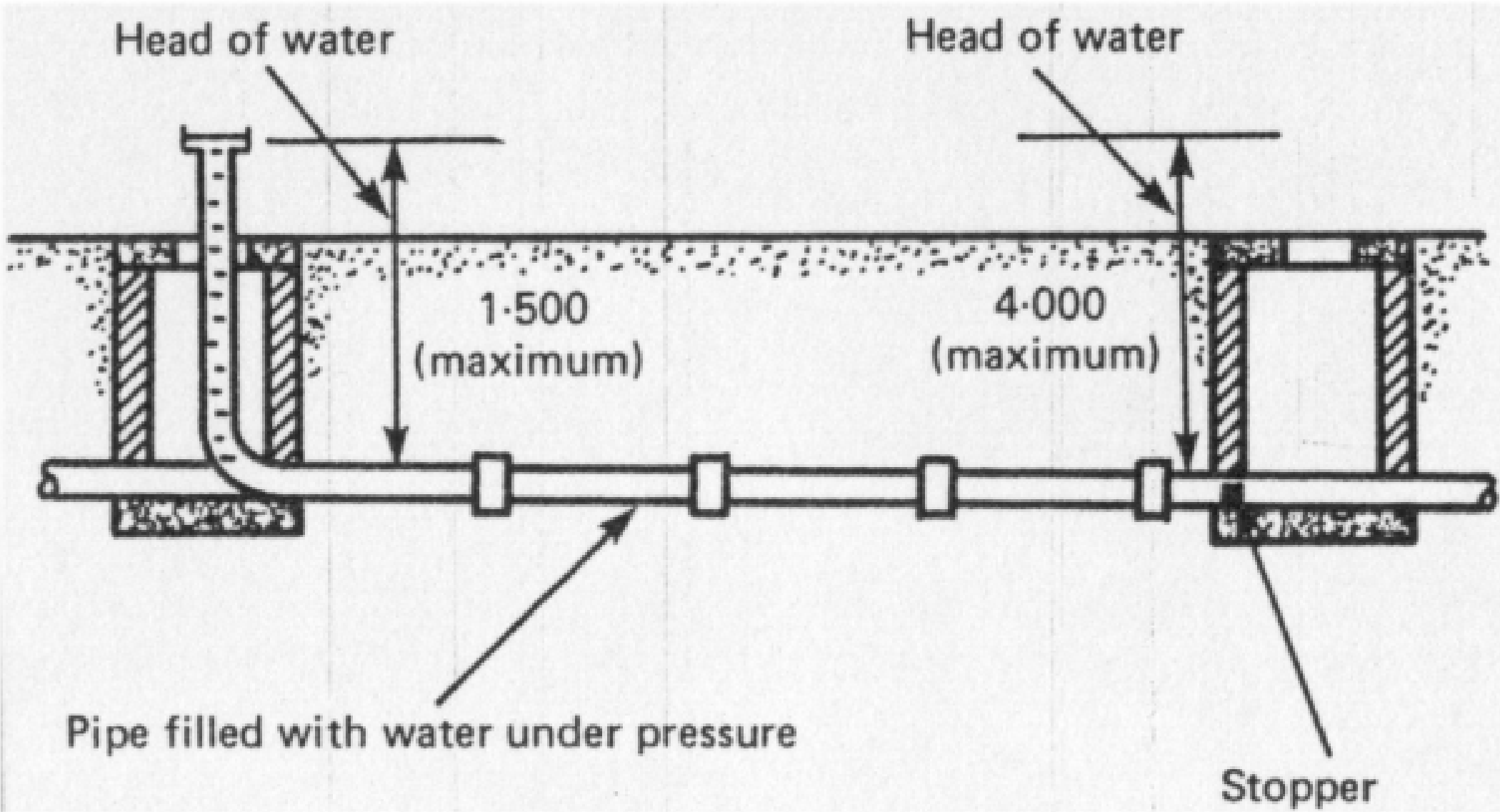

(Source: Hall, F. and Greeno, R., 2008. *Building Services Handbook*)

Testing & sewage pumping

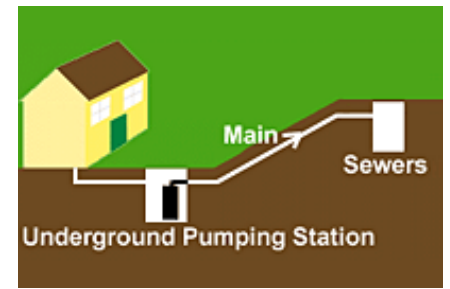

- Whenever possible, gravity flow should be used for drainage & sewage
- If site levels do not permit, sewage pumping stations can be used, such as those with centrifugal pumps
 - Installed below the fluid (self-priming)
 - Impeller curved on plan to reduce risk of blockage
 - Discharge pipe pass into a manhole before connected to public sewer

Basic concept of sewage pumping station

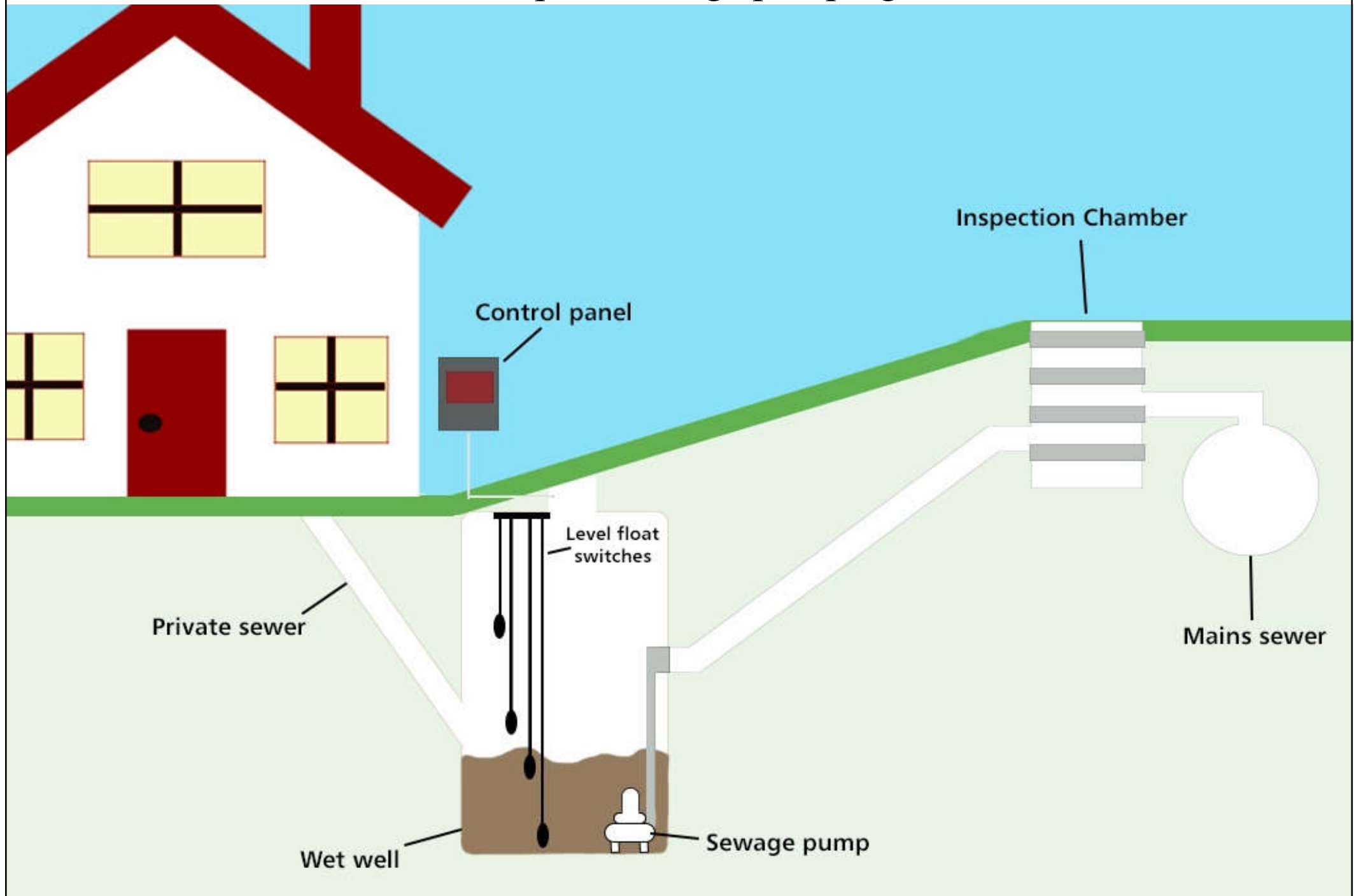

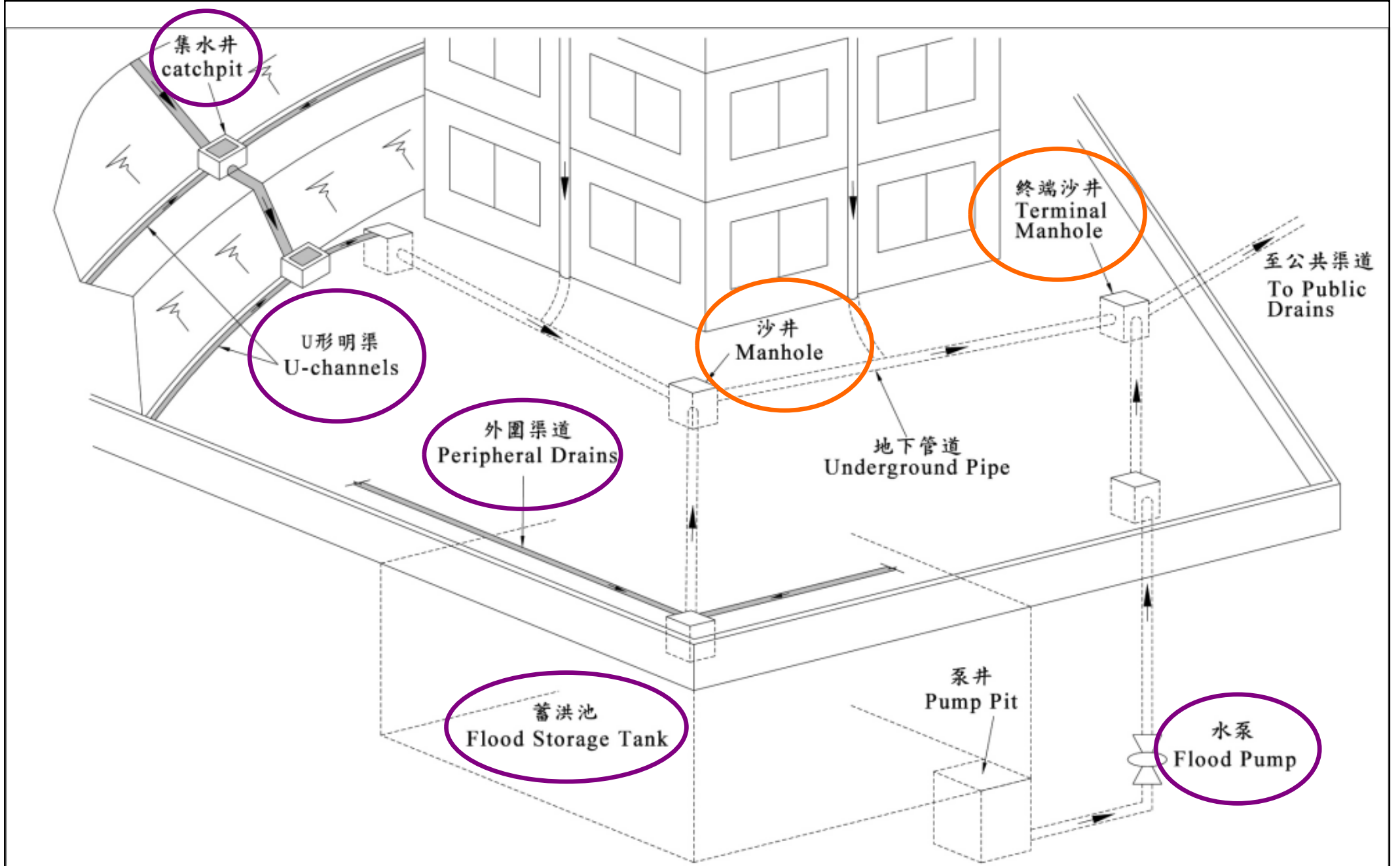

drawing title 圖則名稱

排水系統的常見部份

Common Components of a Drainage System

drawing no. 圖則編號

圖一
Figure 1

scale 比例

不依比例
N.T.S.

date 日期

二〇〇三年四月
Apr 03

office 部門

土地排水部
LAND DRAINAGE DIVISION



DRAINAGE SERVICES
DEPARTMENT
渠務署

(Source: Drainage Services Department, www.dsd.gov.hk)

Sewage pumping station using a centrifugal pump

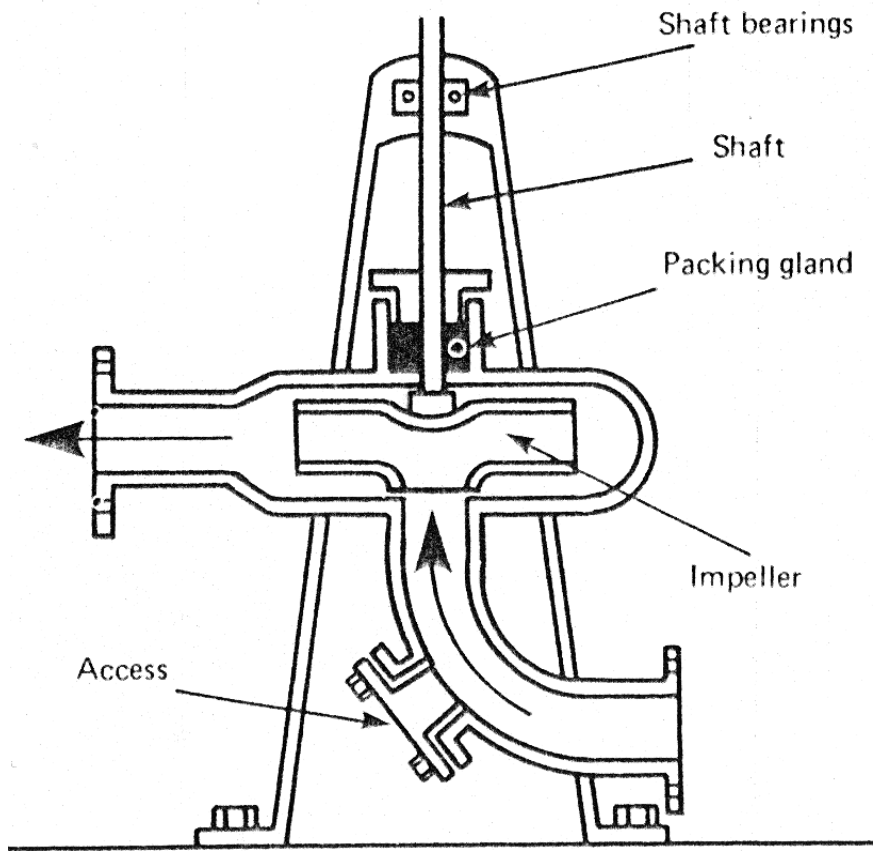
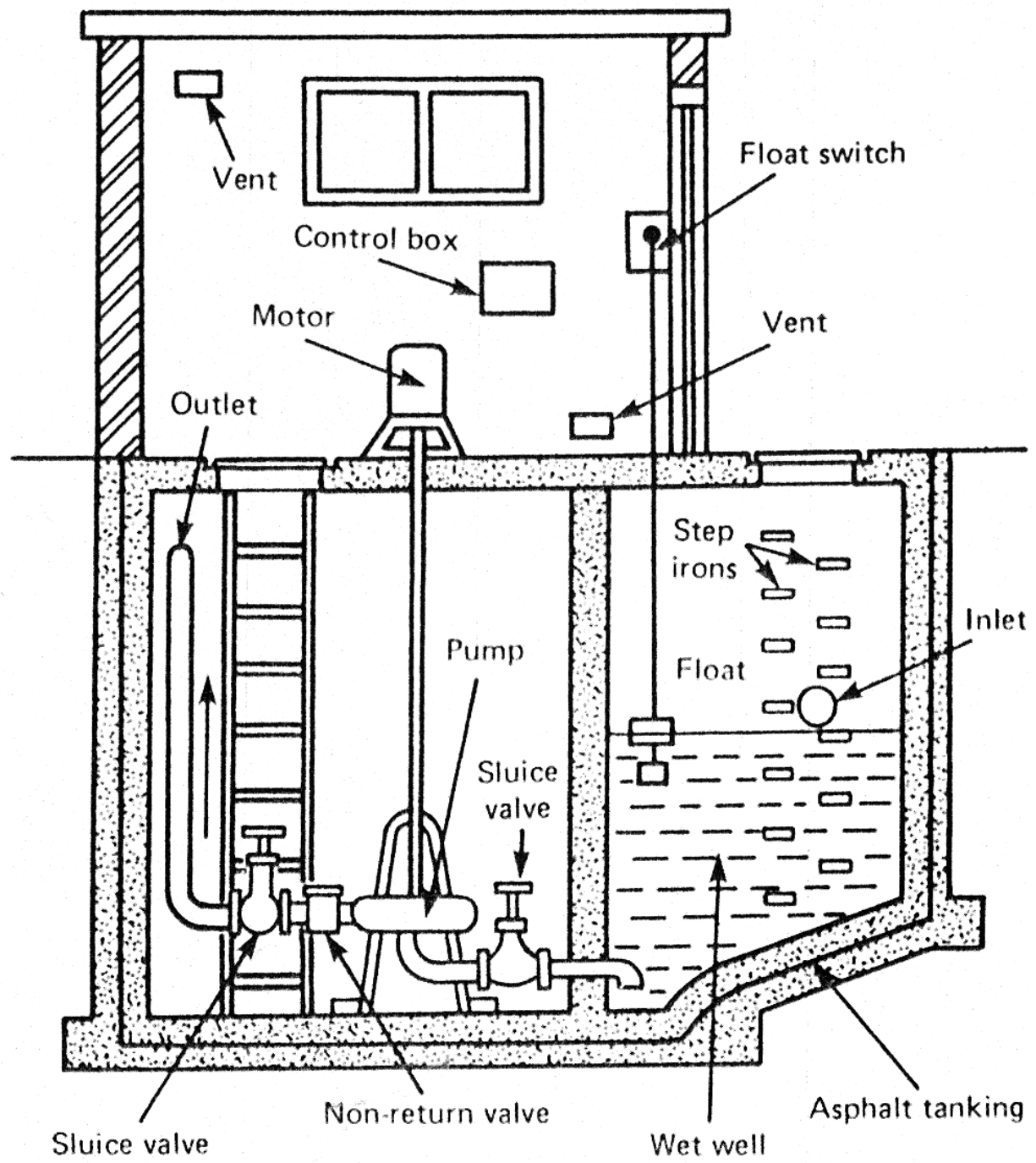

(Source: Hall, F. and Greeno, R., 2008. *Building Services Handbook*)

Testing & sewage pumping

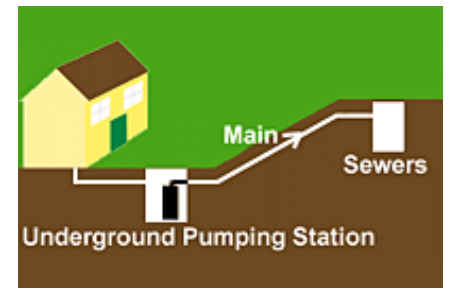

- Sewage ejector may replace centrifugal pump in the sewage pumping station
 - Less risk of blockage
 - Fewer moving parts and less maintenance
 - A wet well is not required
 - One compressor unit can supply compressed air to several ejectors

Sewage pumping station using an ejector

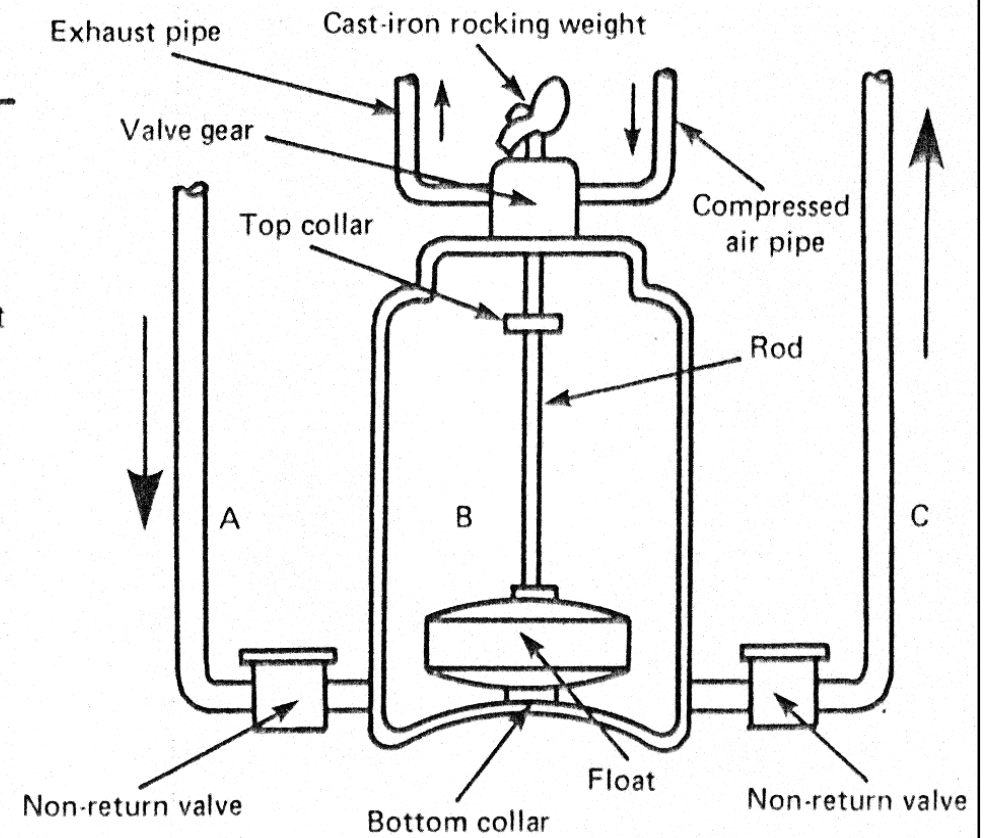
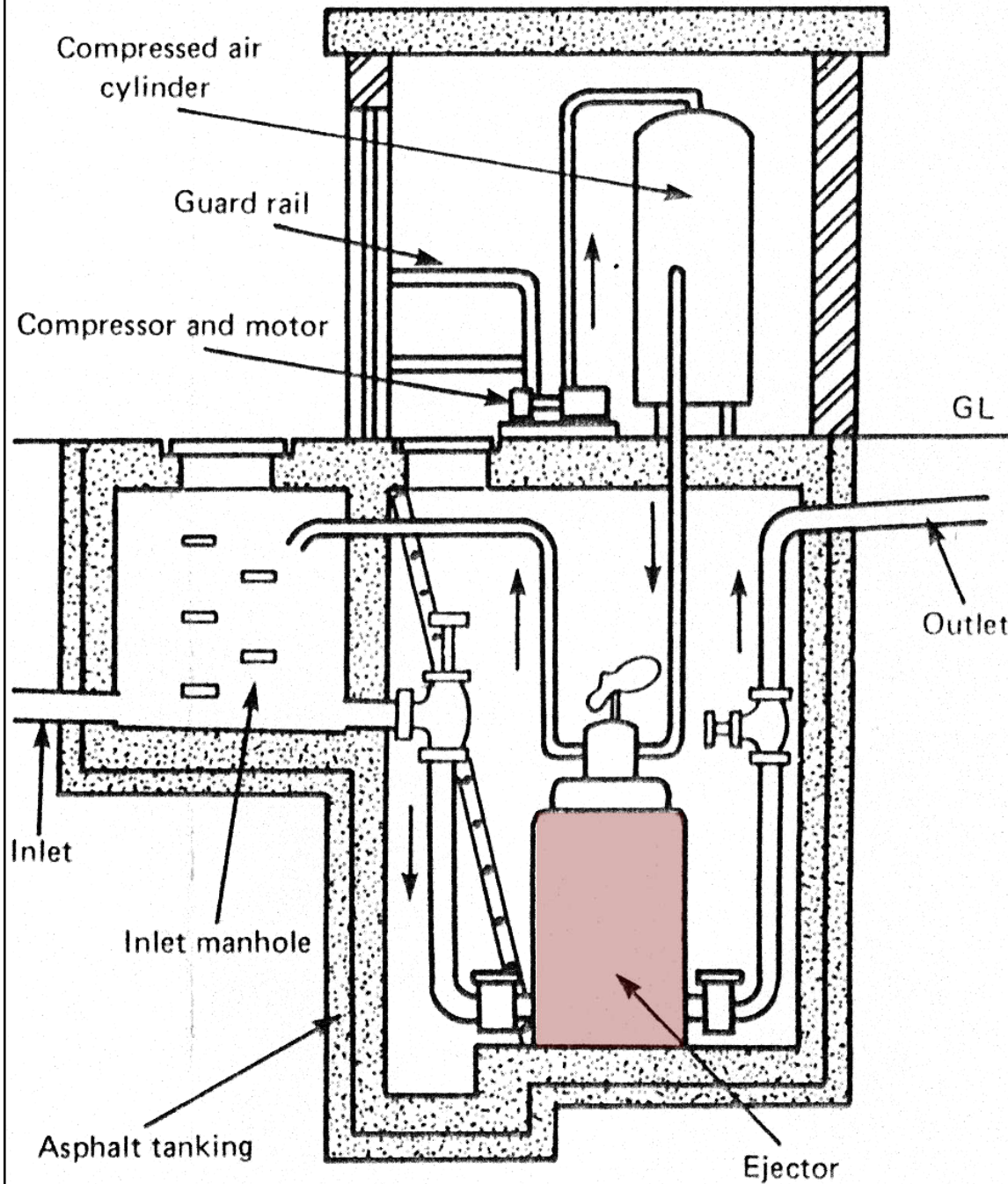

Testing & sewage pumping

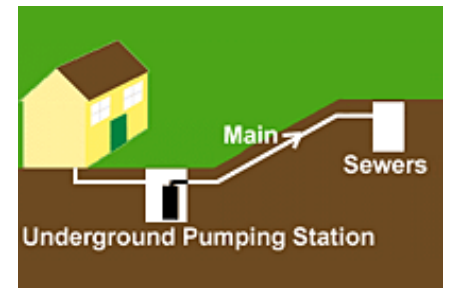

- Design considerations
 - Information required
 - Type of the drainage flow
 - Maximum quantity of flow per hour
 - Height to which the fluid has to be lifted
 - Length of delivery pipe
 - Type of electric supply (a.c. or d.c.)
 - Motor room below ground level
 - Much neater and the noise can be isolated
 - Sump pump needed to remove water seepage/leakage



Underground pump room and sump pump

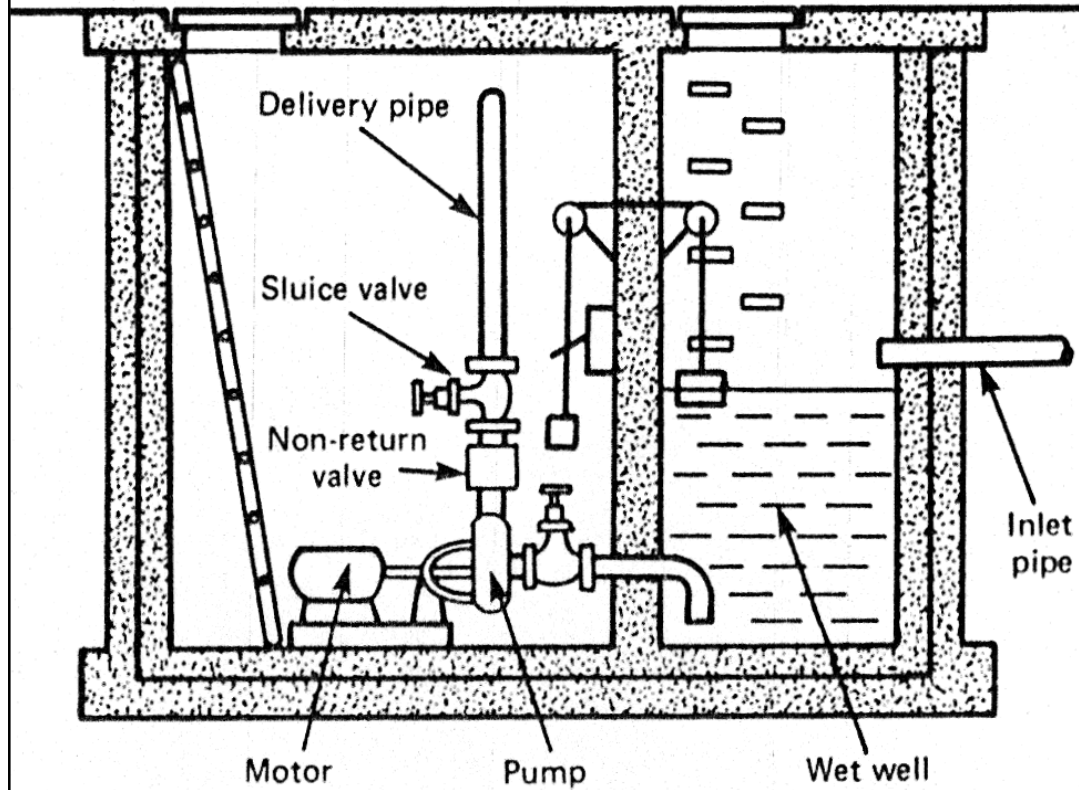

Underground pump room

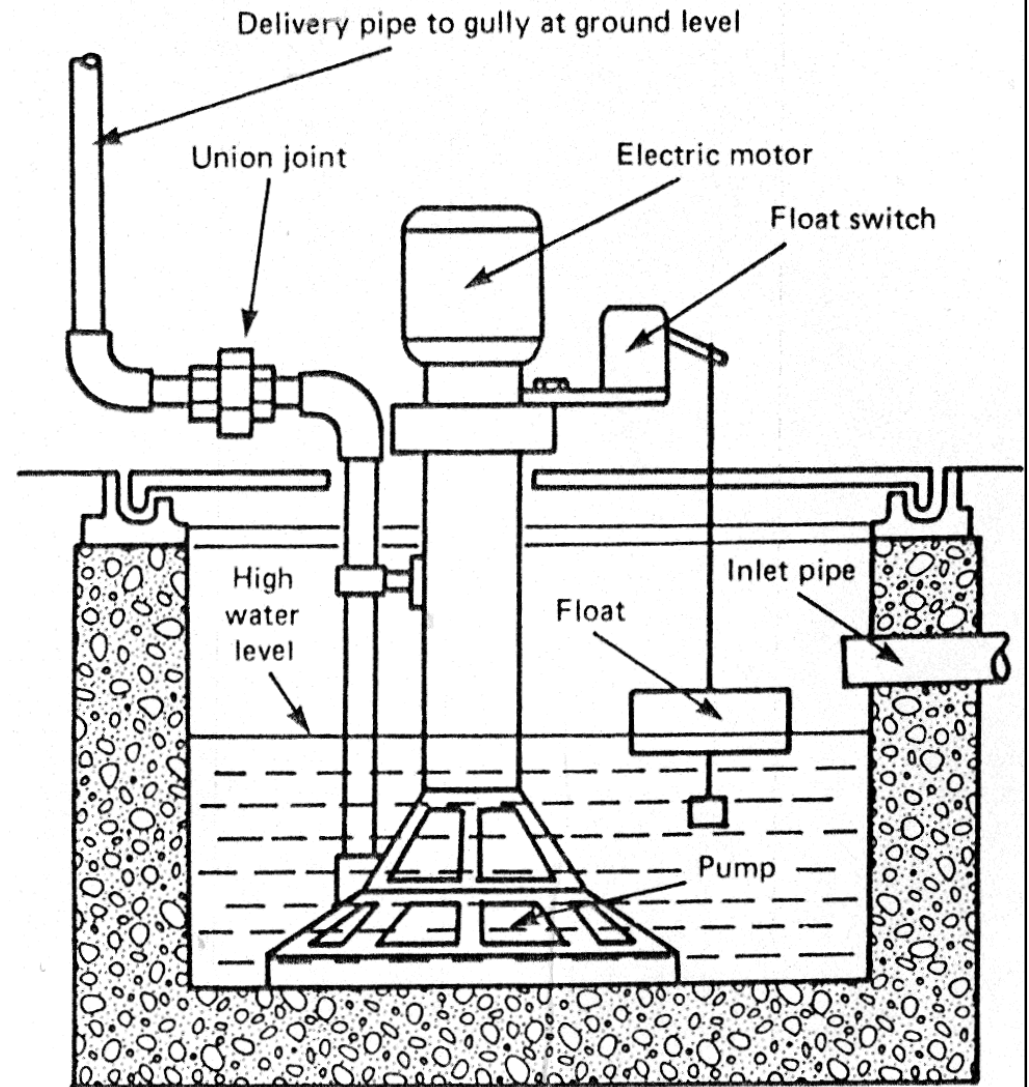

Sump pump

Illustration of a faecal lifting plant to a drain

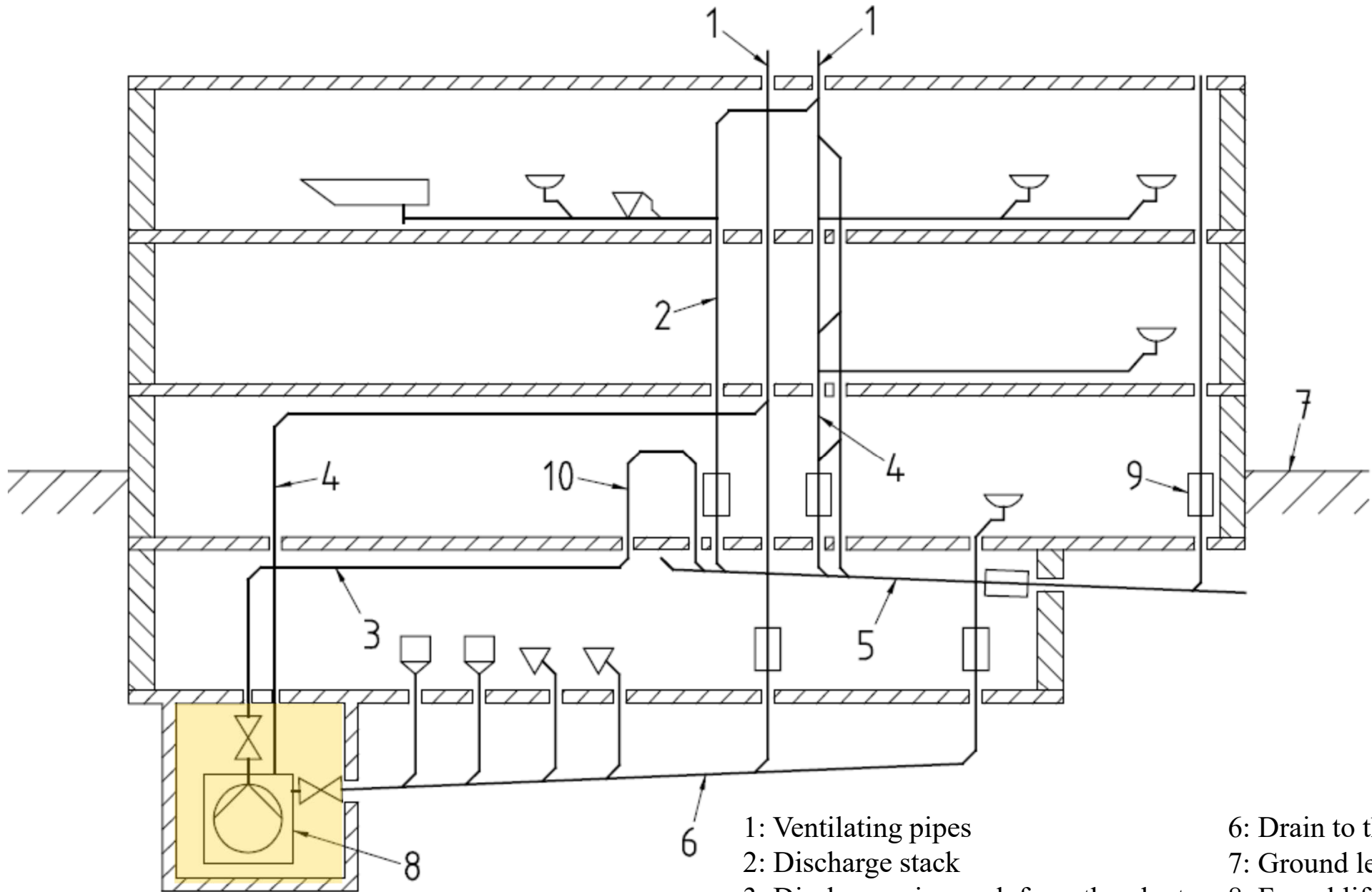

- | | |
|--------------------------------------|-------------------------|
| 1: Ventilating pipes | 6: Drain to the plant |
| 2: Discharge stack | 7: Ground level |
| 3: Discharge pipework from the plant | 8: Faecal lifting plant |
| 4: Ventilating pipe for the plant | 9: Access point |
| 5: Drain | 10: Backflow loop |

Testing & sewage pumping

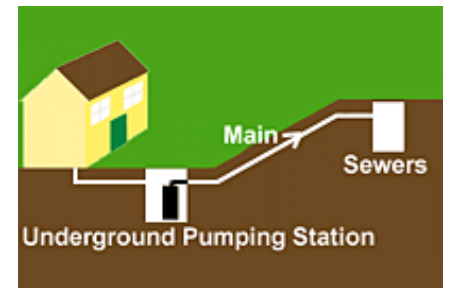

- Classification of sewage pumping stations
 - (a) Wet well/dry well pumping stations
 - (b) Submersible pumping stations
 - (c) Screw pumping stations (or Archimedean screw pumping station)
- Design considerations
 - Land/space requirements, structural design
 - Electrical system supply
 - Odour & noise control

Methods of sewage disposal



- Controlling water pollution from sewage in Hong Kong
 - Connections to Sewers Under the Water Pollution Control Ordinance
 - https://www.epd.gov.hk/epd/english/environmentinhk/water/guide_ref/guide_wpc_csuw.html
 - Connect to public sewers leading to government treatment plants (Drainage Services Department)
 - In rural areas not served by public sewers, private developers need to provide their own sewage treatment facilities

Arrangement for connection of village sewer

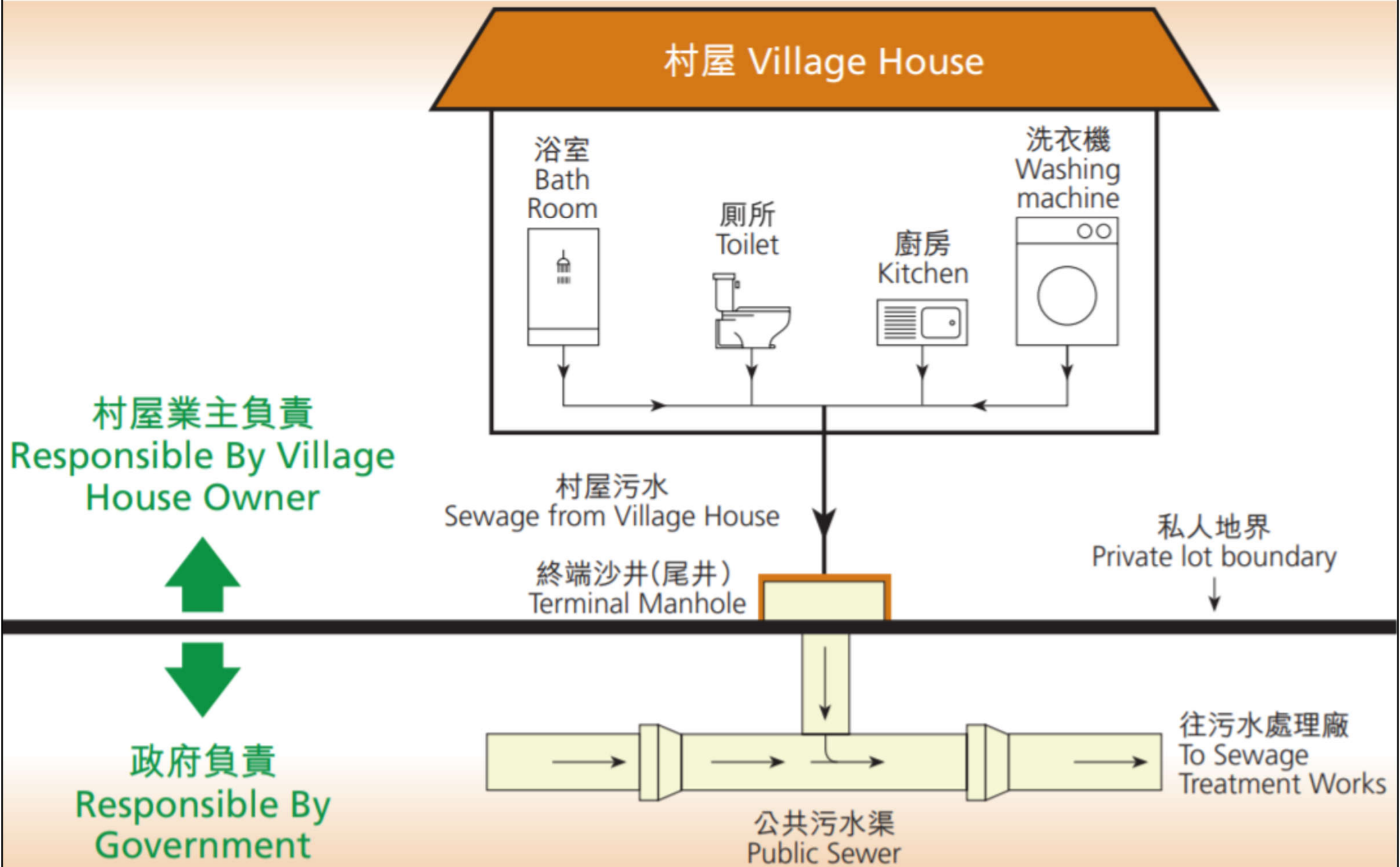

Methods of sewage disposal

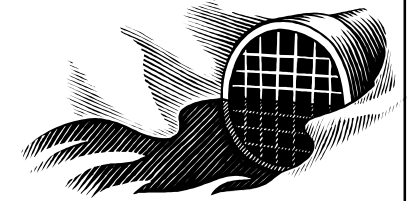

- Guidelines from the Environmental Protection Department (EPD) <https://www.epd.gov.hk/>
- Guidance Notes on Discharges from Village Houses
 - https://www.epd.gov.hk/epd/english/environmentinhk/water/guide_ref/guide_wpc_dv.html
- Guidelines for the Design of Small Sewage Treatment Plants (up to 2,000 population)
 - https://www.epd.gov.hk/epd/english/environmentinhk/water/guide_ref/guide_wpc_stp.html
- Guidelines for Estimating Sewage Flows for Sewage Infrastructure Planning (Version 1.0)
 - https://www.epd.gov.hk/epd/english/environmentinhk/water/guide_ref/gesf.html

Methods of sewage disposal



- Disposal of stormwater or rainwater
 - Sewer: combined or a separate surface-water
 - Interceptors required for car parks and kitchens
 - Soakaway: ground permeability
 - Using perforated precast concrete, dry stone or brick pit
 - Storage (see Drainage Services Dept.'s example)
 - Artificial pond or lake, or underground storage tank
 - Watercourse
 - Expected flow rates at normal and flood levels

Siting of a soakaway

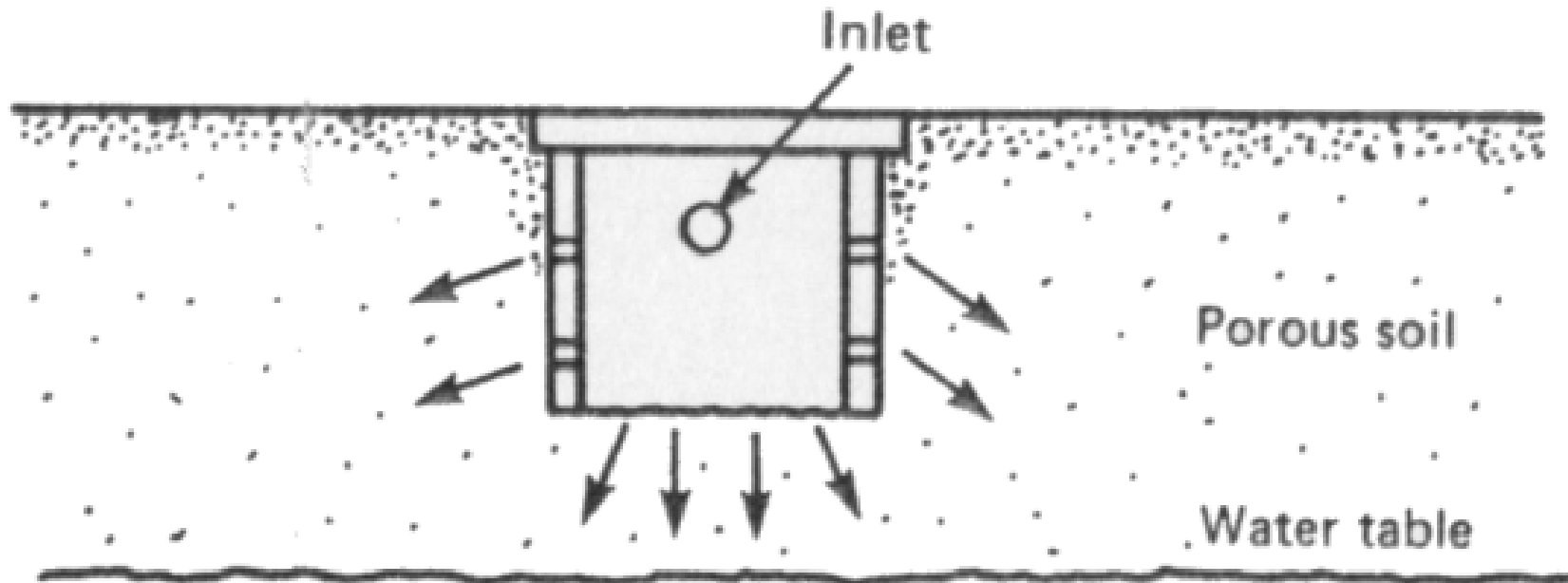

(a) Section

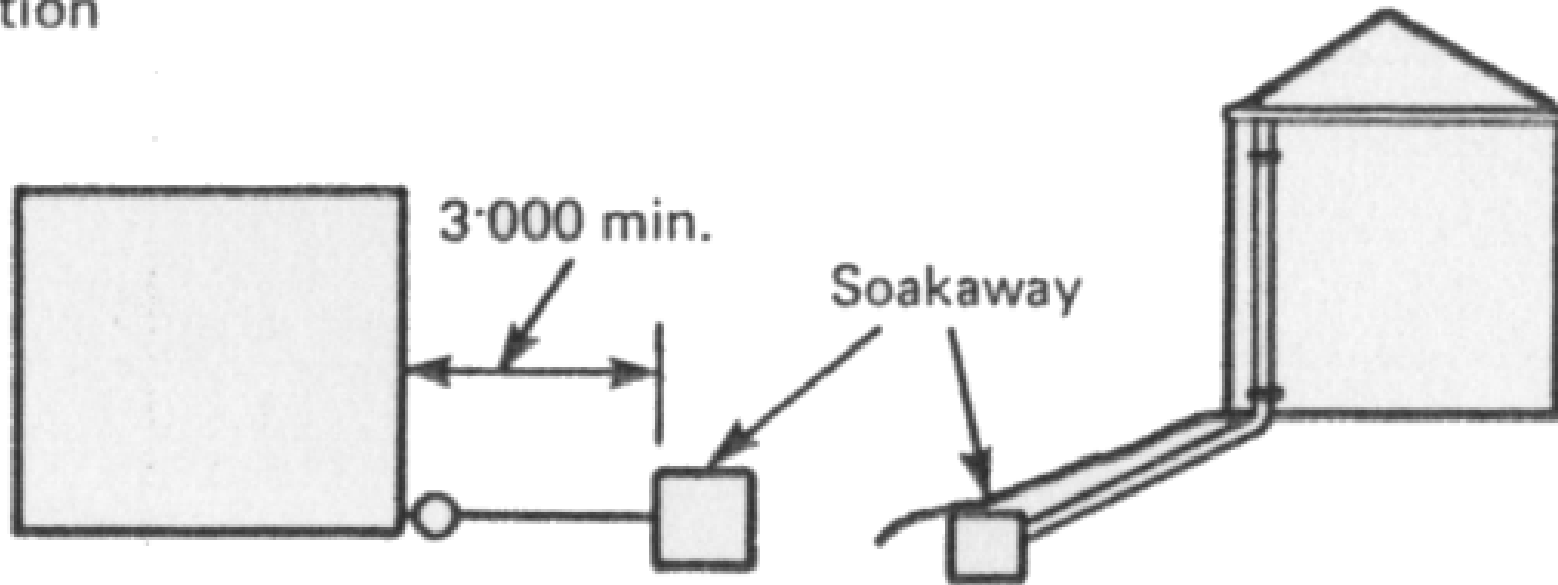

(b) Plan

(c) Best position for a soakaway

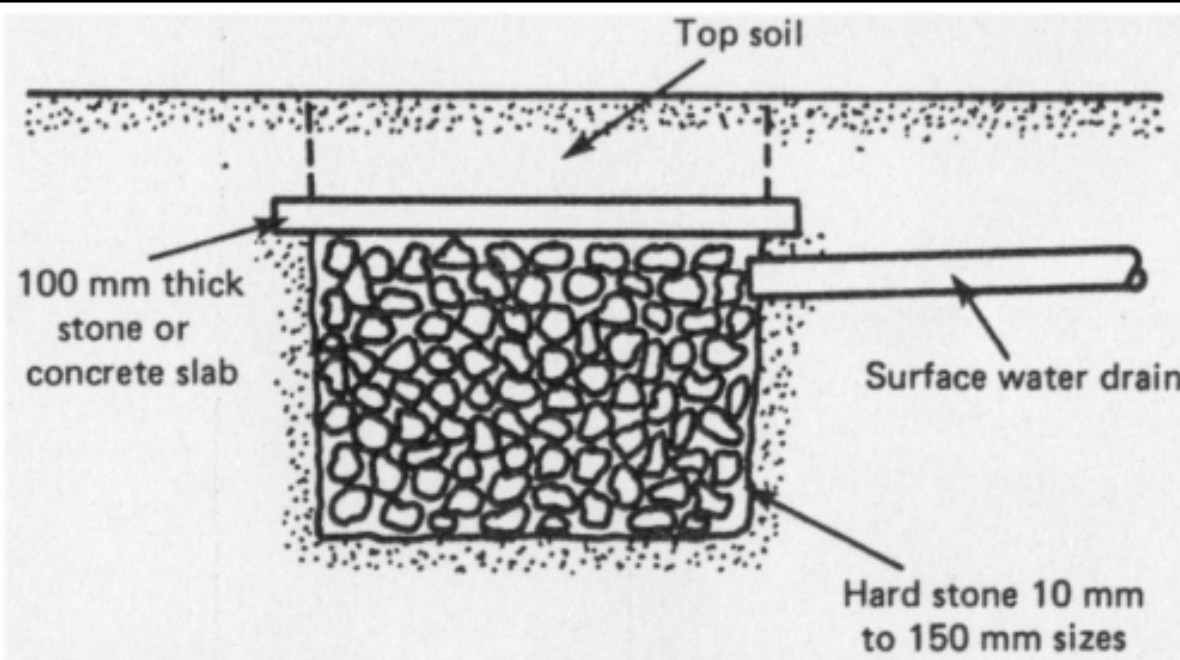

Filled soakaway

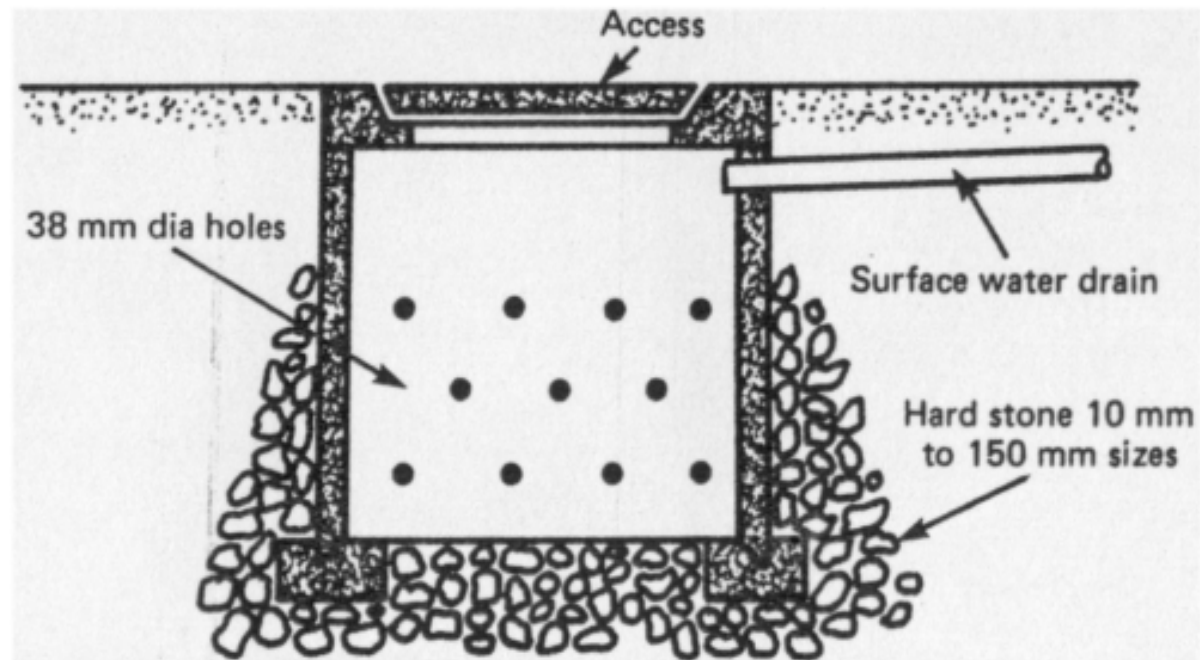

Precast concrete soakaway

Methods of sewage disposal



- Public sewers
 - If they are within 30 m of the site boundary, connection should be made
 - If they are further away, additional pipework will be required (the authority may bear the cost)
 - In Hong Kong, either the Government bears this cost or a local sewage treatment is required
- Three disposal methods if no public sewers:
 - Dilution
 - Conservancy
 - Treatment

Methods of sewage disposal



- Basic design parameters
 - Flow rate, (litre/head/day)
 - Load: Biochemical oxygen demand (BOD) (mg O₂/litre) and total suspended solids (SS) (mg/litre)
- Dilution
 - With large amount of water
 - Oxidation of the organic matter by the oxygen dissolved in the water
 - Not appropriate for large demand
 - Civil work can be very expensive

Methods of sewage disposal



- Conservancy

- Retained on the site & periodically removed
- In temporary buildings, use chemical closets
 - Portable types, used in camping sites and aircraft
 - As fixed types incorporating an underground storage tank in schools, factories and dwellings in rural areas
 - The sterilising fluid breaks down the solids of sewage
 - Smells control - a deodorising agent with the chemical, or by an oil film which seals off the surface

Chemical closets (化學處理廁所)

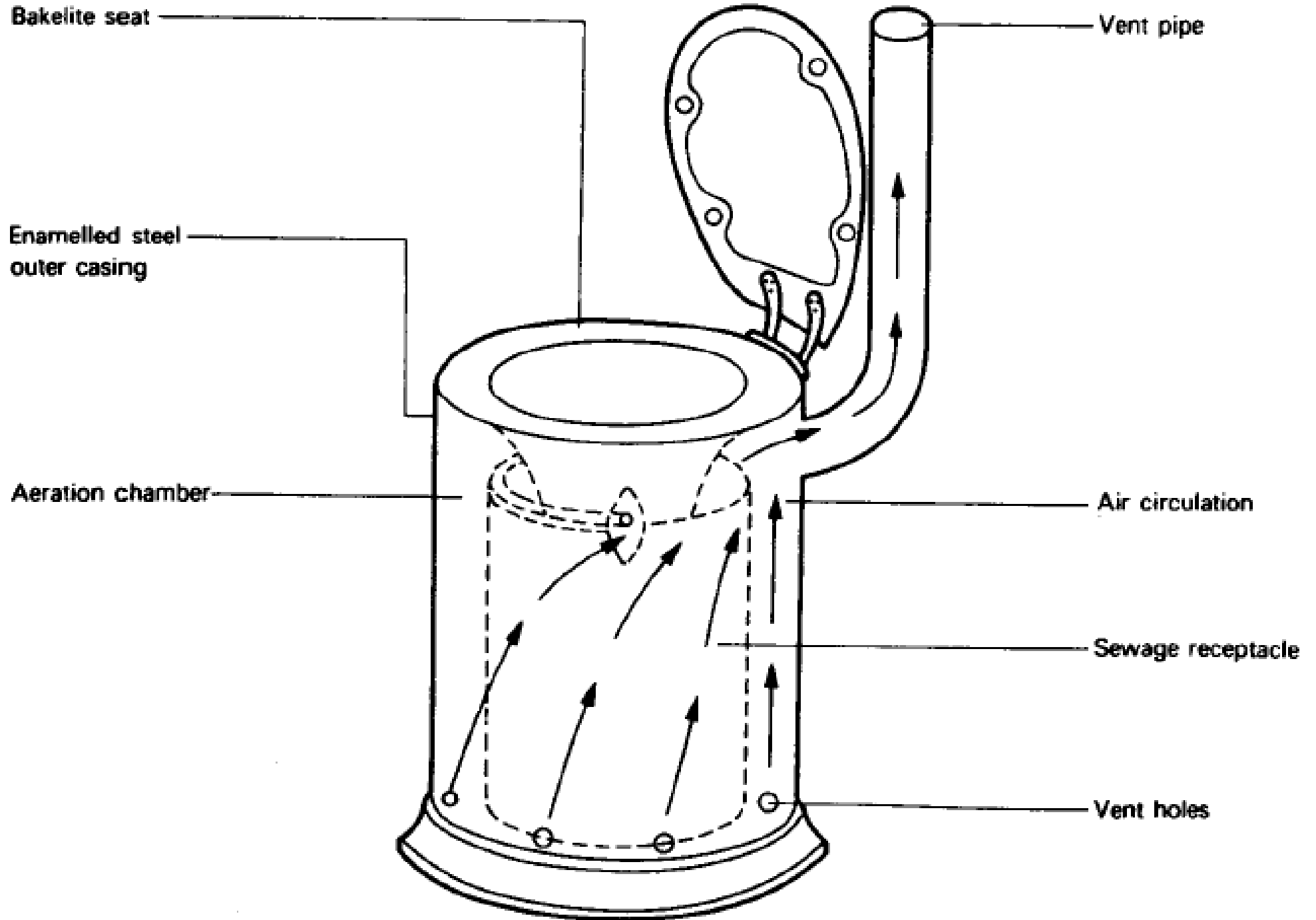

Methods of sewage disposal



- Conservancy (cont'd)

- In other buildings, use cesspools (污水池) to receive & store the flow from drains
 - For temporary buildings or permanent buildings not served by sewers
 - Be watertight & ventilated (usually underground)
 - Pump-out from cesspools at intervals
 - Access road for cleaning & emptying is required
 - Cesspool capacity: (based on UK practice)
 - Often based on a 45-day flow; about 18-45 m³
 - For dwelling, 0.11-0.14 m³ per day per person

Two types of cesspools (污水池)

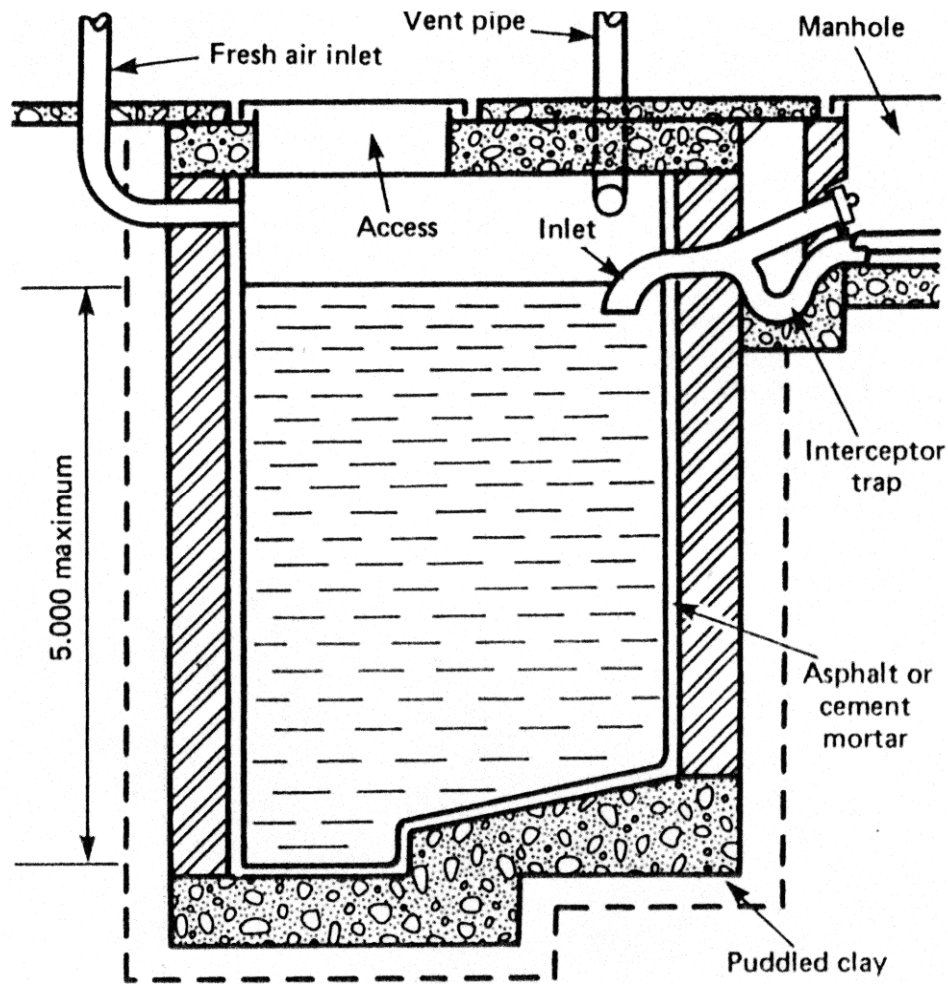

Brick cesspool

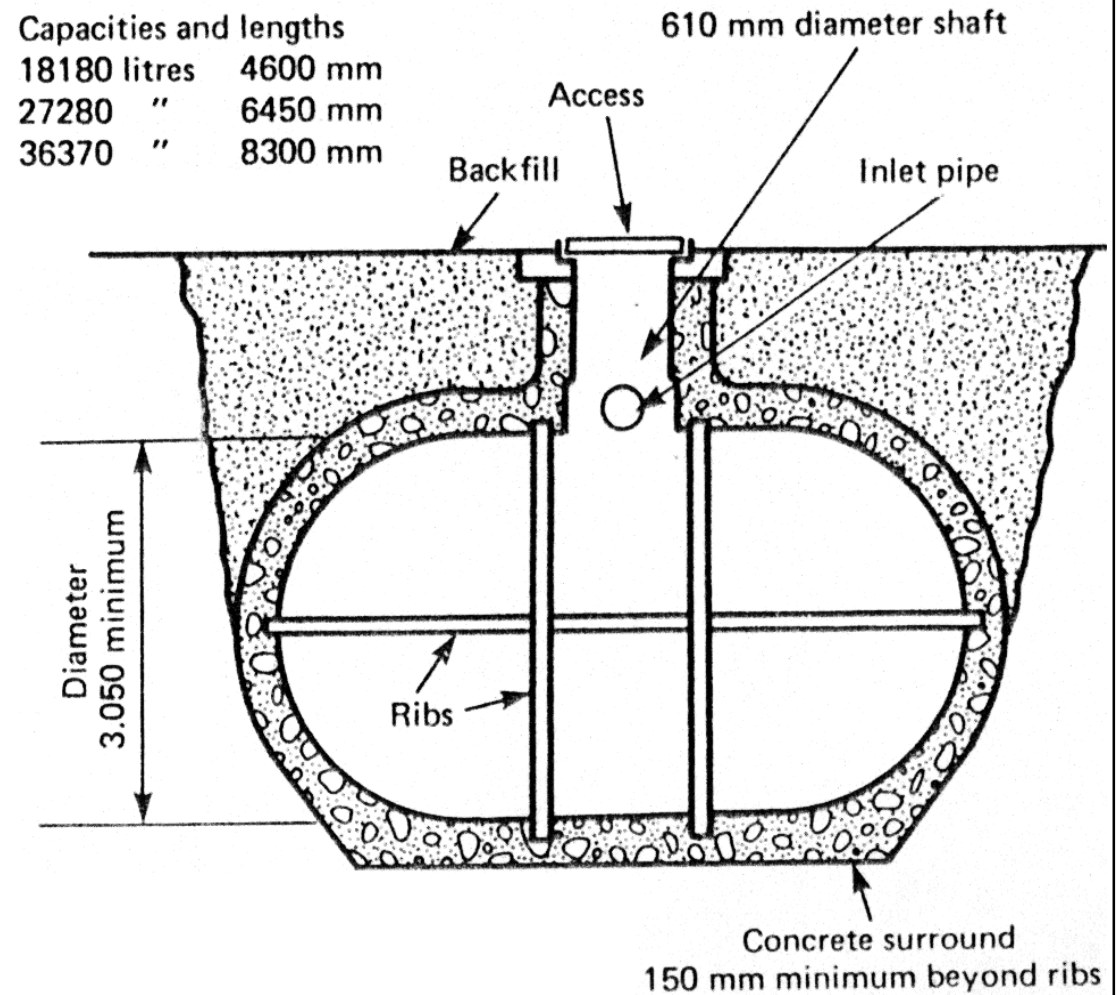

Glass reinforced polyester cesspool

Methods of sewage disposal



- Conservancy using cesspools in HK
 - Statutory requirements
 - Location: Not situated within 20 m of any spring, stream of water or well, the water source for drinking or domestic purposes and for preparation of food/ drink for human consumption, etc
 - Disposal of contents: With adequate means for removal of its content without carrying through any building in which any person resides or works

Methods of sewage disposal



- Conservancy using cesspools in HK (cont'd)
 - Statutory requirements: Capacity
 - Minimum capacity determined by Building Authority
 - Capable of storing the quantity of soil and waste discharged during a period of a month
 - Soil and waste discharged is designed at 135 litres per day per person who uses soil/waste fittings
 - Building Authority to determine the number of persons using soil or waste fitting

Methods of sewage disposal



- Conservancy using cesspools in HK (cont'd)
 - Statutory requirements: Construction
 - Construct of brickwork in cement mortar/concrete/other approved material
 - Impervious (inside or outside)
 - Reinforced concrete cover
 - With access for cleaning
 - Adequately ventilated
 - Internal faces rendered with cement mortar

Methods of sewage disposal



- Treatment

- Sewage treatment plant to make the effluent sufficiently innocuous (harmless) before discharge to stream/soil
- Process – (1) settling (2) oxidization (3) discharge
- Alternatives
 - a) Septic tank + Soakaway
 - b) Septic tank + Biological filter + Humus tank
 - c) Package sewage treatment plant
 - d) (Large scale) sewage treatment plant

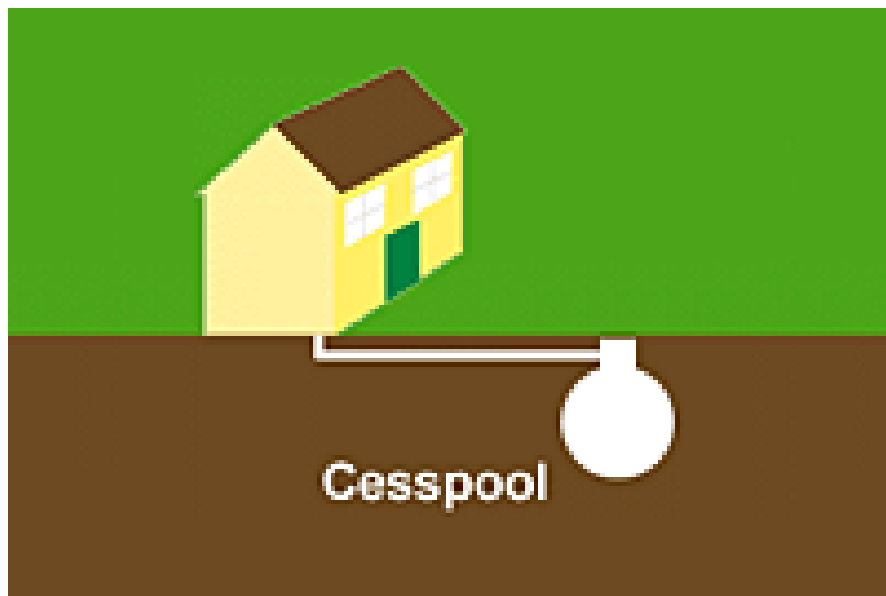

Using cesspool

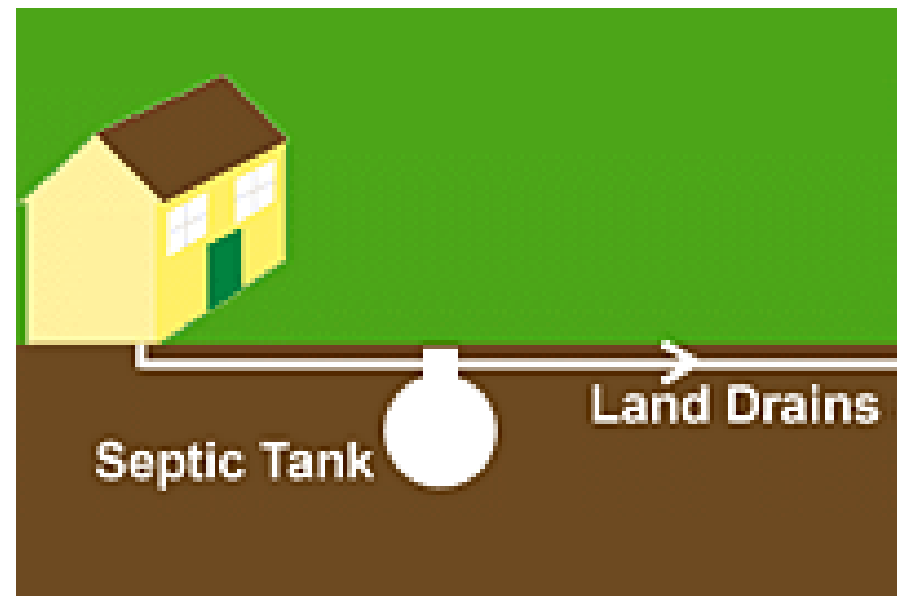

Using septic tank

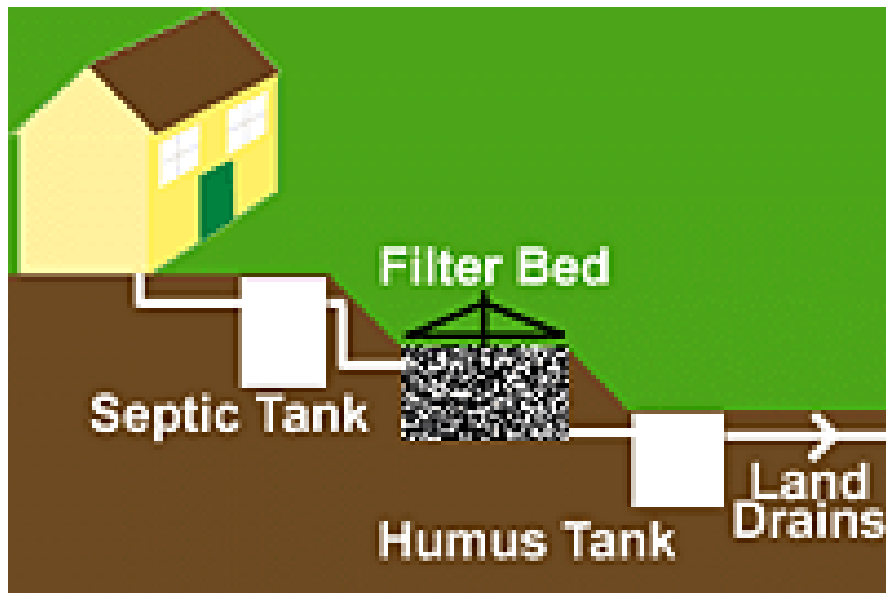

Sewage treatment plant
with filter bed

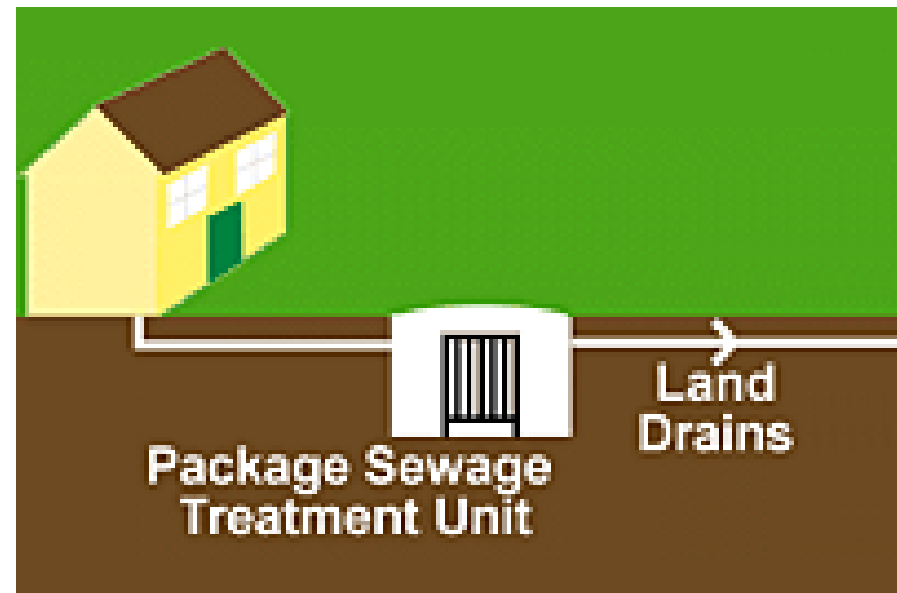

Package sewage treatment unit

Methods of sewage disposal



- Treatment (cont'd)

- Choice:

- Small sewage treatment plant or
- Septic tank + soakaway

- Use septic tank + soakaway for

- Small development with a population of less than 50
- Site percolation test find it viable and no adverse conditions exist

Methods of sewage disposal

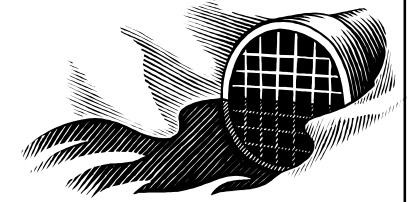

- Septic tank (化糞池)

- Effect on sewage

- ‘Scum’ on the top
- ‘Liquor’ in middle
- ‘Sludge’ at bottom

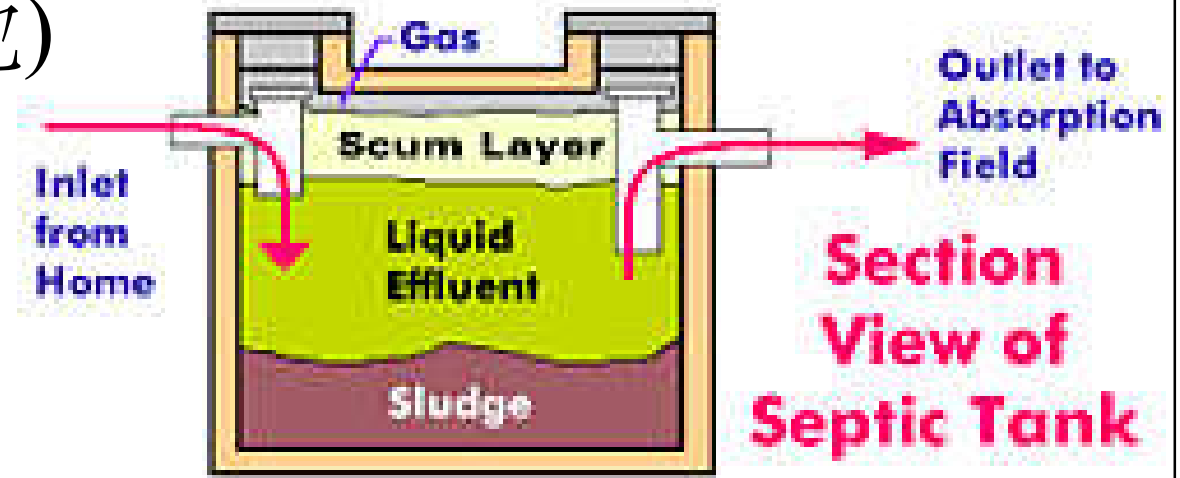

- Break down organic content by anaerobic bacteria (no oxygen); reduce sludge quantity & odours

- The process can take 2 months or more
- In large plant, sludge gas can be used for power/heating

Methods of sewage disposal



- Septic tank (cont'd)
 - Capacity: 16-48 hours flow; min. 3.5 m³
 - Suitable dimensions
 - Content not disturbed by any entering flows
 - Contain the accumulation of sludge
 - Volume of sludge = 0.8 litres per person per day
 - Materials: concrete is most common
 - Single or multiple chambers can be used

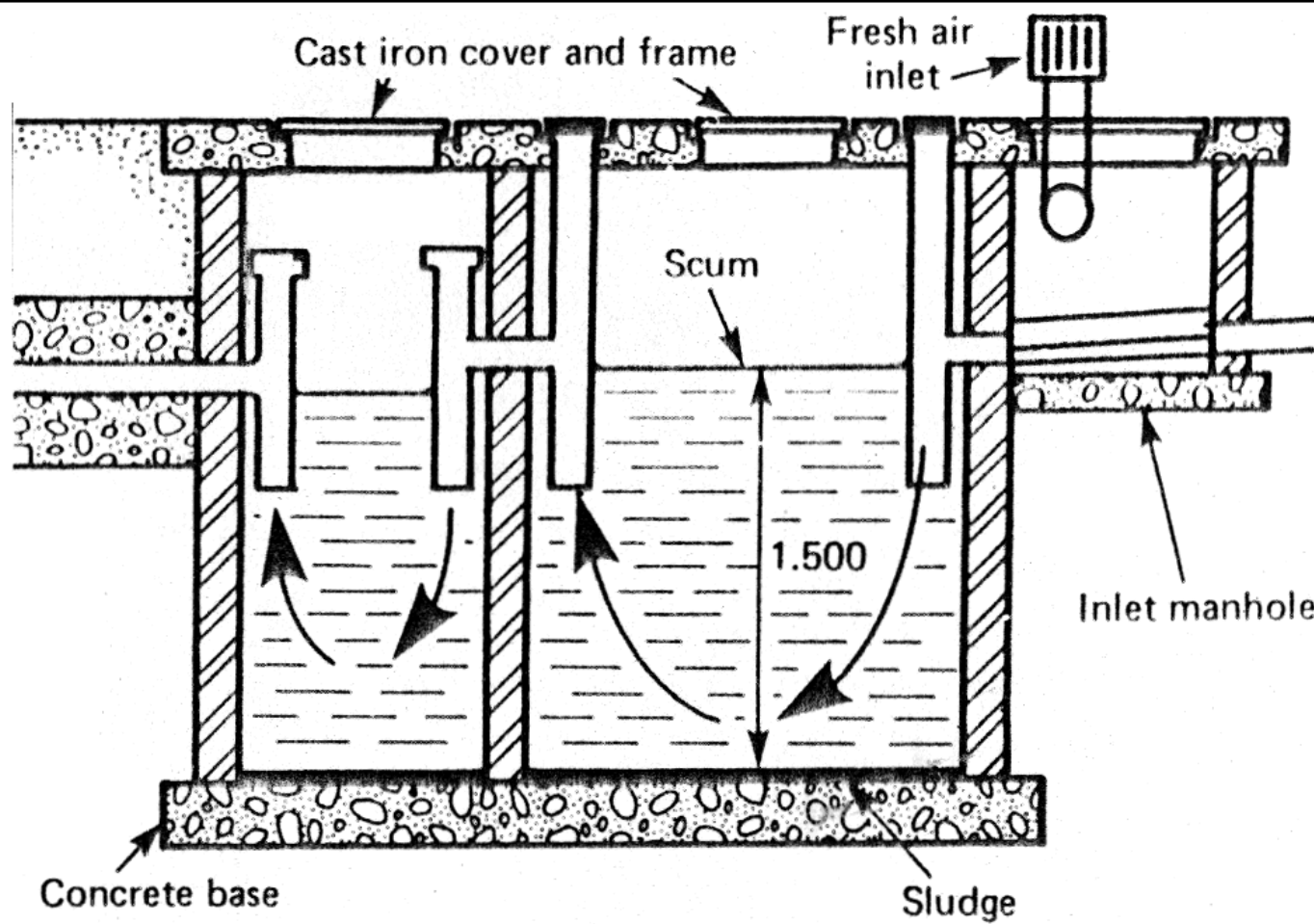

Septic tank design

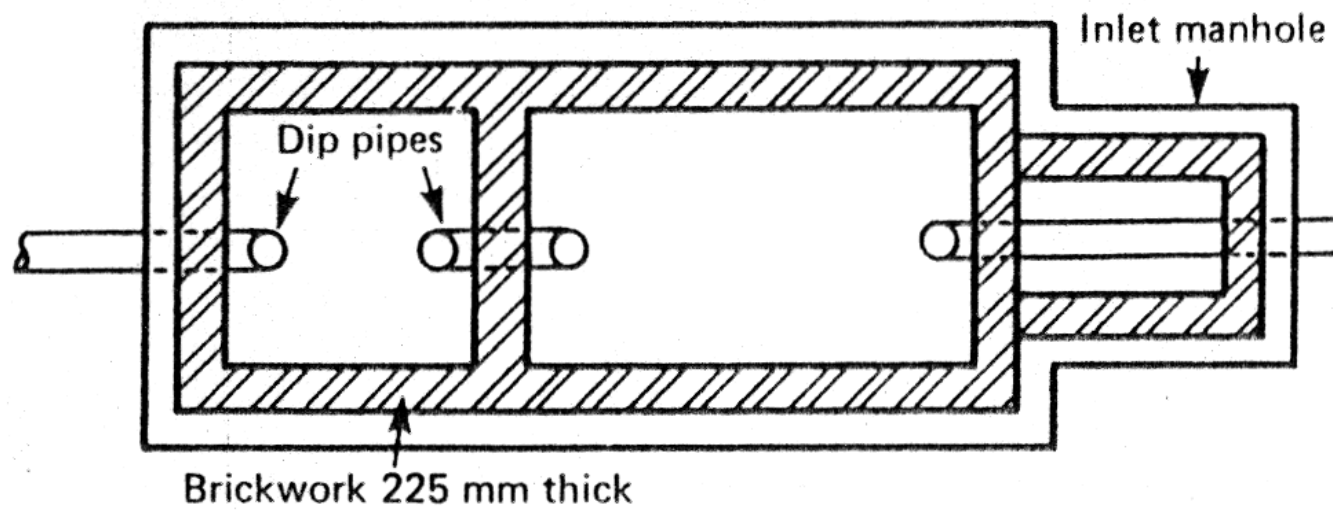

Site plan of septic tank installation

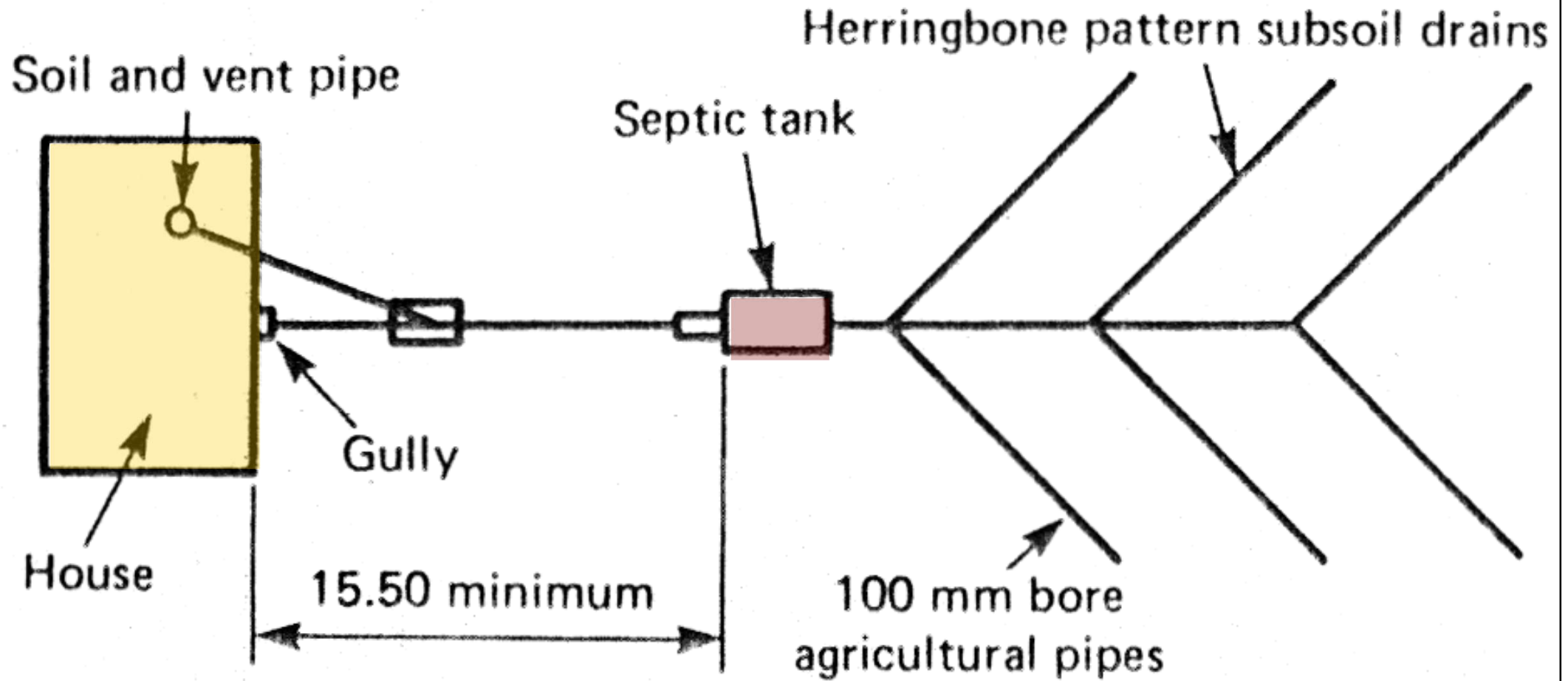

Methods of sewage disposal



- Septic tank – statutory requirements in HK
 - Situation of septic tank
 - At a minimum of 18m away from stream of water or well, water source for drinking, domestic purposes, food preparation or manufacturing factory, etc
 - Disposal of effluent
 - Building owner who is about to install septic tank shall submit to the Building Authority for approval on method of disposal of effluent and sludge
 - Criteria – neither nuisance nor injury to health

Methods of sewage disposal



- Septic tank – statutory req's in HK (cont'd)
 - Capacity
 - Volume = 2.3 m³ to 41 m³
 - Store soil and waste for one day
 - Calculate soil and waste discharge based on the rate of consumption of potable and flushing water
 - Construction
 - Depth between 1.2m to 1.8m
 - Length = 3 to 4 times of width
 - Adequate means of access for inspection and cleaning

Methods of sewage disposal



- Septic tank – statutory req's in HK (cont'd)
 - Construction
 - Sides of the tank constructed with brickwork in cement mortar min. 215 mm thick or concrete min 125 mm thick, or other approved materials
 - Maintenance
 - Inspect and desludge at least once every 6 months
 - Prevent flooding and overflow
 - Control foul smell

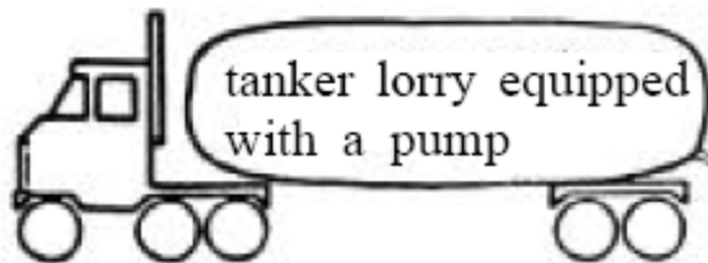

tanker lorry equipped with a pump

OR



tank mounted on lorry

Pump out the content of the septic tank and any settled sludge in the soakaway pit into a tanker lorry. This is usually done by a specialist contractor.

Septic tank

Soakaway

A septic tank should not be completely cleaned. A thin layer (approx. 1 cm) of old sludge should be left at the bottom to maintain the efficiency of the septic tank after desludging.

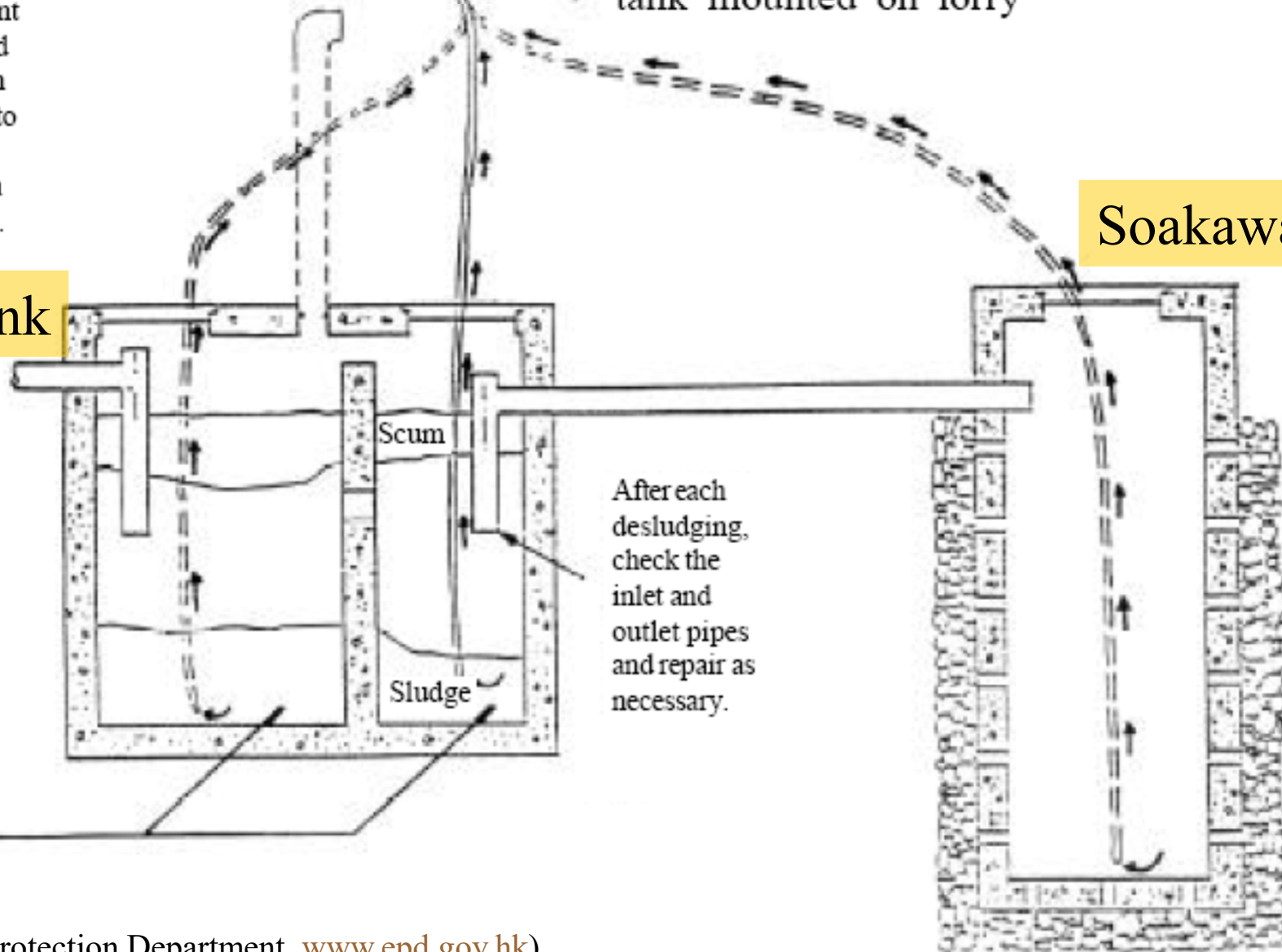

After each desludging, check the inlet and outlet pipes and repair as necessary.

Methods of sewage disposal



- Biological filter
 - Filled with porous medium, e.g. broken stone, clinker, coke or polythene shingle
 - Surfaces of the medium become coated with an organic film
 - 'Aerobic' bacteria oxidize the polluting matter
 - Ventilation/oxygen is required (such as by under-drains + vertical vent pipes)

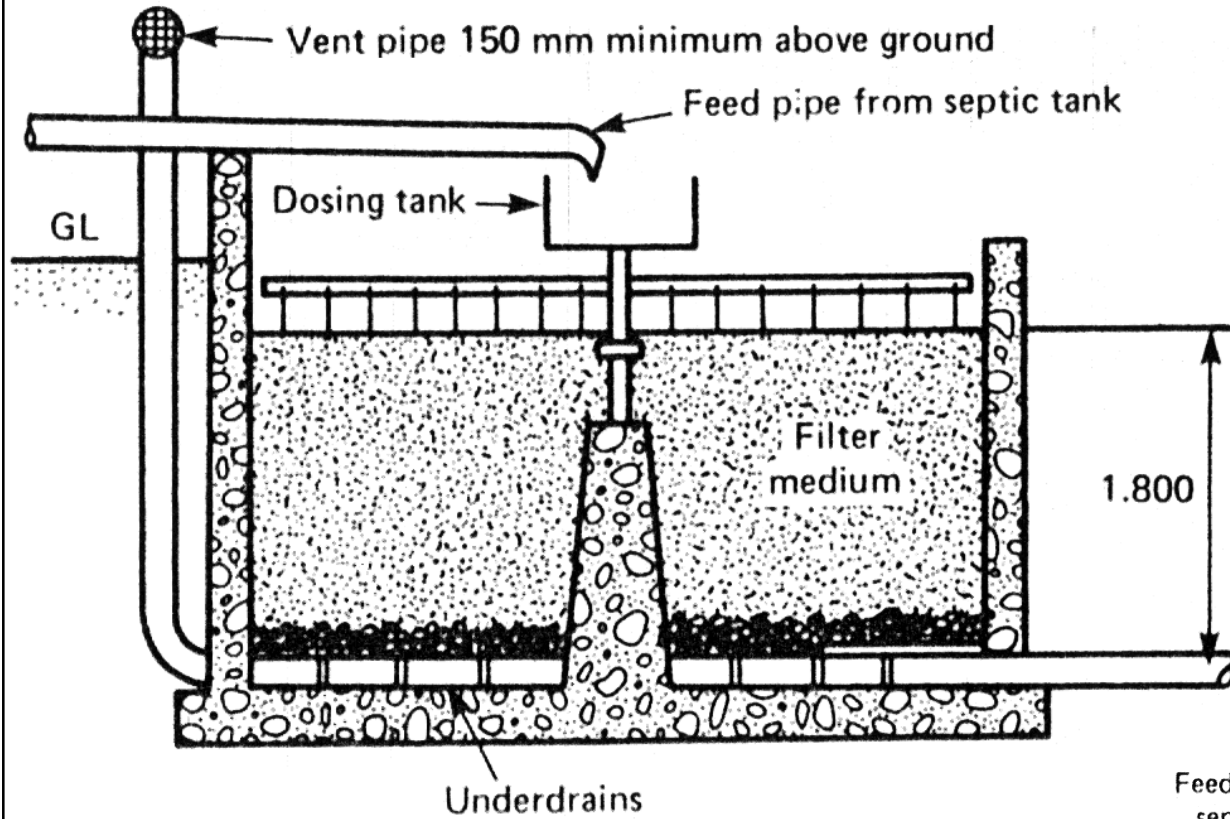

Biological filter

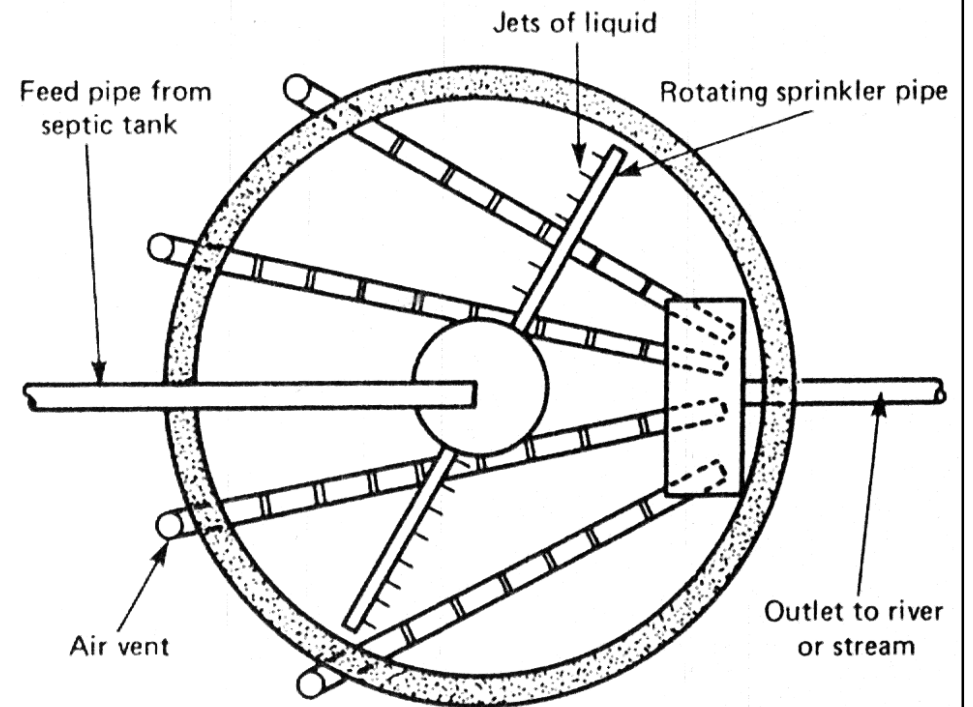

Volume of filter
 For up to 10 persons – 1 m³/person
 From 10–50 persons – 0.8 m³/person
 Over 50–300 persons – 0.6 m³/person

(Source: Hall, F. and Greeno, R., 2008. *Building Services Handbook*)

Methods of sewage disposal



- Settlement tank
 - For example, the Klargestor settlement tank
 - In glass reinforced plastic
 - Simple, reliable & cost effective for small systems
 - Capacities 2,700-100,000 litres
 - Three separate chambers
 - Sludge must be removed every 12 months

Klargester settlement tank

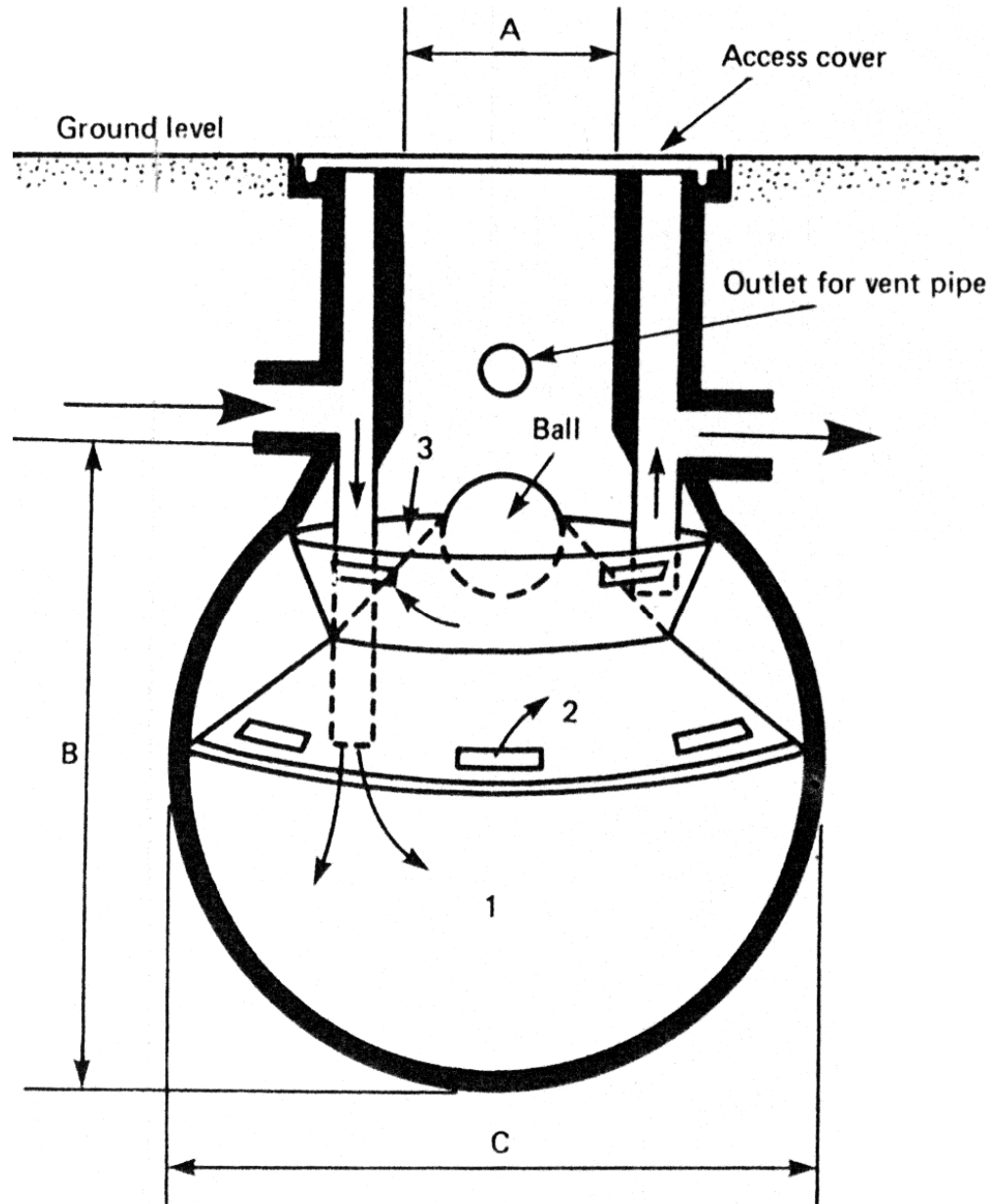

Details of Klargester tank

Capacity of tank in litres	Number of users with flow rate per head per day		Nominal dimensions in mm.		
	180 litres	250 litres	A	B	C
2700	4	3	610	1850	1800
3750	9	7	610	2060	2000
4500	14	10	610	2150	2100
6000	22	16	610	2400	2300
7500	30	22	610	2630	2500
10000	44	32	610	2800	2740

Note: The floating ball will push away to give access into the lowest chamber for sludge removal

Methods of sewage disposal

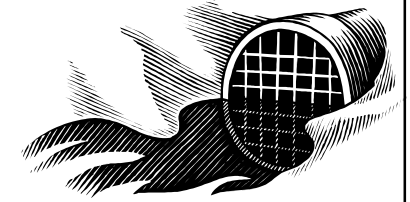

- ‘Packaged’ sewage treatment plant
 - For example, the biodisc treatment plant

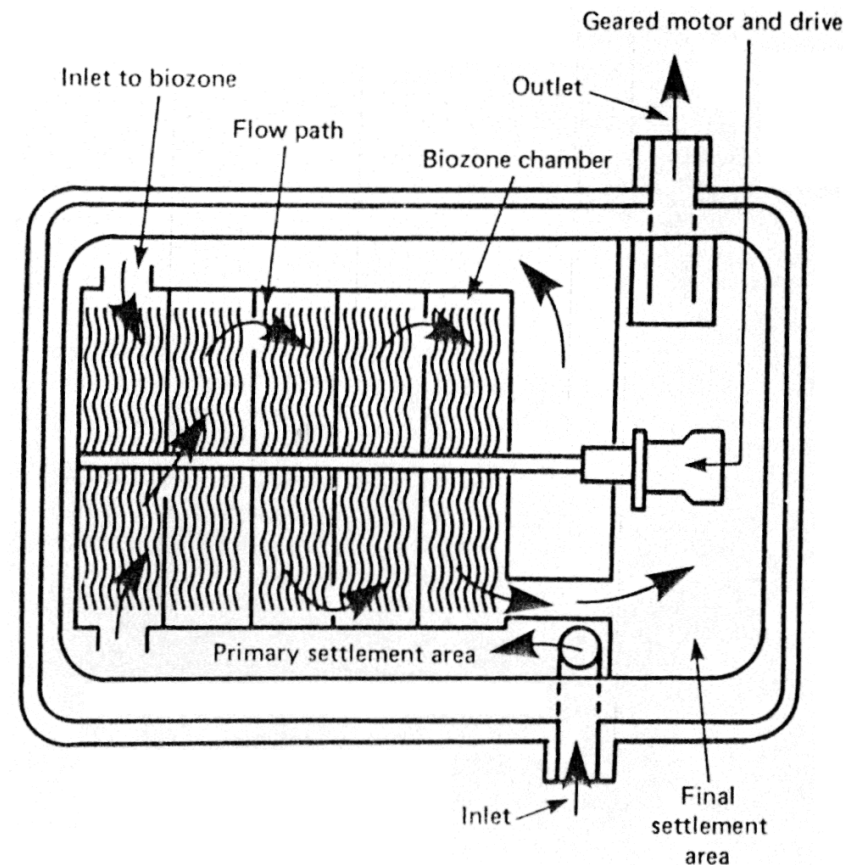
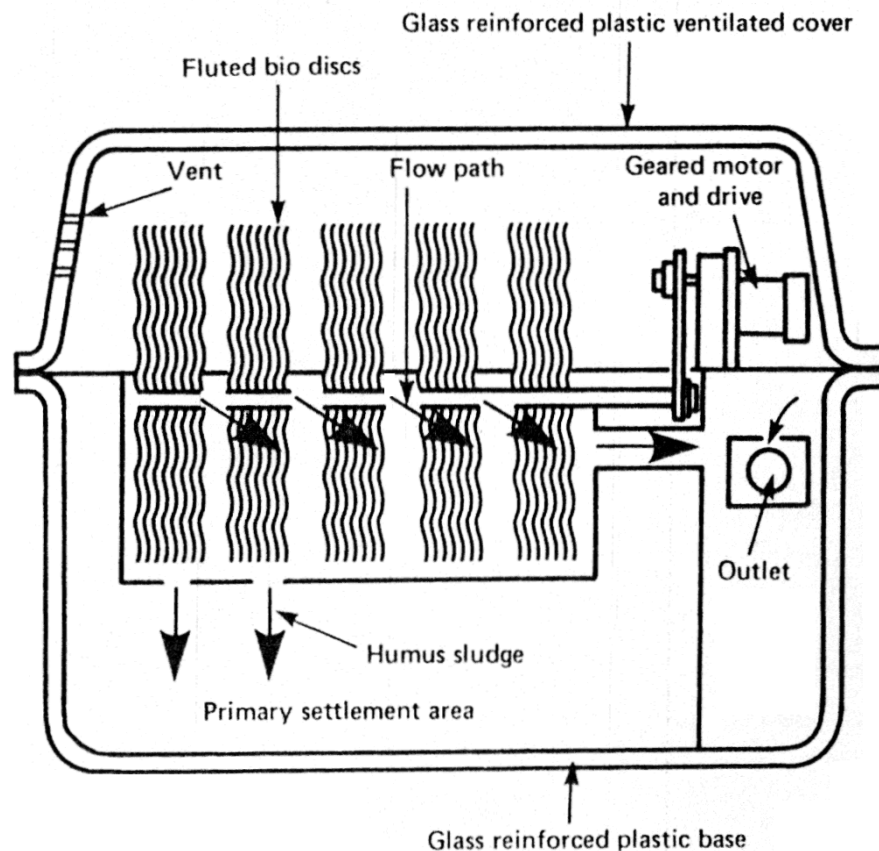

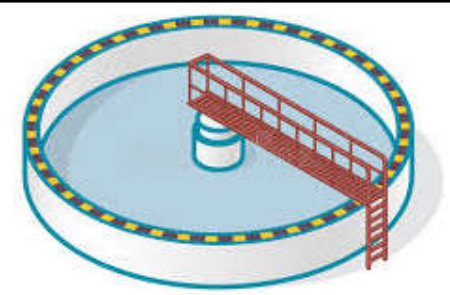

Sewage treatment process

- Sewerage in Hong Kong
 - Everyday, we produce 2.8 million m³ of sewage, enough to fill up over 1,500 Olympic-size swimming pools
 - About 93.7% of the population are now served by the public sewerage system with over 98% of the sewage produced being collected and treated
 - A sewerage network of over 1,900 km in total length and around 324 plants treating sewage prior to disposal to the sea for dilution and dispersion through submarine outfalls

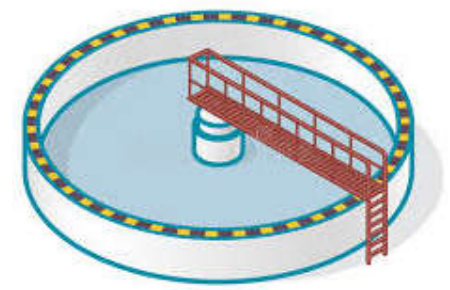

Sewage treatment process

- Drainage Services Department (DSD) 渠務署

<http://www.dsd.gov.hk/>

- DSD Facilities Online Tour

- https://www.dsd.gov.hk/EN/Education/DSD_Facilities_Virtual_Tour/

- Flood prevention

- https://www.dsd.gov.hk/EN/CoreBusiness/Flood_Prevention/

- Polluter Pays Principle

- https://www.dsd.gov.hk/EN/Sewage_Services_Charging_Scheme/Polluter_Pays_Principle/

- Sewerage

- <https://www.dsd.gov.hk/EN/CoreBusiness/Sewerage/>

- Sewage Treatment Facilities

- https://www.dsd.gov.hk/EN/Sewerage/Sewage_Treatment_Facilities/

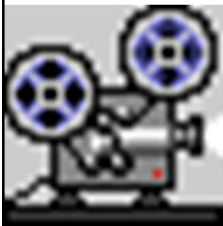

Video: DSD Corporate Video (Long Version) (7:35) <https://youtu.be/yzpXvuChkws>

Sewage treatment works in Hong Kong



(See also: DSD Facilities Online Tour https://www.dsd.gov.hk/EN/Education/DSD_Facilities_Virtual_Tour/)

Harbour Area Treatment Scheme (HATS)

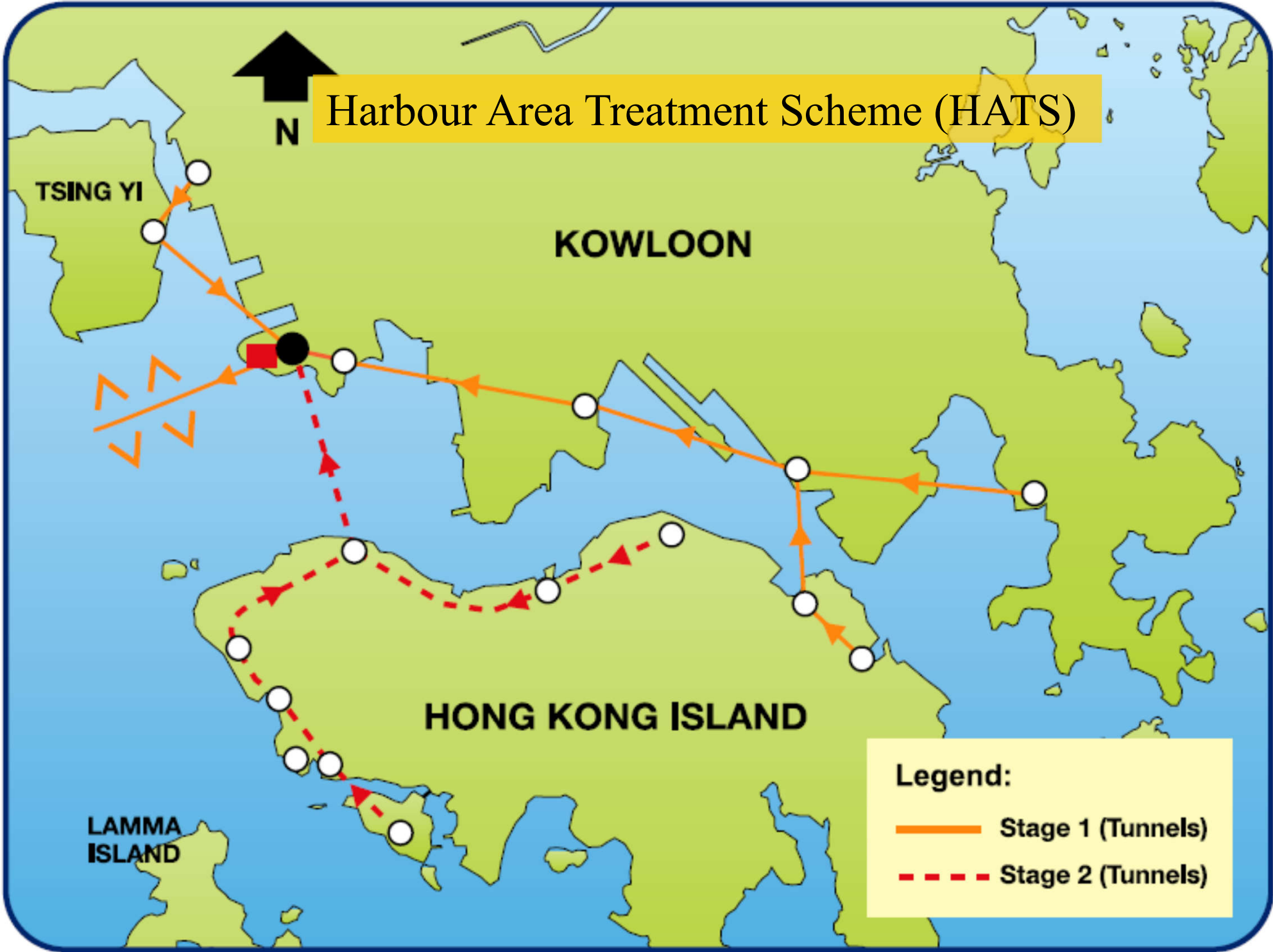

(Source: www.cleanharbour.gov.hk)

Stage I Tunnels of Strategic Sewage Disposal Scheme (SSDS)



HONG KONG STRATEGIC SEWAGE DISPOSAL SCHEME

STAGE I - PRINCIPAL COLLECTION & TREATMENT SYSTEM

Kowloon
Peninsula

Kwai
Chung &
Tsing Yi

Tseung
Kwan O

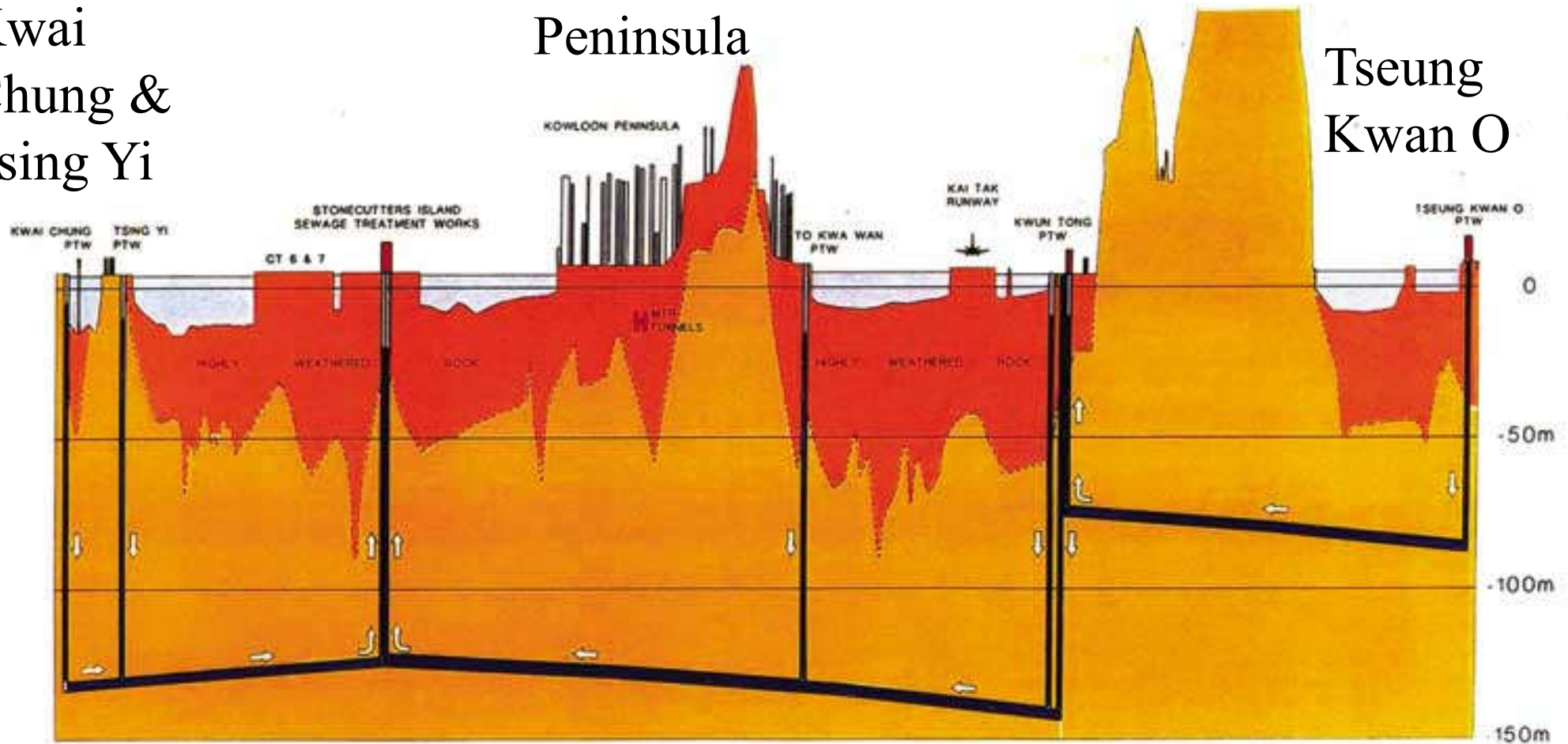

PROFILE OF DEEP TUNNEL SYSTEM

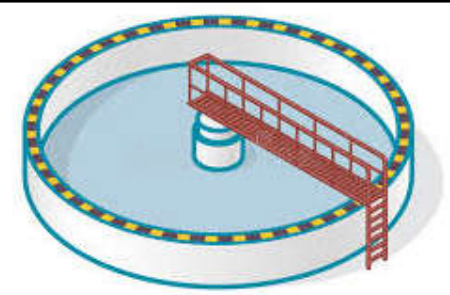

Sewage treatment process

- Sewage charge in HK
 - For 1995-2008, it is \$1.2 per m³ of water supplied
 - For each domestic account, the first 12m³ supplied in each 4 monthly consumption period is exempted
 - From 2008 to 2017, the rate started to increase incrementally, from \$1.31 to \$2.92
- Trade effluent surcharge
 - For industries or commerce where pollution level of the wastewater discharged exceeds that of domestic level

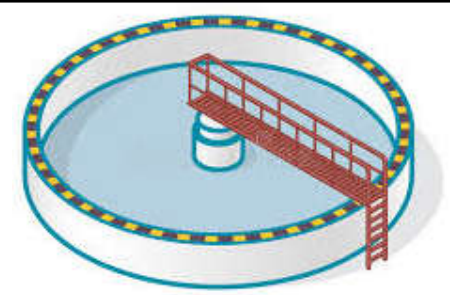

Sewage treatment process

- Sewage treatment
 - Usually done by natural or biological system
 - Can be done by chemical/electrical means (expensive)
 - Typical steps
 - Sedimentation (in septic and settlement tanks)
 - Oxidation of organic matter (using biological agencies)
 - Treated effluent is discharged to watercourse or by surface/subsurface irrigation
 - Sludge (汚泥) in tanks is removed, say, every 6 months
 - Either dumped or used as fertilizer

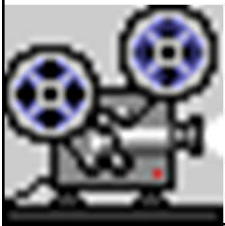

Sewage treatment process in Shatin Sewage Treatment Works

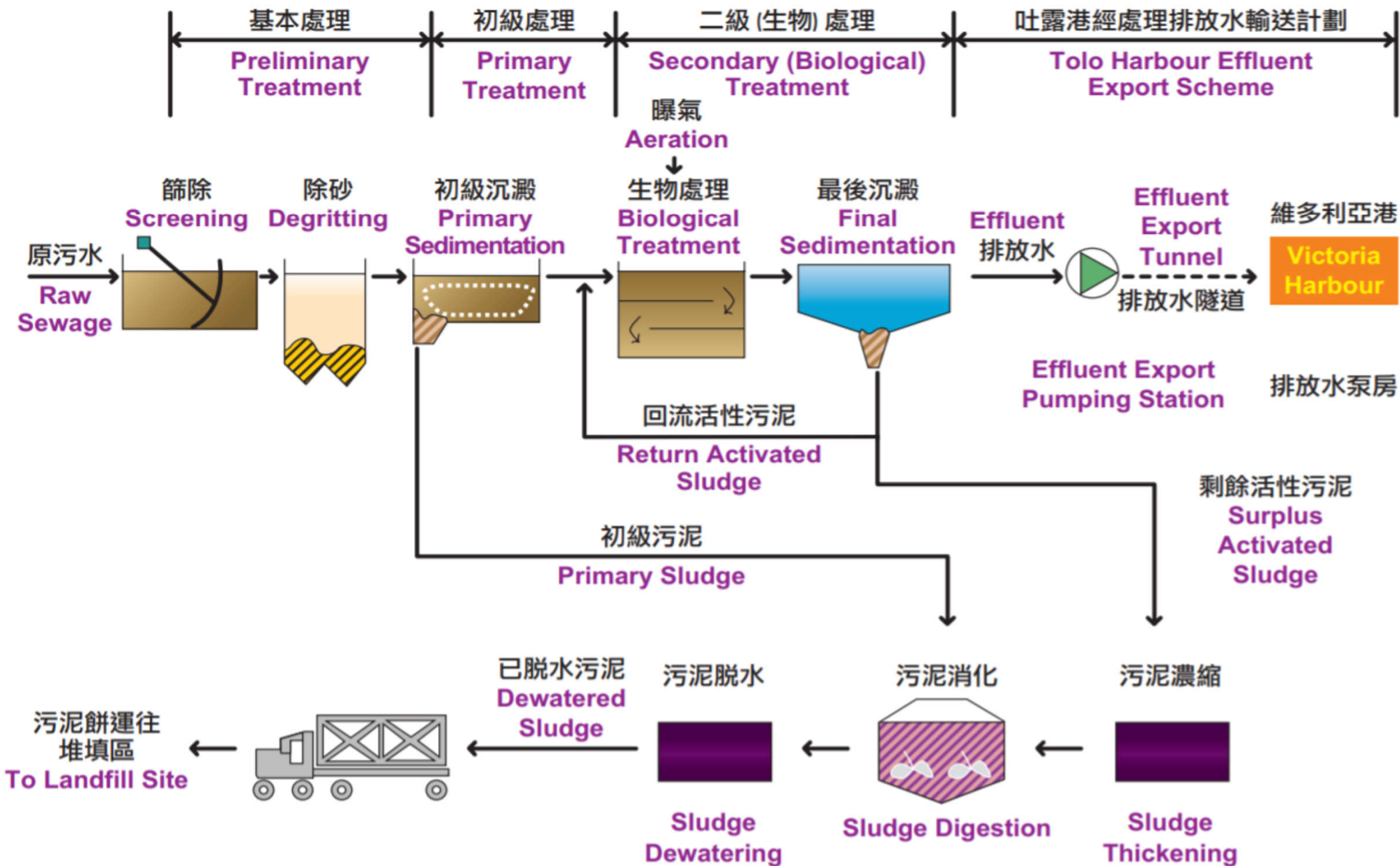

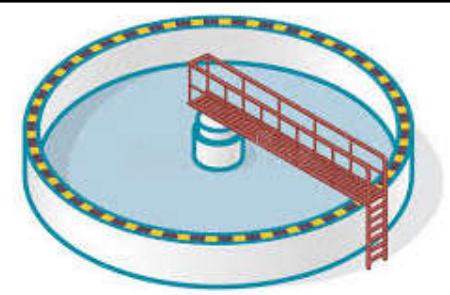

Sewage treatment process

- Sewage treatment (cont'd)
 - Activated sludge process (a biological method):
 - Performed by a variable and mixed community of microorganisms in an aerobic aquatic environment
 - These microorganisms derive energy from carbonaceous organic matter in aerated wastewater (synthesis)
 - A variable number of microorganisms in the system obtain energy by converting ammonia nitrogen to nitrate nitrogen (nitrification)
 - Anaerobic digestion:
 - It involves bacteria that thrive in the absence of oxygen
 - In this sludge process, organics are converted into carbon dioxide and methane gas

A simplified schematic diagram of an activated sludge process

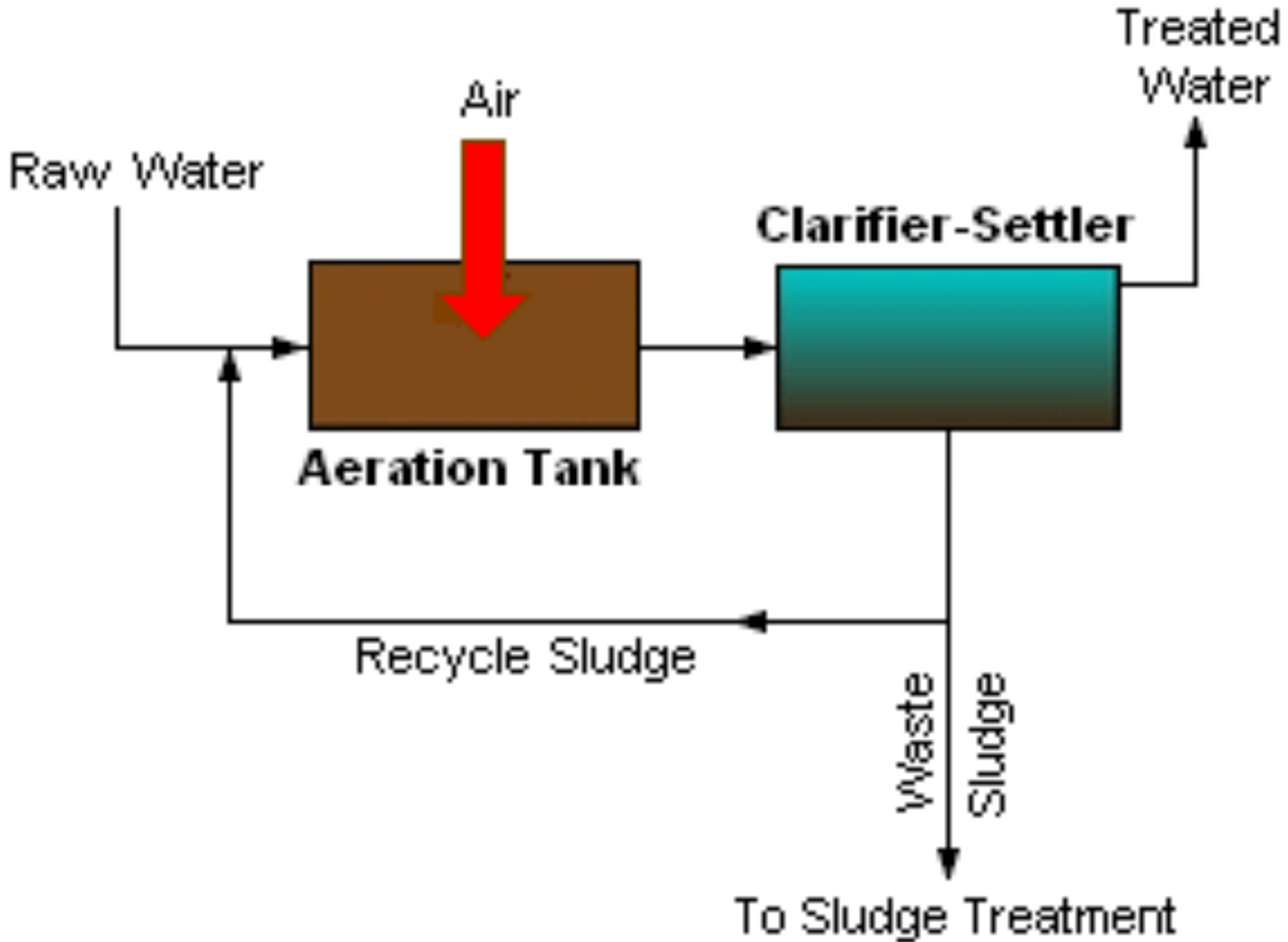

Activated Sludge Process

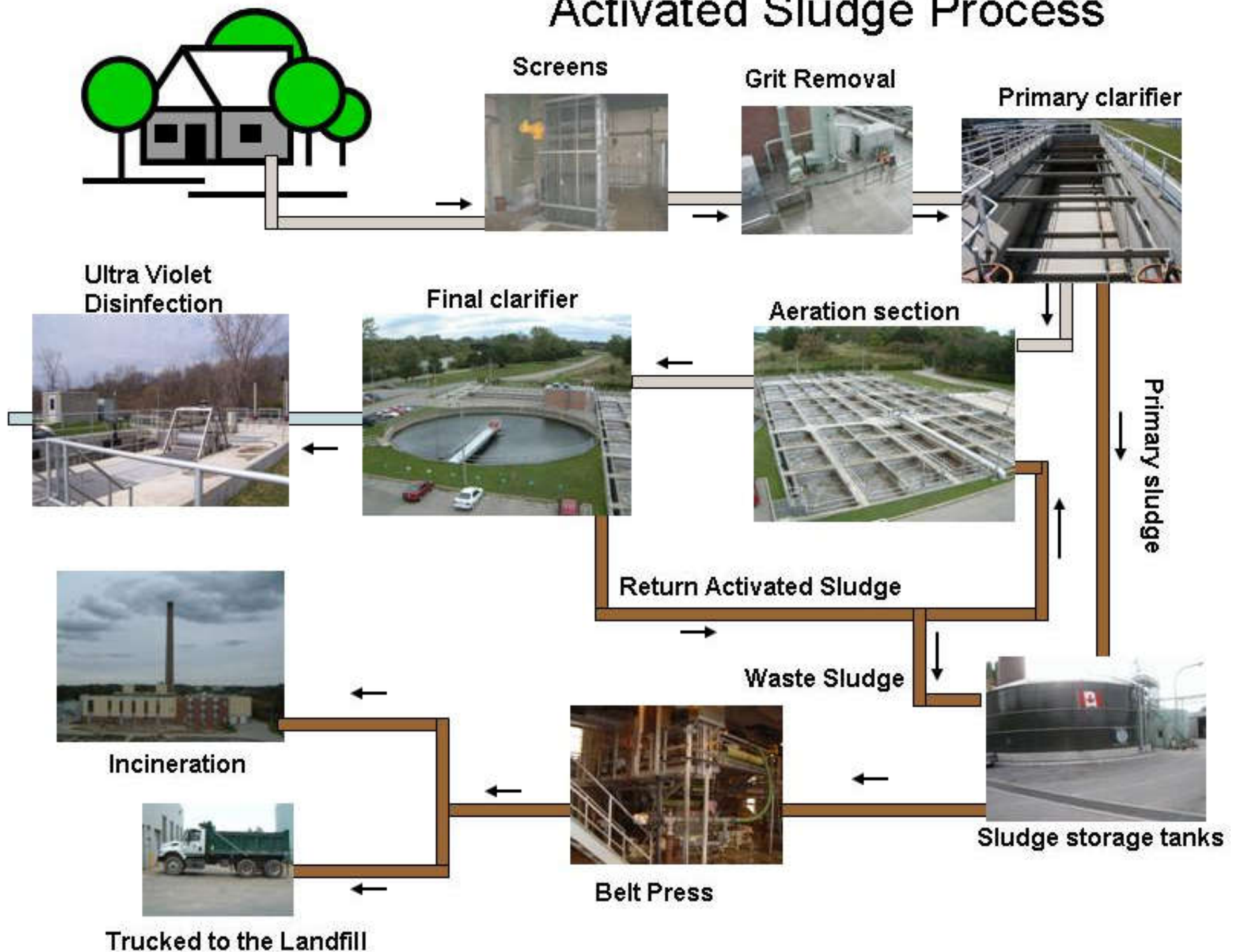

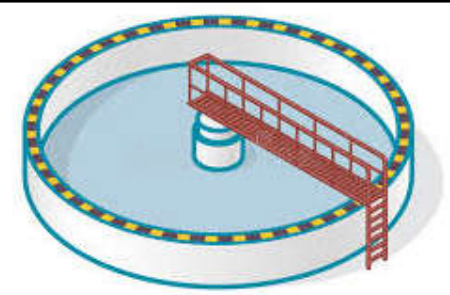

Sewage treatment process

- Main stages of sewage treatment
 - 1. Preliminary works (screens & grit channels)
 - 2. Primary settlement (settlement tanks)
 - 3. Biological treatment (in filter beds, biological contactors or activated sludge)
 - 4. Secondary settlement (humus tanks)
 - 5. Tertiary treatment (needed for high discharge standard or poor raw effluent)

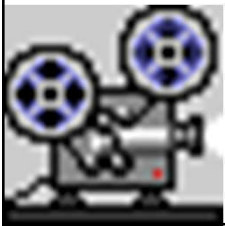

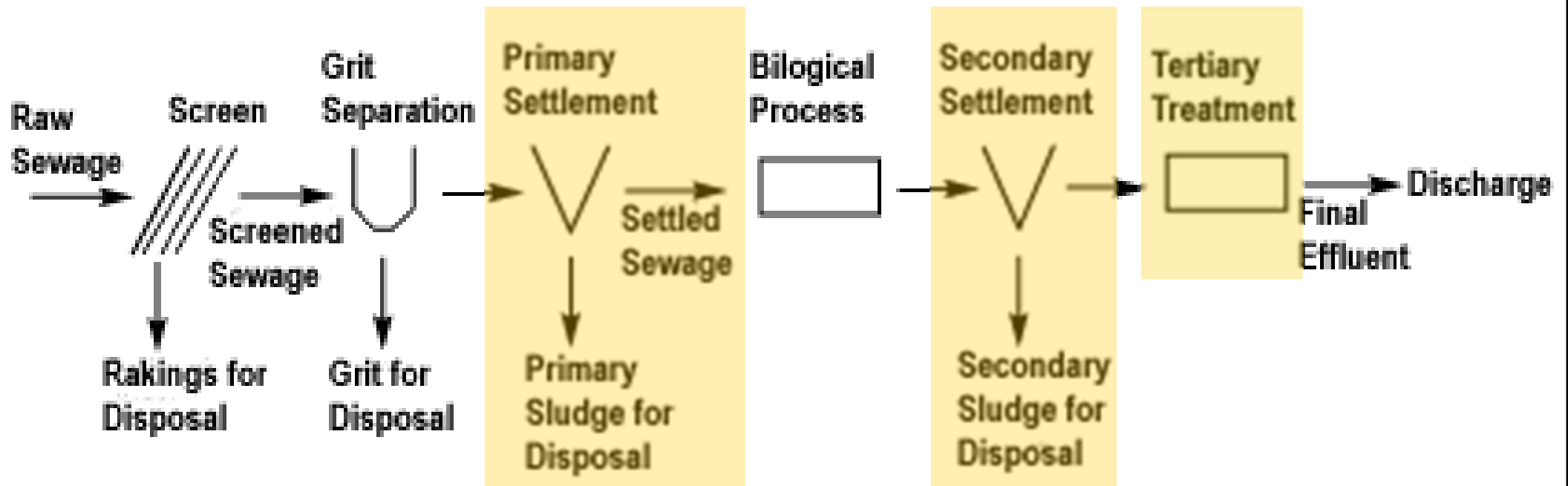

Diagrammatic representation of the process of sewage treatment

Process flow diagram for a typical sewage treatment plant

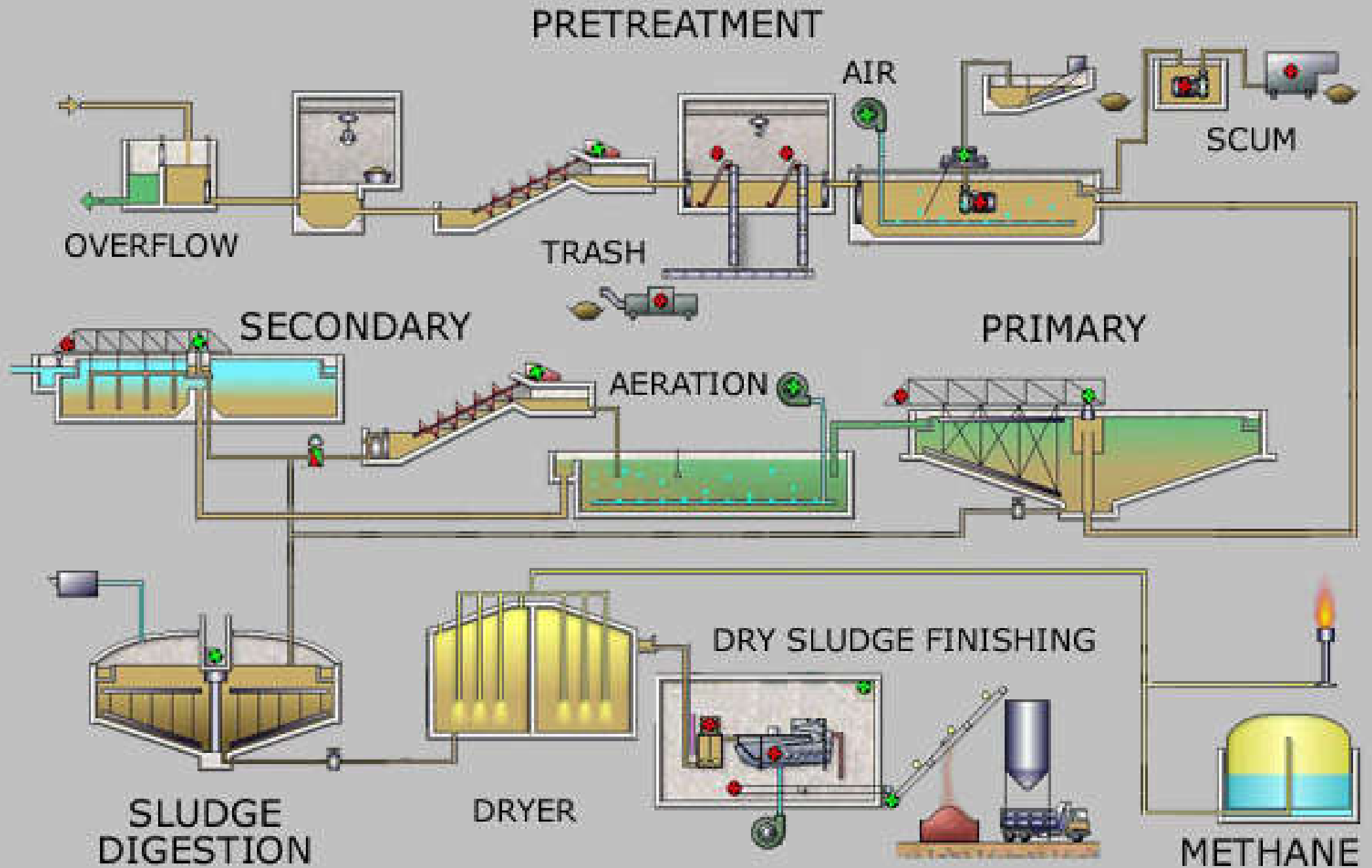

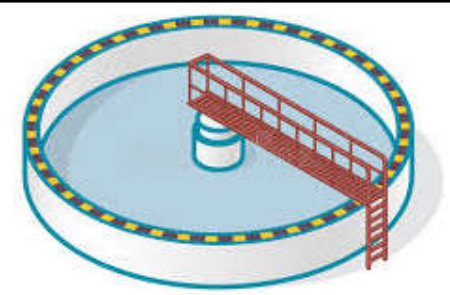

Sewage treatment process

- Types of sewage treatment facilities in HK
 - Preliminary Treatment (Screening) - includes screening and removal of grit (remove solids > 6 mm in diameter)
 - Primary Treatment - includes screening, removal of grit and a primary sedimentation process. Solid waste and settleable suspended solids are removed
 - Chemically Enhanced Primary Treatment (CEPT) - chemicals are added to enhance the removal of suspended solids and the biochemical oxygen demand
 - Secondary Treatment - the sewage is purified by means of a biological treatment process after the primary treatment has been completed. The organic matter is decomposed by micro-organisms
 - Tertiary Treatment - the highest level of treatment

Treatment process at Stanley Sewage Treatment Works

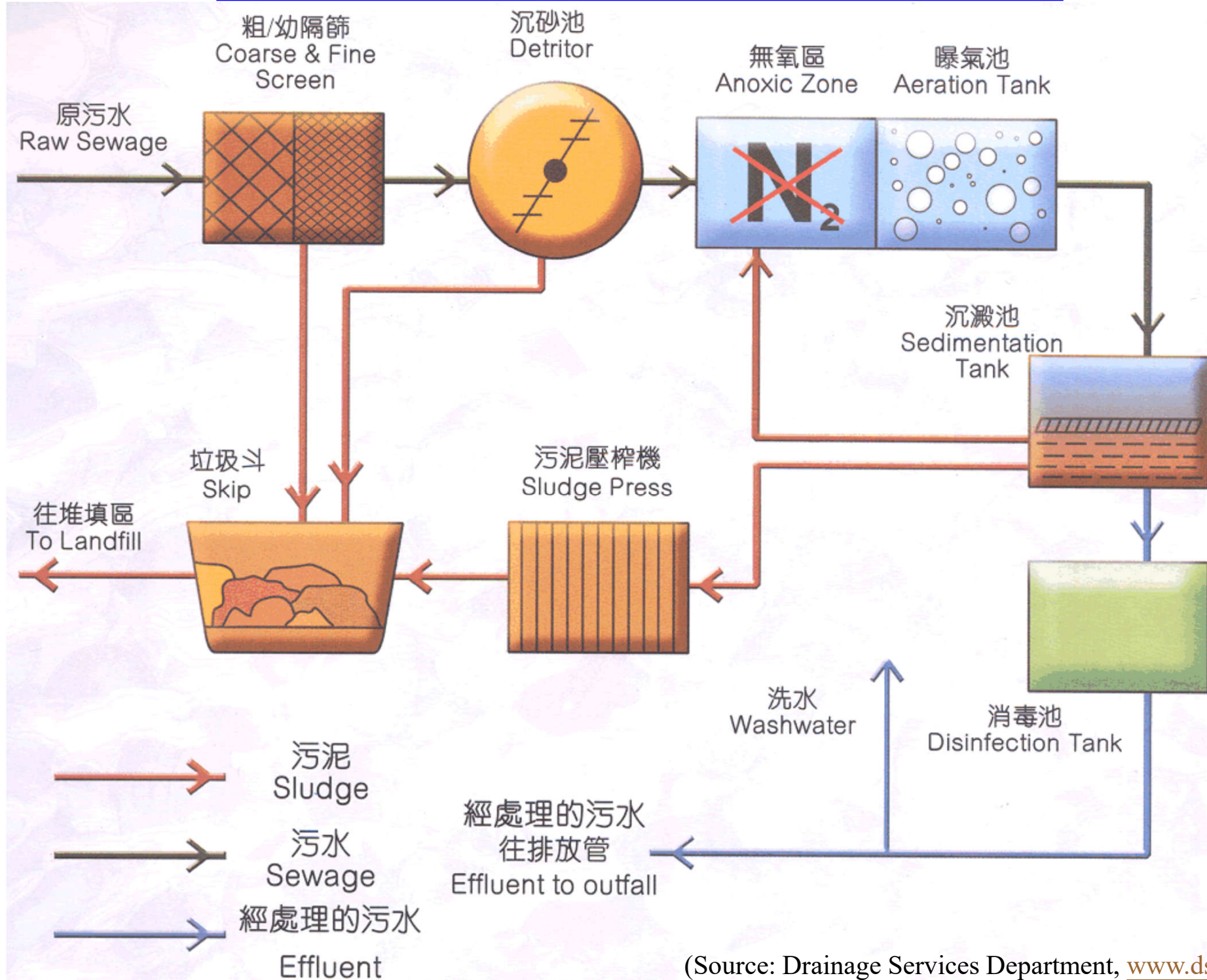

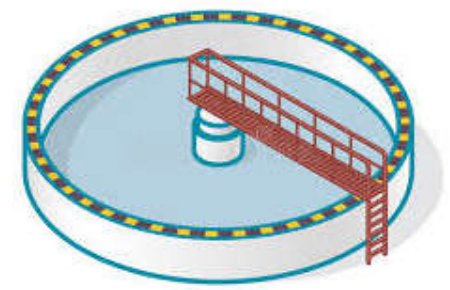

Sewage treatment process

- Ngong Ping Sewage Treatment Works
 - <https://www.dsd.gov.hk/EN/HTML/20517.html>
 - For Ngong Ping cable car & surrounding areas (environmentally sensitive)
 - The first tertiary sewage treatment plant with reclaimed water facilities in Hong Kong
 - High quality effluent good for reuse
 - Adopt the technology of Sequencing Batch Reactor (SBR), dual media filter and disinfection process to reduce organic pollutants, suspended solids, nutrients & pathogenic organisms

Treatment process at Ngong Ping Sewage Treatment Works

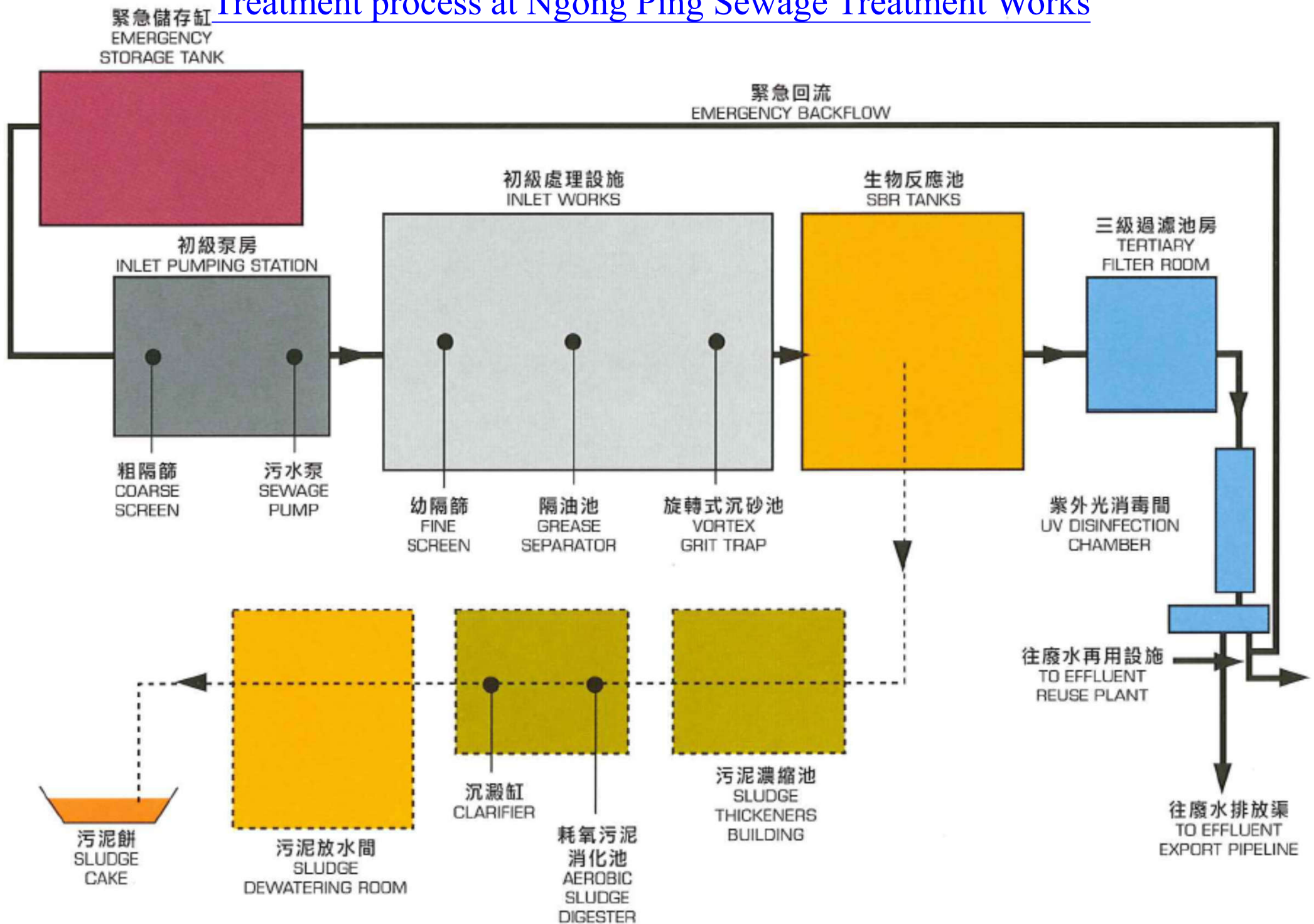

(Source: Drainage Services Department, www.dsd.gov.hk)

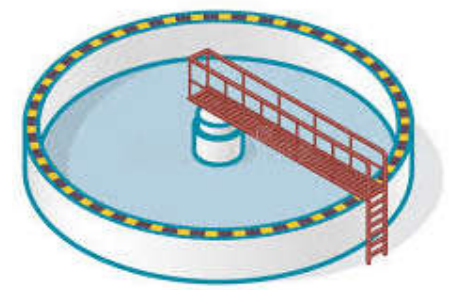

Sewage treatment process

- Reclaimed water (再造水) trial scheme in HK
 - For flushing at public toilets in Ngong Ping & cable car terminal; at Shek Wu Hui, for toilet flushing & non-potable uses
 - Highly treated wastewater:
 - Clear in appearance, odourless and is safe for use
 - Contains a low level of nutrients (nitrogen and phosphorus)
 - Can be beneficial to plant growing (reduce fertilizer use)

Water reclamation process in Hong Kong

→ Reclaimed Water Distribution System

→ Treated Effluent

→ Sewerage System

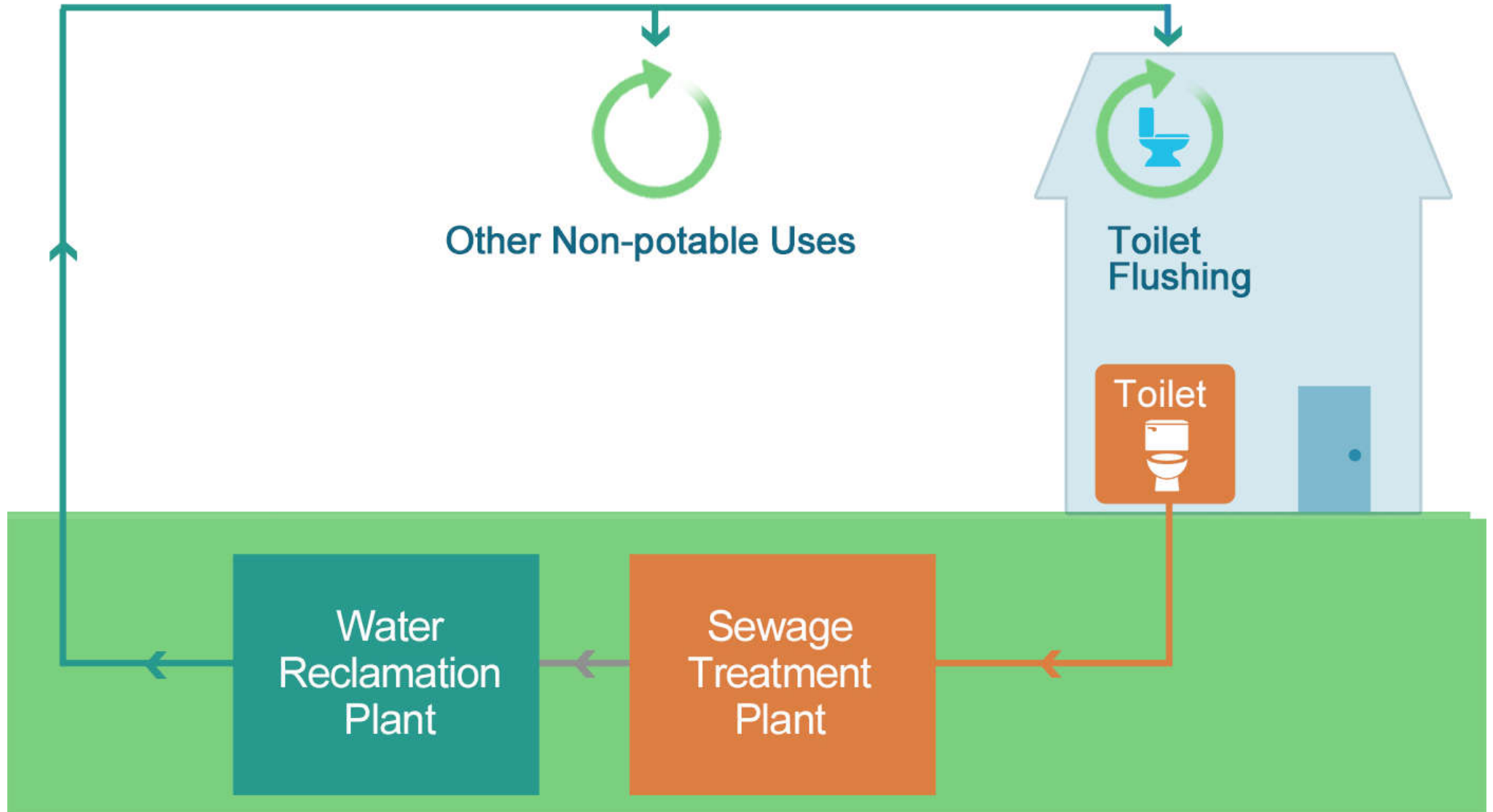

Example: Rainwater recycling system for house

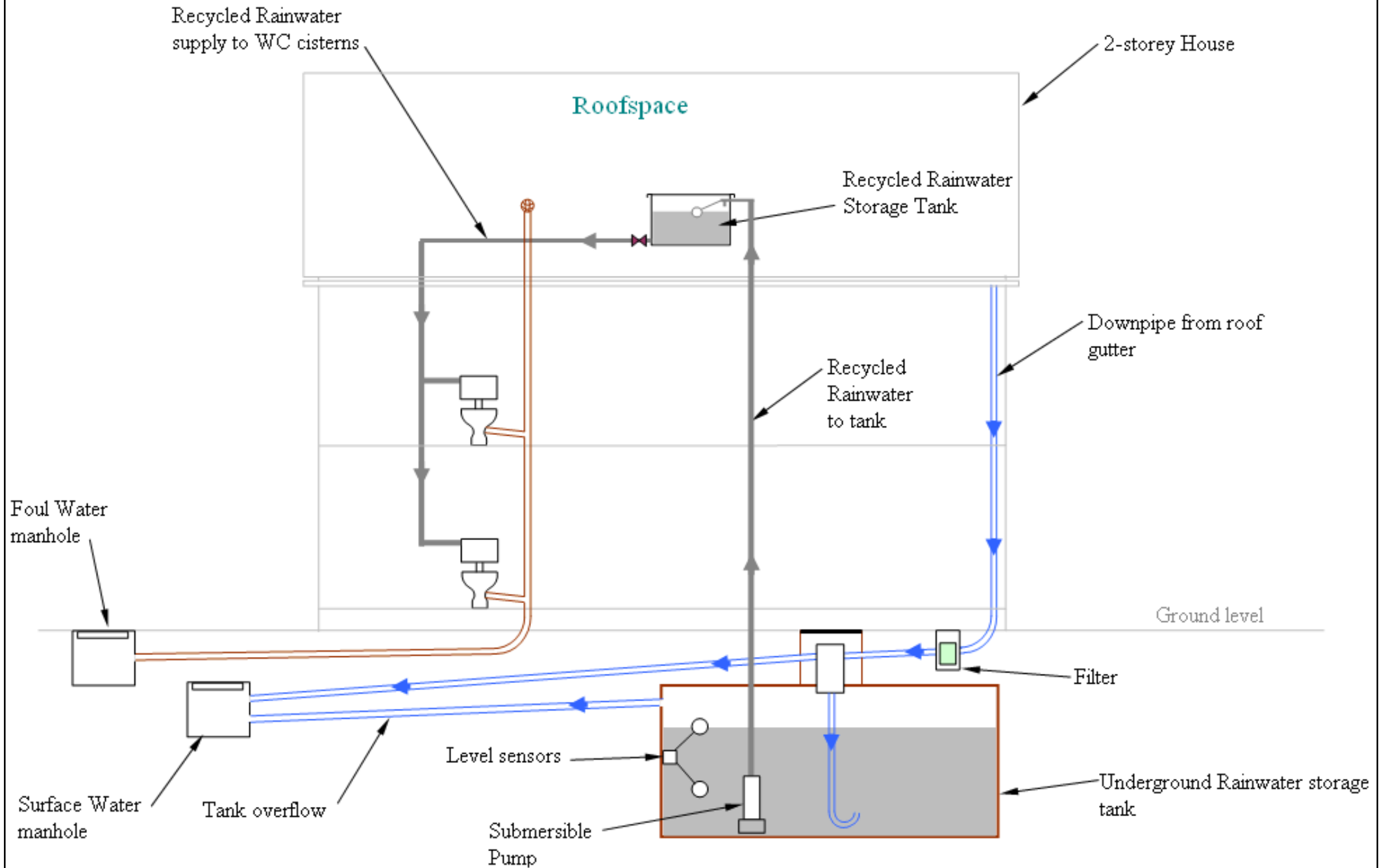

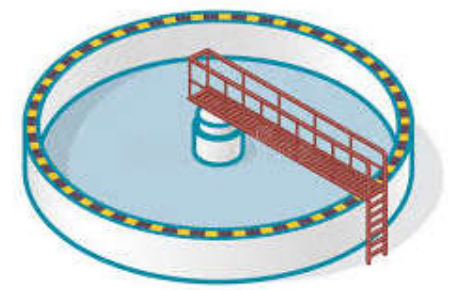

Sewage treatment process

- Grey water reuse & rainwater harvesting
 - Collection of grey water & rainwater
 - Collection & storage tanks, pumps
 - Treatment of grey water & rainwater
 - Assess quantity of supply & demand
 - Yield of grey water & rainwater
 - Estimate grey water & rainwater demand
 - Installation, operation & maintenance
 - Marking & proper use of treated reclaimed water



Grey water recycling and rainwater harvesting system

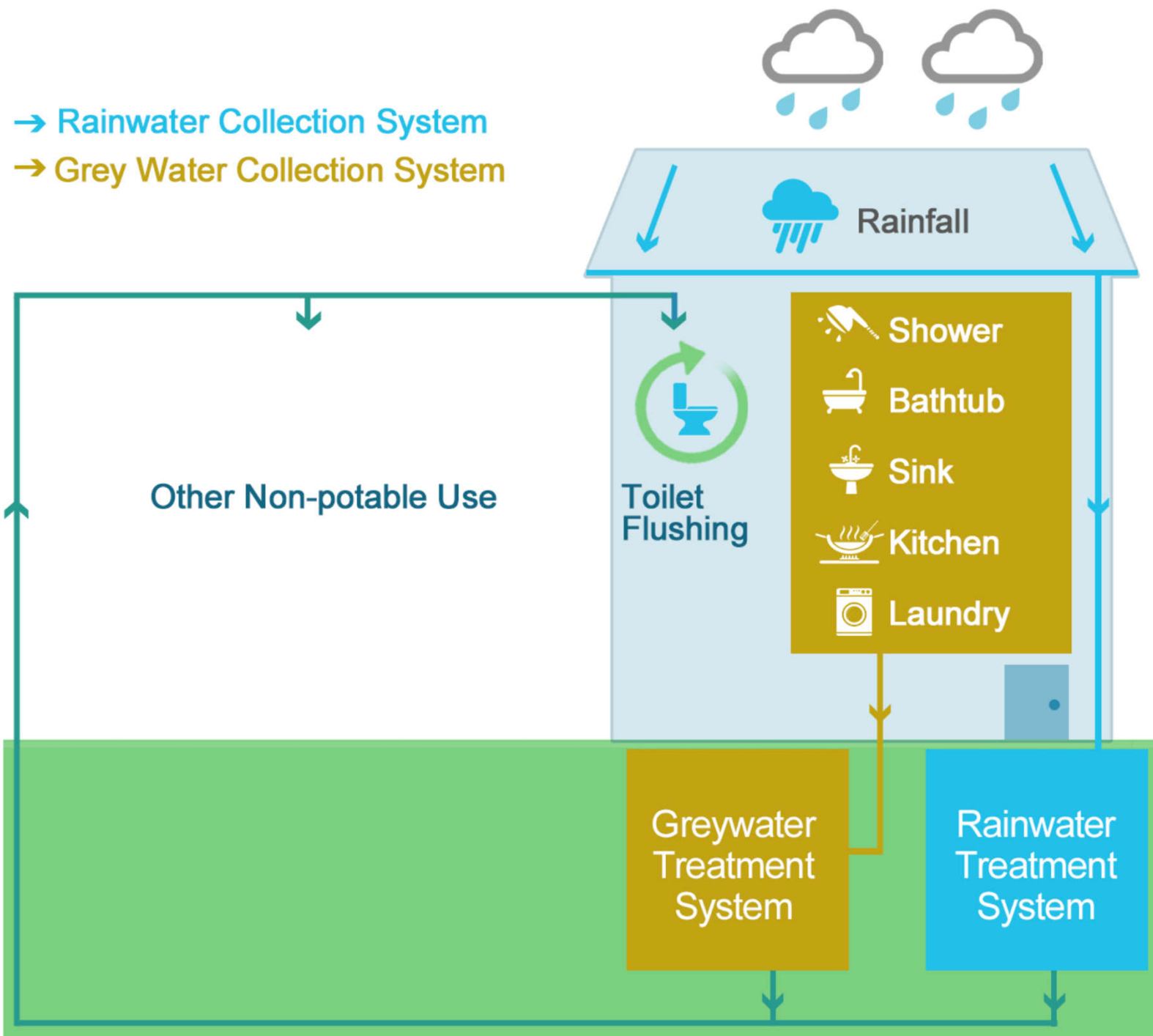

Grey water and rainwater sources and end uses

Grey Water Sources	Rainwater Sources	Potential End Use After Treatment
<ul style="list-style-type: none"> • Wash basins • Baths • Showers • Dishwashers • Laundry machines • Kitchen sinks • Air conditioning condense 	<ul style="list-style-type: none"> • Roofs • Permeable paving • Non-permeable paving • Surface runoff from grass and landscaped areas 	<ul style="list-style-type: none"> • Toilet flushing • Drip irrigation • Sprayed irrigation • Water features • Car washing • External cleaning • Fire fighting • Industrial processes

Treated grey water and rainwater (hereafter referred to as “reclaimed water”) shall be prohibited from the following uses:

- (a) Consumed by humans or animals
- (b) Used for bathing or showering
- (c) Used to top-up swimming pools or spas
- (d) Used for food preparation or washing dishes or kitchen appliances
- (e) Used for irrigating in a way that will contact edible parts of herbs, fruit, or vegetables
- (f) Piped to hot water services

(Source: Technical Specifications on Grey Water Reuse and Rainwater Harvesting 重用洗盥污水及集蓄的雨水技術規格

https://www.wsd.gov.hk/filemanager/en/content_1459/technical_spec_grey_water_reuse_rainwater_harvest.pdf)

Schematic diagram for combined grey water & rainwater treatment

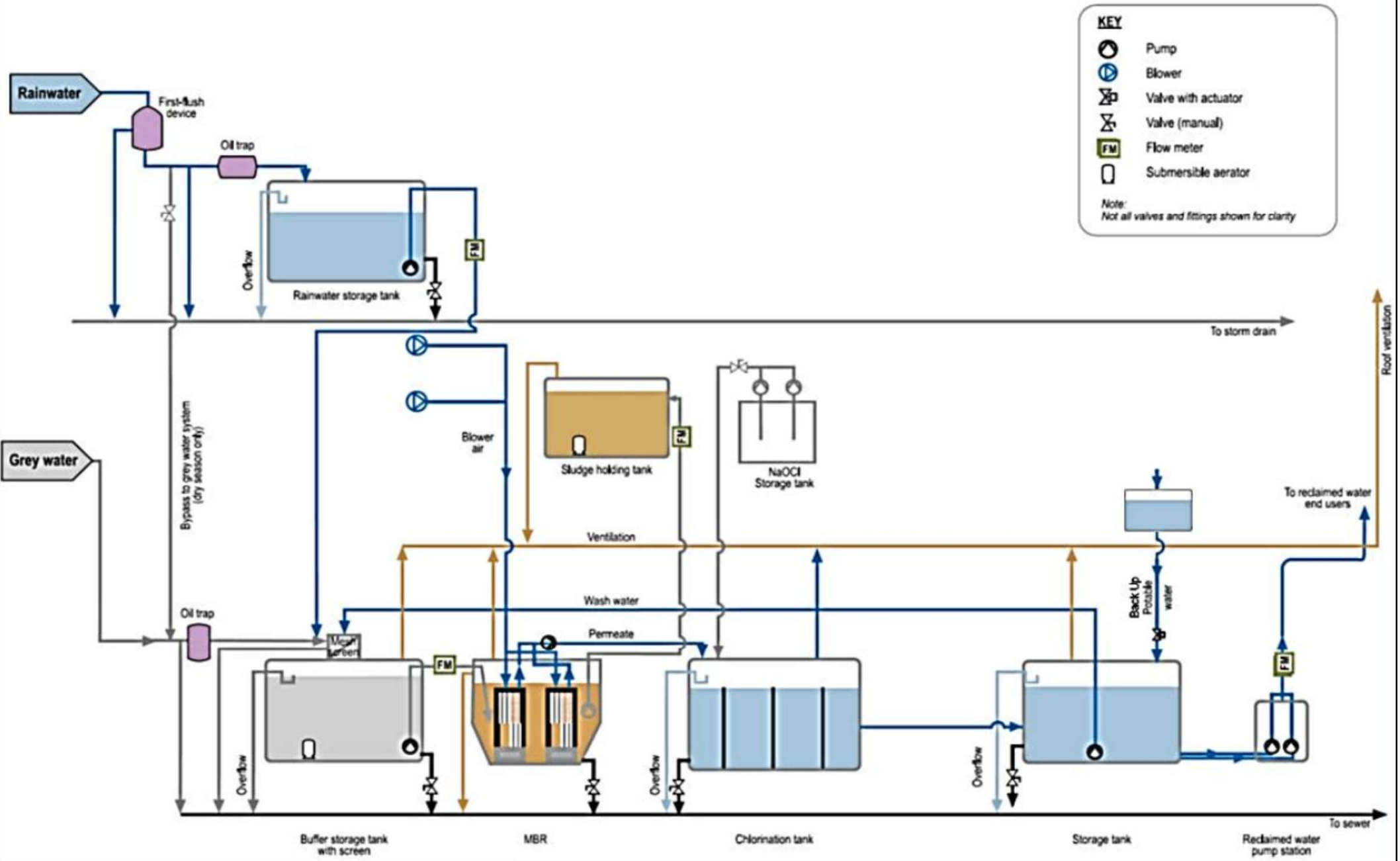

(Source: Technical Specifications on Grey Water Reuse and Rainwater Harvesting 重用洗滌污水及集蓄的雨水技術規格
https://www.wsd.gov.hk/filemanager/en/content_1459/technical_spec_grey_water_reuse_rainwater_harvest.pdf)

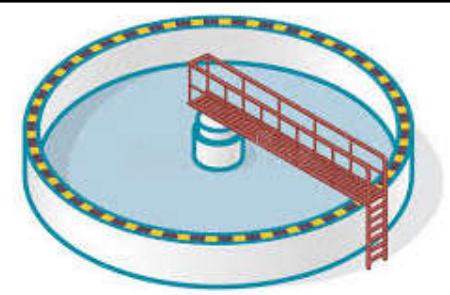

Sewage treatment process

- Reclaimed water (再造水) (cont'd)
 - Benefits: better use of treated wastewater, save water, protect our environment, better quality water for irrigation
- In Singapore, the brand name is NEWater (新生水)
 - High-purity reclaimed water
 - Treated wastewater purified using dual-membrane (via microfiltration and reverse osmosis) and ultraviolet technologies, in addition to the water treatment processes
 - The water is potable and is consumed by humans
 - But is mostly used for industry requiring high purity water



NEWater technology in Singapore

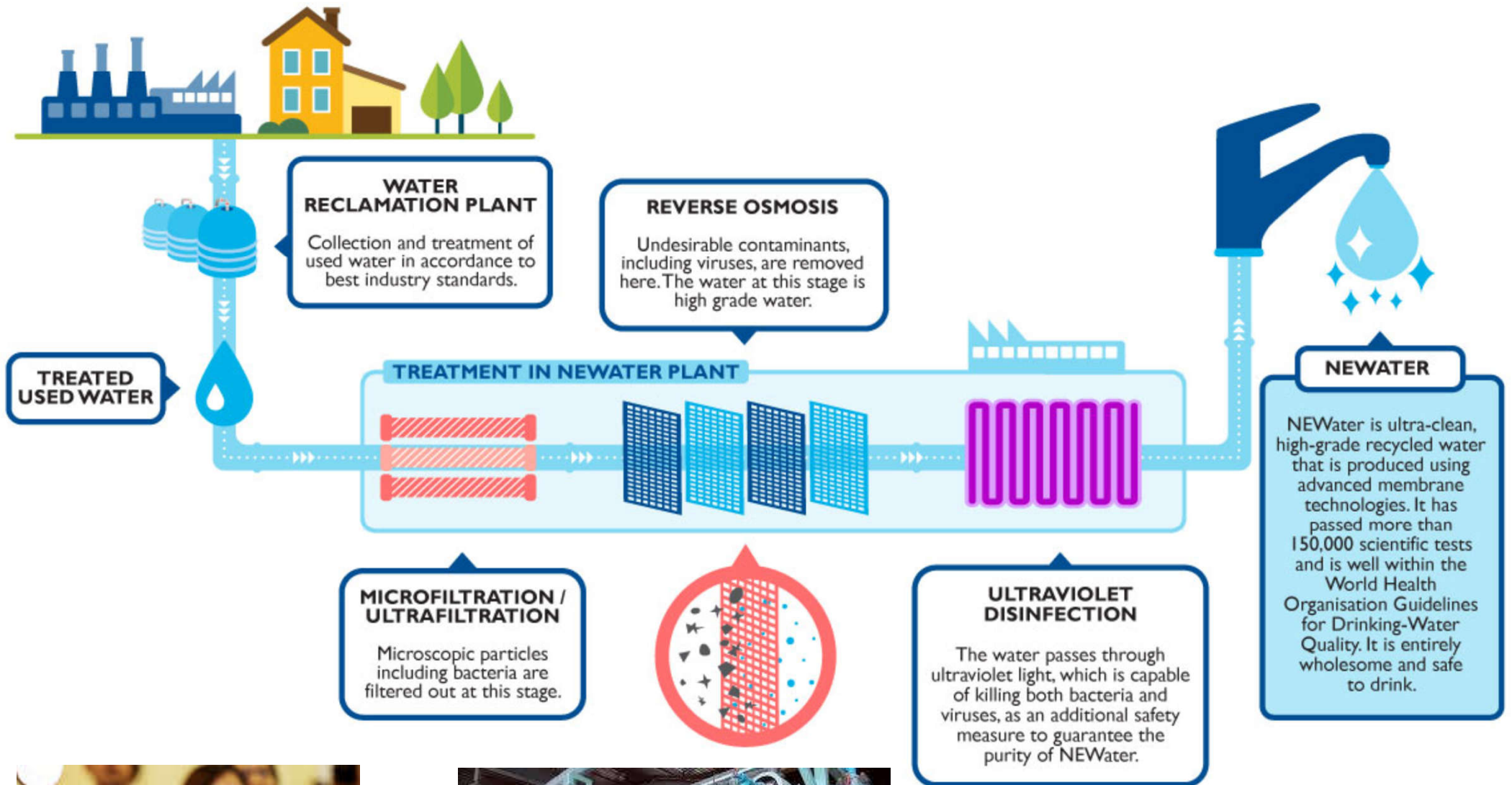

(Source: <https://www.pub.gov.sg/watersupply/fournationaltaps/newater>)



Further Reading

- Connections to Sewers Under the Water Pollution Control Ordinance
 - https://www.epd.gov.hk/epd/english/environmentinhk/water/guide_ref/guide_wpc_csuw.html
- Guidance Notes on Discharges from Village Houses
 - https://www.epd.gov.hk/epd/english/environmentinhk/water/guide_ref/guide_wpc_dv.html
- Guidelines for the Design of Small Sewage Treatment Plants
 - https://www.epd.gov.hk/epd/english/environmentinhk/water/guide_ref/guide_wpc_stp.html

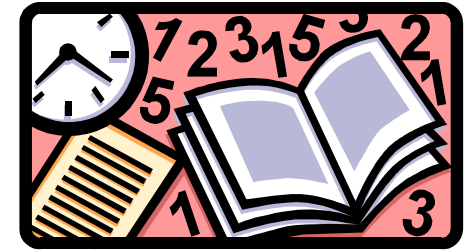

References

- Burberry P., 2013. *Environment and Services*, 9th ed., Chp. 13, Routledge, Abingdon, Oxon.
- CIBSE, 2004. *Public Health Engineering*, CIBSE Guide G, Chps 10, Chartered Institution of Building Services Engineers (CIBSE), London. [LB 628 P97]
- DSD, 2013. *Sewerage Manual (with Eurocoes incorporated): Part 1, Key Planning Issues and Gravity Collection System*, Third Edition, Drainage Services Department, Hong Kong.
[https://www.dsd.gov.hk/EN/Technical_Documents/Technical
Manuals/](https://www.dsd.gov.hk/EN/Technical_Documents/Technical_Manuals/)
- Hall F. & Greeno R., 2017. *Building Services Handbook*, 9th ed., Routledge, Oxon & New York.