

# MEBS6000 Utility Services

<http://ibse.hk/MEBS6000/>



## Introduction to Utility Services



*Ir Dr. Sam C. M. Hui*

Department of Mechanical Engineering

The University of Hong Kong

E-mail: [cmhui@hku.hk](mailto:cmhui@hku.hk)

Jan 2023



# About the Lecturer

- ***Ir Dr. Sam C. M. Hui*** 許俊民 博士 工程師 <http://ibse.hk/cmhui>
  - Adjunct Assistant Professor 客席助理教授, HKU Dept of Mech Engg
  - PhD, BEng(Hons), CEng, CEM, BEMP, HBDP, MASHRAE, MCIBSE, MHKIE, MIESNA, LifeMAEE, AssocAIA
    - CEng = Chartered Engineer
    - CEM = Certified Energy Manager
    - BEMP = Building Energy Modeling Professional
    - HBDP = High-performance Building Design Professional
    - LifeMAEE = Life Member, Association of Energy Engineers
    - AssocAIA = Associate Member, American Institute of Architects
  - ASHRAE Distinguished Lecturer (2009-2011)
  - President, ASHRAE Hong Kong Chapter (2006-2007)



# Contents

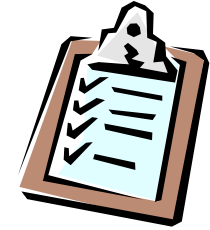

- Course background
- What are Utility Services?
- Building Services Engineering
- Design & operation issues

# Course background

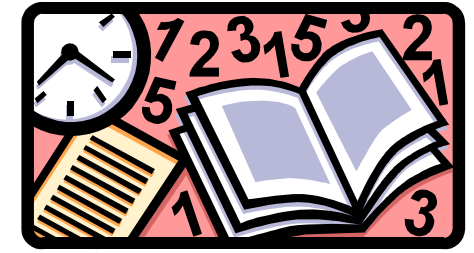

- Educational Objectives:

- To enable students to appreciate the various utility systems in the areas of water supply, sanitation and drainage, gaseous fuel, steam supply, security and access control system, etc.
- To introduce students to the principles of design and operation of various utility systems.
- To enable students carry out engineering design calculations in utility systems under the constraints of statutory requirements and professional guidelines.
- To introduce students to various utility services installations in modern buildings.



# Course background

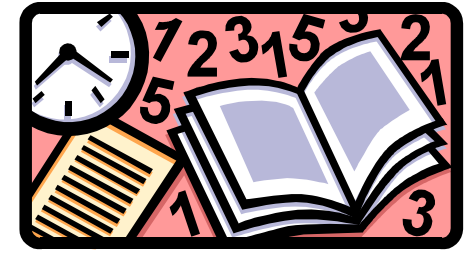

- Learning Outcomes:

- To explain the various utility service systems in water supply, sanitation and drainage, gaseous fuel system, steam system, security and access control system.
- To carry out preliminary design and conduct engineering design calculations for the various utility service systems.
- To critically evaluate the design of utility service systems.

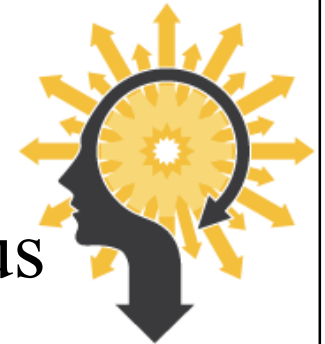

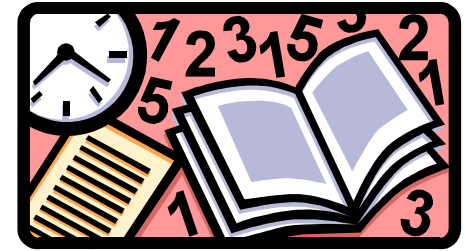

# Course background

- Prerequisite:
  - Engineering fundamentals on fluid mechanics and electrical engineering
- Assessment Methods:
  - 60% by written examination (2 hours)
  - 40% by continuous assessment (2 nos. assignments)
- Course Website:
  - <http://ibse.hk/MEBS6000/>

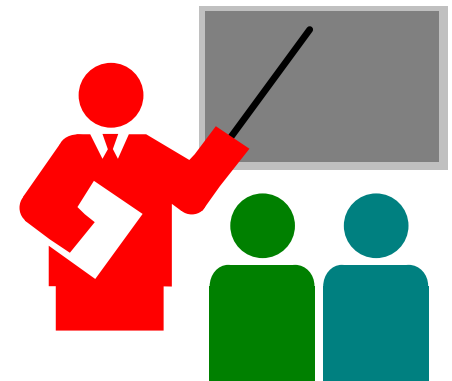

# MEBS6000 Utility Services: Study topics

- |  |   |
|--|---|
| <ol style="list-style-type: none"><li>1. Introduction to Utility Services</li><li>2. Cold Water Supply</li><li>3. Hot Water Supply</li><li>4. Design of Water Supply Systems</li><li>5. Sanitation and Drainage</li><li>6. Sewage Disposal</li></ol> | <ol style="list-style-type: none"><li>7. Steam Systems (I)</li><li>8. Steam Systems (II)</li><li>9. Fuel gas supply</li><li>10. Telecommunication Services</li><li>11. Extra Low Voltage Systems</li><li>12. Security Planning &amp; Design</li></ol> |
|--|---|

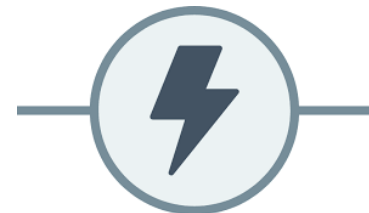
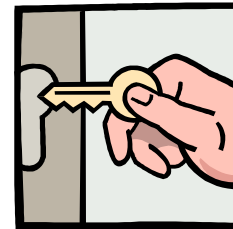
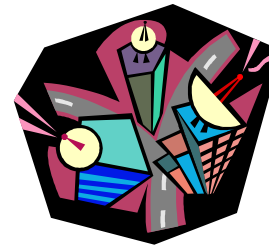
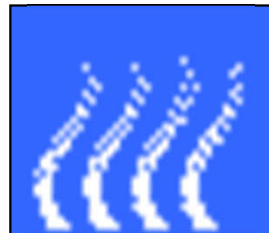
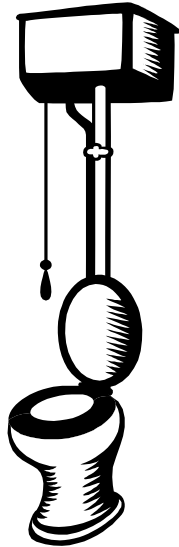

# Course background

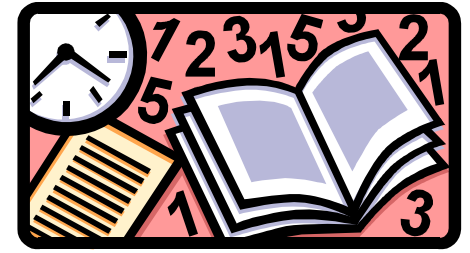

- Study methods
  - Lectures (core knowledge & discussions)
  - Further Readings (essential study information)
  - Videos (illustration & demonstration)
  - References (useful supporting information)
  - Web Links (related links & resources)
- Assignments
  - Practical skills & applications





# Course background

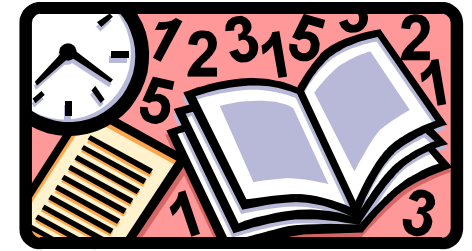

- Related professional institutions:

- Chartered Institution of Building Services Engineers (CIBSE)\* <http://www.cibse.org>



- CIBSE Hong Kong Region <http://www.cibse.org.hk/>
- Membership <https://www.cibse.org/membership>

- Hong Kong Institution of Engineers (HKIE) 香港工程師學會 <http://www.hkie.org.hk/>

- Building Services Division 屋宇裝備分部  
<https://www.hkie-bsd.org/>



Building Services Division  
屋宇裝備工程分部

(\*Video: CIBSE Membership Professional Registration Webinar (35:36) <https://youtu.be/k6FK6Rn3hHQ>)

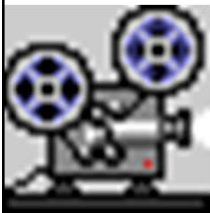

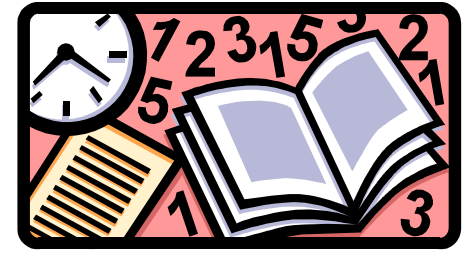

# Course background

- Building services engineering (BSE) related professionals
  - Consulting/design engineer
  - Contracting engineer
  - BS coordinator (main/civil contracting firms)
  - Project manager/engineer (for developers)
  - Government's engineer
  - Engineer for quasi-government bodies
  - Sale engineer of M/E equipment suppliers
  - Facility management or maintenance engineer

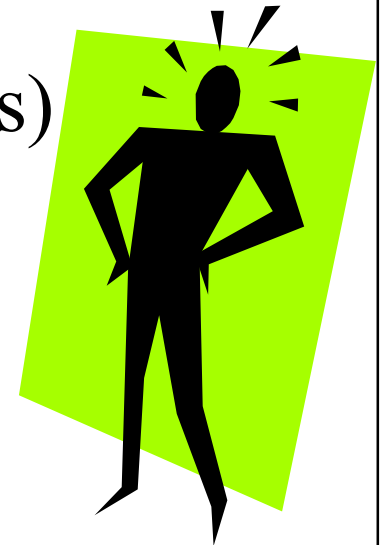

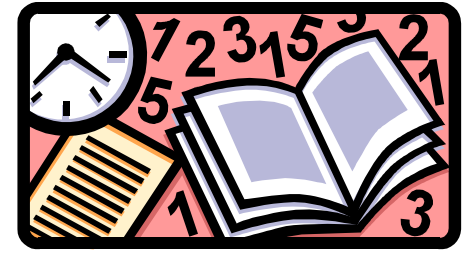

# Course background

- HKIE Routes to Membership:
  - Academic requirements
  - Training and experience requirements
  - Continuing professional development (CPD) requirements
  - Professional assessment
- Admission via Reciprocal Recognition Agreements (RRA)
  - Such as CIBSE membership

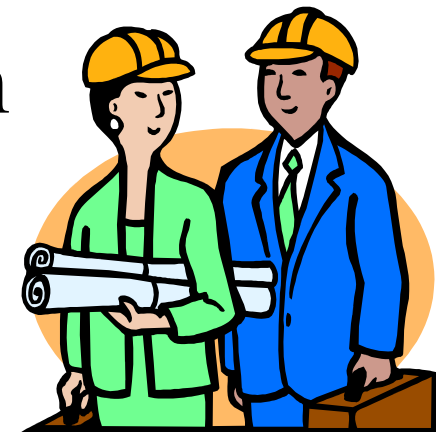

# HKIE Routes to Corporate Membership

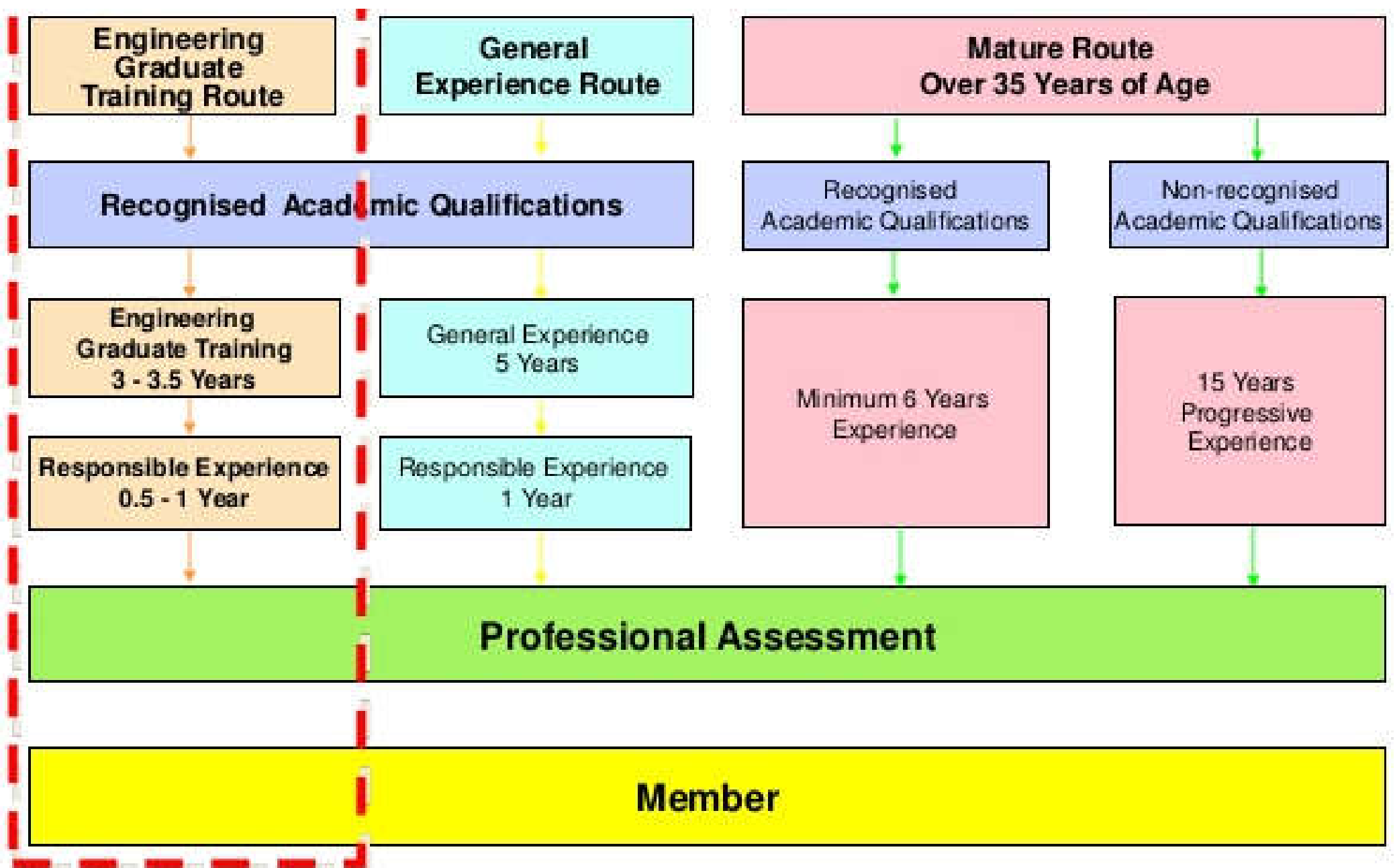

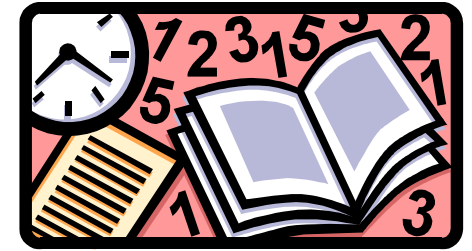

# Course background

- Admission requirements for HKIE Building Services Discipline

[https://hkie.org.hk/en/membership/download\\_mem2/](https://hkie.org.hk/en/membership/download_mem2/)

- Top up requirements - Six core subject areas:
  - Heating, Ventilation and Air-Conditioning (HVAC)
  - Electrical Services
  - Fire Services
  - Utility Services
  - Lighting Engineering
  - Project and Engineering Management



# What are Utility Services?



# What are Utility Services?



- Terminology

屋宇裝備 / 屋宇設備 /  
建築設備 / 機電工程

- Building Services
- M/E (mechanical/electrical) or E/M
- MEP (mechanical, electrical, plumbing)
- (Building) Environmental Engineering
- Building Engineering
- Architectural Engineering/Technology
- Public Health Engineering
- Utility Services



# What are Utility Services?



- Utility Services 公用設施
  - Infrastructure services or “public” services, e.g.
    - Electricity, water supply, drainage & wastewater treatment, gas supply, telephone services
  - Provided by government departments, public utility companies or private companies
  - Fundamental to modern living
  - Essential components of the basic infrastructure





# What are Utility Services?



- Hong Kong: the Facts
  - Power and Gas Supplies  
[https://www.gov.hk/en/about/abouthk/factsheets/docs/power\\_gas\\_supplies.pdf](https://www.gov.hk/en/about/abouthk/factsheets/docs/power_gas_supplies.pdf)
  - Water Supplies  
<https://www.wsd.gov.hk/en/publications-and-statistics/publications/the-facts/>
  - Telecommunications  
<https://www.gov.hk/en/about/abouthk/factsheets/docs/telecommunications.pdf>

# Hong Kong Planning Standards and Guidelines (香港規劃標準與準則)

[https://www.pland.gov.hk/pland\\_en/tech\\_doc/hkpsg/](https://www.pland.gov.hk/pland_en/tech_doc/hkpsg/)

## Chapter 7 Utility Services (公用設施)

- Electricity Supply 電力供應
- Gas Supply 氣體供應
- Telephone Service 電話服務
- Radio Telecommunications and Broadcasting Service 無線電通訊及廣播服務
- Water Supply 供水
- Drainage Services 渠務設施
- Dedicated Utility Reserves 公用設施專用範圍
- District Cooling System 區域供冷系統



# What are Utility Services?



- Utilities in Hong Kong
  - Are owned by government departments, public utility companies or private owners
  - The owners of the utilities are supposed to possess the information of their utilities, therefore, any person who want to carry out utility works can obtain record plan of the vicinity to have a better picture of the underground utility system
  - Utility connections & supply applications

# Related government departments & utility companies in Hong Kong

Government Departments	Utility Companies
<ul style="list-style-type: none"> <li>• Water Supplies Department (WSD)</li> <li>• Housing Department (HD) (for housing area)</li> <li>• Fire Services Department (FSD)</li> <li>• Architectural Services Department (ArchSD) (for government residential area)</li> <li>• Buildings Department (BD) (for private buildings)</li> <li>• Drainage Services Department (DSD)</li> <li>• Highways Department</li> <li>• Electrical and Mechanical Services Department (EMSD)</li> </ul>	<ul style="list-style-type: none"> <li>• China Light and Power Company Limited</li> <li>• Hong Kong and China Gas Company Limited</li> <li>• Hongkong Electric Company Limited</li> <li>• Hong Kong Broadband Network Limited</li> <li>• Hong Kong Cable Television Limited</li> <li>• Hong Kong Tramway Limited</li> <li>• Hutchison Communications Limited</li> <li>• Mass Transit Railway Corporation</li> <li>• New T &amp; T Hong Kong Limited</li> <li>• New World Telecommunications Limited</li> <li>• PCCW-HKT</li> <li>• Telstra International HK Limited</li> <li>• Wharf Communications Ltd</li> </ul>



(Source: UTI, 2011. *Guide to Utilities Management*, Utility Training Institute (UTI), Hong Kong.

<http://www.hkius.org.hk/uploads/2/8/1/3/28134743/k.um.pdf>)

# What are Utility Services?



- This course will cover:
  - Cold & hot water supplies (plumbing)
  - Sanitary & stormwater drainage
  - Sewage disposal
  - Steam systems
  - Fuel gas supply
  - Telecommunication services
  - Extra-low voltage electrical systems
  - Security planning & design

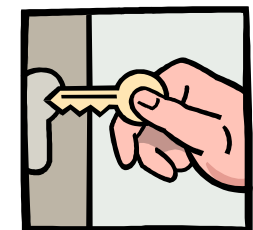
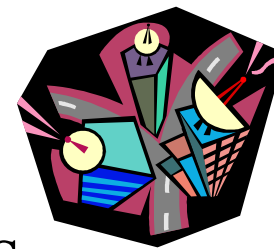

# What are Utility Services?



- Legislative framework:
  - Ordinances & Regulations
- Technical documents:
  - Codes of Practice (CoP) & design manuals
  - Technical memorandum & technical notes
  - Guidelines & guidebooks
  - Practice notes, notices & circular letters
  - Standard drawings
  - Technical Specifications





## Major ordinances in Hong Kong on utility services

(Can be read at <https://www.elegislation.gov.hk/>)

- Buildings Energy Efficiency Ordinance (Cap. 610) 《建築物能源效益條例》(第610章)
- Buildings Ordinance (Cap. 123) 《建築物條例》(第123章)
- Electricity Ordinance (Cap. 406) 《電力條例》(第406章)
- Fire Safety (Buildings) Ordinance (Cap. 572) 《消防安全(建築物)條例》(第572章)
- Gas Safety Ordinance (Cap. 51) 《氣體安全條例》(第51章)
- Land Drainage Ordinance (Cap. 446) 《土地排水條例》(第446章)
- Lifts and Escalators Ordinance (Cap. 618) 《升降機及自動梯條例》(第618章)
- Sewage Services Ordinance (Cap. 463) 《污水處理服務條例》(第463章)
- Waterworks Ordinance (Cap. 102) 《水務設施條例》(第102章)

# What are Utility Services?



- Examples of codes in Hong Kong:
  - CAP123 Building Ordinance & Regulations
  - Various codes of practices (COP) from ArchSD, BD, FSD, EMSD, WSD and power companies
  - Technical circulars & practice notes
  - General specifications
- Standards from other countries
  - British Standards, IEC, JIS, ASHRAE





# Related government departments & bodies in Hong Kong

## 1. Buildings Department (BD) 屋宇署 <http://www.bd.gov.hk/>

- Building safety - Defective Drainage [https://www.bd.gov.hk/en/safety-inspection/building-safety/index\\_bsi\\_drainage.html](https://www.bd.gov.hk/en/safety-inspection/building-safety/index_bsi_drainage.html)

## 2. Drainage Services Department (DSD) 渠務署 <http://www.dsd.gov.hk/>

- Sewerage 除污淨流 <https://www.dsd.gov.hk/EN/CoreBusiness/Sewerage/>

## 3. Electrical and Mechanical Services Department (EMSD) 機電工程署

<http://www.emsd.gov.hk/>

- Electricity Safety 電力安全 [https://www.emsd.gov.hk/en/electricity\\_safety/](https://www.emsd.gov.hk/en/electricity_safety/)
- Energy Efficiency and Conservation 能源效益及節約 [https://www.emsd.gov.hk/en/energy\\_efficiency/](https://www.emsd.gov.hk/en/energy_efficiency/)
- Gas Safety Office (GasSO) 氣體標準事務處 [https://www.emsd.gov.hk/en/gas\\_safety/](https://www.emsd.gov.hk/en/gas_safety/)
- Lifts and Escalators Safety 升降機及自動梯安全 [https://www.emsd.gov.hk/en/lifts\\_and\\_escalators\\_safety/](https://www.emsd.gov.hk/en/lifts_and_escalators_safety/)

## 4. Water Supplies Department (WSD) 水務署 <http://www.wsd.gov.hk/>

- Plumbing and Engineering 內部喉管及技術 <https://www.wsd.gov.hk/en/plumbing-engineering/>
- Water Safety in Buildings 建築物食水安全 <https://www.wsd.gov.hk/en/water-safety/>

# What are Utility Services?



- Utility connections
  - Typically enter a building below ground
  - Demarcation line or interface at the lot boundaries
  - Metering arrangement
  - Isolation valves or switches
  - Rising mains to serve the building
- Utility companies/providers
  - May have their own requirements
    - Such as power & gas companies

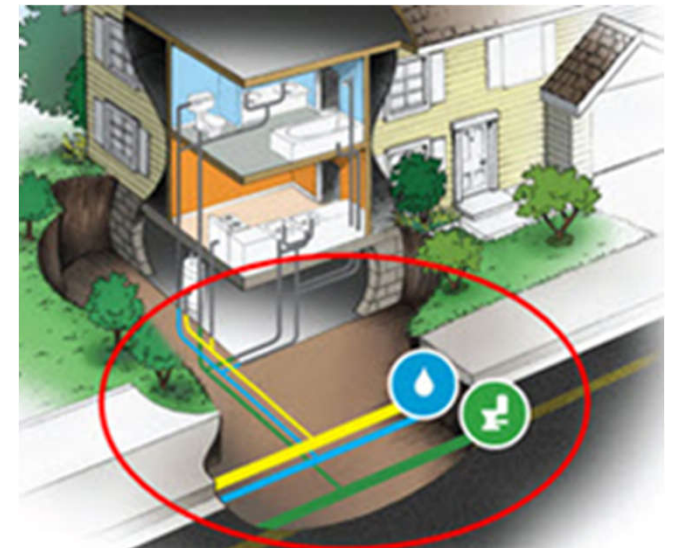

# Example of a site plan with existing utilities

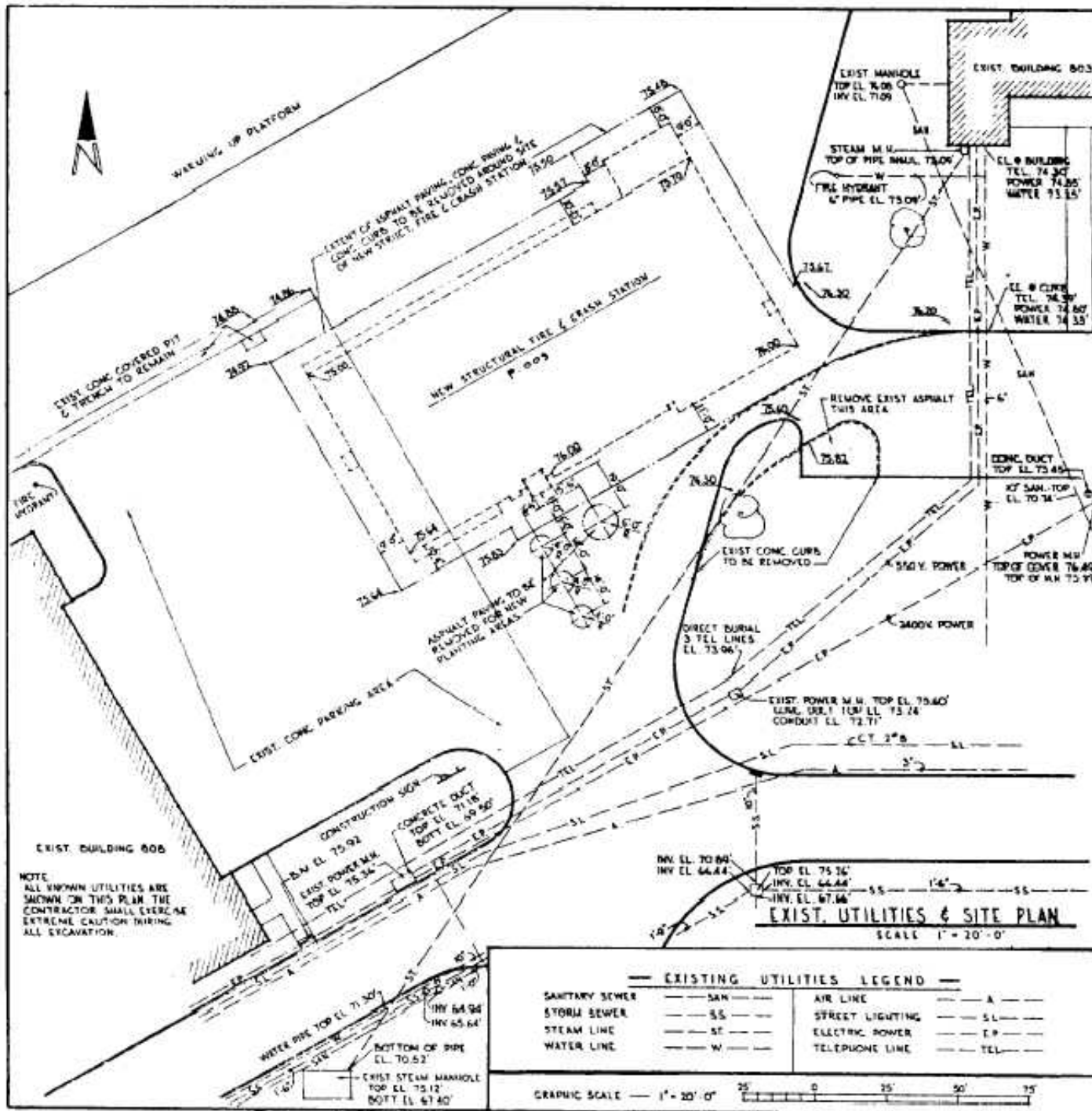

- Existing utilities:
- Sanitary sewer
  - Storm sewer
  - Water line
  - Street lighting
  - Electric power
  - Telephone line

## Different types of utilities buried underground in Hong Kong

Utilities	Description
Power cable	Power cable for electricity supply, the highest voltage cable of China Light and Power (CLP) and Hongkong Electric Company (HEC) are 400 kV and 275 kV respectively.
Water mains	Fresh water referred to treated drinking water for supply to residential and commercial. There is also raw water, untreated water for transportation between reservoirs. Service water mains operate at a pressure range from 7 to 10 bars and over 20 bars for transportation mains between service reservoirs.
Storm drains and foul sewerage	Transport surface water and used water. Separate into the normal gravity flow pipe and pumping main for increase of water head.
Gas pipes	Transportation of town gas and/or natural gas for residential and/or commercial use.
Telecommunication lines	Commercial telephone lines, military communication lines in some areas of Hong Kong.
Cable TV lines	Transfer TV signals for residential and/or commercial use.
Other services	Trains, trams, signal control and other abandoned services.

(Source: UTI, 2011. *Guide to Utilities Management*, Utility Training Institute (UTI), Hong Kong.

<http://www.hkius.org.hk/uploads/2/8/1/3/28134743/k.um.pdf>)

## Recommended depth for underground utilities in Hong Kong (Unit: mm)

Utility type	Footway	Carriageway
Water	600 (minimum depth)	1000 (minimum depth)
Sewerage	450-6000	900-6000
Gas	700 (minimum depth)	700 (minimum depth)
Telecomm	450 (minimum depth)	Not applicable
Electricity (low voltage)	760 (minimum depth)	Not applicable
Electricity (11/22 kV)	900 (minimum depth)	Not applicable

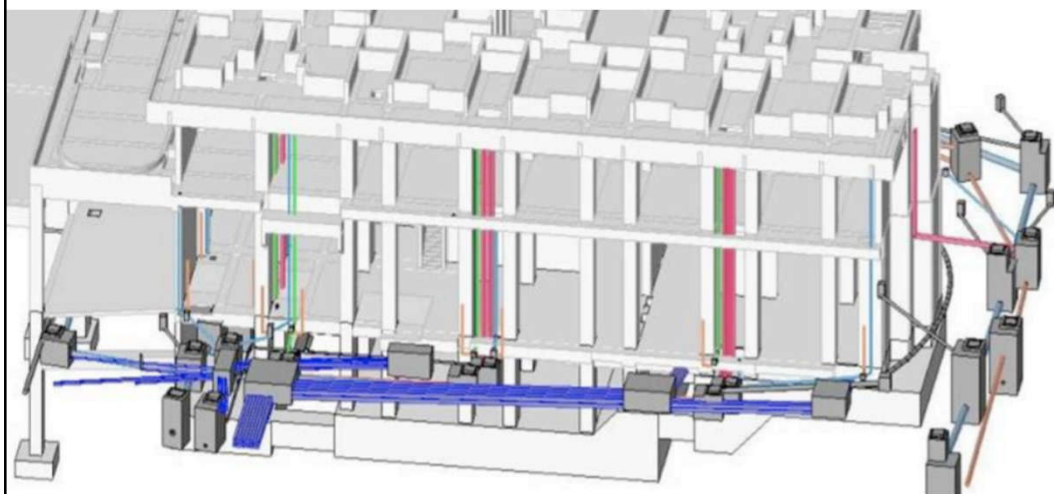

Typical arrangement for utilities buried underground in Hong Kong:

1. Telecommunication lines ~0.5 m depth
2. Gas pipes at 1-2 m below the ground
3. High voltage cable at least 1 m deep
4. The deepest: storm drains & sewerage drains

# What are Utility Services?



- Planning & designing utility connections
  - Alternation & tie-ins to existing infrastructure
- Two dimensions to be considered:
  1. Physical issues associated with equipment & apparatus
    - Planning & installation of cables or pipes; coordination with each other and with other physical encumbrances
  2. Service provision issues associated with availability, capacity & security of the commodity at the point of supply

# Physical aspects of utility services design

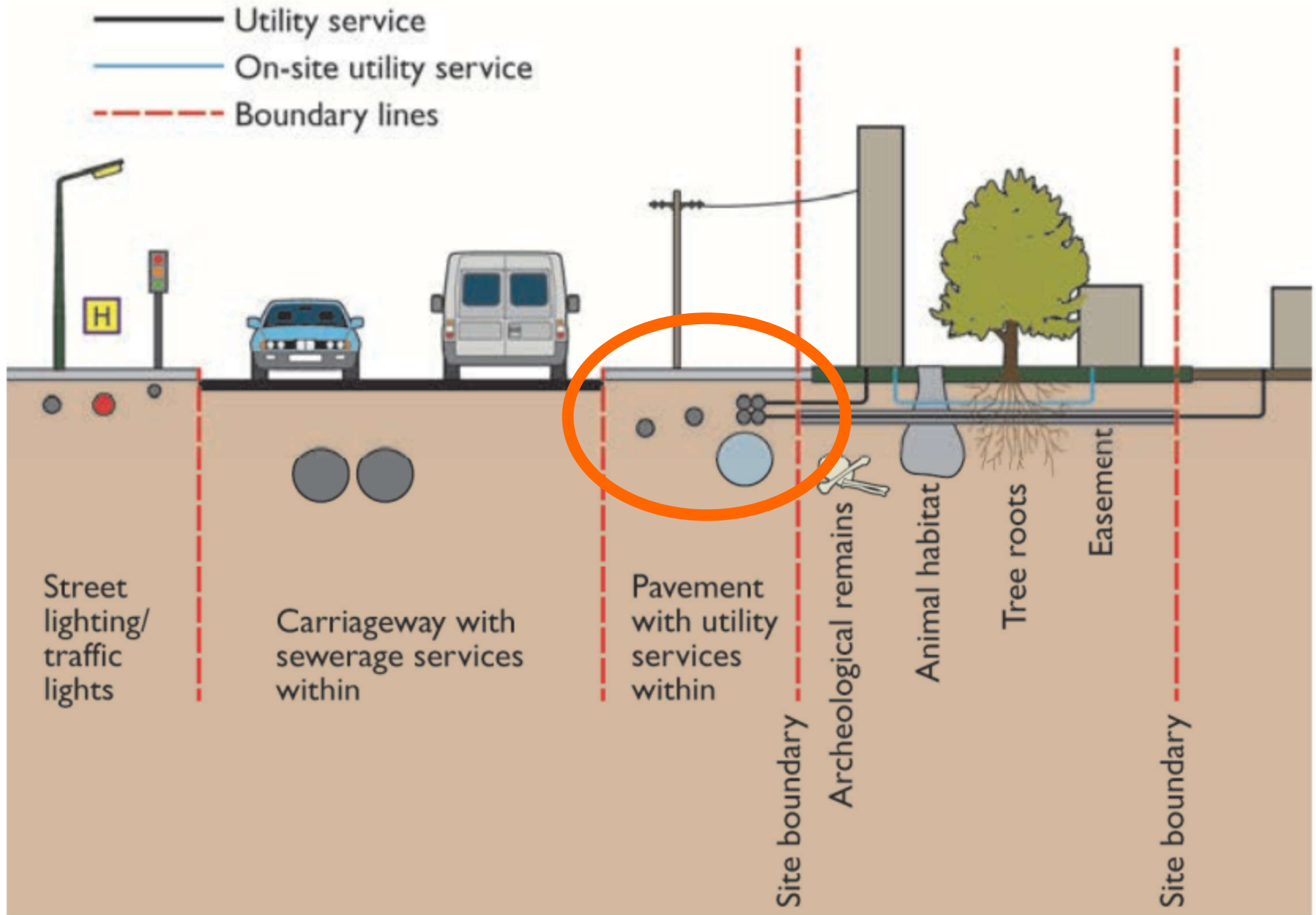

# Recommended depth of utility services under footpath

## Ducting to the building

Must be laid as straight as possible and at a minimum depth of 350mm.

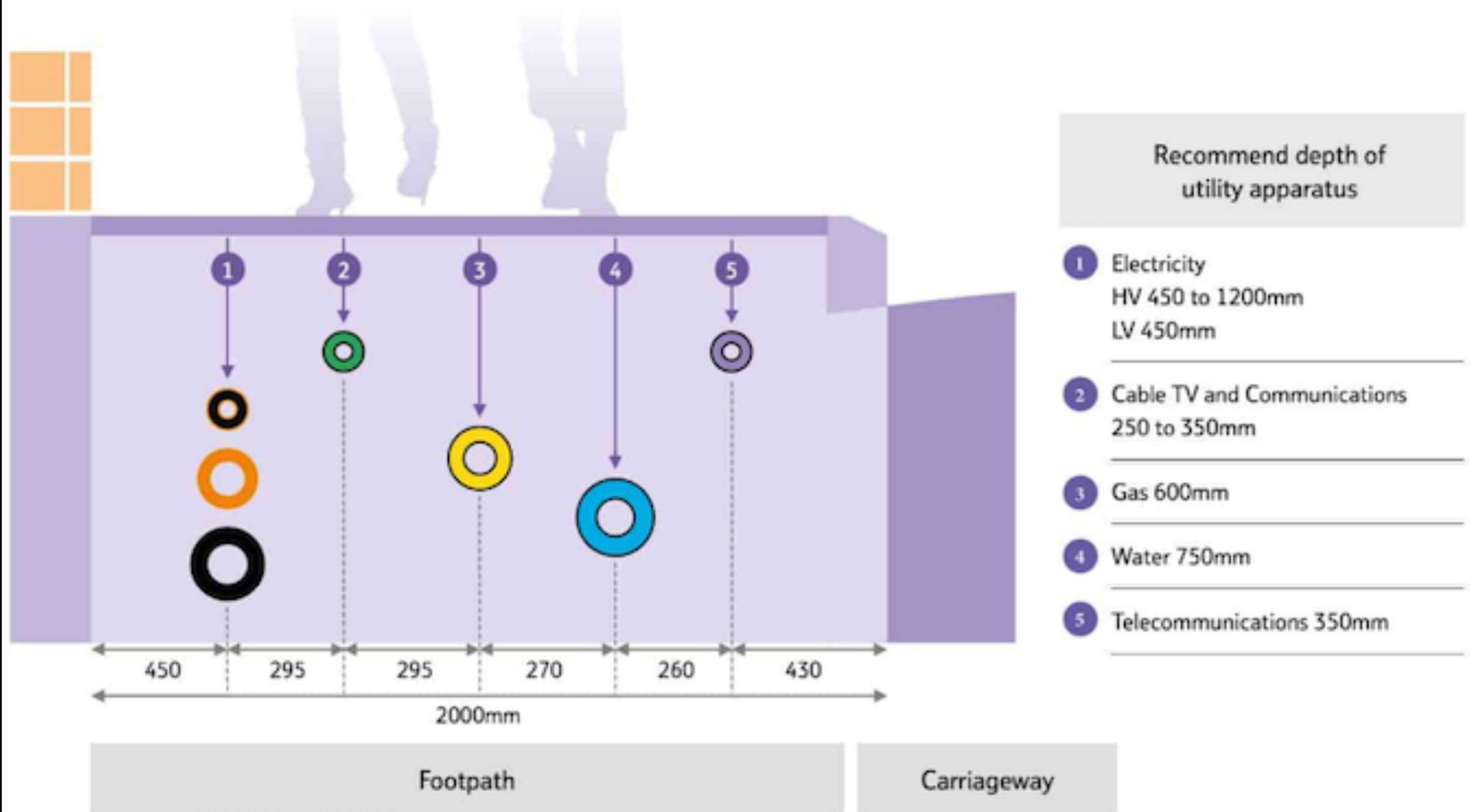



# Typical process of planning & designing utility connections

## 1. Preparation

- Initial site visit
- Availability of utility supply connections

## 2. Record information

- Gather available information (plans & details)
- Surveys (detect & locate the physical equipment underground)

## 3. Capacity requirements

- Information from existing buildings
- Rules of thumb

## 4. Layout planning

- Cable, pipe & duct arrangements
- Plant rooms & space

## 5. Pre-construction

- Coordinated detailed design information
- Applying for quotations for utility services

## 6. Construction

- Detailed planning & documentation
- Site preparation & site works

## 7. Commissioning, handover & occupation



# Design of urban utility tunnel

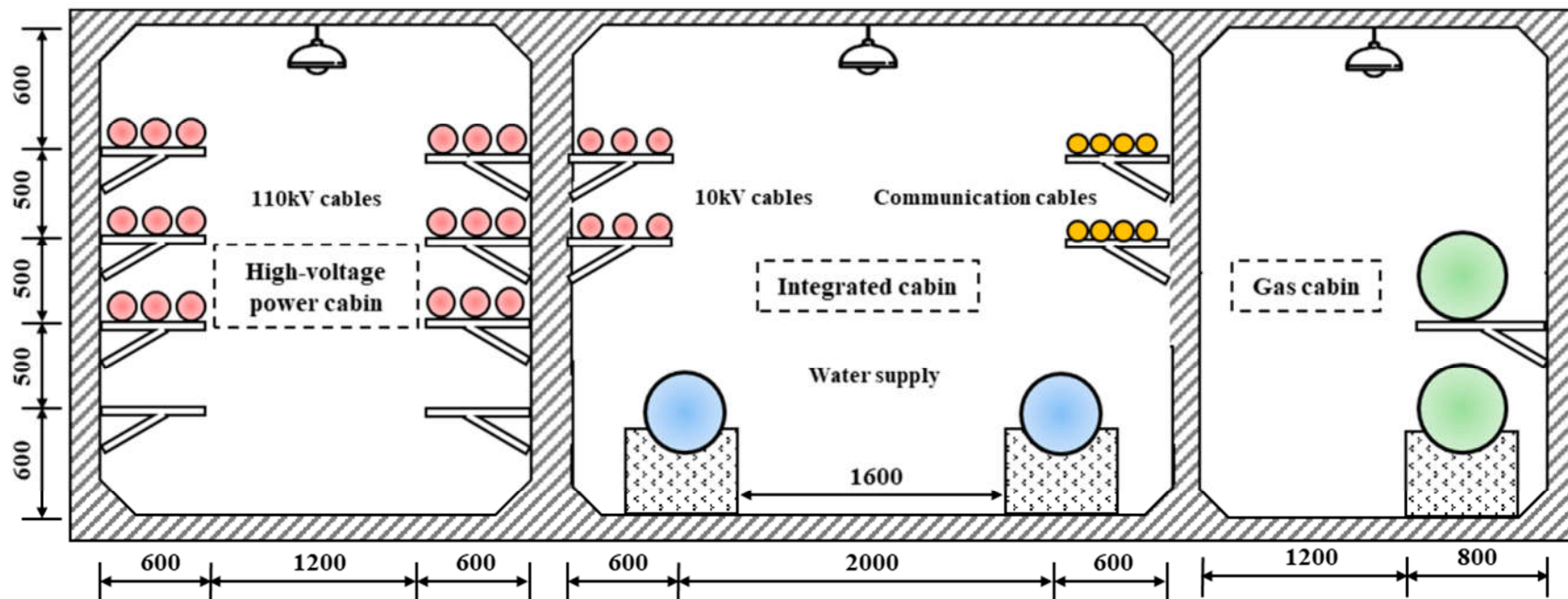
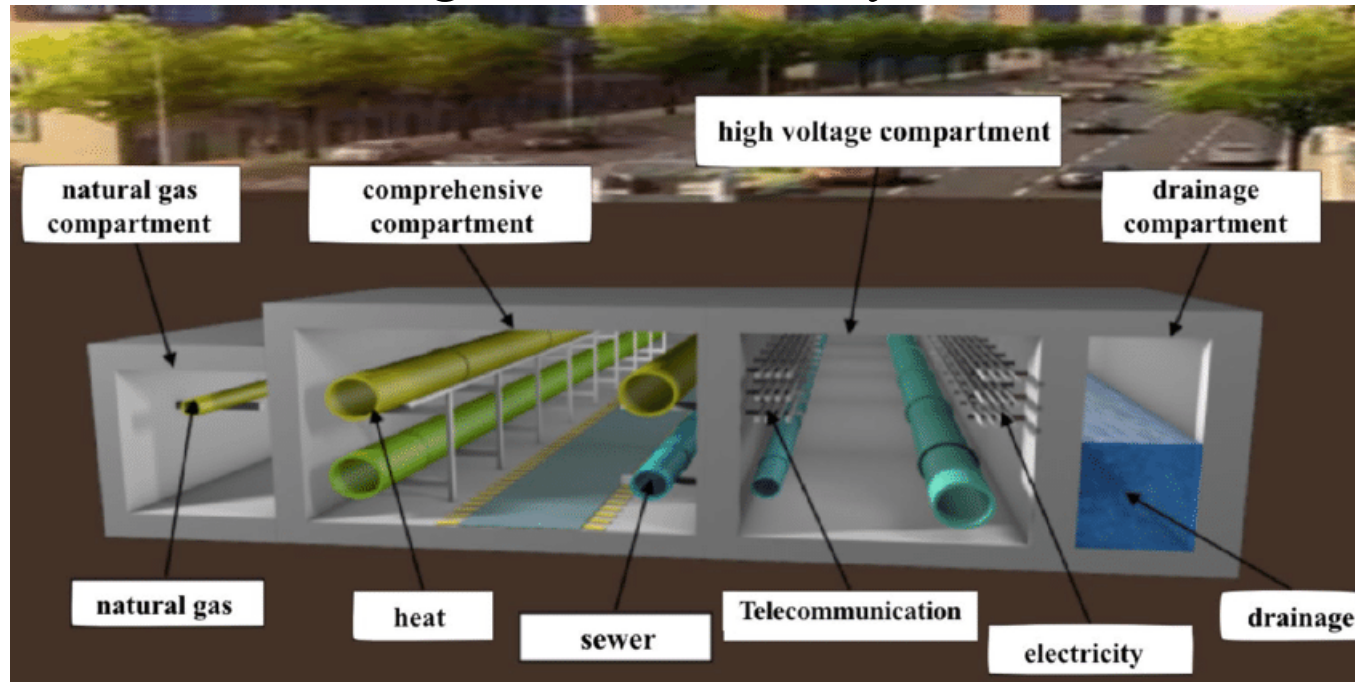

(Source: <https://www.mdpi.com/1996-1073/12/17/3309>;

<https://www.researchgate.net/publication/338145023> Numerical Analysis of the Characteristics of Gas Explosion Process in Natural Gas Compartment of Utility Tunnel Using FLACS/)

# Sub-sea tunnel with service gallery at Tuen Mun-Chep Lap Kok Link

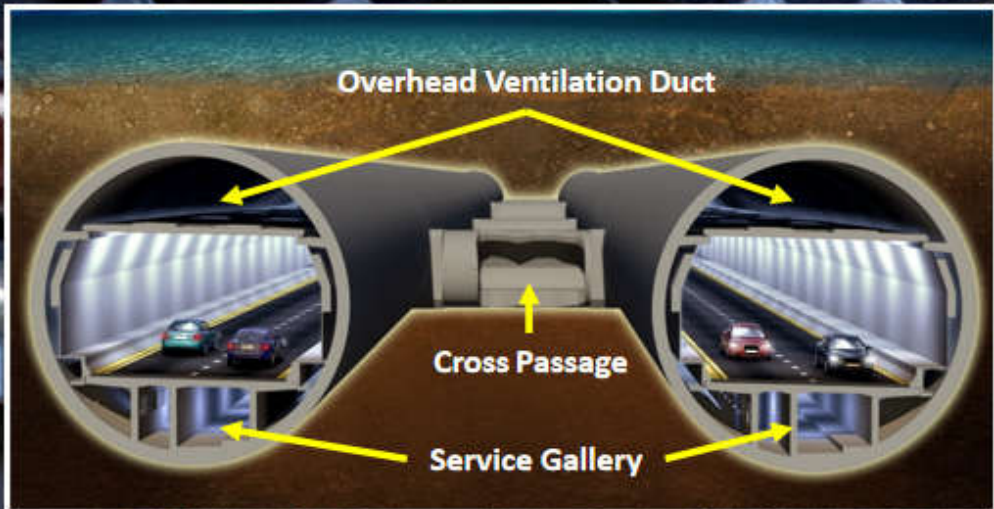

(Source: [https://tm-clkl.hk/eng/achievements\\_tmckl.html](https://tm-clkl.hk/eng/achievements_tmckl.html))



# Building Services Engineering

- Building Services Engineering (**BSE**)
  - It is about designing, installing & servicing everything that is needed to make buildings comfortable, safe & convenient
  - Concern with the design, manufacturing, installation, commissioning and maintenance of mechanical and electrical services in buildings

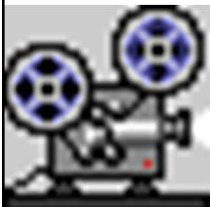
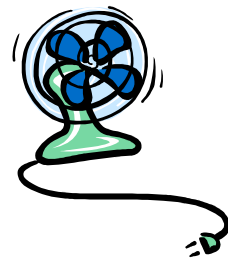

# Major Building Services Systems and Components

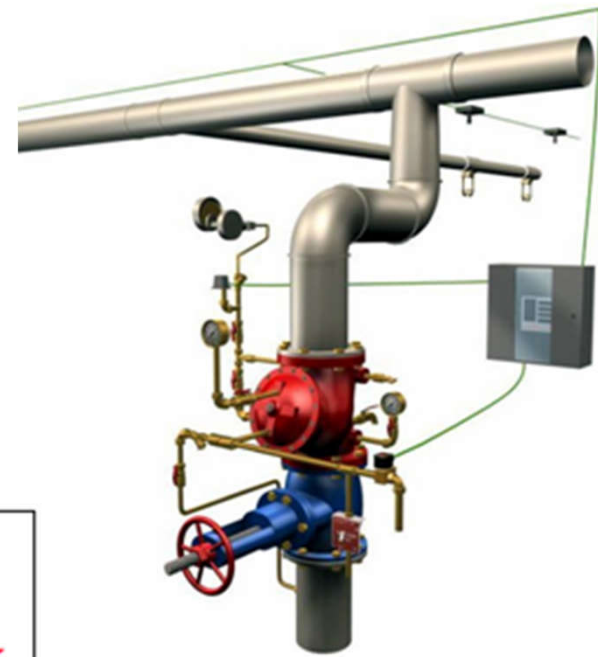

風 火  
水 電



More ...

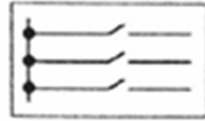

Electrical installation



Blinds and shutters



Ventilation



Air conditioning



Switchgear and controlgear

# Building Services Systems



Heating

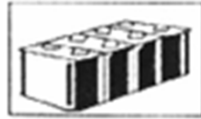

Stand-by power supply



Cooling



Elevator



Sanitation



Security



Lighting



Video



Waste disposal



Office and data systems technology

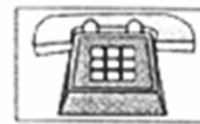

Telephone

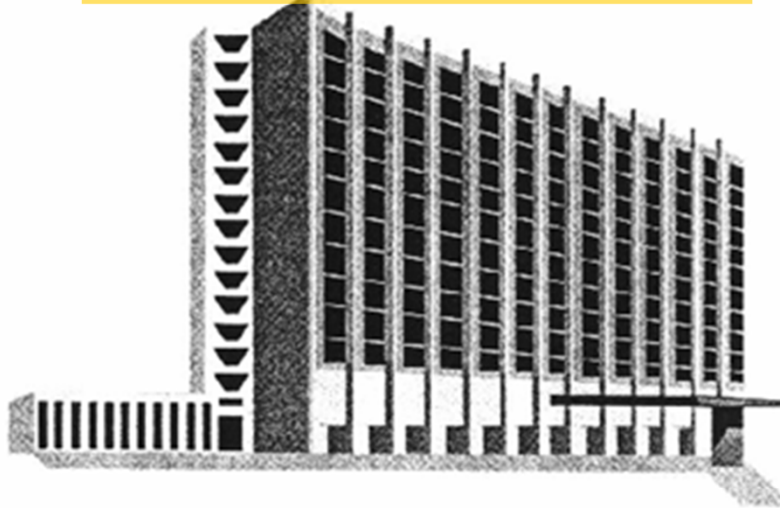

# Building Services Engineering

- Related areas/disciplines



- HVAC+R (heating, ventilating & air-conditioning + refrigeration)

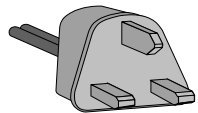

- Fire services

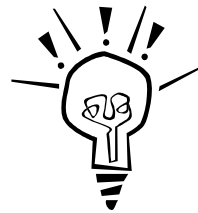

- Water supply & drainage



- Electrical services

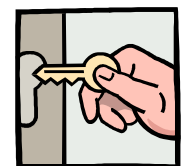

- Lighting systems

- Security & communication

- Lifts & escalators



# Building Services Engineering

- Related areas/disciplines (cont'd)
  - Building management & control system
  - Gas & steam supply
  - Acoustics and noise control
  - Facade engineering
  - Refuse disposal system
  - Building energy efficiency
  - Sustainable building design





# Every building requires Building Services



A ferry boat also needs Building Services.

# Airbus A380 also needs Building Services.

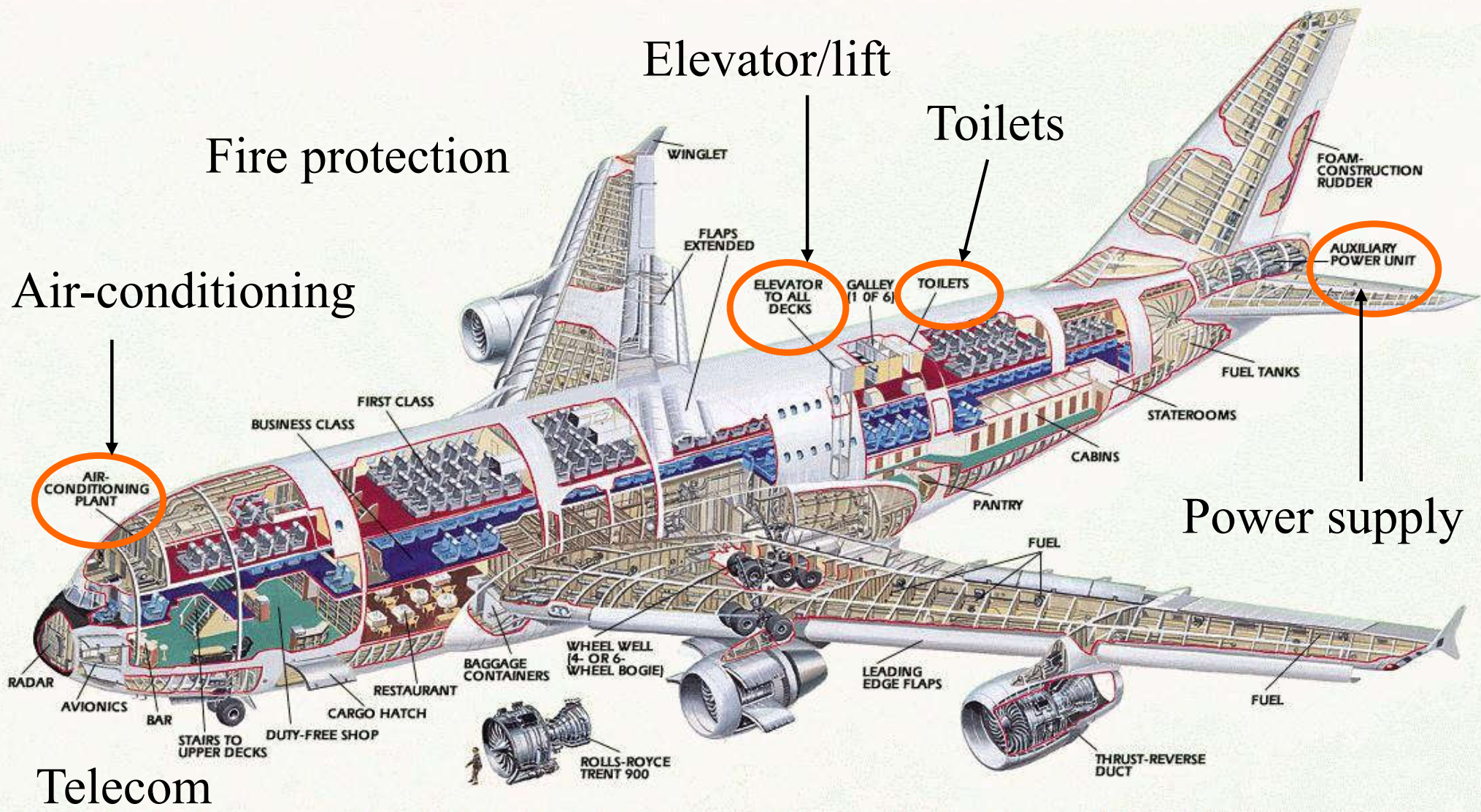

But they are not normal building services systems ...

An aerial photograph of Hong Kong, showing a dense urban landscape with numerous high-rise buildings and skyscrapers. The city is built on a hilly terrain, with the sea visible on the right side. The image is used as a background for the text.

Hong Kong 香港

**Why BSE are important to us?**

What will happen if no electricity, no water, no air-conditioning?



# Building Services Engineering

- Building & construction industry
  - An important sector in every society
  - Shape the built environment in which we live
- Building/Utility Services
  - Essential provisions for every building
    - Could account for 20-40% of total building cost
  - Affect people's comfort, health & productivity
  - Influence the building's performance, local & global environment (e.g. energy, water resources & air pollution)

# Building Systems

# Human Body

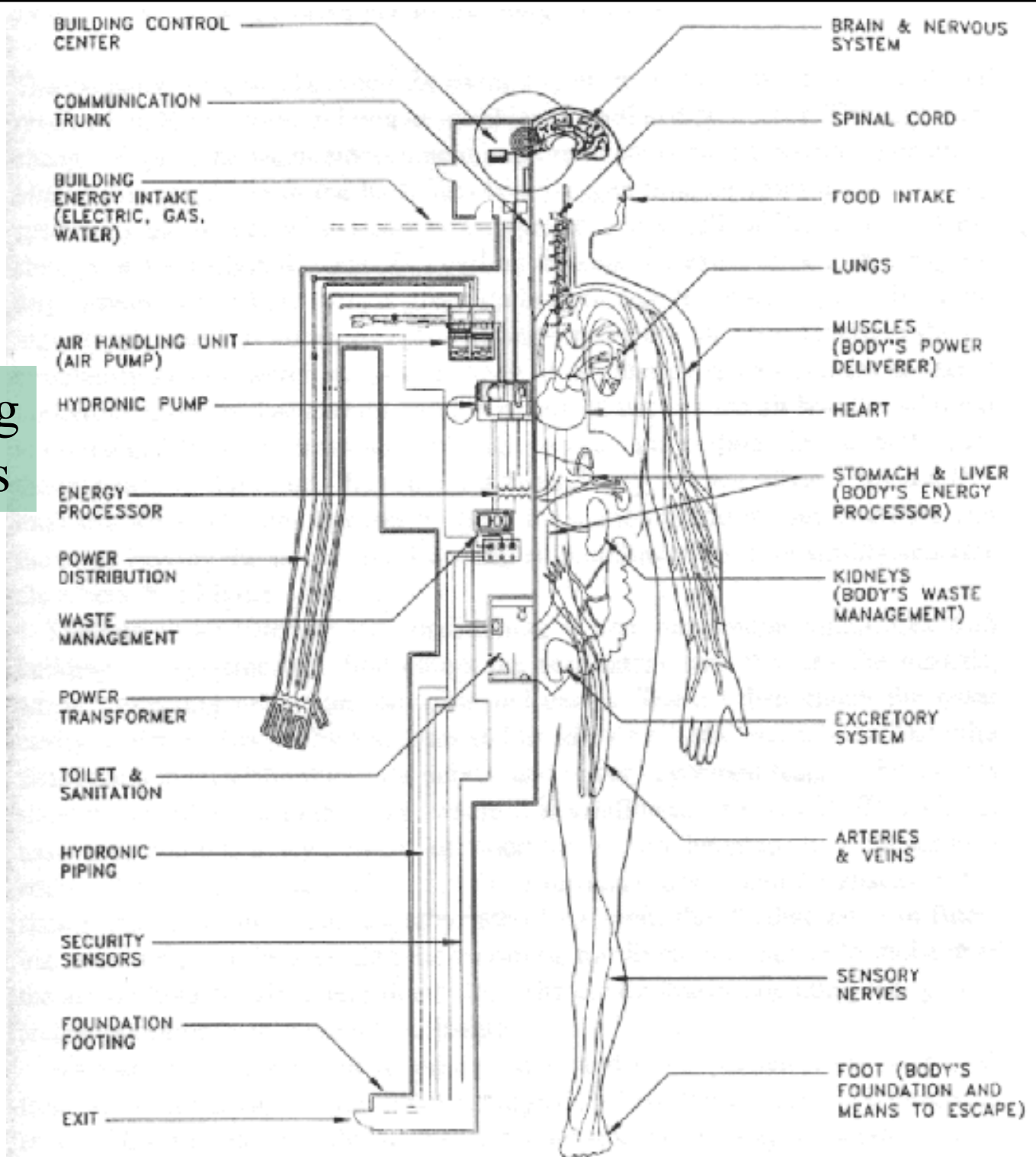

(Source: Ahuja, A., 1997. Integrated M/E Design: Building Systems Engineering, Chapman & Hall, New York.)

# Hong Kong's lead-in-drinking-water incidents 香港食水含鉛事件

## Water checks widen as more lead found

Amy Nip

The lead-in-water scare widened yesterday, with Wing Cheong Estate in Sham Shui Po becoming the latest victim.

The discovery comes as the Secretary for Transport and Housing Anthony Cheung Bing-leung announced that water checks are to be extended to another 12 public housing estates that were completed in 2011 and 2012.

"We have decided to expand the scope to all estates completed since 2011," Cheung said. "It involves an additional 12 estates comprising 35 blocks and 26,000 flats."

After lead in water was found at Kai Ching Estate in Kowloon City, Kwai Luen in Kwai Tsing and Shui Chuen O in Sha Tin, the govern-



Wing Cheong is the latest public estate dragged into the contaminated water scandal. SING TAO

contractor of Wing Cheong Estate and Golden Day Engineering was responsible for pipe works. The plumber was not named yesterday.

The companies are different to those responsible for the construction at Kai Ching and Kwai Luen. At Wing Cheong, water tanks have been arranged for each block and bottled water is provided for the vulnerable.

The 12 estates to have their water tested are Shin Ming, Tin Ching, Sha Tin Pass, Yan On, Choi Tak, Choi Fook, Yau Lai, Hung Hom, Tung Wui, Shek Kip Mei Estate, Lower Ngau Tau Kok and Un Chau.

Cheung said after tests at the additional 12 estates were completed, he would not rule out further extending the coverage of water tests to more public estates.

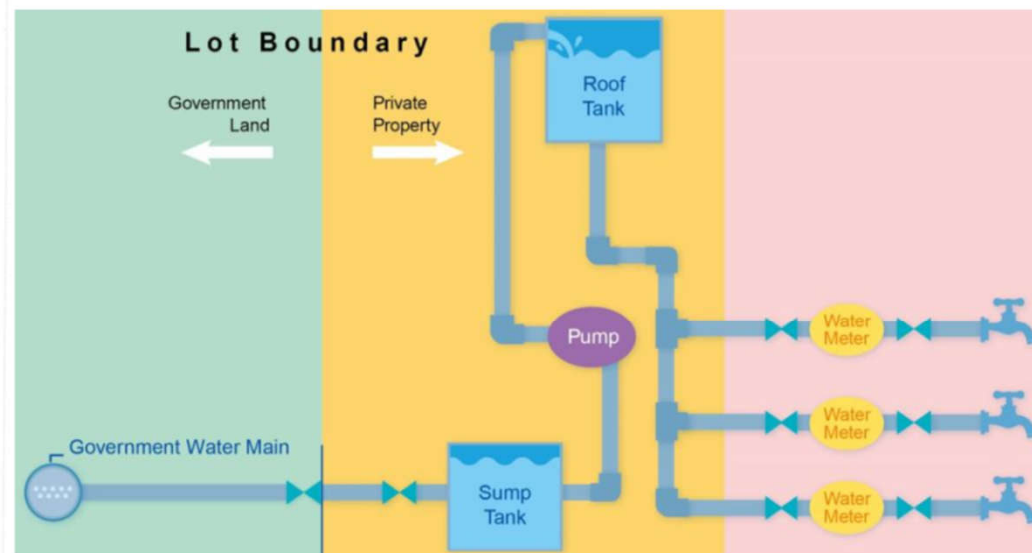
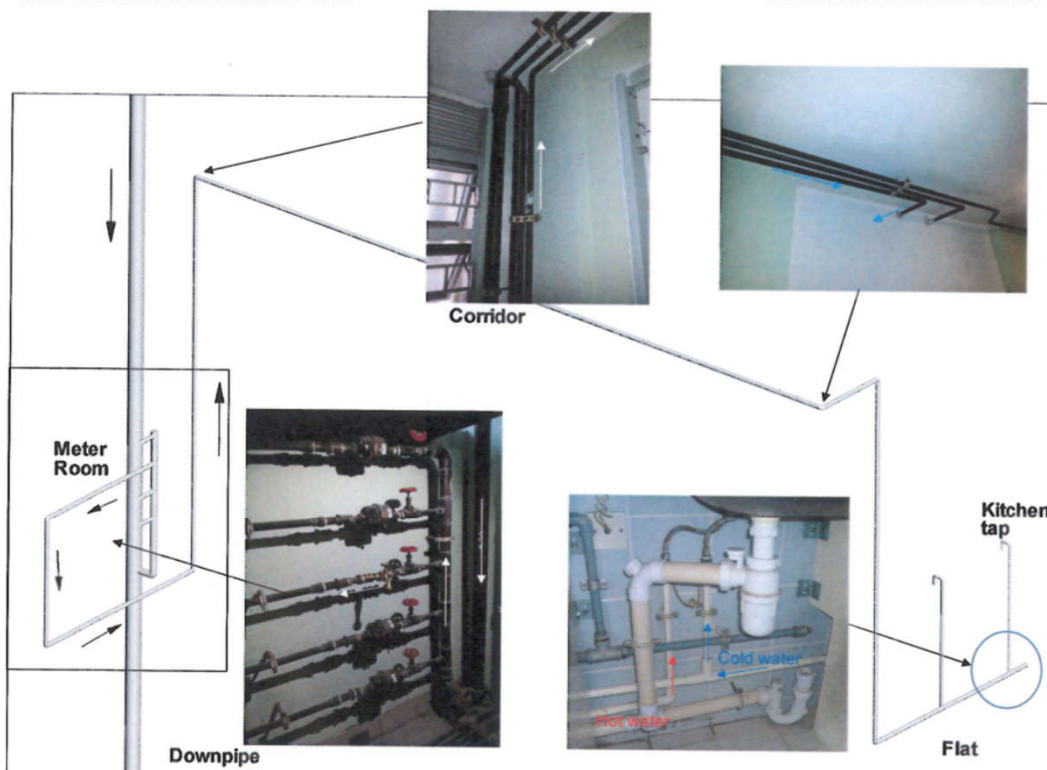

# Healthy building design & drainage system in response to COVID-19

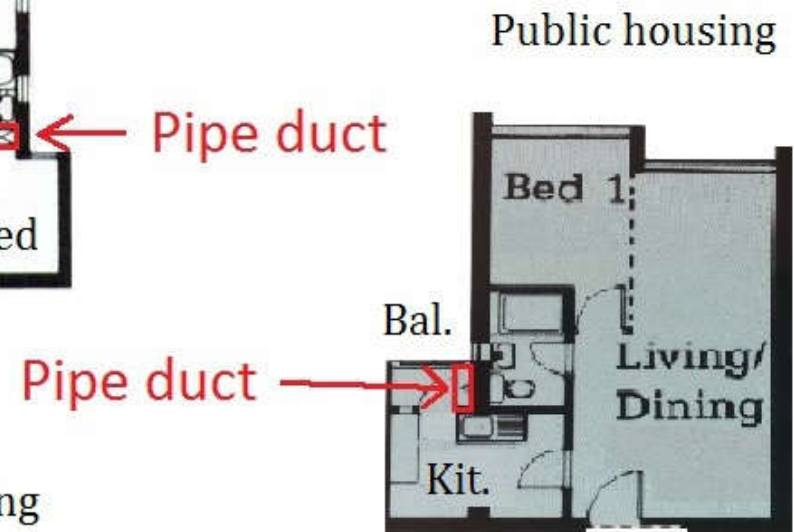
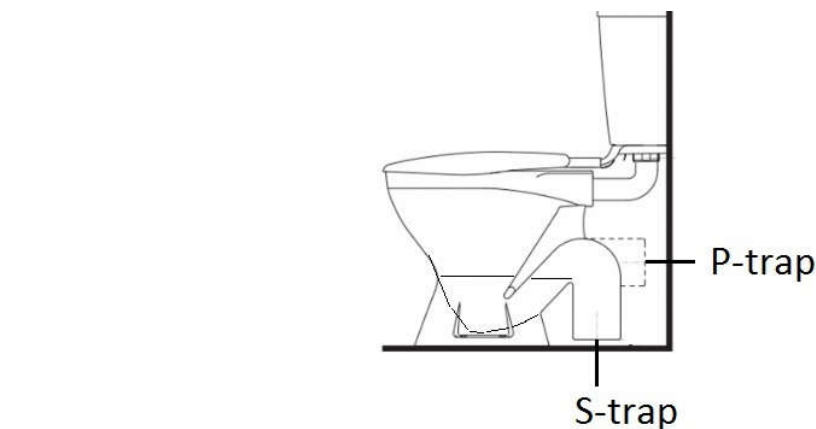
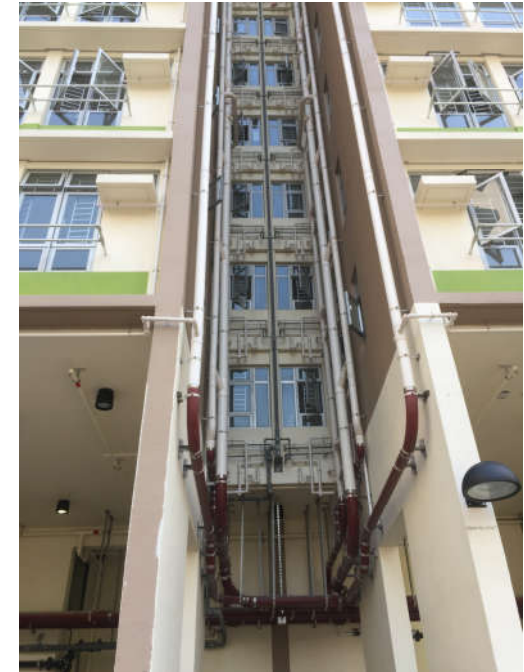
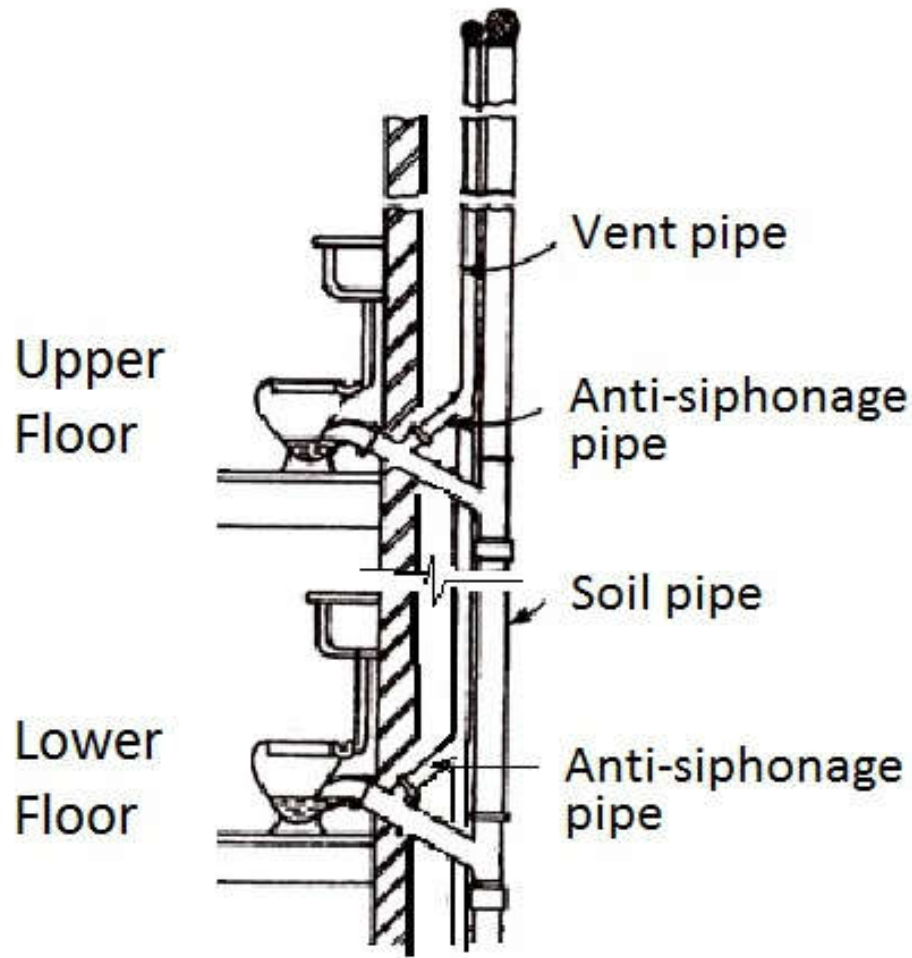

# 家居防疫 你我做到

LEAKY DRAIN BUSTERS  
渠漏  
解決師

「內防渠漏，外防滲透，抗疫同行」

安裝附有反虹吸功能的U型聚水器



每週灌注半公升的水至U型聚水器，以水封堵塞病毒進入。

檢查是否有安裝接駁座廁的排氣管，並且在任何情況下都不可移除排氣管。

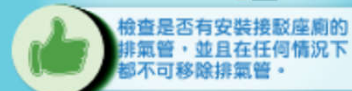

打開面向無阻擋的窗戶，引入較清潔的空氣



細菌/病毒經由座廁的不同破損或滲漏渠管部份進入



如地台去水的U型聚水器或座廁沒有了水封，細菌/病毒除了經由排水系統的運作推到室內，亦會通過抽氣扇的運行而引入。

廁所及廚房需保持通風

廚房須留門縫協助通風對流，廁所則可使用門縫，帶通風口的門或於門底設磚隙。



天井或存在污染了的空氣，盡量不要開啟天井的氣窗

以抽氣扇加強空氣流通



Leaky Drain Busters  
渠漏解決師

COVID-19 transmission  
affected by building  
drainage system &  
ventilation

(Source: <https://www.hkie-bsd.org/attachment/publication/publicationPdf/1618966328PIAO3.pdf>)



# 淘大花園E座 病毒可能傳播途徑



傳播方式	可能性
廁所污水渠系統	病者糞便或唾液經廁所水渠沖下時，病毒經通風管道傳至相連同一座向的其他單位
空氣	美國疾病控制及預防中心不排除此可能
飛沫	醫學界公認最有可能的傳播途徑，附在物件上的病毒至少可生存3小時
信箱	勞永樂醫生指7號和8號單位的信箱在同一直排，若同沾上帶病的口水或鼻涕，居民取信時可能感染
冷氣機滴水	勞永樂指可能性不大
晾衫滴水	勞永樂指可能性不大
食水喉	梁秉中教授指可能性不大

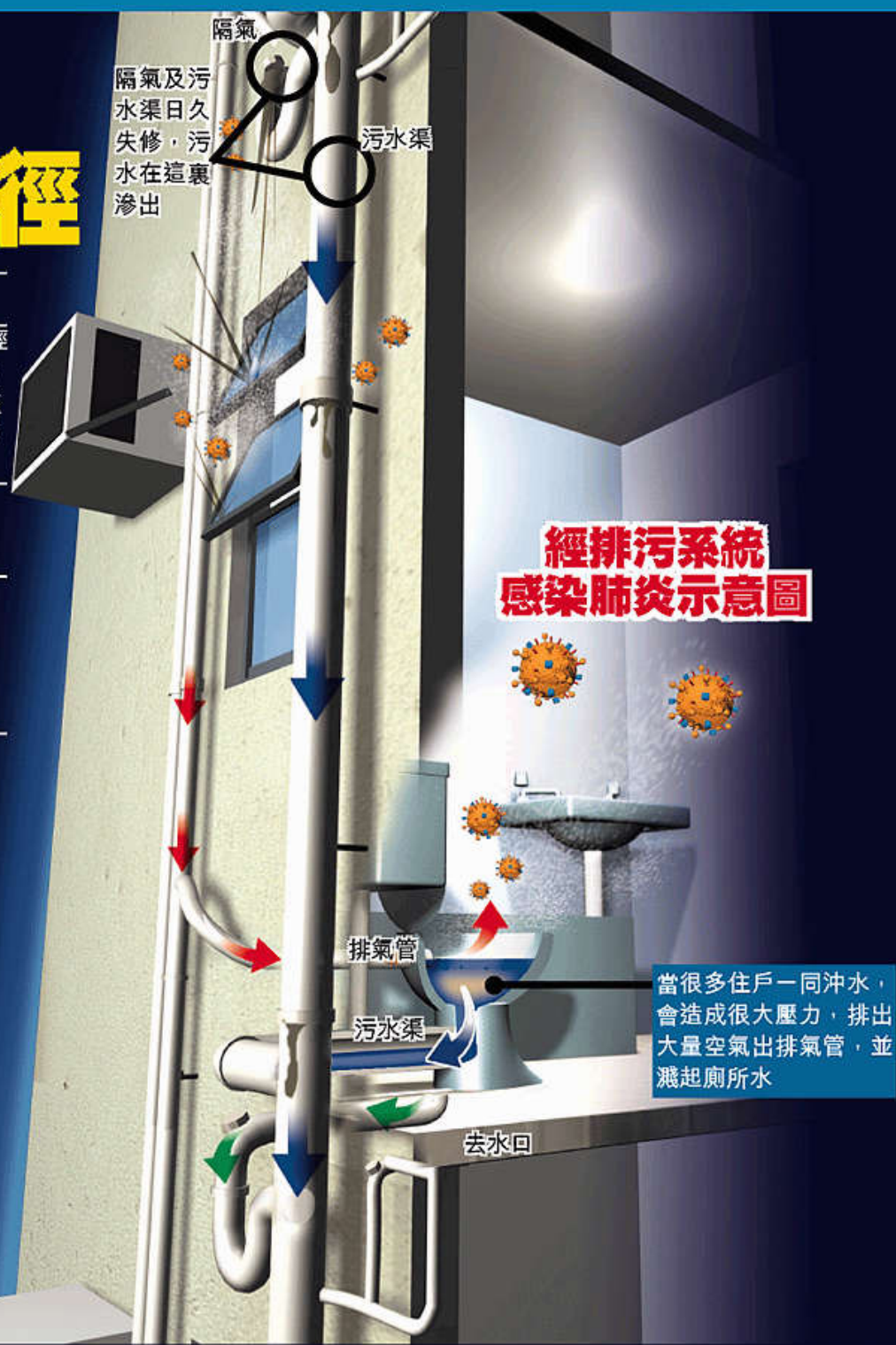

**經排污系統  
感染肺炎示意圖**

當很多住戶一同沖水，會造成很大壓力，排出大量空氣出排氣管，並濺起廁所水

資料來源：各受訪者及《蘋果》資料室

# 港大工程學院淘大調查結果

## 程序一：

「超級帶菌者」在浴室咳嗽噴嚏釋出污染體，並附於熱水浴產生的小水點；或沖廁污水在渠內撞擊導致病毒小水點倒流



## 程序二：

帶病毒小水點經抽氣扇進入天井並向上升，因8室較當風，8室單位住戶感染數目多於7室

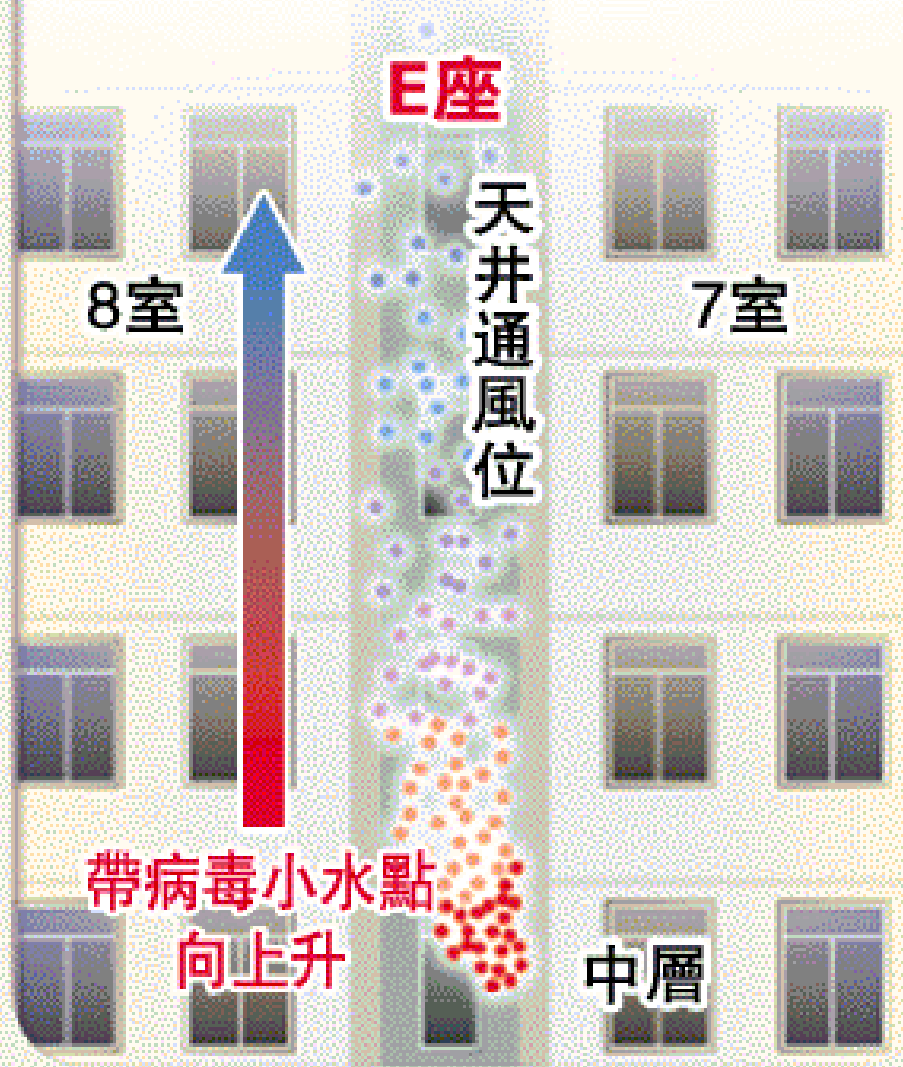

# Pressure and friction factor in a single stack drainage system

Apply engineering & scientific principles for the analysis

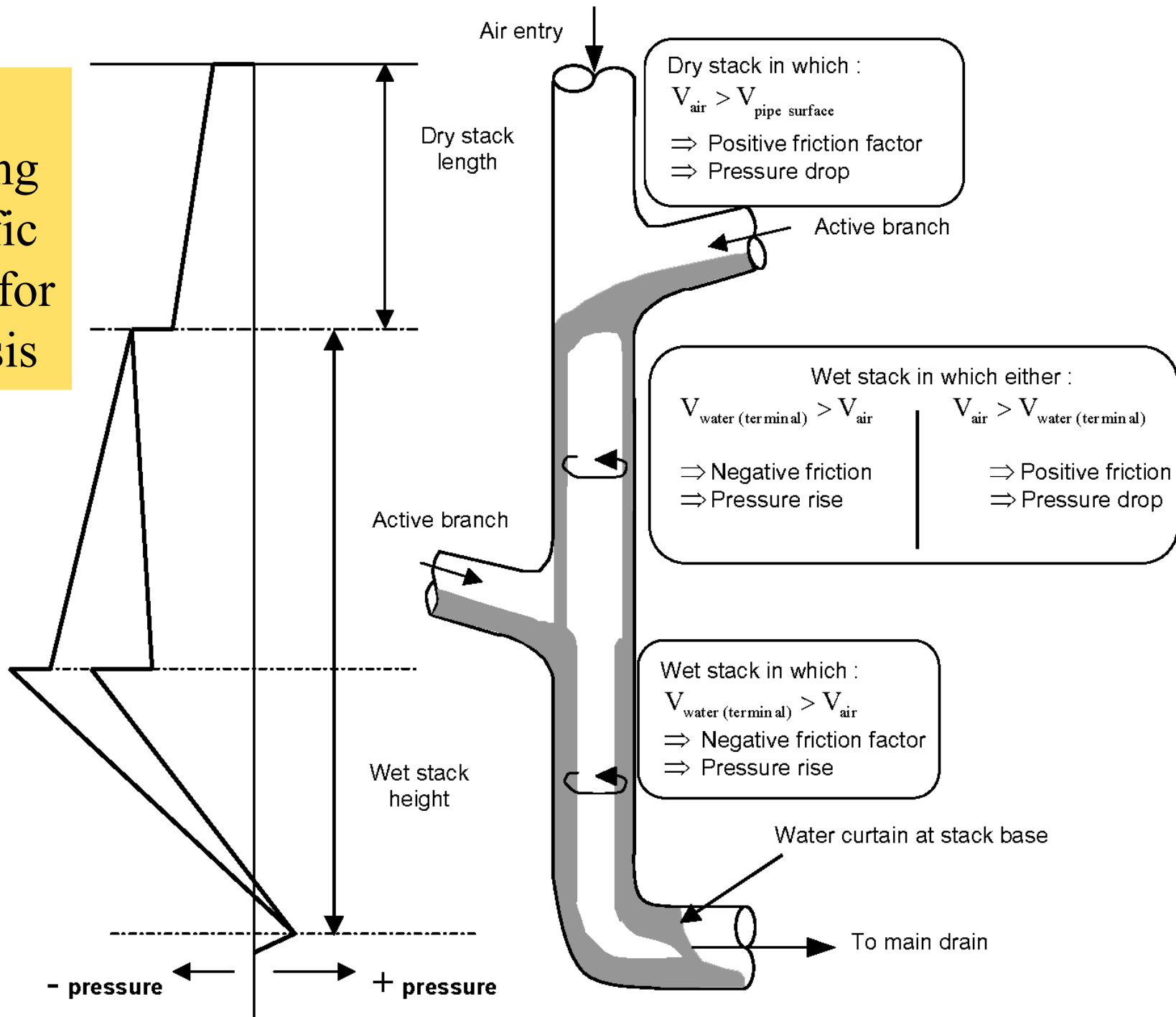

# Building Services Engineering

- Design practice and proper operation of utility services and BSE systems are very important

- Water supply and sanitation



- Well-designed and properly maintained to ensure healthy and sustainable buildings
- Prevent transmission of diseases, e.g. COVID-19
- Facilitate acceptable hygiene

- Steam, fuel gas, telecommunication, security



- Public health & safety
- Comfortable & convenient built environment

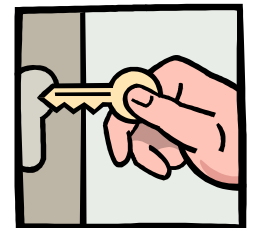
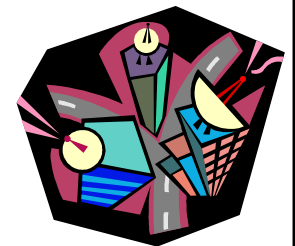

# Design & operation issues



- Main objectives of BSE design
  - Hygiene (prevent disease & ensure health)
  - Safety (protect against risks)
  - Comfort (physio- & psycho- well-beings)
  - Convenience (efficiency & productivity)

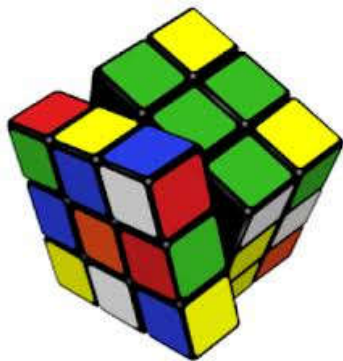

# Design & operation issues



- Design objectives and criteria

- Expected quality of service
- Reliability
- Costs \$\$\$



- Other considerations

- Environmental impact (local & global)
- Risk management
- Regulatory issues

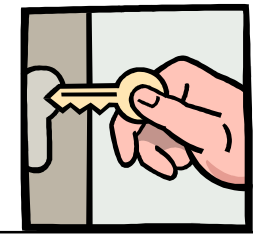
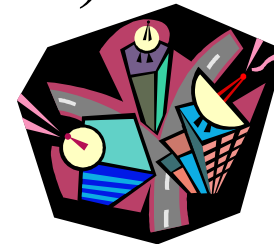

# Design & operation issues



- Important issues of BSE:
  - Energy efficiency in buildings
  - Indoor air quality
  - Intelligent buildings
  - Sustainable/green building
- Developments in Hong Kong:
  - The new Buildings Energy Efficiency Ordinance
  - Green building design and assessment
  - Need to control indoor air pollution



# Design & operation issues



- Environmental factors:
  - Climate & local resources (like water & energy)
  - Urban setting & site conditions
- Human factors:
  - Thermal, visual & acoustic comfort
  - Occupants' needs & behaviour
- Market factors:
  - Local practices & tradition
  - Government codes & regulations

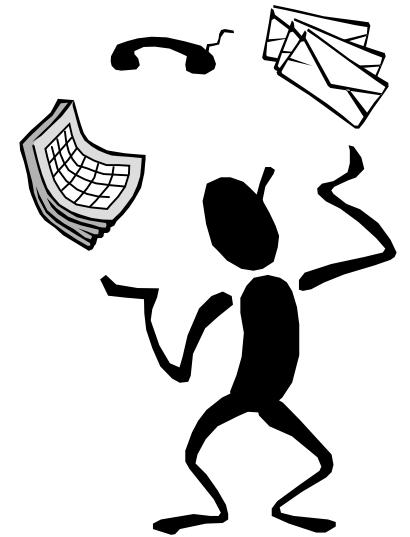



# Design & operation issues



- Three major elements:
  - Plant (e.g. pumps, transformers)
  - Distribution (e.g. pipes, ducts)
  - Terminals (e.g. fittings, outlets)
- Design information
  - Schematic diagrams
  - System layout
  - System selection & specification

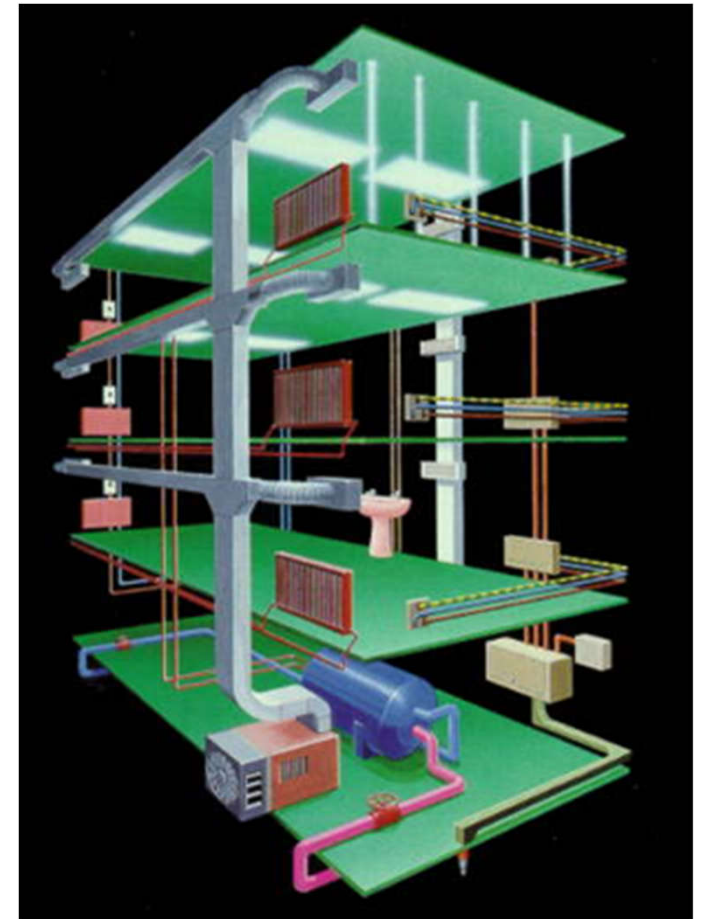

# Water treatment and supply process in Hong Kong

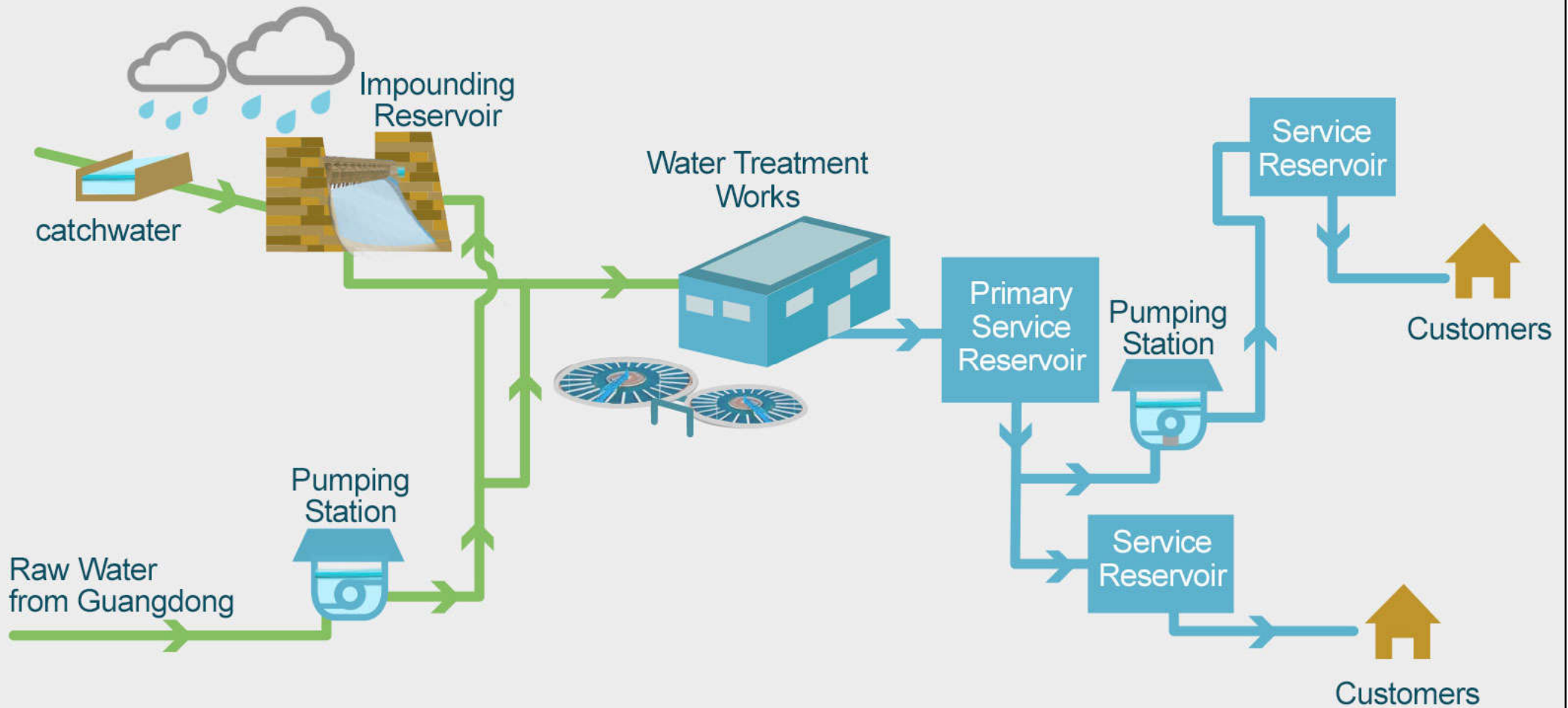

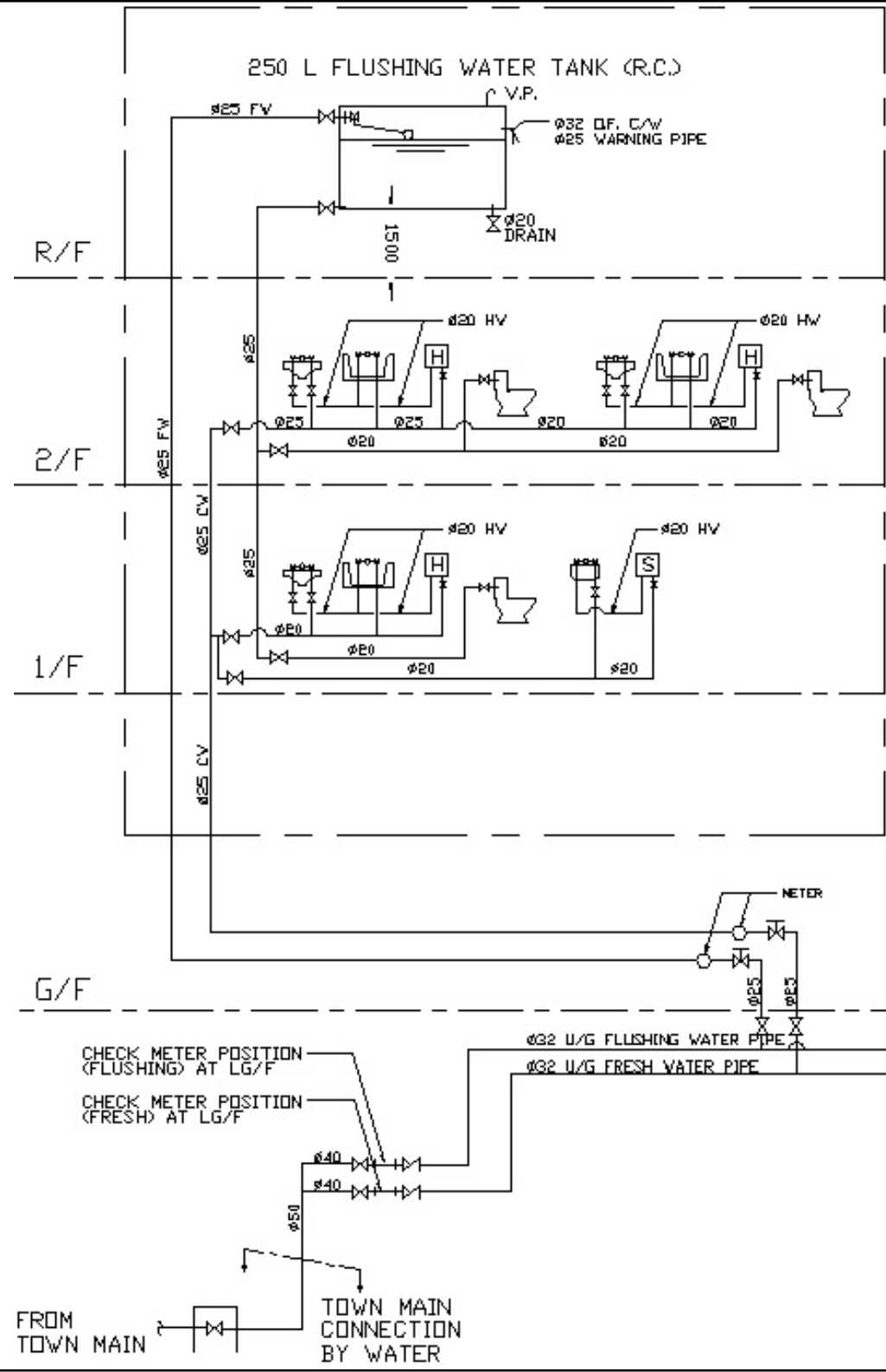

Example of a plumbing system schematic (fresh & flushing water supplies)

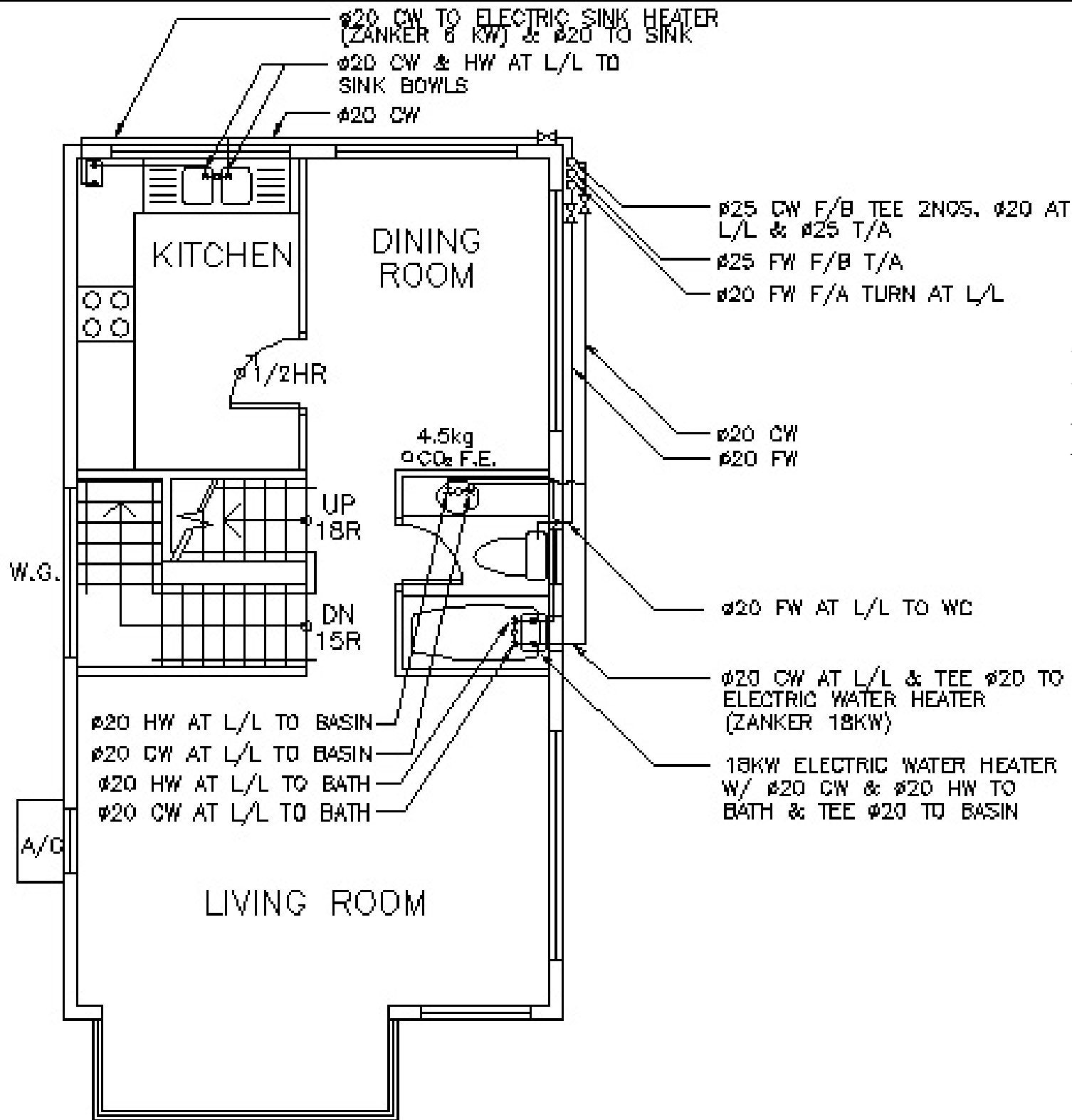

Example of plumbing layout design

# Schematic diagram of a flushing water supply system

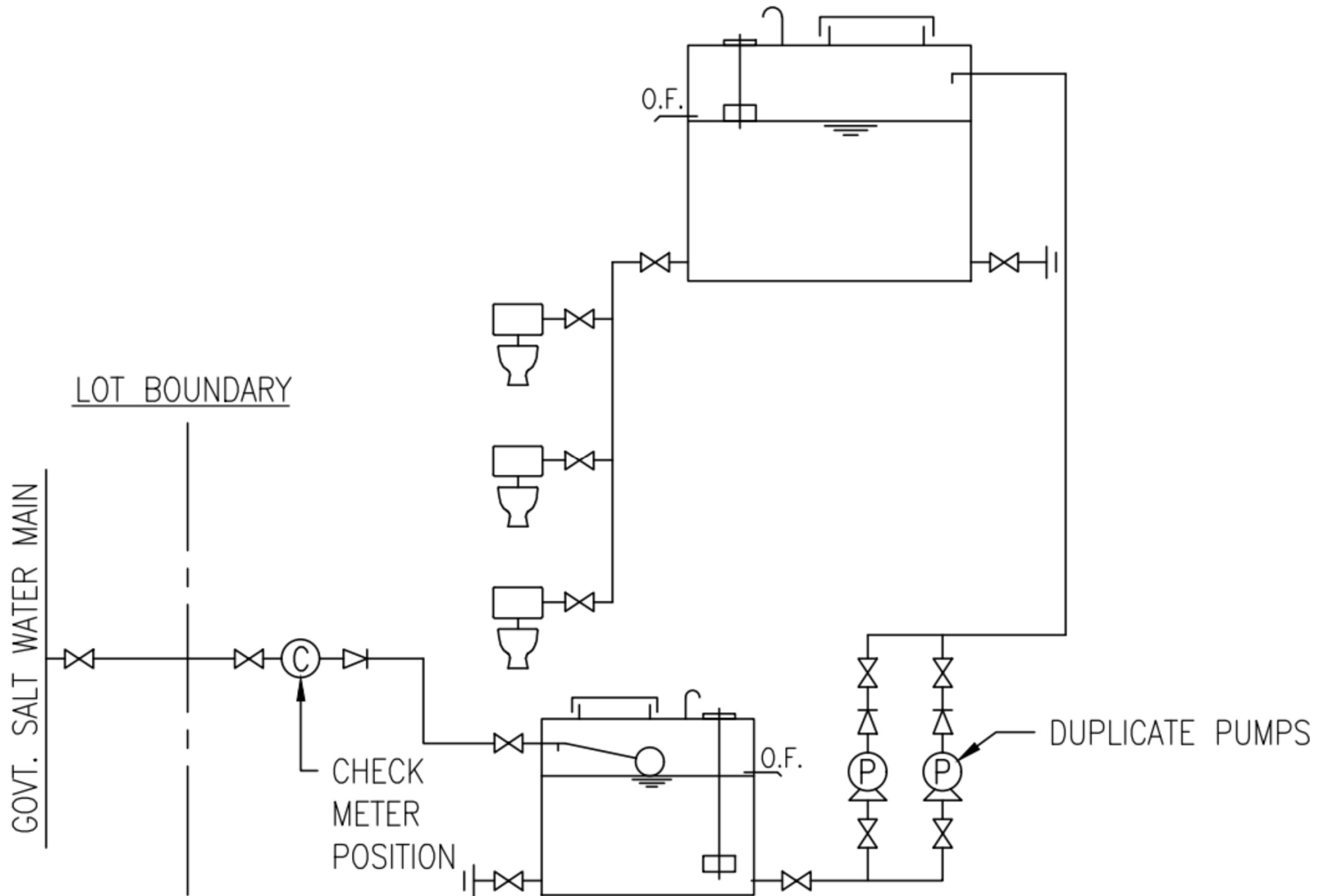

# Connection layout plan of a water supply system

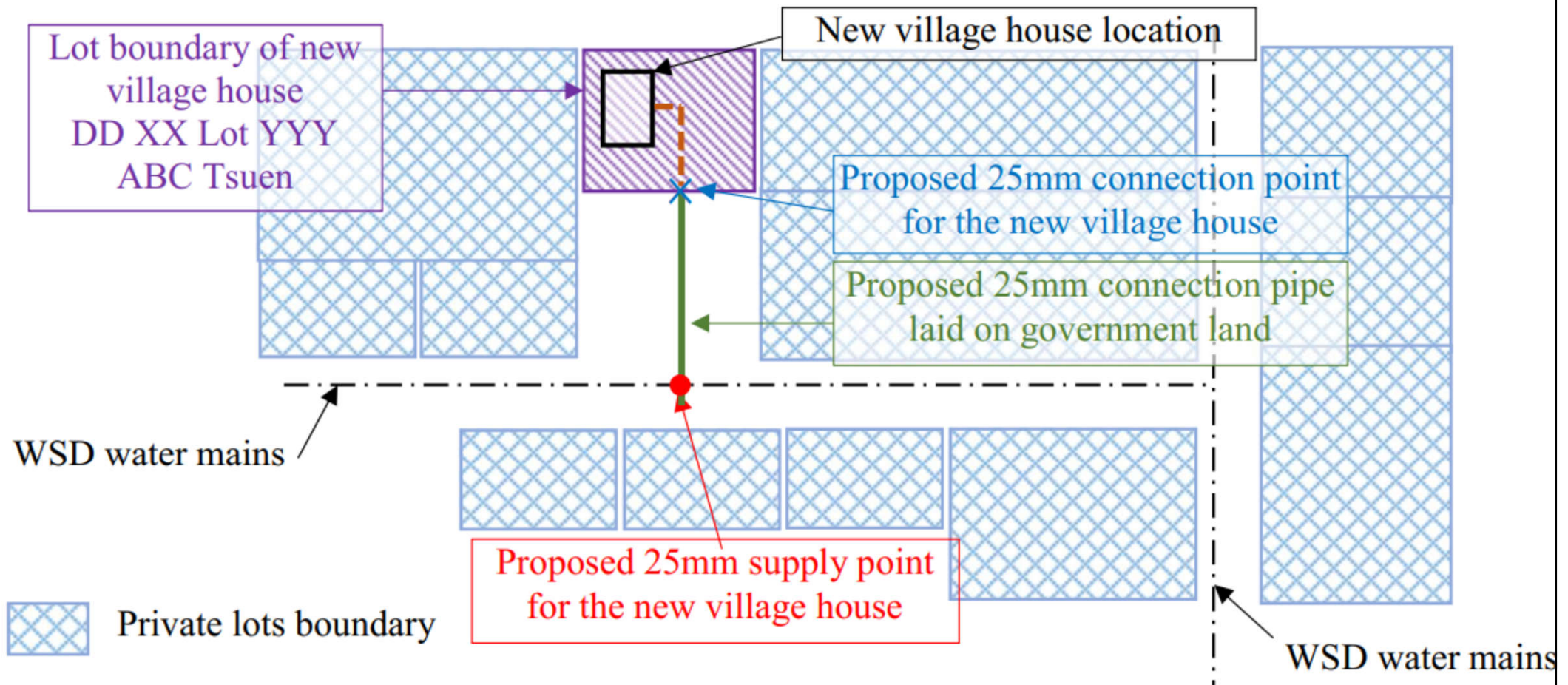

## Division of responsibilities on the maintenance of water supply systems

<b>Area of Responsibility</b>	<b>Maintained by</b>
Connexion to the main	Water Authority
Water meter	Water Authority (the Consumer/Agent is however responsible for the safe custody of the meter serving his/her premises)
Communal inside/fire service within the building/lot boundary	Agent (Landlord or Building Management)
Non-communal inside/fire service within the building/lot boundary	Consumer

# Schematic diagrams and design of building drainage systems

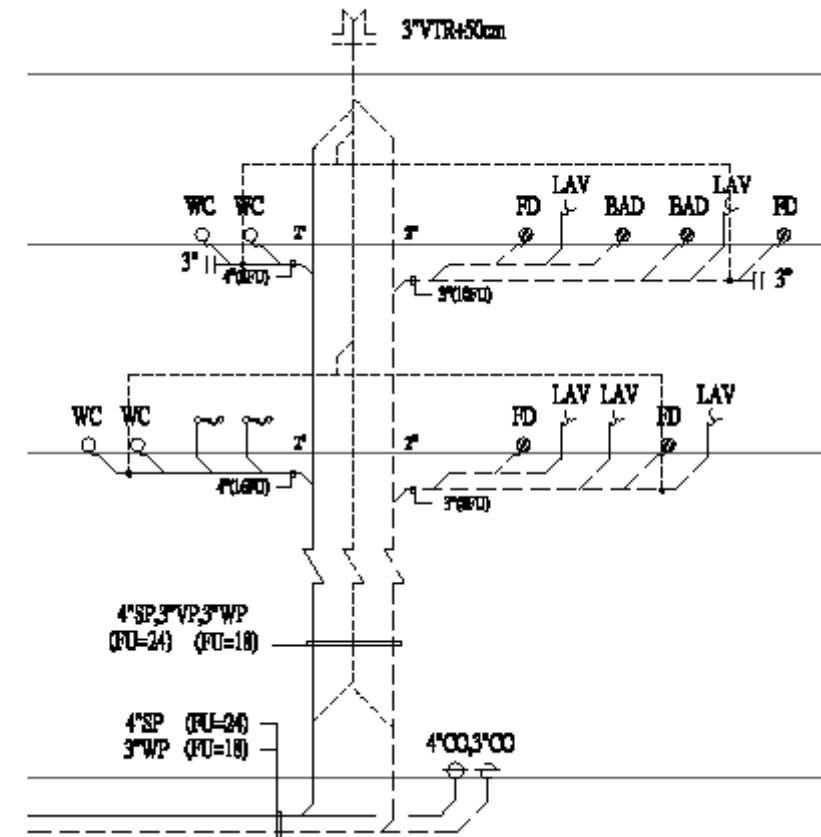
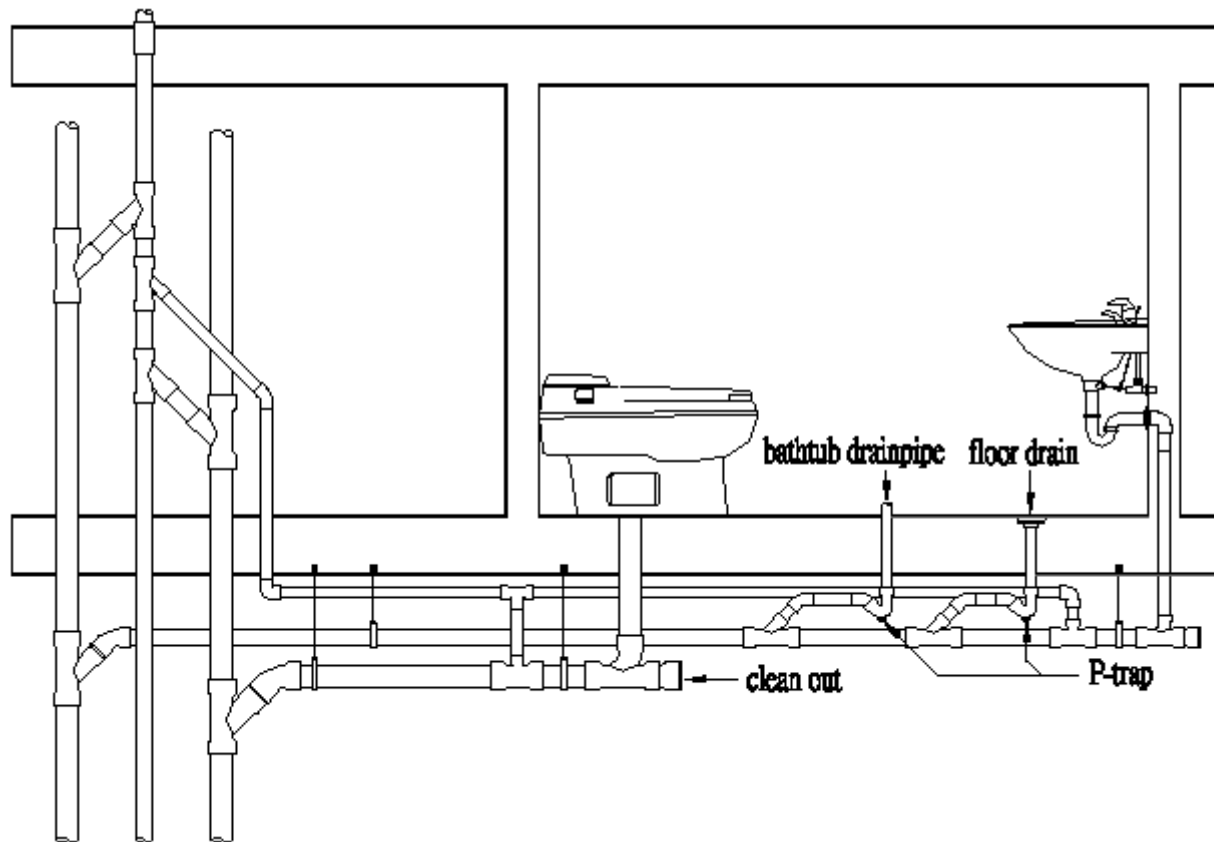
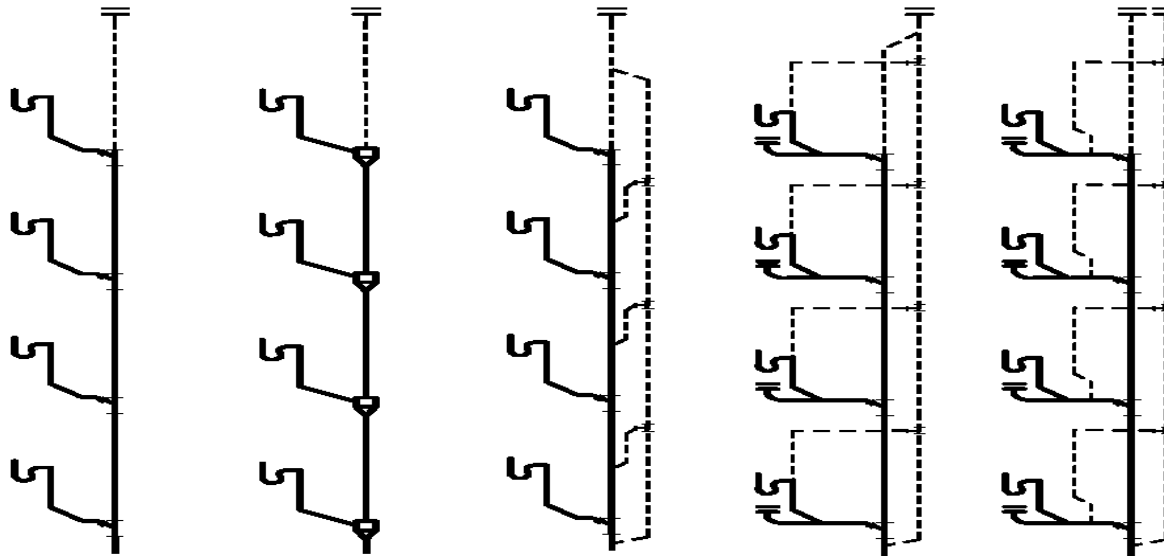

(Source: <https://www.irbnet.de/daten/iconda/CIB10559.pdf>)



# Building and construction process

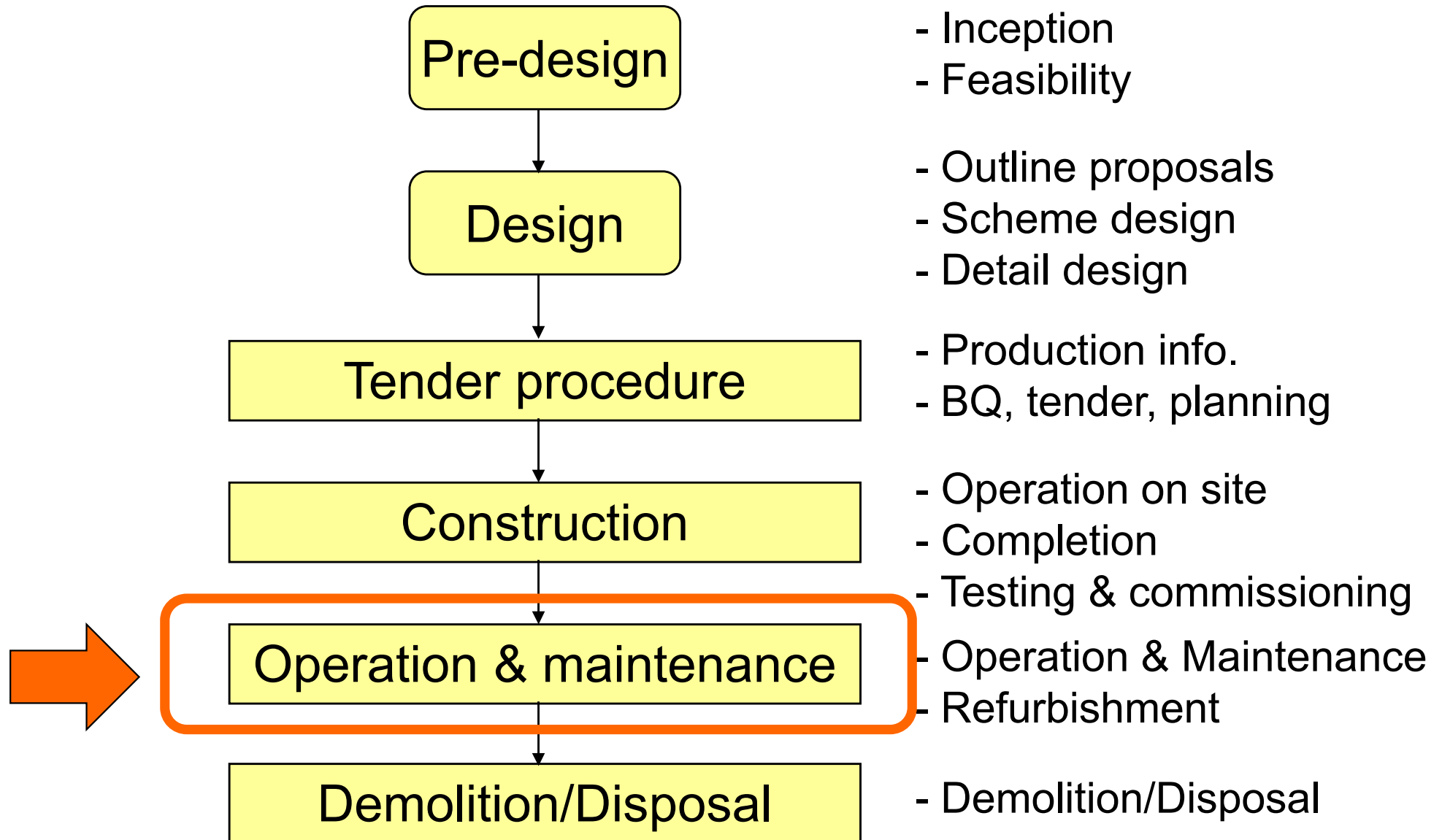

# Design & operation issues



- Operation and maintenance (O&M) of utility services and BSE systems
  - Important to assure the systems will perform the intended functions effectively
  - Affect a significant part of building life cycle costs
  - Closely related to facility management (FM) and asset management (AM)
- Defective systems & equipment will cause health risks & dangers to people



# Importance of operation and maintenance for building life cycle costs

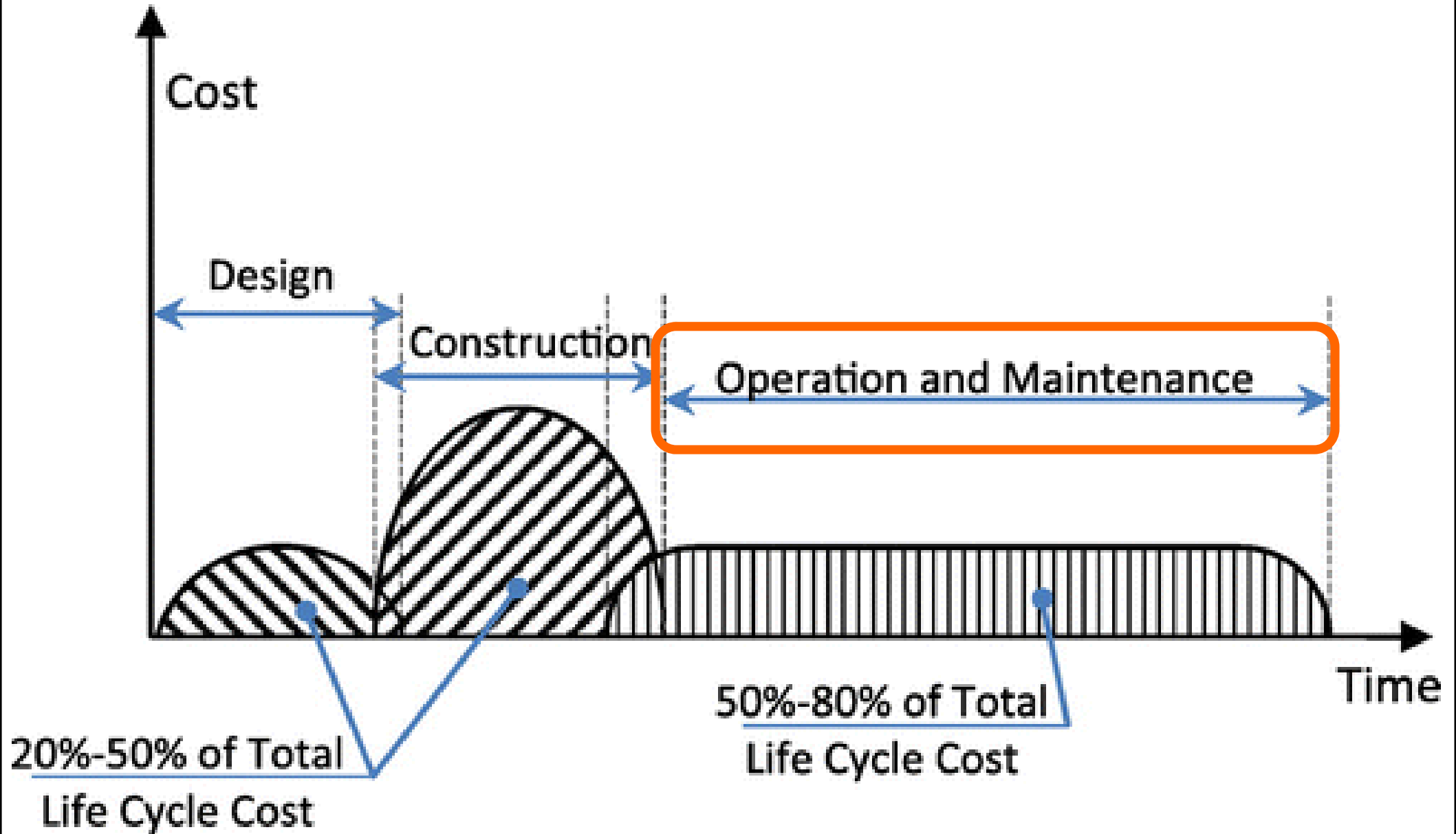

# Design & operation issues



- Defective drainage systems [https://www.bd.gov.hk/en/safety-inspection/building-safety/index\\_bsi\\_drainage.html](https://www.bd.gov.hk/en/safety-inspection/building-safety/index_bsi_drainage.html)
  - Important for a safe & healthy living environment
  - Regular inspection & proper maintenance
  - Drainage repair order (issued by Buildings Dept.)
  - Repair of drainage systems
    - Under the Minor Works Control System (MWCS)  
[https://www.bd.gov.hk/en/building-works/minor-works/minor-works-items/index\\_mwcs\\_items\\_c3a.html](https://www.bd.gov.hk/en/building-works/minor-works/minor-works-items/index_mwcs_items_c3a.html)
  - Common defects
    - <https://www.brplatform.org.hk/en/defects-and-orders/common-building-defects/defective-drainage-system>

# Examples and signs of drainage defects



Rusty external drainage pipes



Unauthorised alteration of drainage system



Leaking or broken drainage pipes at external wall



Rusty internal drainage pipes

# Traps and anti-siphonage pipes/air valves in drainage system

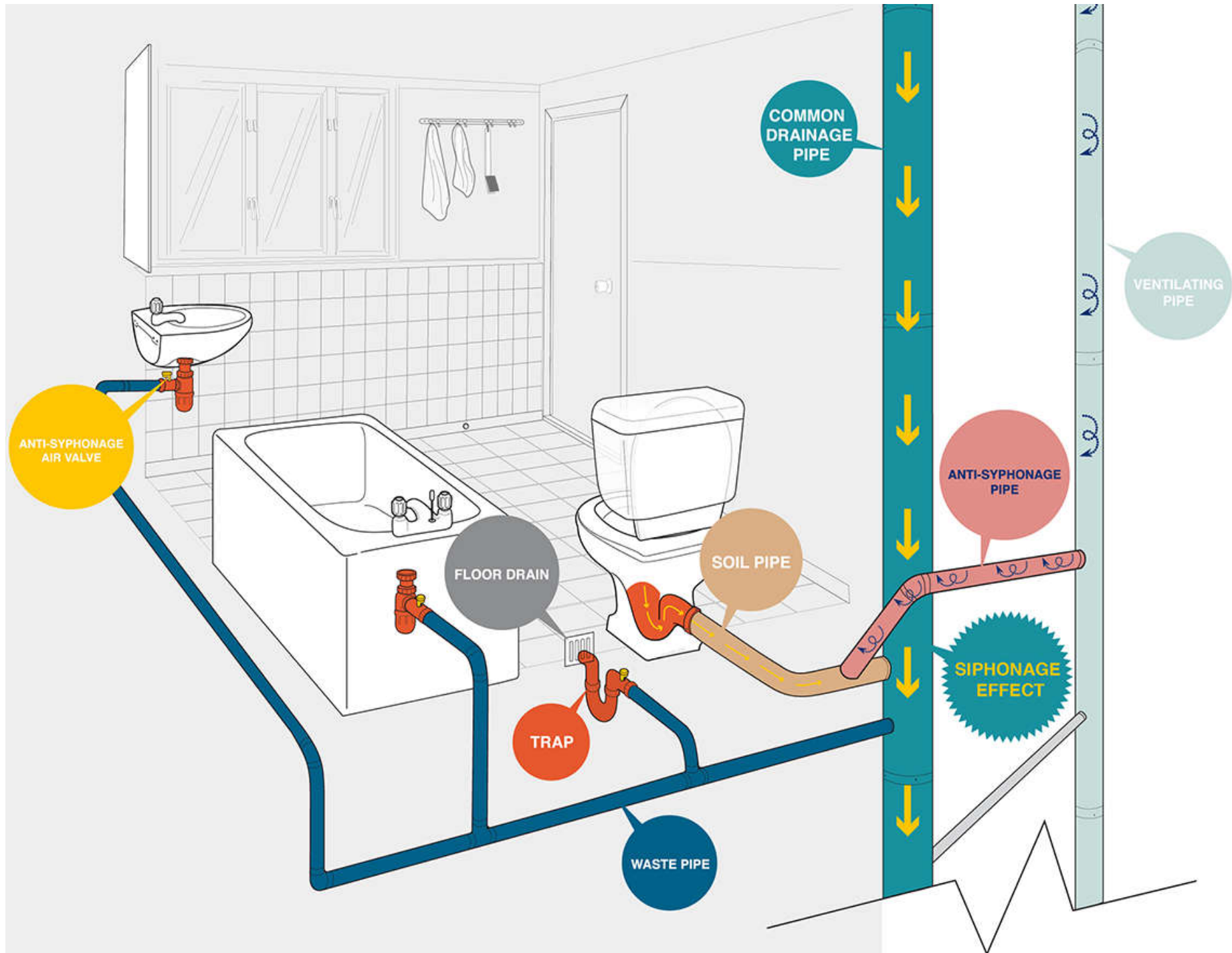

(Source: Buildings Department)



# Further Reading

- Hong Kong Planning Standards and Guidelines  
[https://www.pland.gov.hk/pland\\_en/tech\\_doc/hkpsg/](https://www.pland.gov.hk/pland_en/tech_doc/hkpsg/)
  - Chapter 7 Utility Services  
[https://www.pland.gov.hk/pland\\_en/tech\\_doc/hkpsg/full/pdf/ch7.pdf](https://www.pland.gov.hk/pland_en/tech_doc/hkpsg/full/pdf/ch7.pdf)
- Building services - Designing Buildings Wiki
  - [https://www.designingbuildings.co.uk/wiki/Building\\_services](https://www.designingbuildings.co.uk/wiki/Building_services)
- Building services engineer - Designing Buildings Wiki
  - [http://www.designingbuildings.co.uk/wiki/Building\\_services\\_engineer](http://www.designingbuildings.co.uk/wiki/Building_services_engineer)
- Types of building services - Designing Buildings Wiki
  - [https://www.designingbuildings.co.uk/wiki/Types\\_of\\_building\\_services](https://www.designingbuildings.co.uk/wiki/Types_of_building_services)
- Utilities' connections - Designing Buildings Wiki
  - [https://www.designingbuildings.co.uk/wiki/Utilities%27\\_connections](https://www.designingbuildings.co.uk/wiki/Utilities%27_connections)

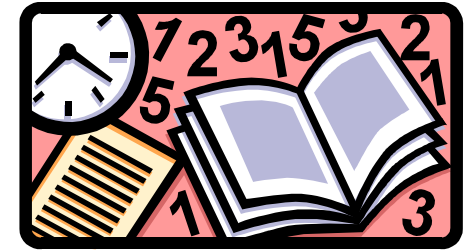

# References

- CIBSE, 2014. *Public Health and Plumbing Engineering*, CIBSE Guide G, Chartered Institution of Building Services Engineers (CIBSE), London.
- Hall F. & Greeno R., 2017. *Building Services Handbook*, 9th ed., Routledge, Oxon & New York.
- IOP, 2002. *Plumbing Engineering Services Design Guide*, [New ed.], Institute of Plumbing (IOP), Hornchurch, Essex, UK.
- Portman J. & Bleicher D., 2011. *Utility Connections and Diversions: Planning, design and installation*, BG 37/2011, Building Services Research and Information Association, Bracknell, Berkshire, England.
- UTI, 2011. *Guide to Utilities Management*, Utility Training Institute (UTI), Hong Kong. <http://www.hkius.org.hk/uploads/2/8/1/3/28134743/k.um.pdf>