

Design of Water Supply Systems



Ir Dr. Sam C. M. Hui

Department of Mechanical Engineering

The University of Hong Kong

E-mail: cmhui@hku.hk

Contents

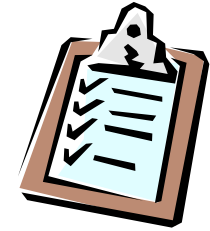

- Design considerations
- Water demand & storage
- Pipe sizing
- Pipe materials
- Pump systems



Design considerations

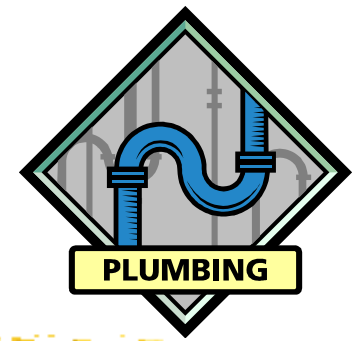

- Common water supply systems

- Cold water system
 - Potable/fresh water
 - Flushing (salt water in HK)
 - Cleansing water
 - Fire service
 - Swimming pool filtration
 - Irrigation (e.g. for landscape)
 - Fountain circulation
 - Air-conditioning water, etc.

We will focus on these

- Hot water system (e.g. in hotels & hospitals)

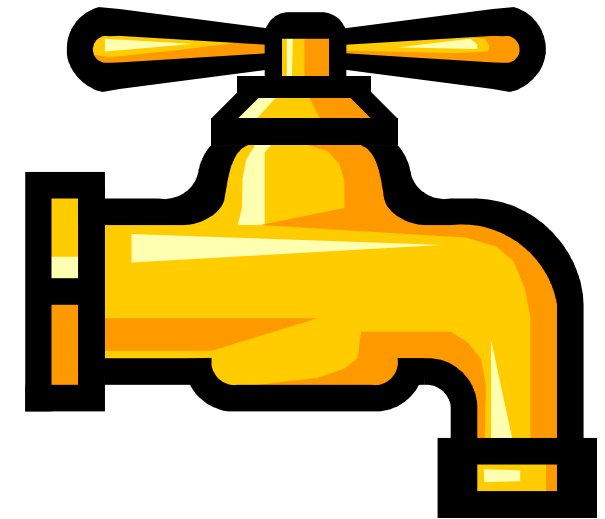

Design considerations

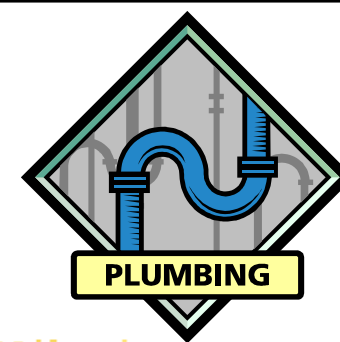

- Application for Water Supply in HK
<https://www.wsd.gov.hk/en/customer-services/application-for-water-supply/>



- Waterworks Ordinance (Cap. 102) (WWO)
- Water Supply for New Buildings
<https://www.wsd.gov.hk/en/customer-services/application-for-water-supply/water-supply-for-new-buildings/>
- Plumbing proposal, Form WWO 542 (apply for supply), Form WWO 46 (commence works)
- Licensed Plumbers (持牌水喉匠) & Registered Plumbing Workers (註冊水喉技工)

Guide to application for water supply

Submission Requirements at Proposal Stage

- Form WWO542, plumbing proposal with vertical plumbing line diagram (VPLD) & other drawings
- Replumbing works (refurbishment & replacement)
- For fresh water cooling towers
- For fire services
- For high draw-off rate non-domestic supply

Submission Requirements at Construction Stage

- Before commencement of works (Form WWO46 Parts I&II)
- Inspection stage (Form WWO46 Part IV)
- Issue Form WWO46 Part V(a) & (b) after inspection & water sampling tests
- Issue Form WWO1005

Application for Temporary Water Supply for Systematic Flushing

Application for Water Supply for Two-Storey Warehouse through One Stop Centre (OSC)

Provision of Sanitary Fitments and Fittings or Water Heaters in New Buildings

Random Inspection of New Plumbing Works during Construction Stage

Design considerations

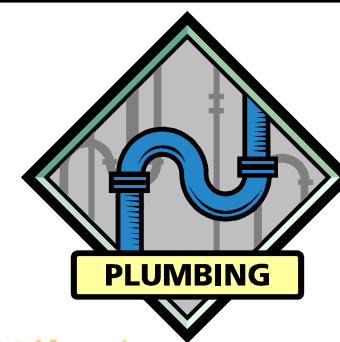

- Licensed Plumbers (持牌水喉匠)

- A person licensed under the Waterworks Ordinance to construct, install, maintain, alter, repair or remove water supply plumbing



- Grade I – for construction, installation, maintenance, alteration, repair or removal of a fire service or inside service of any type
- Grade II – for maintenance and repair of a fire service or inside service; and for installation, maintenance, repair or removal of water appliances



Design considerations



- General principles for installing plumbing works (from *WSD Plumbing Installation Handbook*)
 - All water fittings and pipework shall comply with the relevant Waterworks Regulations
 - All plumbing works shall be carried out in accordance with the Hong Kong Waterworks Requirements and by a licensed plumber
 - System main pipes should preferably not be run through the individual premises
- Also, Building (Standards of Sanitary Fitments, Plumbing, Drainage Works and Latrine) Regulations
<https://www.elegislation.gov.hk/hk/cap123I>

Essential aspects of plumbing design in new buildings

Example: Connection details (Fresh and Flushing Water Supply)

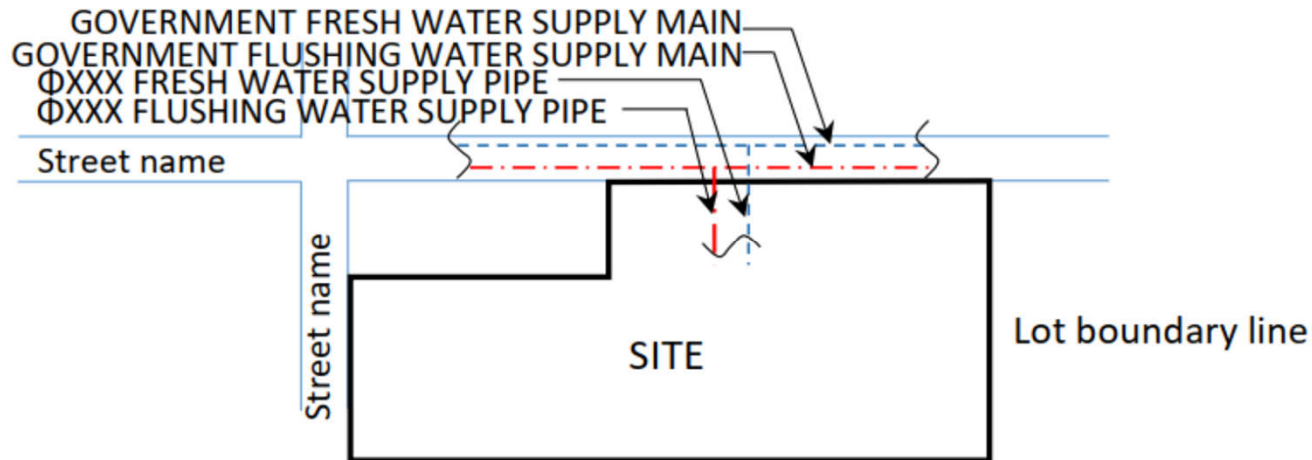

Example: Connection details (Fire Service Supply)

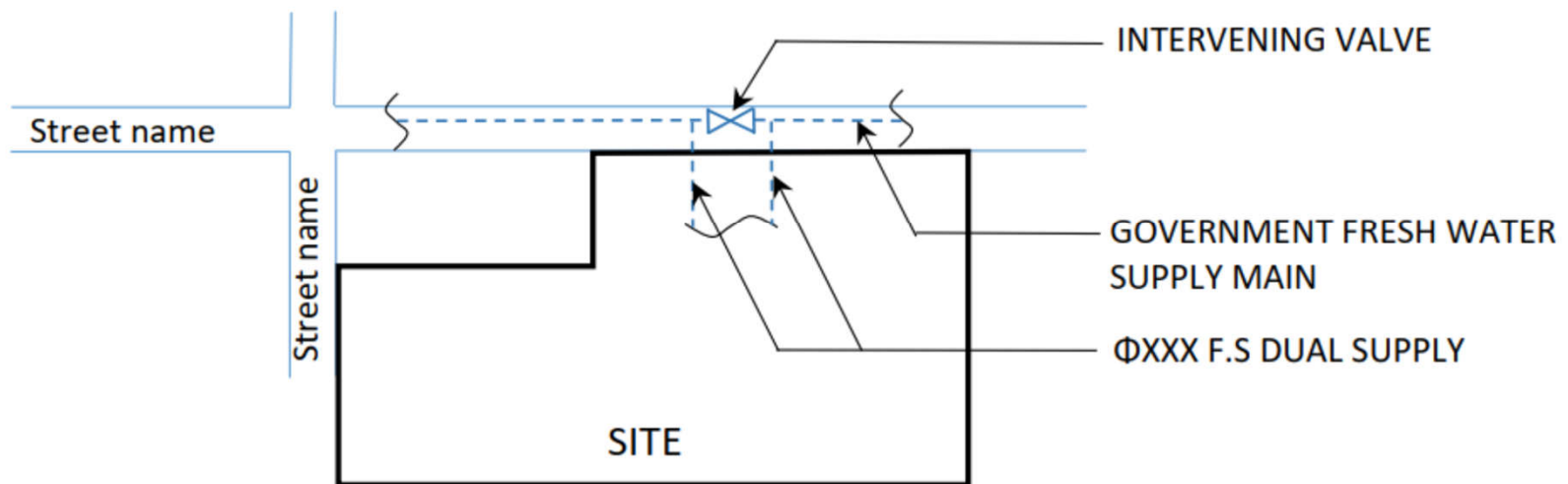

Typical configuration of master meter (MM) and sub-meter (SM) chambers in multiple-block development

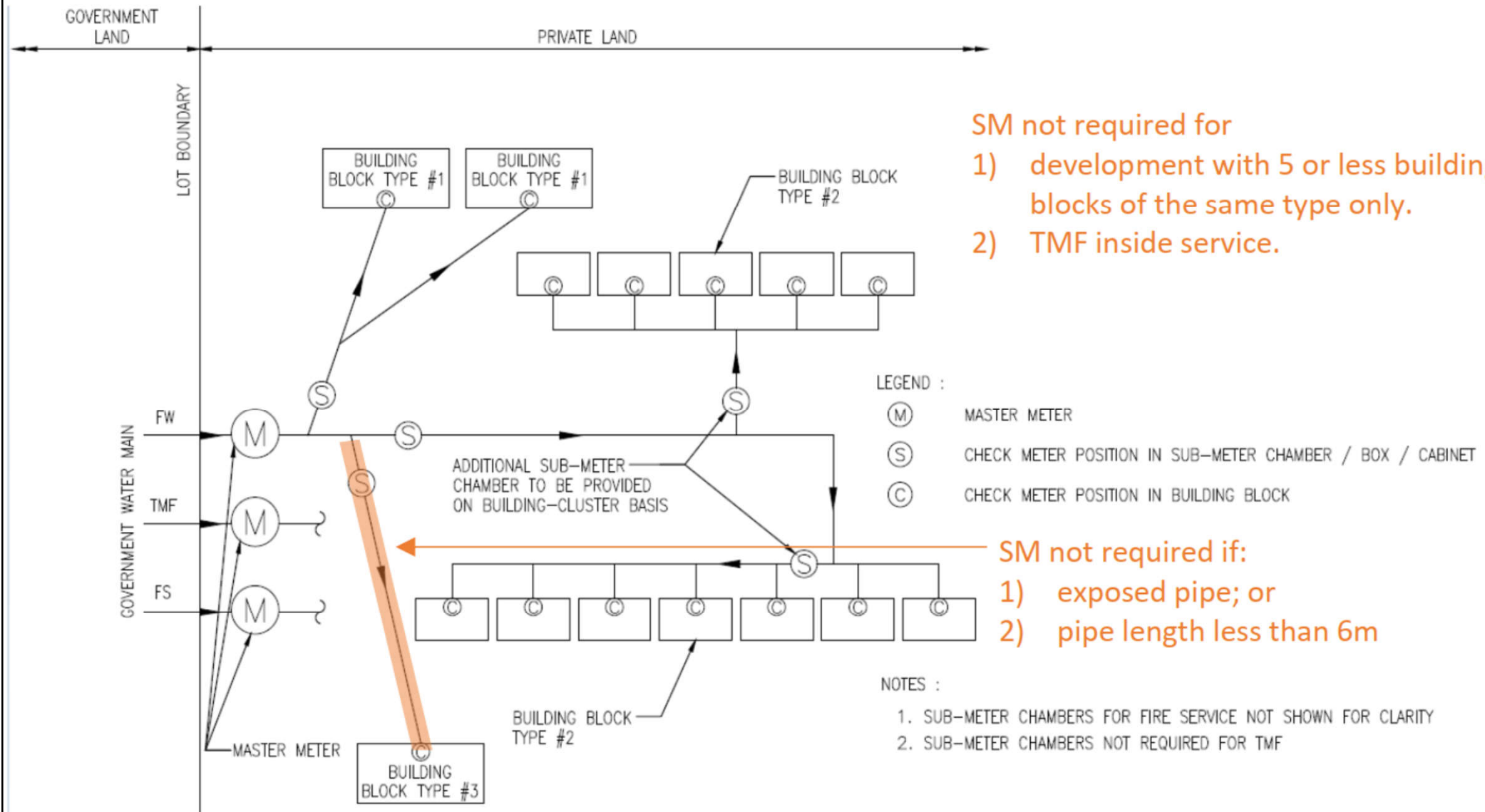

FW: Fresh water; TMF: Temporary mains fresh water for flushing; FS: fire service

Design considerations



- Plumbing proposal (vetted by WSD)
 - A block plan in a scale of 1:1000 showing the location and boundary of the development
 - The locations should be marked with datum level
 - A plan showing the alignment and size of the proposed connection pipes from the main to the development
 - A plan showing the proposed alignment and size of the internal underground water pipes to be laid in the development
 - Vertical plumbing line (VPL) diagrams



Design considerations



- Plumbing proposal (cont'd)
 - A schedule containing the following items :-
 - (a) number of flats/units in each block of the building
 - (b) address of each premise needs individually metered water supply
 - (c) number of draw-off points and sanitary fittings in each unit
 - (d) estimated daily consumption for all trade purposes
 - Meters arranged in meter rooms & fittings at the meter positions
 - The relevant standards for the pipe materials to be used
 - Capacities of the water storage tanks e.g. roof storage tanks

Design considerations



- Back siphonage & back pressure
 - Occur when water mains pressure reduces greatly
 - Contamination of water may happen
 - Contamination might also occur due to gravity & backpressure backflow
 - Anti-siphonage device and design precautions
- Backflow/Cross-connection prevention
 - Such as break tank, check valve, non-return valve, anti-vacuum valve, backflow preventer

Properties of common backflow prevention devices

Backflow prevention device	Applicable Cross-connection hazard rating as in AS/NZS 3500.1:2015	Corresponding Fluid category as in BS EN 1717:2000	Protection against back-pressure	Protection against back-syphonage
Break tank	High/ medium/ low	4-5	Yes	Yes
Backflow preventer/ Reduced Pressure Zone (RPZ) Device	High/ medium/ low	4	Yes	Yes
Check valve/ Non-return valve	Low	2	Yes	Yes
Double check valve (in series)*	Low	2	Yes	Yes
Anti-vacuum valve	Low	2	No	Yes

* For flushing meters stipulated in WSD Circular Letter No. 6/2017, Annex II, Village Houses.

(Source: WSD, 2020. *Technical Requirements for Plumbing Works in Buildings (November 2020 version)*, Water Supplies Department (WSD), Hong Kong. <https://www.wsd.gov.hk/en/plumbing-engineering/requirements-for-plumbing-installation/technical-requirements-for-plumbing-works-in-bldgs/>)

Design considerations



- Noise & vibration
 - Pipe noise
 - Pipe should not be fixed rigidly to lightweight panels
 - Flow noise
 - Keep velocities under control
 - Pump noise
 - Use rubber hose isolators, resilient inserts, acoustic filters

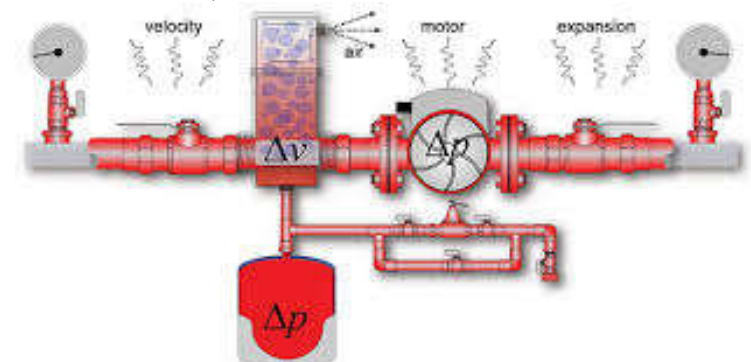
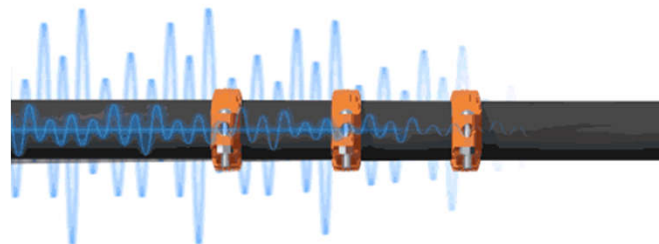
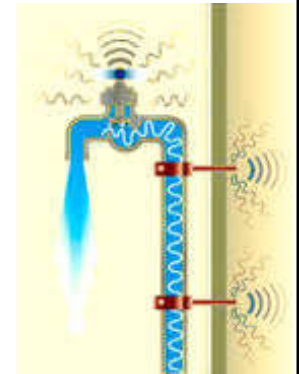

Design considerations



- Water hammer (水錘作用)
 - Such as when a valve is closed rapidly
 - Pulsating type of noise by shock waves
 - Preventive measures:
 - Prevent sudden closing of the valve
 - Absorb pressure peaks (e.g. by pneumatic vessels)
 - Increase the attenuation of pressure waves when transmitted through the pipework
 - Design the pipework to avoid long straight pipe runs
 - Restrict water velocities (e.g. to a maximum of 3 m/s)



What is Water Hammer?

1 Valve closed - water still



2 Valve open - moving water



3 Valve closes - **WATER HAMMER**

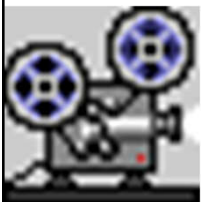

Video: What is Water Hammer? | DFT Inc. (2:38) <https://youtu.be/6ydsAIHWVNM>

(Source: <https://www.pannhomeservices.com/what-is-water-hammer-and-how-can-i-stop-it/>)

Design considerations



- Water conservation & energy efficiency
 - Water conservation
 - A key factor in the design (to conserve water)
 - Measures:
 - Detect water leakage
 - Reduce water consumption
 - Reuse or recycle water
 - Energy efficiency
 - Adopt pumps of better energy efficiency
 - Insulation of hot water pipe, fittings & vessels
 - Use of fresh water for cooling tower make-up



Design considerations



- Major tasks of water systems design:
 - 1. Assessment & estimation of demands
 - 2. Supply scheme & schematic
 - 3. Water storage requirements
 - 4. Piping layout
 - 5. Pipe sizing
 - 6. Pipe & fitting materials
 - 7. Pump system design

Water demand & storage



- Water demand depends on:
 - Type of building & its function
 - Number of occupants, permanent or transitional
 - Requirement for fire protection systems
 - Landscape & water features
- Typical appliances using the cold water
 - WC cistern, wash basin, bath, shower, sink
 - Washing machine, dishwasher
 - Urinal flushing cistern

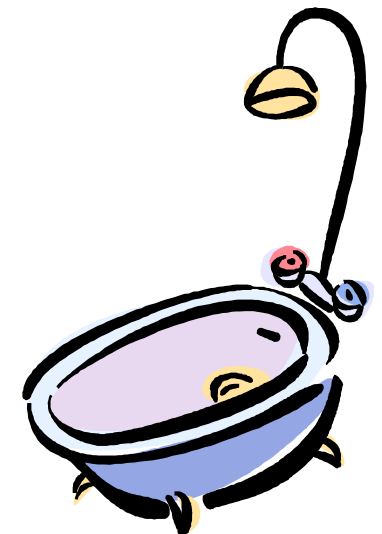

Water demand & storage



- Theoretical framework: Probability Theory
 - Based on statistics & a binomial distribution*

$$P_m = \left(\frac{n!}{m!(n-m)!} \right) \times P^m (1-P)^{n-m}$$

Binomial coefficient
(different ways of distributing m successes in a sequence of n trials)

- P_m = probability of occurrence; n is the total number of fittings having the same probability and m is number of fitting in use at any one time
- Probability factor of a particular no. of draw off's occurring at any one time is:
 - $P = (t - \text{time of appliance filling}) / (T - \text{time between successive usage of the appliance})$

* The "!" means "factorial" (n choose m), for example $4! = 1 \times 2 \times 3 \times 4 = 24$

Probability graph

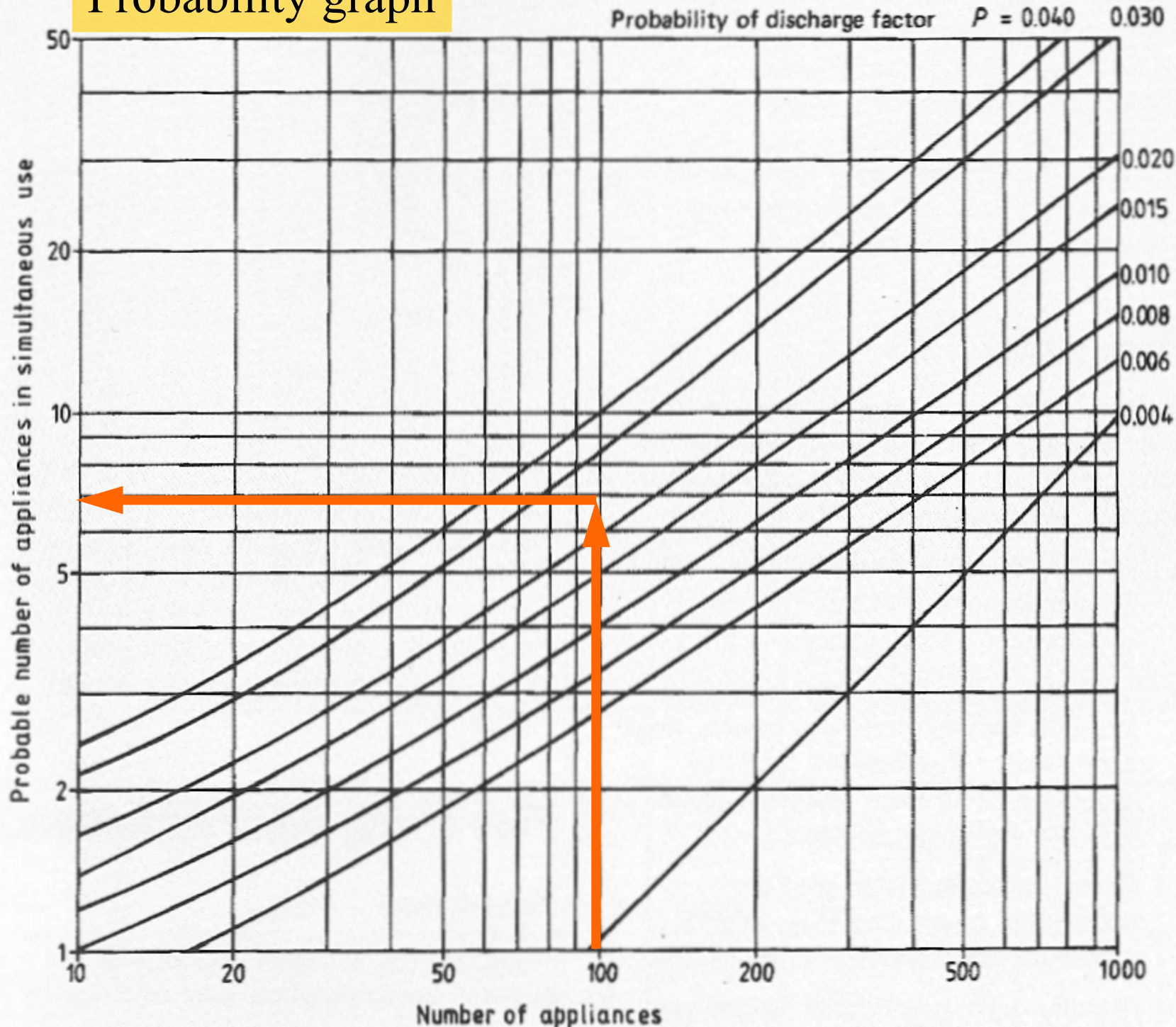

Example:
If 100 appliances each take 30 sec to be filled, and are used at 1200 sec (20 min) frequency interval, then:

$$P = t / T$$
$$= 30 / 1200$$
$$= 0.025$$

Using the graph, out of 100 appliances, only 7 would be in use at any one time.

Water demand & storage



- Simultaneous demand
 - Most fittings are used only at irregular intervals
 - It is unlikely that all the appliances will be used simultaneously
 - No need to size pipework on continuous max.
 - Key factors to consider:
 - Capacity of appliance (litres)
 - Draw-off flow rate (l/s)
 - Draw-off period, or time taken to fill appliance (sec)
 - Use frequency, time between each use (sec)

Water demand & storage



- Loading Unit (L.U.)

- A factor given to an appliance relating the flow rate at its terminal fitting to
 - Length of time in use
 - Frequency of use for a particular type
 - Use of building
- Evaluate the ‘probable maximum’
- Relates the flow rate to the probable usage
- Also, consider design & minimum flow rates

Design flow rates and loading units

Outlet fitting	Design flow rate (l/s)	Minimum flow rate (l/s)	Loading units
WC flushing cistern single or dual flush (to fill in 2 min.)	0.13	0.05	2
WC trough cistern	0.15 per WC	0.10	2
Wash basin tap size ½-DN 15	0.15 per tap	0.10	1.5-3.0
Spray tap or spray mixer	0.05 per tap	0.30	---
Bidet	0.2 per tap	0.10	1
Bath tap, ¾-DN 20	0.30	0.20	10
Bath tap, 1-DN 25	0.60	0.40	22
Shower head (will vary with type of head)	0.2 hot or cold	0.10	3
Sink tap, ½-DN 15	0.20	0.10	3
Sink tap, ¾-DN 20	0.30	0.20	5
Washing machine size – DN 15	0.2 hot or cold	0.15	---
Dishwasher size – DN 15	0.15	0.10	3
Urinal flushing cistern	0.004 per position	0.002	---

(Source: Garrett, R. H., 2008. *Hot and Cold Water Supply*)

Water demand & storage



- Apply probability theory, with caution
 - Assume random usage with fittings (is this true?)
 - Determine max. frequencies of use
 - Estimate average water usage rates & time
- The theory is valid with large nos. of fittings
 - Often expect to be exceeded at 1% time only
 - Reliability and risk management (what is the consequence)
- Need to understand the context/circumstance
 - Is it similar to average/typical? (* adjust data if needed)
 - Any foreseeable special requirements?

Water demand & storage



- Design flow considerations
 - A small increase in demand over design level will cause a slight reduction in pressure/flow (unlikely to be noticed by users)
- Exceptional cases, such as:
 - Cleaners' sinks (depends on one's behaviour)
 - Urinal flushing cisterns (constant small flow)
 - Team changing rooms at sport clubs (high demand)
 - Special events (ad hoc demand)

Water demand & storage



- Purposes of water storage
 - Provide for an interruption of supply
 - Accommodate peak demand
 - Provide a pressure (head) for gravity supplies
- Design factors
 - Type and number of fittings
 - Frequency and pattern of use
 - Likelihood and frequency of breakdown of supply (often design for 12- or 24-hour reserve capacity)

Recommended minimum storage of cold and hot water systems

Type of building	Minimum cold water storage (litres)	Minimum hot water storage (litres)
Hostel	90 per bed space	32 per bed space
Hotel	200 per bed space	45 per bed space
Office premises: - with canteen facilities - without canteen facilities	45 per employee 40 per employee	4.5 per employee 4.0 per employee
Restaurant	7 per meal	3.5 per meal
Day school: - nursery or primary - secondary or technical	15 per pupil 20 per pupil	4.5 per pupil 5.0 per pupil
Boarding school	90 per pupil	23 per pupil
Children's home or residential nursery	135 per bed space	25 per bed space
Nurses' home	120 per bed space	45 per bed space
Nursing or convalescent home	135 per bed space	45 per bed space

Note: Minimum cold water storage shown includes that used to supply hot water outlets.

Estimation of cold water storage per occupant

Type of building	Storage per occupant (litres)
Factories (no process)	10
Hospitals, per bed	135
Hospitals, per staff on duty	45
Hostels	90
Hotels	135
Houses and flats	135
Offices with canteens	45
Offices without canteens	35
Restaurant (* per meal)	7
Schools, boarding	90
Schools, day	30

Estimation of hot water consumption

Type of building	Consumption per occupant (litres/day)	Peak demand per occupant (litres/hr)	Storage per occupant (litres)
Factories (no process)	22 – 45	9	5
Hospitals, general	160	30	27
Hospitals, mental	110	22	27
Hostels	90	45	30
Hotels	90 – 160	45	30
Houses and flats	90 – 160	45	30
Offices	22	9	5
Schools, boarding	115	20	25
Schools, day	15	9	5

Fixtures water requirements (demand at individual water outlets)

Type of fixture	Flow rate (litres/min)	Minimum supply pressure (kPa)
Bathtub faucet	19	55
Bidet	7.5	28
Laundry machine	15	55
Lavatory faucet, ordinary	7.5	55
Lavatory faucet, self closing	10	55
Shower head	19	55
Shower, temperature controlled	10	138
Sink 3/8", 1/2"	17	55
Sink 3/4"	23	55
Urinal flush valve	56	110
Water closet with flush valve	132	170
Water closet with gravity tank	10	55

Fixtures, cold water storage, hot water consumption & flow rate

Type of fixture	Cold water storage capacity (litres)	Hot water consumption (litre/hr)	Hot water flow rate (litre/s)
Basin (private)	90	14	0.08
Basin (public)	90	45	0.08
Bath	900	90 – 180	0.15
Garden water tap	180	---	---
Shower	450 – 900	180	0.5 – 0.6
Sink	90	45 – 90	0.15
Urinal	180	---	---
WC	180	---	---

Quantity of flushing water required

User	Average demand
Domestic buildings	450 litres per number of required soil fitment per day
Offices, factories, department stores, shops, public buildings and other nondomestic buildings of a like nature	450 litres per number of required soil fitment per day
Restaurants	13.5 litres per seat per day
Cinemas	4.5 litres per seat per day
Schools	18 litres per head per day
Hotels and boarding houses	90 litres per room per day

Water demand & storage



- Minimum hot water storage capacities for dwelling (from BS6700)
 - 35-45 litre per occupant (unless the heat source provides a quick recovery rate)
 - 100 litres for systems heated by solid fuel boilers
 - 100 litres for systems heated by off-peak electricity

Water demand & storage



- Recovery rate and hot water storage
 - Recovery period = time to heat up the stored water
 - Too high a storage volume: unnecessary costs
 - Inadequate storage: loads not met
 - Need to consider the following factors:
 - Pattern of use
 - Rate of heat input to the stored water
 - Recovery period for the hot water storage vessel
 - Any stratification of the stored water

Typical heat input values

Appliance	Heat input (kW)
Electric immersion heater	3
Gas-fired circulator	3
Small boiler and direct cylinder	6
Medium boiler and indirect cylinder	10
Directly gas-fired storage hot water heater (domestic type)	10
Large domestic boiler and indirect cylinder	15

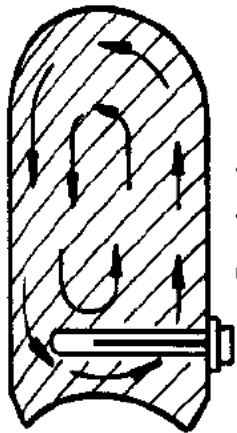

(a) Bottom entry heater

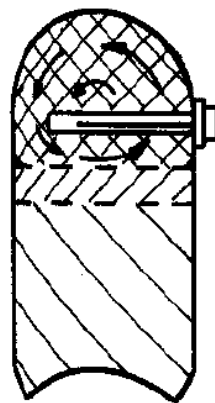

(b) Top entry heater

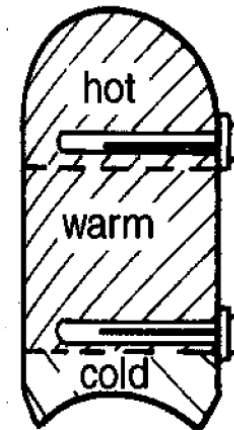

(c) Twin entry heater

Effects of stratification

Water demand & storage



- Formula to calculate recovery period
 - $M = V T / (14.3 P)$
 - M = time to heat the water (min.)
 - V = volume of water heated (litres)
 - T = temperature rise (°C)
 - P = rate of heat input to the water (kW)
 - It can be applied to any pattern of use
 - It ignores heat losses from storage vessel

Example: A small dwelling with one bath. Maximum requirement: 1 bath (60 litre at 60°C + 40 litre cold water) plus 10 litre hot water at 60°C for kitchen use, followed by a second bath fill after 25 min. Thus, a draw-off of 70 litre at 60°C is required, followed after 25 min by 100 litre at 40°C, which may be achieved by mixing hot at 60°C with cold at 10°C.

Answer:

1) Assume good stratification (by heating w/ a top entry heater)

With 3kW heat input, the time to heat the 60 litre for the second bath from 10°C to 60°C:

$$M = V T / (14.3 P) = (60 \times 50) / (14.3 \times 3) = 70 \text{ min.}$$

The second bath is required after 25 min., thus it has to be from storage. But in the 25 min. the volume of water heated to 60°C is:

$$V = M (14.3) / T = (25 \times 14.3 \times 3) / 50 = 21 \text{ litre}$$

Therefore, the minimum required storage capacity is:

$$70 + 60 - 21 = \underline{\mathbf{109 \text{ litre}}}$$

Example: (Cont'd)

2) Assume good mixing of the stored water (by a primary coil in an indirect cylinder)

After the first bath & kitchen use, the heat energy in the 70 litre replacement at 10°C equals the heat energy of the water in the full cylinder. If V is the min. size of the storage and T is the water temperature in the cylinder after refilling:

$$(V - 70) \times 60 + (70 \times 10) = V T$$

$$T = (60 V - 4200 + 700)/V \quad \text{or} \quad T = 60 - 3500/V$$

The second bath is required after 25 min. With 3 kW heat input:

$$25 = V T / (14.3 \times 3)$$

$$\text{and temperature rise } T = (25 \times 14.3 \times 3) / V = 1072.5/V$$

A temperature of at least 40°C is required to run the second bath.

Therefore the water temperature of the refilled cylinder after the first draw-off, plus the temperature rise after 25 min., must be at 40°C, or:

$$(60 - 3500/V) + (1072.5/V) = 40 \text{ (or more)}$$

$$60 - 2427.5/V = 40$$

$$V = \underline{\underline{122 \text{ litre}}}$$

Hot water storage vessel – minimum capacities

Heat input for water (kW)	Dwelling with 1 bath		Dwelling with 2 baths*	
	With stratification litres	With mixing litres	With stratification litres	With mixing litres
3	109	122	165	260
6	88	88	140	200
10	70	70	130	130
15	70	70	120	130

Note: * Maximum requirement of 150 litre drawn off at 60°C (2 baths plus 10 litre for kitchen use) followed by a further bath (100 litre at 40°C) after 30 min.

Pipe sizing

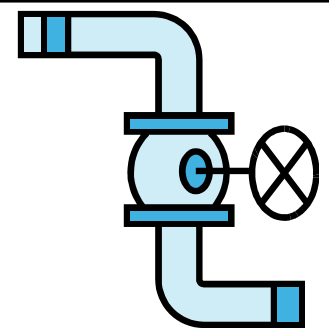

- Correct pipe sizes will ensure adequate flow rates at appliances and avoid problems, e.g.
 - Oversizing
 - Additional & unnecessary installation costs
 - Delays in obtaining hot water at outlets
 - Increased heat losses from hot water pipes
 - Undersizing
 - Inadequate delivery from outlets
 - Some variation in temperature & pressure at outlets (e.g. showers and other mixers)
 - Some increase in noise levels
- For small, simple installations, pipes are often sized based on experience & convention

1 m head = 9.81 kPa
= 98.1 mbar

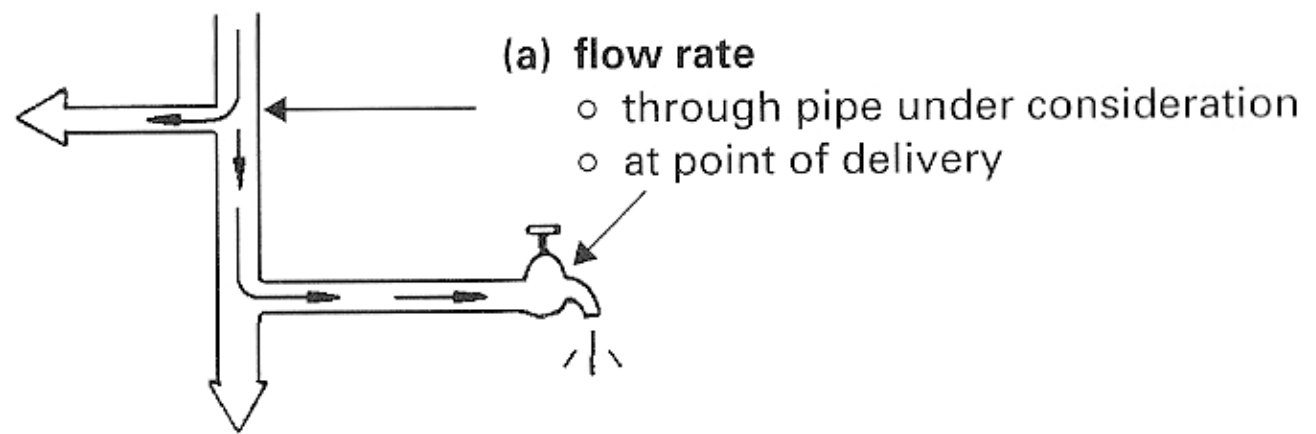

Available head (from cistern)
= vertical distance in metres
from water line in cistern to
point under consideration

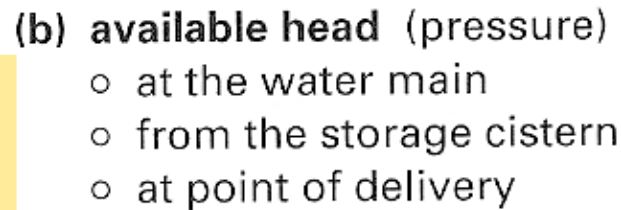

Available head (mains supply)
= head at main minus height
above main
= 20 m – 4 m
= 16 m head

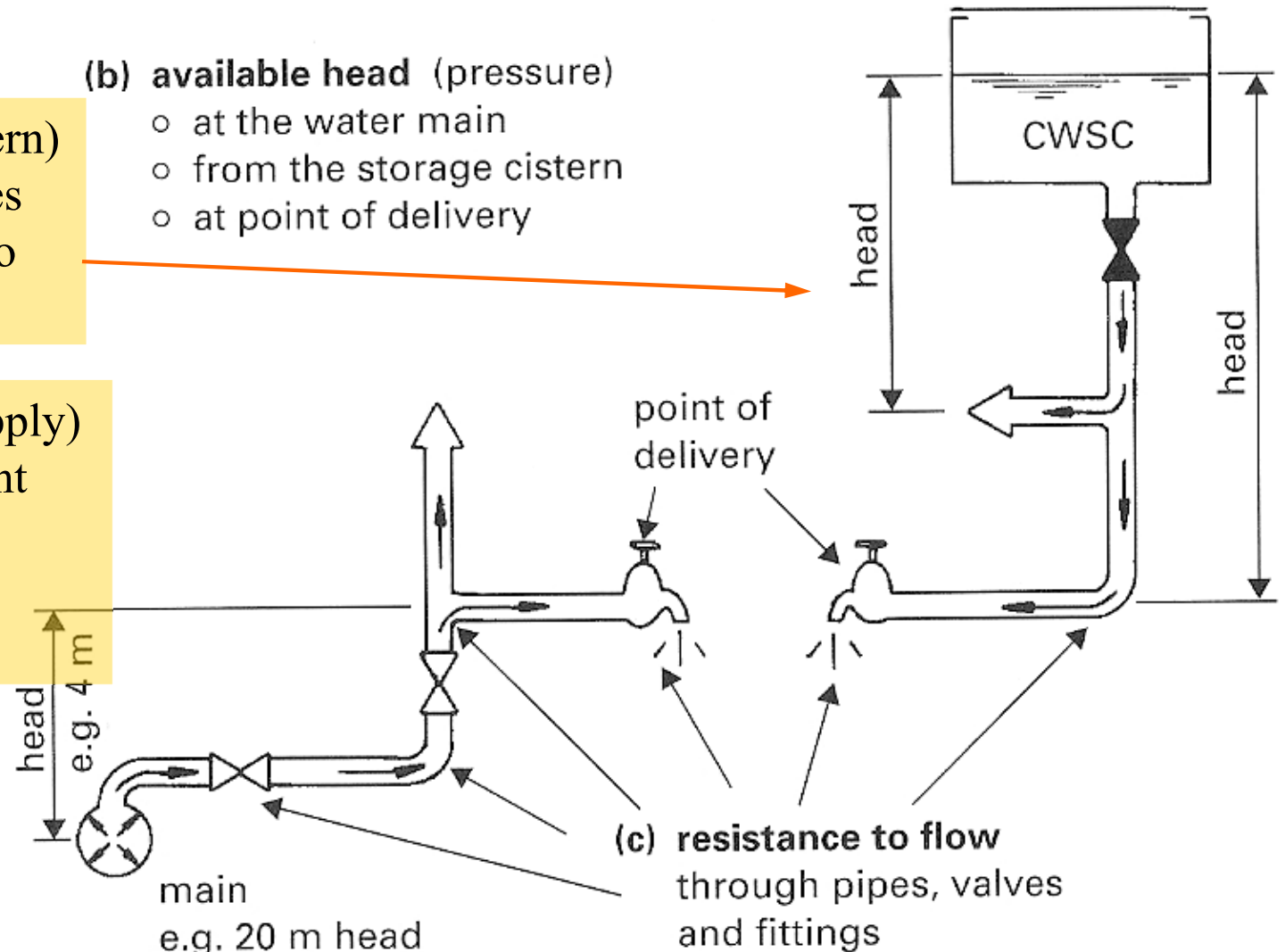

Pipe sizing

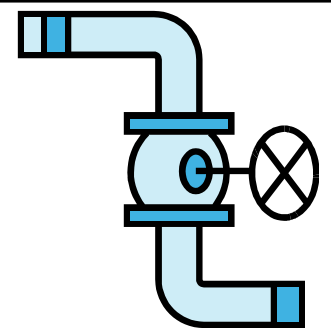

- Pipe sizing procedure
 - (a) Assume a pipe diameter
 - (b) Determine the flow rate:
 - 1) by using loading units
 - 2) for continuous flow
 - 3) obtain the design flow rate by adding 1) and 2)
 - (c) Determine the effective pipe length:
 - 4) work out the measured pipe length
 - 5) work out the equivalent pipe length for fittings
 - 6) work out the equivalent pipe length for draw-offs
 - 7) obtain the effective pipe length by adding 4), 5) & 6)

Pipe sizing

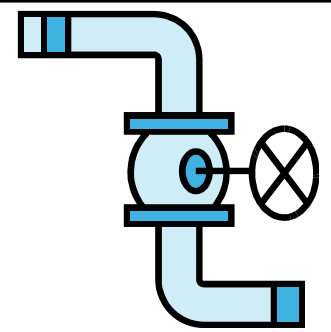

- Pipe sizing procedure (cont'd)
 - (d) Calculate the permissible loss of head:
 - 8) determine the available head
 - 9) determine the head loss per metre run through pipes
 - 10) determine the head loss through fittings
 - 11) calculate the permissible head loss
 - (e) Determine the pipe diameter:
 - 12) decide whether the assumed pipe size will give the design flow rate in 3) without exceeding the permissible head loss in 11)
 - Usually, flow velocities shall be < 3 m/s

Example of use of loading units

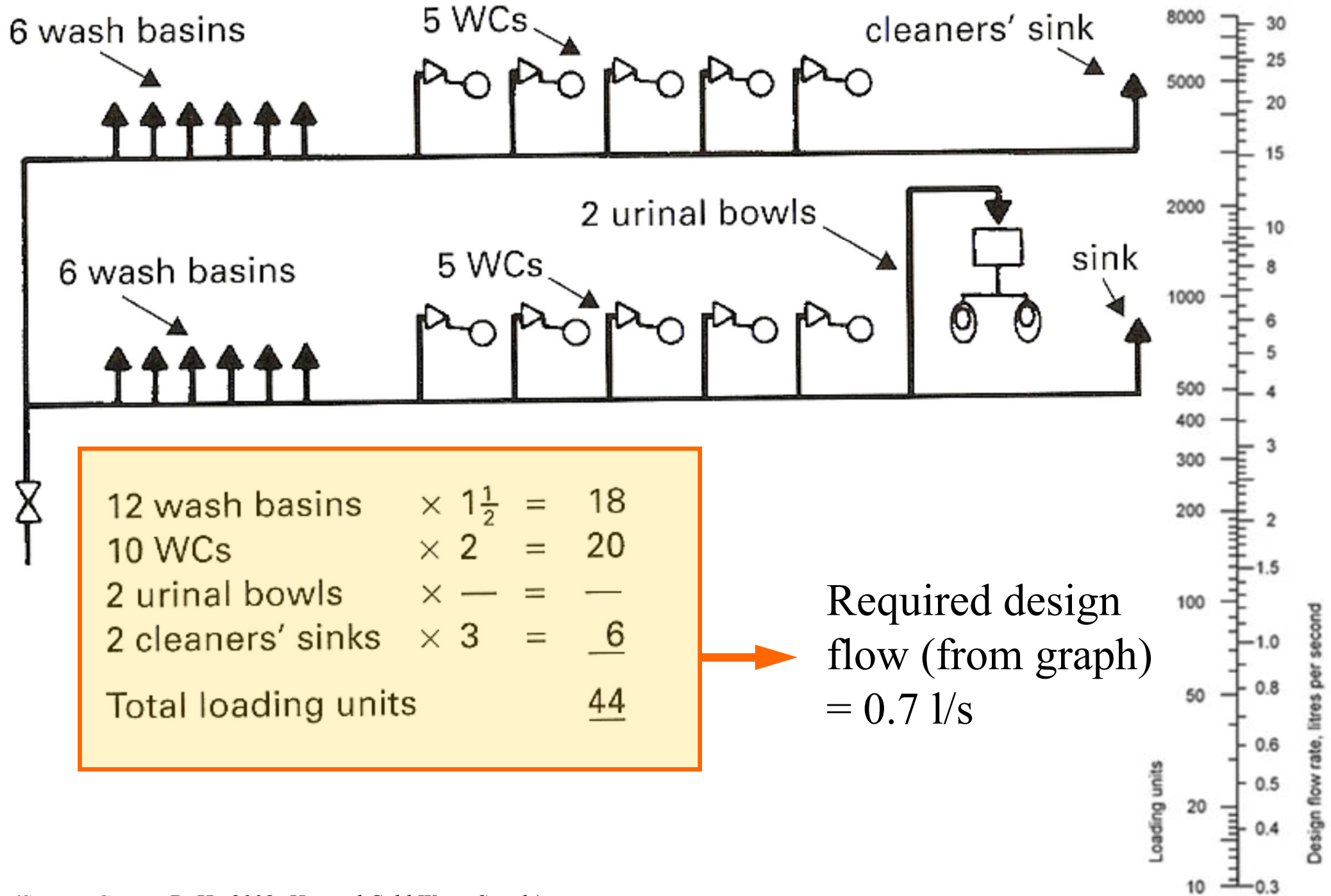

Example of measured & effective pipe lengths

Assumed pipe diameter 20 mm.

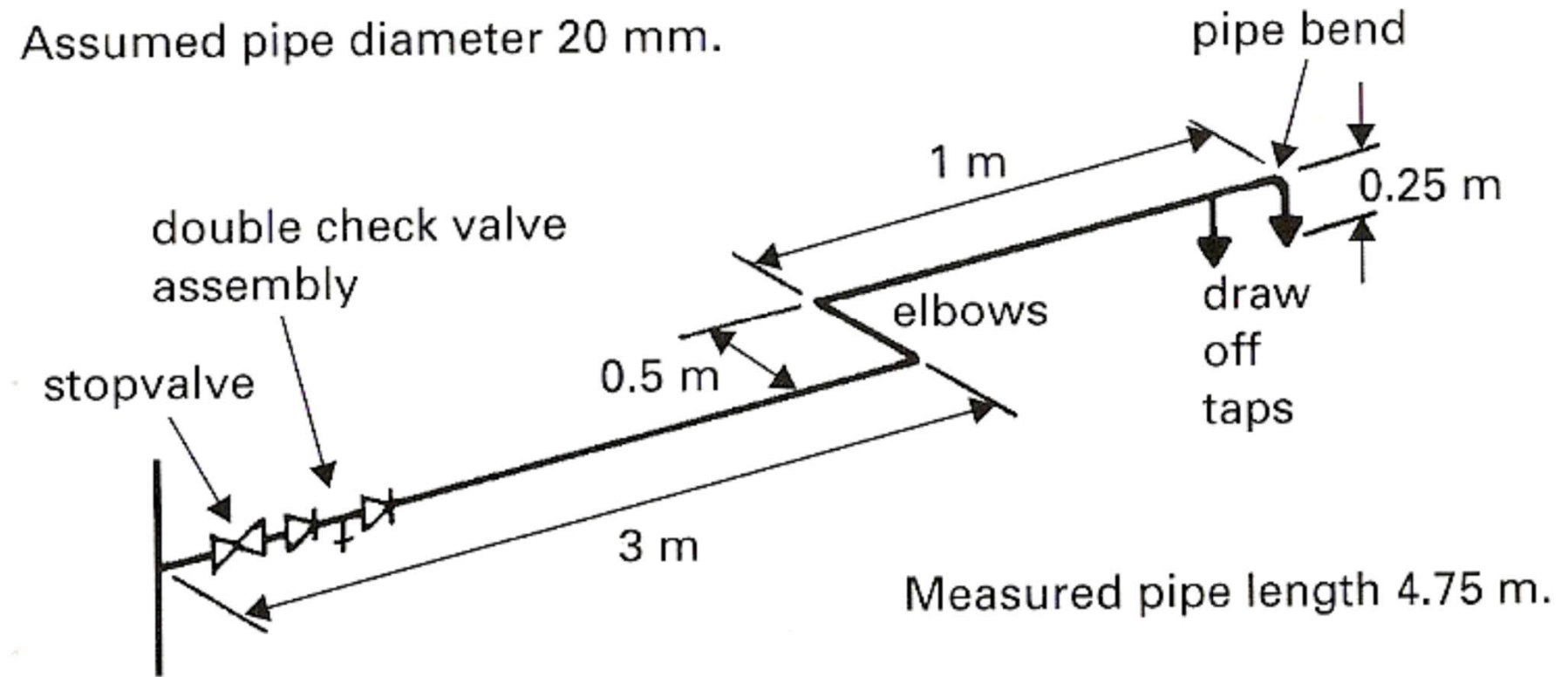

Measured pipe length 4.75 m.

Note There is no need to consider both branch pipes to taps.

Measured pipe length = 4.75 m

Equivalent pipe lengths:

elbows $2 \times 0.8 = 1.6$ m

tee $1 \times 1.0 = 1.0$ m

stopvalve $1 \times 7.0 = 7.0$ m

taps $2 \times 3.7 = 7.4$ m

check valves $2 \times 4.3 = 8.6$ m

Effective pipe length = **30.35 m**

Equivalent pipe lengths (copper, stainless steel and plastics)

Bore of pipe (mm)	Equivalent pipe length (m)			
	Elbow	Tee	Stopvalve	Check valve
12	0.5	0.6	4.0	2.5
20	0.8	1.0	7.0	4.3
25	1.0	1.5	10.0	5.6
32	1.4	2.0	13.0	6.0
40	1.7	2.5	16.0	7.9
50	2.3	3.5	22.0	11.5
65	3.0	4.5	---	---
73	3.4	5.8	34.0	---

Nominal size of tap	Flow rate (l/s)	Head loss (m)	Equiv. pipe length (m)
G1/2- DN 15	0.15	0.5	3.7
G1/2- DN 15	0.20	0.8	3.7
G3/4- DN 20	0.30	0.8	11.8
G1- DN 25	0.60	1.5	22.0

(Source: Garrett, R. H., 2008. *Hot and Cold Water Supply*)

Example of permissible head loss

Pressure at taps 45 m head

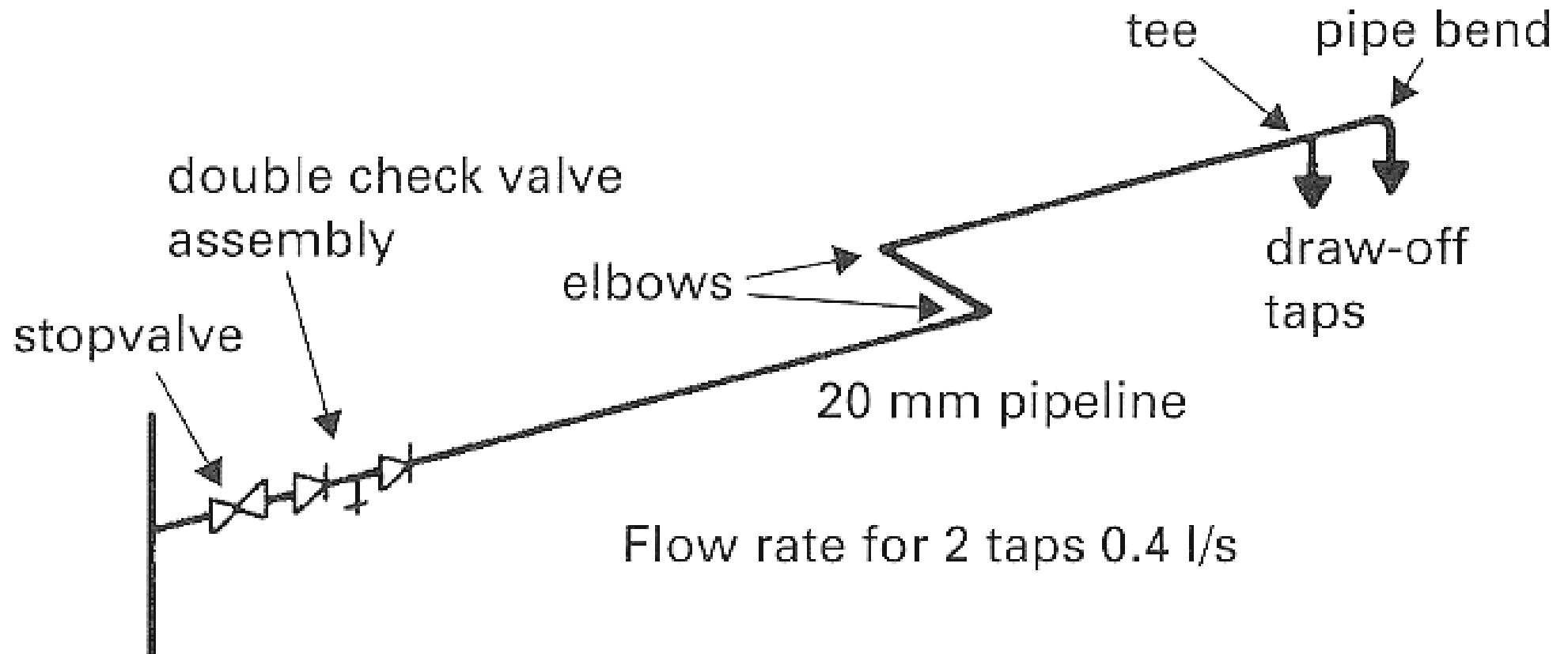

Flow rate for 2 taps 0.4 l/s

$$\text{Permissible head loss} = \frac{\text{available head (45 m)}}{\text{effective pipe length (30.55 m)}} \\ = 1.48 \text{ m/m run}$$

Loss of head: 0.12 m/m run

Determination of pipe diameter

Pipe size 20 mm

Design flow rate 0.4 l/s

Flow velocity 1.4 m/s

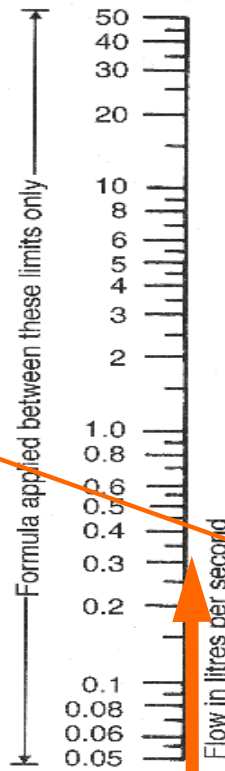
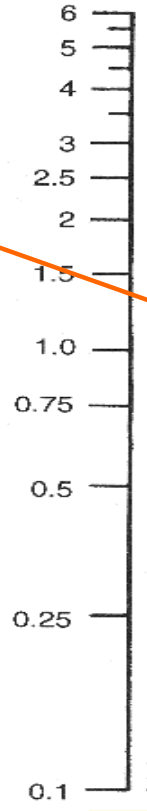
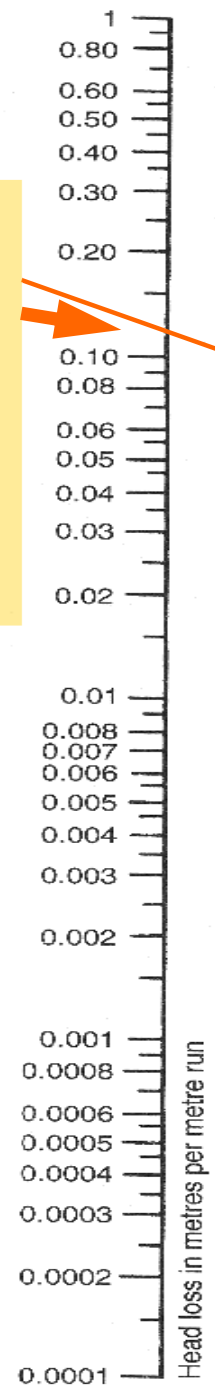

Formula applied between these limits only

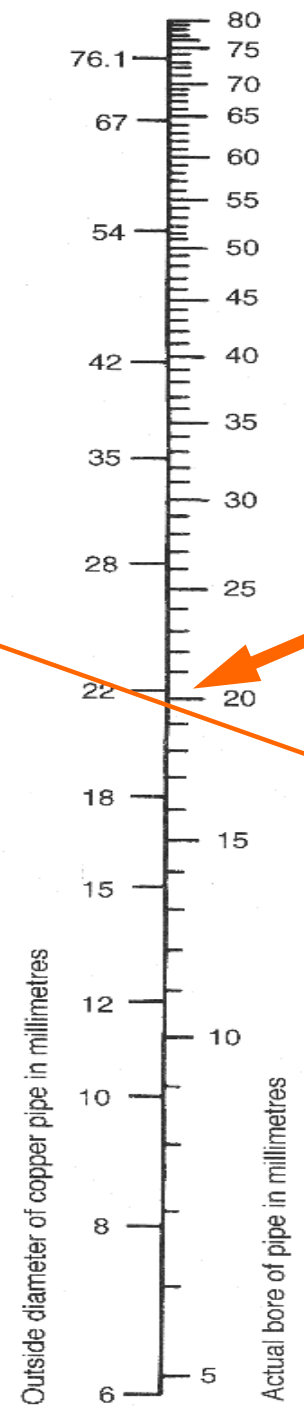

Lamont's smooth pipe formula S3:

$$V = 0.552 d^{0.6935} i^{0.5645}$$

Where V is velocity (m/s)
 d is diameter (mm)
 i is hydraulic gradient

Note Figures shown are for cold water at 12°C. Hot water will show slightly more favourable head loss results.

(Source: Garrett, R. H., 2008. *Hot and Cold Water Supply*)

Maximum recommended flow velocities

Water temperature (°C)	Flow velocity (m/s)	
	Pipes readily accessible	Pipes not readily accessible
10	3.0	2.0
50	3.0	1.5
70	2.5	1.3
90	2.0	1.0

Note: Flow velocities should be limited to reduce system noise.

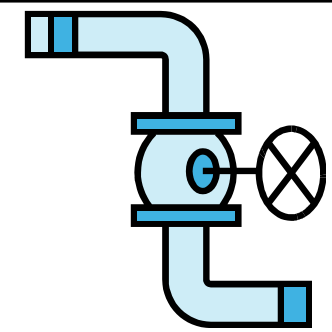

Pipe sizing

- Pipe sizing & design using tabular methods
 - Systematic way to design
 - Can also be done using spreadsheet or computer

Table D.4 Example of pipe sizing calculations for cold water services

Pipe reference	Flow rate		Pipe size	Velocity v	Head loss R	Drop + Rise -	Available head (7 + 14)	Pipe length		Head loss			Residual			
	Total	Design						Actual	Effective	Pipe (10 × 6)	Valves ^{A)}	Total (11 + 12)	Available (8 - 13)	Fitting type	Required	Surplus
m	LU	l/s	DN	m/s	kPa/m	kPa	kPa	m	m	kPa	kPa	kPa	kPa		kPa	kPa
1	2	3	4	5	6	7	8	9	10	11	12	13	14	15	16	17
Main service pipe - for this example the minimum head in main = 300 kPa (3 bar)																
1 to 2	9 + list	0.6 + 0.3 0.9	28	1.7	1.4	-50	250	25	35	49	2 SV = 21	70	180			
2 to 3	6 + list	0.4 + 0.2 0.6	22	2.0	2.5	-30	150	3	4.2	11		11	139			
3 to 4	3 + list	0.2 + 0.1 0.3	15	2.2	5	-30	109	3	4.2	21		21	88			
4 to 5	3 + list	0.3	15	2.2	5	+10	98	1	1.4	7	SV = 18	25	73			
5 to 6		0.2	15	1.5	2.3	+10	83	6	8.4	20		20	63	sink float valve (5 mm ϕ)	5	58
5 to 7		0.1	15	0.75	0.6	-5	68	1	1.4	1		1	67		30	37

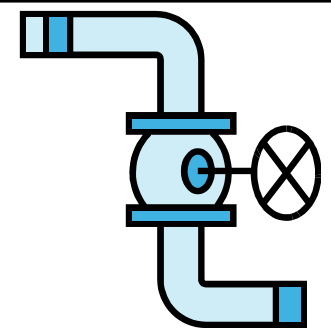

Pipe sizing

- Pipe sizing for hot water systems
 - The same as cold water, except cold feed pipe must also be considered

- Useful formulae for pipes:

- Thomas Box formula

- See example

$$q = \sqrt{\frac{d^5 \times H}{25 \times L \times 10^5}}$$

- Relative discharging power

- See example

$$N = \sqrt{\left(\frac{D}{d}\right)^5}$$

Example: Determine the pipe size using Thomas Box formula.

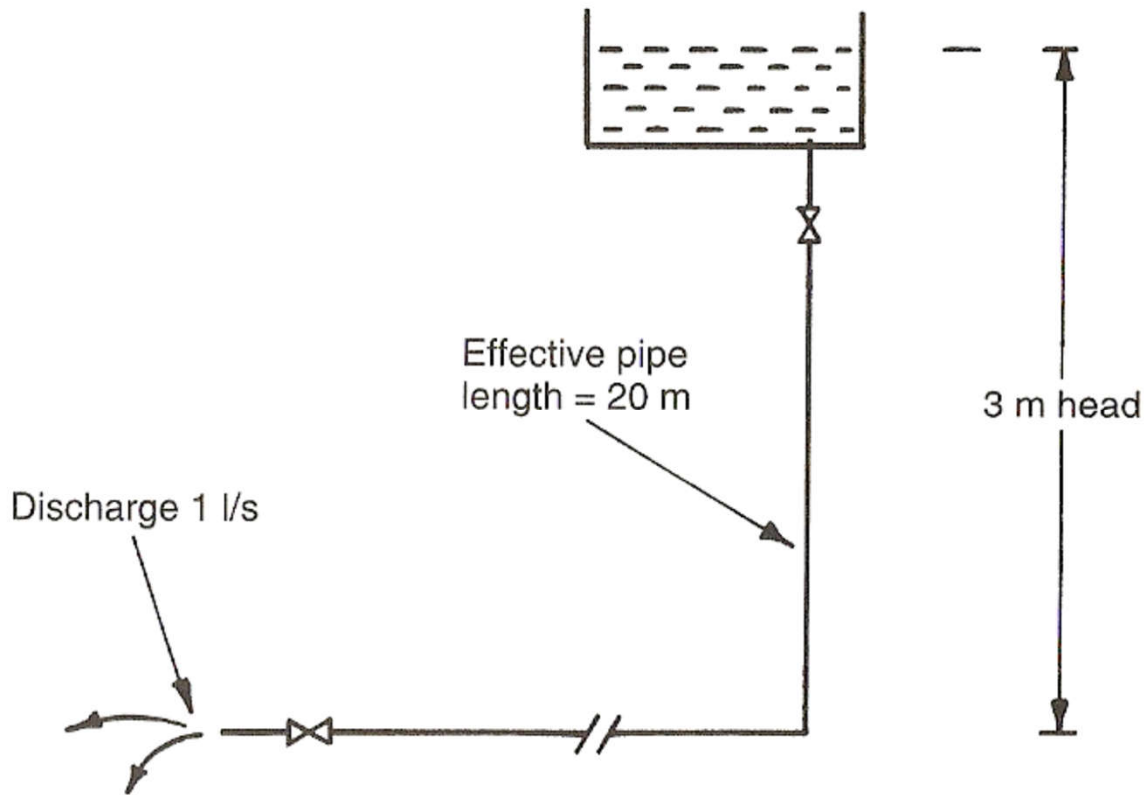

$$q = \sqrt{\frac{d^5 \times H}{25 \times L \times 10^5}}$$

where d = pipe diameter (mm)
 q = flow rate (l/s)
 H = head or pressure (m)
 L = effective length of pipe (actual length + allowance for bends, tees, etc.)

Answer: Using Thomas Box formula,

$$d = \sqrt[5]{\frac{(1)^2 \times 25 \times 20 \times 10^5}{3}} = \underline{\underline{27.83 \text{ mm}}}$$

Hence, the nearest commercial size is 32 mm bore steel or 35 mm outside diameter copper.

Example: Relative discharge of pipes

$$N = \sqrt{\left(\frac{D}{d}\right)^5}$$

where N = number of short branch pipes
 D = diameter of main pipe (mm)
 d = diameter of short branch pipes (mm)

(a) The number of 32 mm short branch that can be served from 150 mm main.

Answer: $N = \sqrt{\left(\frac{150}{32}\right)^5} = 47$

(b) The size of water main required to supply 15 nos. 20 mm short branch pipes.

Answer: $D = d \times \sqrt[5]{N^2} = 20 \times \sqrt[5]{15^2} = 59$

Hence, the nearest commercial size is 65 mm.

Pipe materials

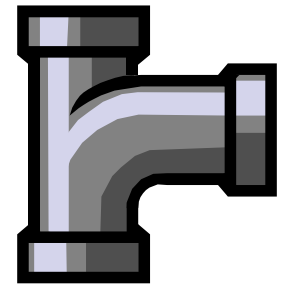

- Design & selection factors:
 - Effect on water quality
 - Cost, service life and maintenance needs
 - For metallic pipes, internal and external corrosion
 - Compatibility of materials
 - Ageing, fatigue and temperature effects, especially in plastics
 - Mechanical properties and durability
 - Vibration, stress or settlement
 - Internal water pressure

Pipe materials

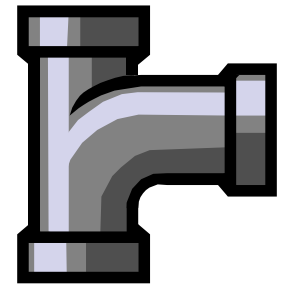

- Commonly used pipe materials, such as:
 - Copper (BS EN 1057)
 - Galvanised iron (GI) w/ PVC-C lining (BS 1387)
 - PVC, unplasticized PVC, PB, PE, PE-X
 - Stainless steel (BS 4127)
 - Ductile iron (BS EN 545) (for pipe dia. > 80 mm)
 - Mild steel (for pipe dia. > 600 mm)
- * Plastic material generally will degrade on prolonged exposure to ultra-violet light



Copper pipe

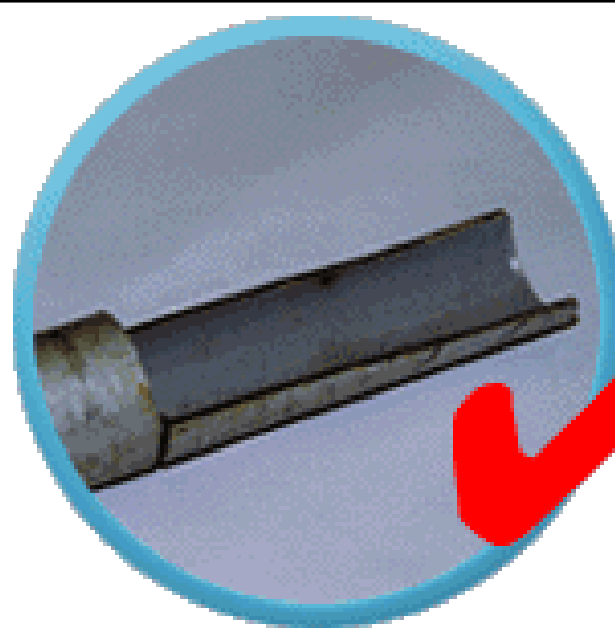

Lined galvanized steel pipe

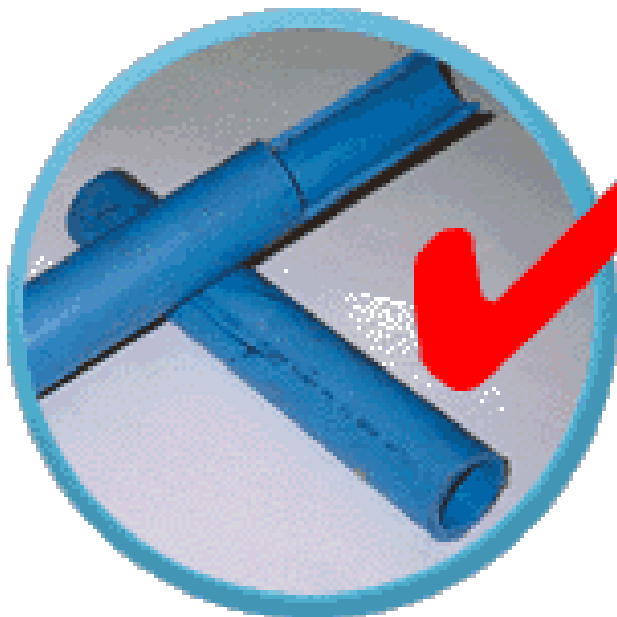

Polyethylene pipe

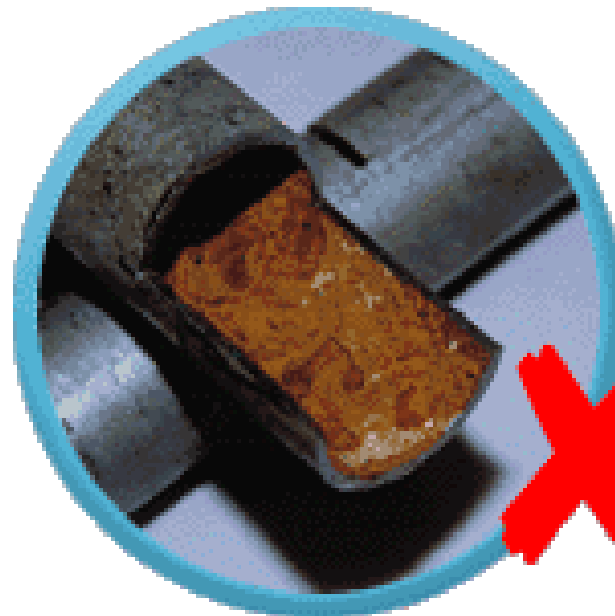

Rusty unlined galvanized steel pipe

Applicable materials for fresh water and salt water inside service

Pipe/ Pipe fitting material	Fresh Water Inside Service		Salt Water Inside Service ⁽¹⁾
	Cold Water	Hot Water	
Copper	✓	✓	✗
Ductile iron (with internal coating)	✓	✓	✓
Polyethylene (PE)	✓		✓ ⁽²⁾
Polyethylene-cross-linked (PE-X)	✓	✓	✗
Plastic lined steel (PVC-C lining)	✓	✗	✗
Plastic lined steel (PVC-U/ PE lining)	✓	✗	✗
Polyvinyl chloride - chlorinated (PVC-C)	✓	✓	✗
Polyvinyl chloride - unplasticized (PVC-U)	✓		✓
Stainless steel	✓	✓	✗

✓ : Suitable for use when the relevant standards are complied with in general

✗ : Not suitable for use in general

(1) : Suitable location(s) for installation may refer to fresh water inside service

(2) : When installed in exposed condition, black pipe and pipe fittings shall be used.

Pipe materials

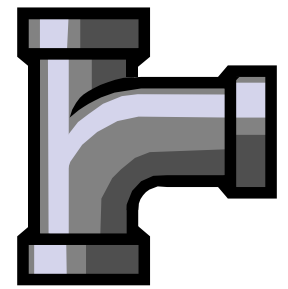

- Classification of pipe materials

- Metallic

- Copper
- Stainless steel

- Thermoplastics

- PVC-U, PVC-C
- Polyethylene (PE)
- Medium Density Polyethylene (MDPE)
- High Density Polyethylene (HDPE)
- Crosslinked Polyethylene (PEX)



Pipe materials

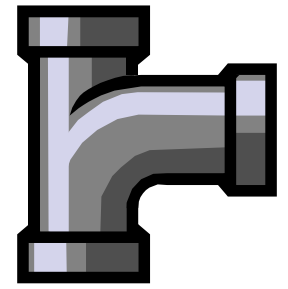

- Classification of pipe materials (cont'd)
 - Thermoplastics (cont'd)
 - Polybutylene (PB)
 - Acrylonitrile Butadiene Styrene (ABS)
 - Composite
 - Lined galvanised steel
 - Crosslinked Polyethylene/Aluminium/Crosslinked Polyethylene Composite Pressure Pipe (PEX-AL-PEX)
 - High Density Polyethylene/Aluminium/ High Density Polyethylene (HDPE-AL-HDPE)

Pipe materials

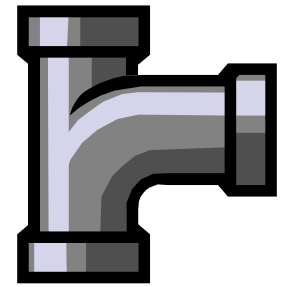

- Copper pipes (BS EN 1057)

- Advantages:

- High pressure capability
- Good formability
- Good corrosion resistance
- High strength & durability to withstand external loading
- Ease of jointing (compression & capillary joints)
- Smooth surface: low resistance to water flow
- Suitable for conveying hot water

- Disadvantages:

- Soft water can cause internal corrosion attack (give rise to 'blue' water)

Pipe materials

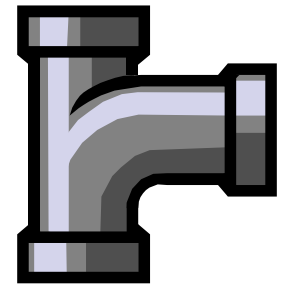

- Stainless steel (BS 4127)
 - Advantages:
 - High pressure capability
 - Good corrosion resistance
 - High strength & durability
 - Ease of jointing
 - Good resistance to accidental damage
 - Suitable for conveying hot water
 - Disadvantage:
 - More expensive than copper

Pipe materials

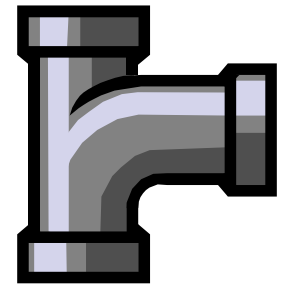

- Lined galvanised steel
 - PVC-U/PVC-C/Polyethylene or epoxy resin lined
 - Advantages:
 - Good resistance to internal corrosion & encrustation
 - Smooth surface: lower resistance to water flow
 - Can be used in vulnerable conditions e.g. exposure to direct sunlight & traffic loads
 - Readily compatible with existing commonly used unlined steel pipe
 - Disadvantages:
 - Heavy weight
 - Susceptible to impact damage (great care in handling)
 - Higher skills required for cutting, threading, jointing

Pipe materials

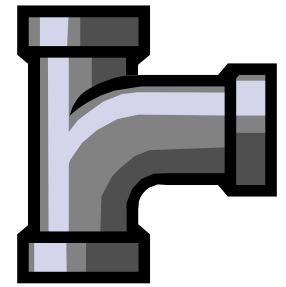

- PVC-U (BS 3505 Class D)
 - Advantages:
 - Good corrosion resistance
 - Light weight, low cost
 - Ease of jointing
 - Smooth surface: low resistance to water flow
 - Not a conductor of electricity (no galvanic/oxidative corrosion)
 - Disadvantages:
 - Brittle, susceptible to impact damage
 - Long drying time of solvent cement in jointing
 - Low abrasion resistance
 - Permeation/degradation by certain organic contaminants
 - UV degradation on prolonged exposure to sunlight
 - Not suitable for hot water supply

Pipe materials

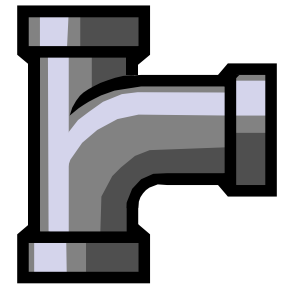

- PVC-C (BS 7291)

- Advantages:

- Suitable for conveying hot water
 - Good corrosion resistance & chemical resistance
 - Light weight
 - Smooth surface: low resistance to water flow
 - Not a conductor of electricity (no galvanic/oxidative corrosion)
 - Can be connected to other materials easily

- Disadvantages:

- Brittle, susceptible to impact damage
 - Long drying time of solvent cement in jointing
 - Can be flammable
 - Reduction in strength & rigidity with increase of temperature
 - Permeation/degradation by certain organic contaminants
 - Can be attacked by detergents & oxidizing agents
 - UV degradation on prolonged exposure to sunlight

Pipe materials

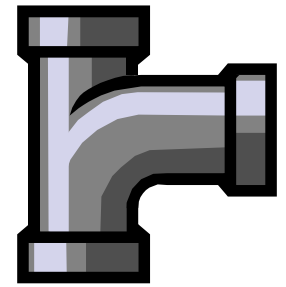

- MDPE (BS 7291)

- Advantages:

- Good corrosion resistance
- Good formability
- Light weight
- Fusion & mechanical joint available
- Smooth surface: low resistance to water flow
- Strong & tough
- Flexible & durable, light & easy to handle
- Good resistance to impact

- Disadvantages:

- Fusion jointing requires skilled installers & special equipment
- Subject to creep
- Strength decrease with time (at a very slow rate)
- UV degradation on prolonged exposure to sunlight
- Permeation/degradation by certain inorganic & organic contaminants

Pipe materials

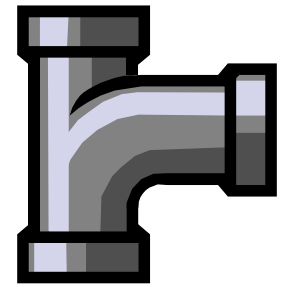

- Jointing of pipes

- Copper pipes

- Capillary solder or brazed joints
 - Autogenous welding
 - Compression, push, press/crimp fittings

- Steel pipes

- Screwed joints, with pipe threads
 - Flange joints (screwed or welded flanges)

- Stainless steel pipes

- Compression, capillary, push, press/crimp fittings (but not joined by soft soldering)

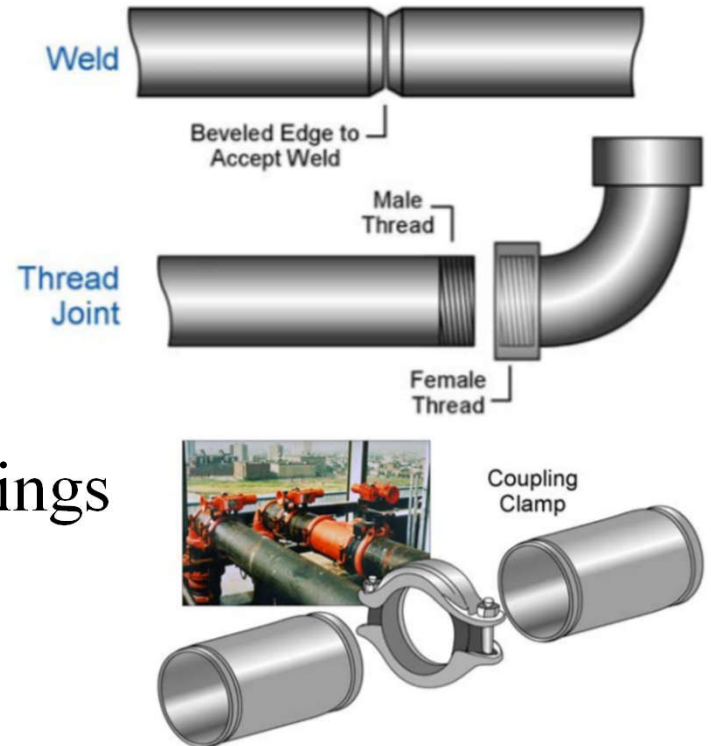

Pipe materials

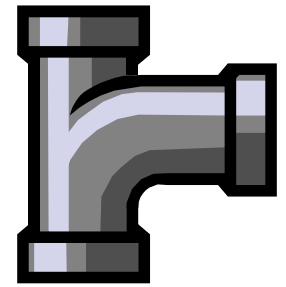

• Jointing of pipes (cont'd)

- Unplasticized PVC pipes
 - Mechanical joints
 - Compression joints
 - Solvent cement welded joints
 - Flange joints

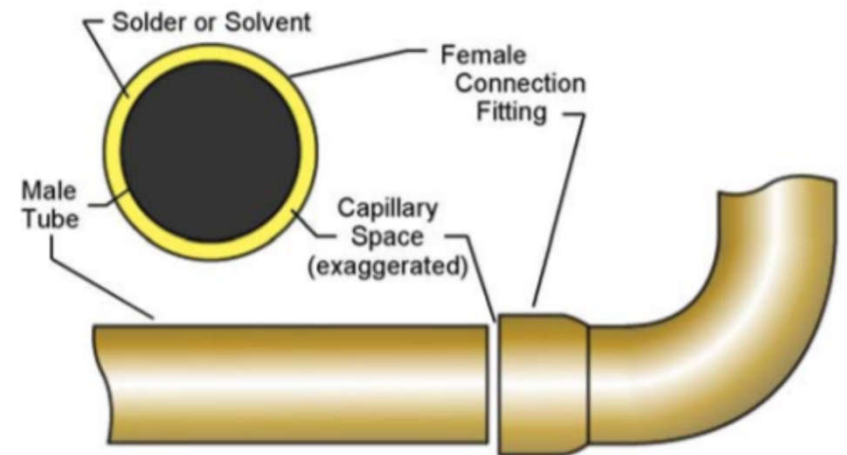

- Polyethylene (PE) & polybutylene (PB) pipes
 - Mechanical joints (e.g. push-fit), thermal fusion
- Acrylonitrile Butadiene Styrene (ABS) pipes
 - Similar to PVC-U pipes

Pipe materials

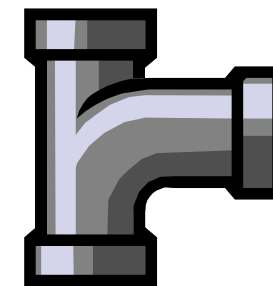

- Pipes & fittings for plumbing systems in HK
 - Water supply pipes & fittings with valid General Acceptance (GA)
 - Applicable standards
 - Voluntary GA labelling scheme for plumbing products
 - Voluntary quality assurance information scheme (GA+)
 - Voluntary low metal leaching rate pipes and fittings scheme (GA*)



水務署

Water Supplies Department

Voluntary GA (General Acceptance) Labelling Scheme for plumbing products

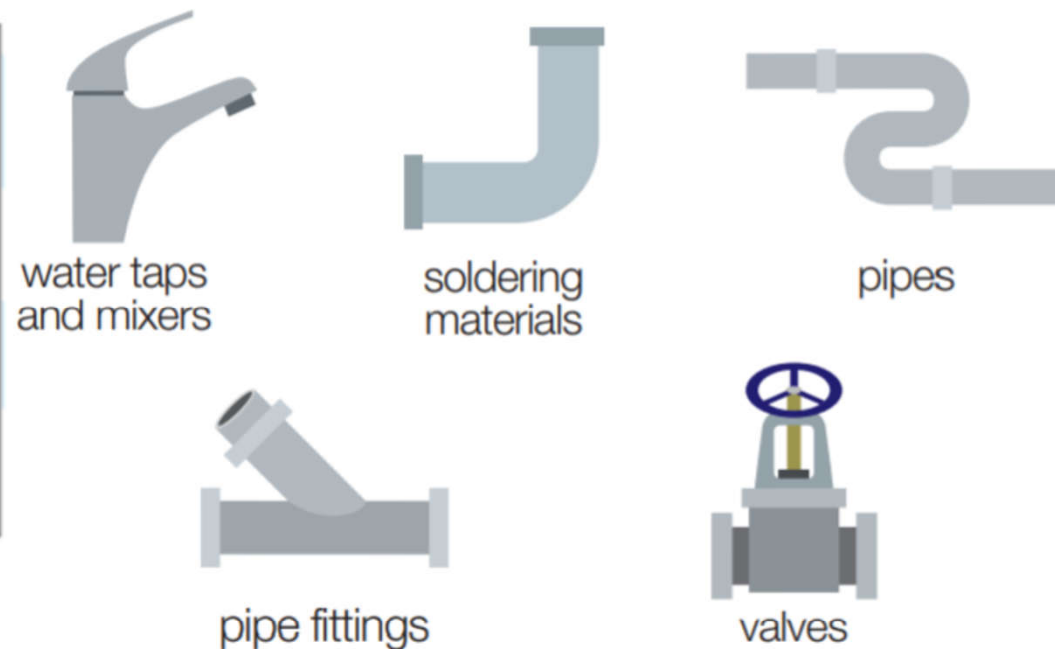

Pump systems



- Centrifugal pumps are commonly used
 - Vertical and horizontal
 - Single & multiple stages
- Two types of systems:
 - Closed systems
 - Recirculation
 - Open systems
 - Open to atmosphere



Main characteristics of centrifugal & positive displacement pumps

Centrifugal pumps	Positive displacement pumps
<ul style="list-style-type: none">- Capacity varies with head- Capacity proportional to pump speed- Head proportional to the square of pump speed- Non self-priming- Suitable for low-viscosity liquid	<ul style="list-style-type: none">- Capacity substantially independent of head- Capacity proportional to speed- Self-priming- Suitable for various liquids (reduced speeds usually necessary for high viscosity)

Pump pressure effects in an open system

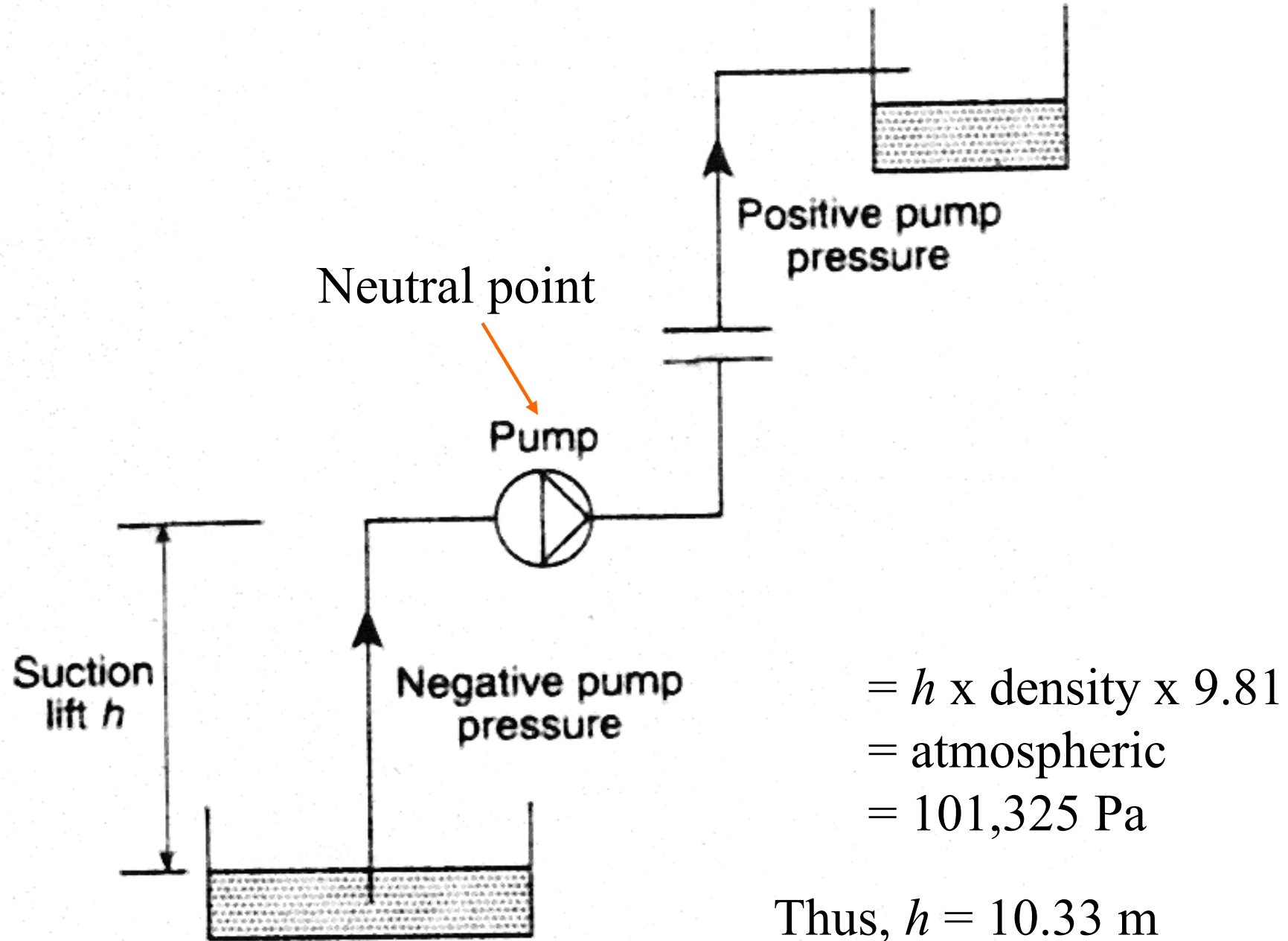

Pump systems



- Pump considerations
 - Practical suction lift is 5 m maximum
 - Also known as net positive suction head (NPSH)
- Pump location is important for both closed and open systems
 - Open system: not excessive to avoid cavitation
 - Close system: Influence water level of open vent pipe & the magnitude of antiflash margin (temp. difference between water & its saturation temp.)
 - 'Self-priming' to evacuate air from suction line

Pump systems



- Pump characteristics
 - Characteristics curves (e.g. from catalogue):
 - Total head
 - Power
 - efficiency
 - No-flow conditions (flow = zero)
 - Close valve pressure
 - Need to prevent over-heat
 - Pump power (W) = flow (L/s) x pressure (kPa)

Pump characteristics curves (centrifugal)

Maximum generated head, closed valve position

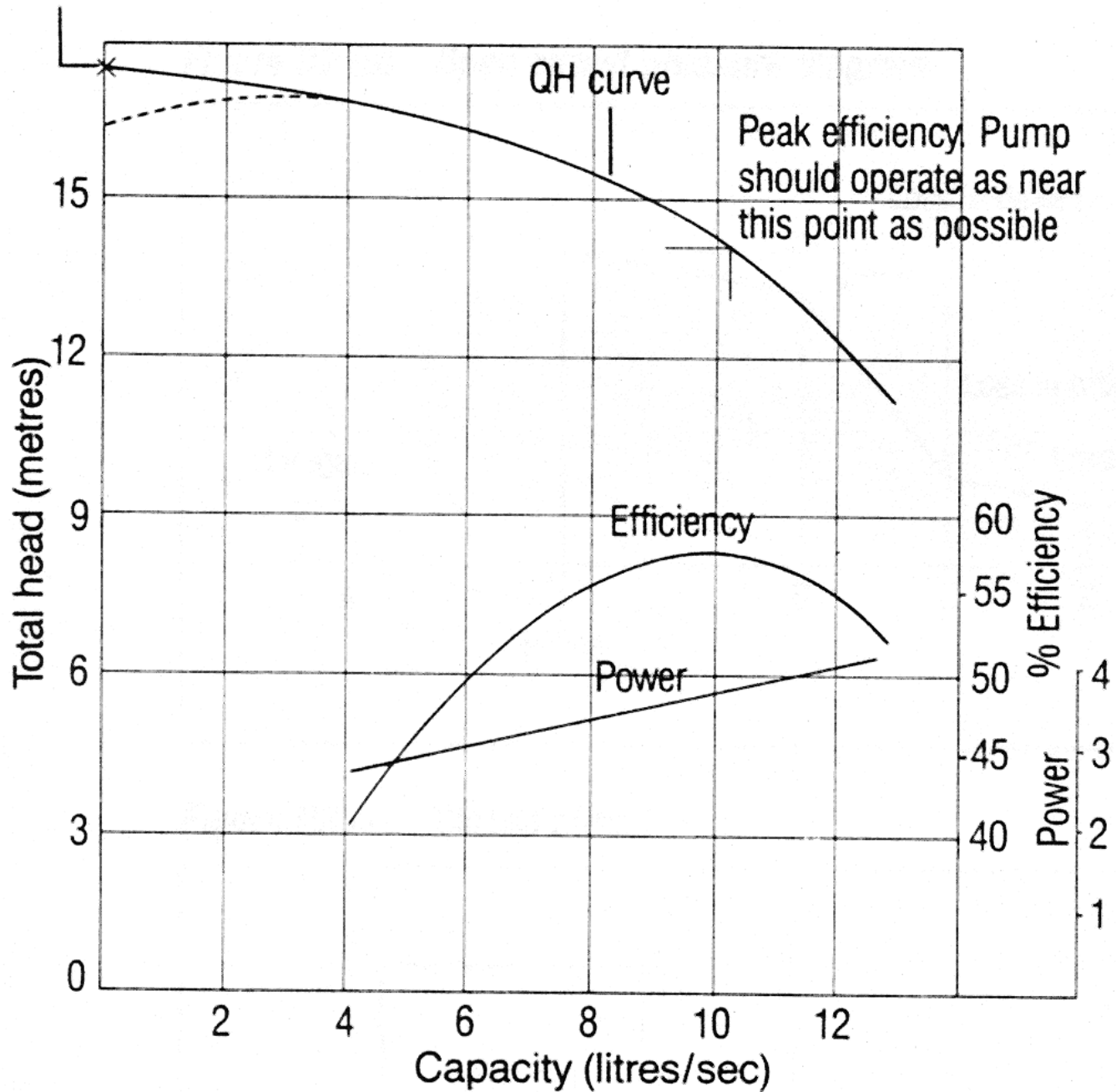

Pump curve, system curve and point of operation

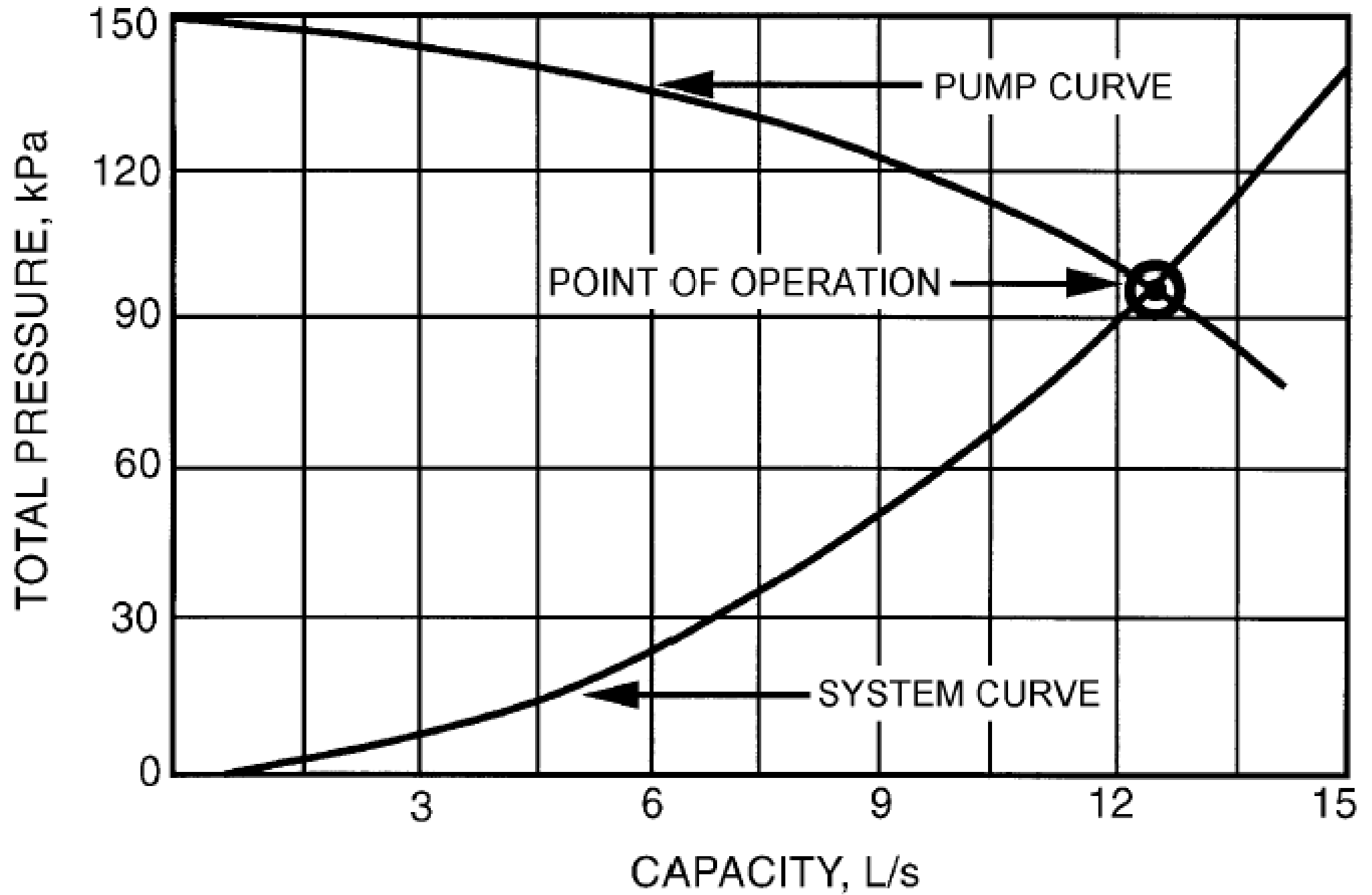

Characteristic curves for pump models

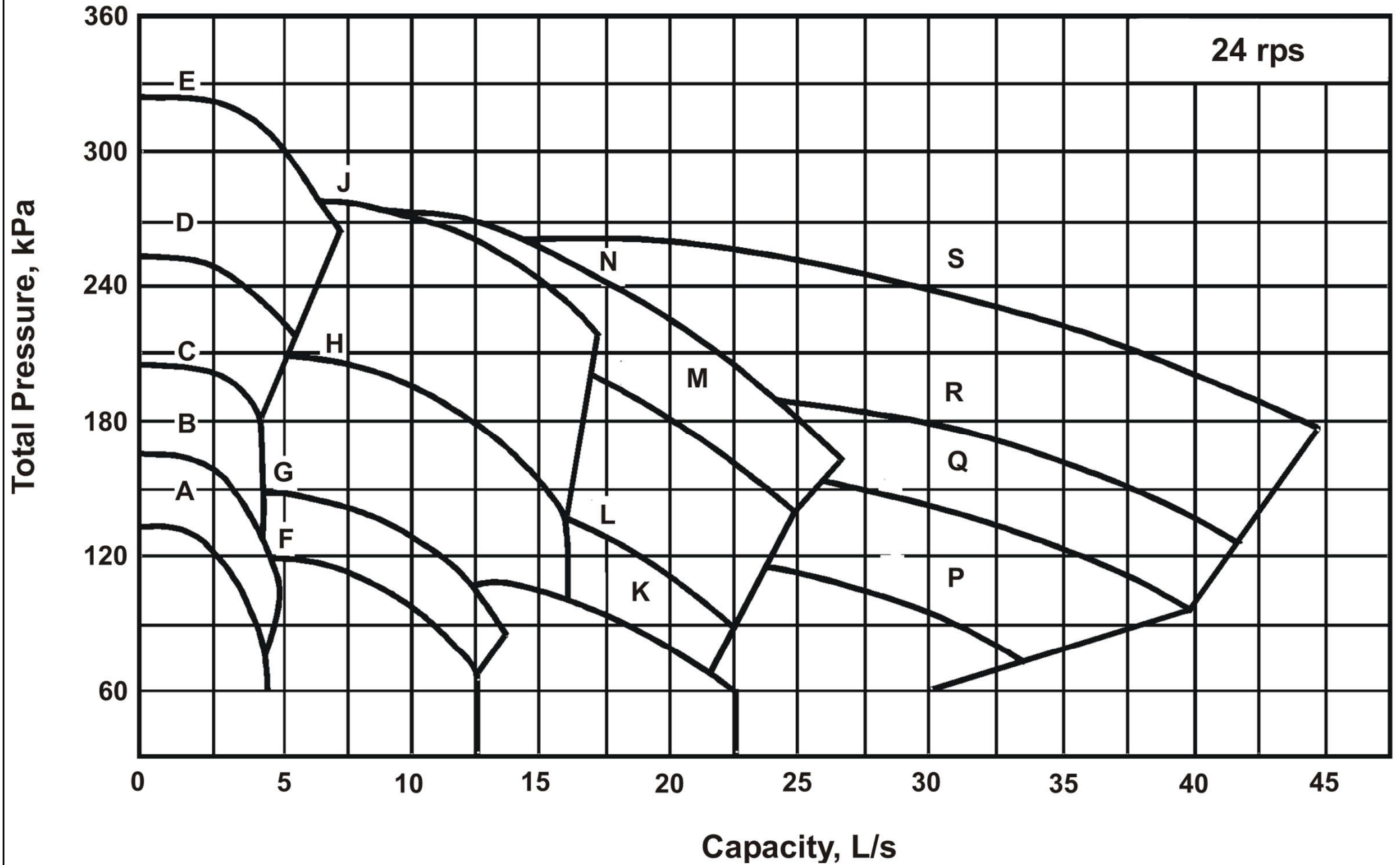

Selected pump pressure-capacity curve

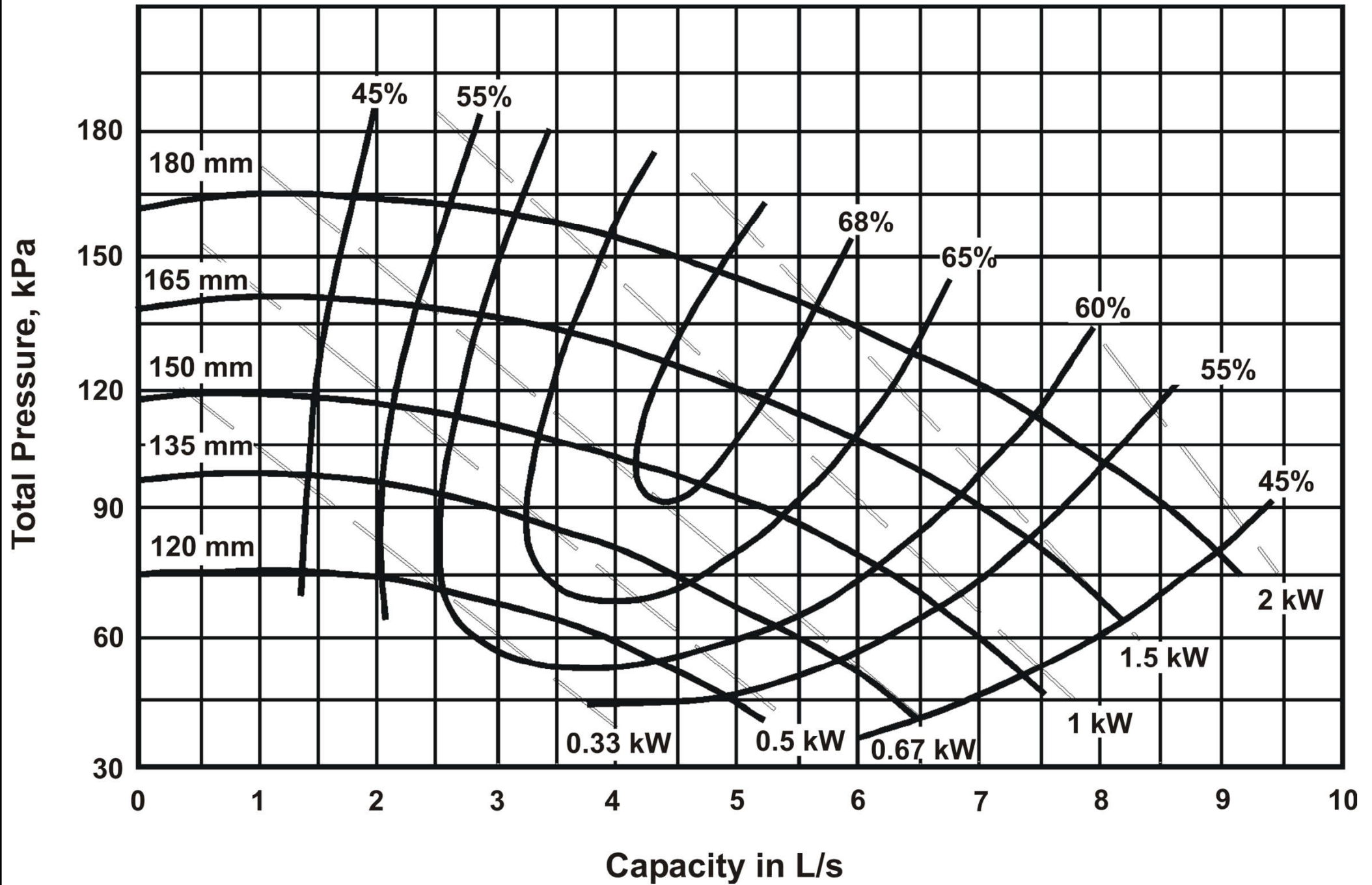

Pump systems



- Pump characteristics (cont'd)
 - Pumps with steep characteristics
 - Change in pressure \rightarrow small change in flow rate
 - Useful where pipes tend to scale up
 - Pumps with flat characteristics
 - Change in flow \rightarrow small change in pressure
 - Useful where extensive hydraulic balancing is needed

Flat versus steep pump curves

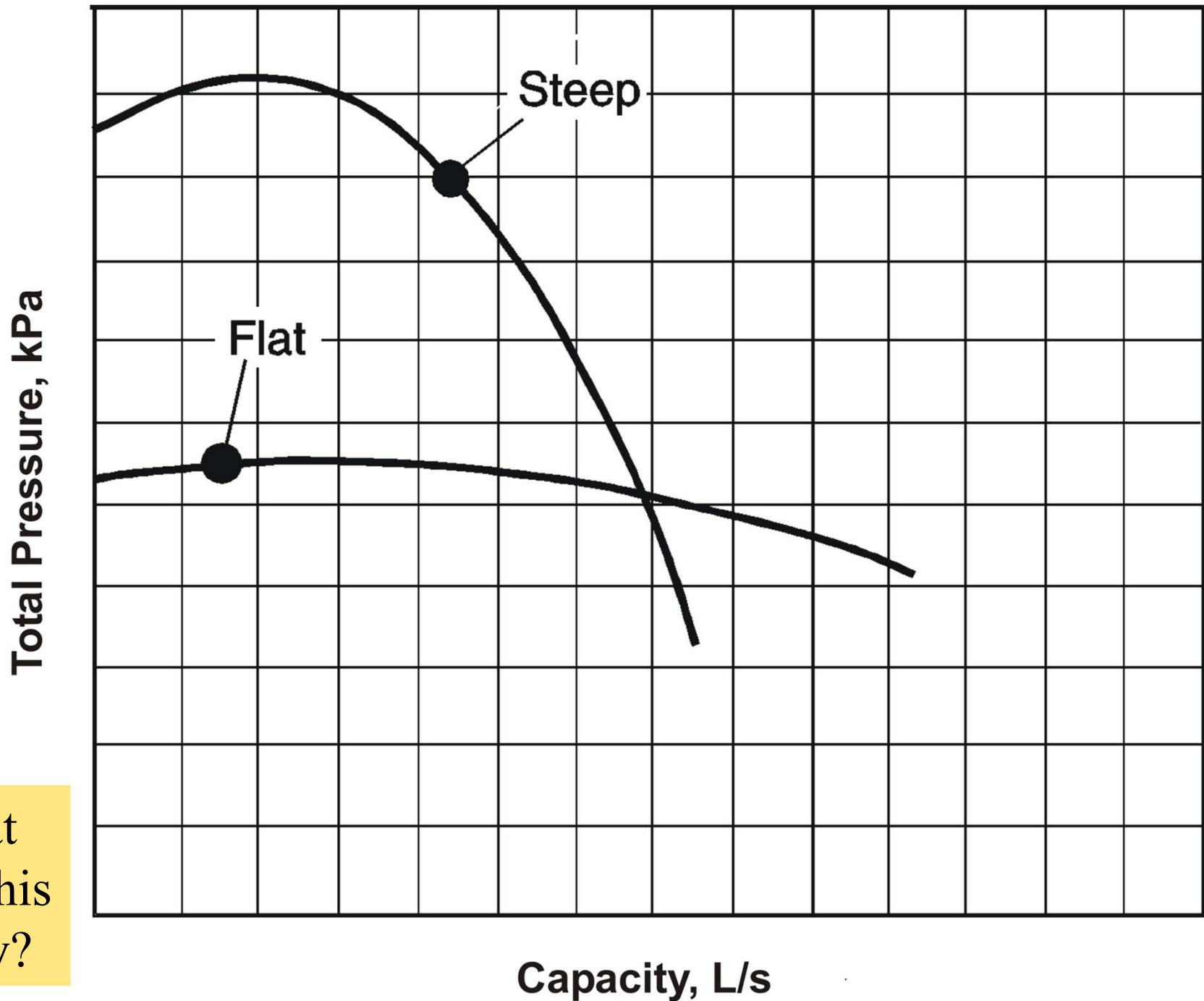

What does this imply?

Pump systems



- Pump characteristics (cont'd)
 - Pumps with constant speed cannot respond to changes in load
 - Require a bypass to ensure constant flow
 - Variable speed pumps
 - Provides for savings in pumping costs during partial load
 - Pump materials to suit the environment, e.g. stainless steel pumps for salt water system



Further Reading

- Application for Water Supply in HK
<https://www.wsd.gov.hk/en/customer-services/application-for-water-supply/>
- IOP, 2002. Plumbing Engineering Services Design Guide, [New ed.], Institute of Plumbing (IOP), Hornchurch, Essex, UK.
<http://docshare04.docshare.tips/files/24329/243291973.pdf>
 - Hot and cold water supplies, p. 1-23
 - Pumps and pumping, p. 161-168

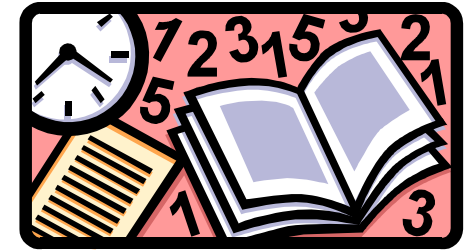

References

- Garrett, R. H., 2008. *Hot and Cold Water Supply*, 3rd ed., Chichester, West Sussex, U.K.
- Hall F. & Greeno R., 2017. *Building Services Handbook*, 9th ed., Routledge, Oxon & New York.
- WSD, 2021. *Technical Requirements for Plumbing Works in Buildings (December 2021 version)*, Water Supplies Department (WSD), Hong Kong. <https://www.wsd.gov.hk/en/plumbing-engineering/requirements-for-plumbing-installation/technical-requirements-for-plumbing-works-in-bldgs/>
- WSD, 2018. *Handbook on Plumbing Installation for Buildings*, Water Supplies Department (WSD), Hong Kong. <https://www.wsd.gov.hk/en/plumbing-engineering/requirements-for-plumbing-installation/handbook-on-plumbing-installation/>