



## Sanitation and Drainage



*Ir Dr. Sam C. M. Hui*

Department of Mechanical Engineering

The University of Hong Kong

E-mail: [cmhui@hku.hk](mailto:cmhui@hku.hk)

# Contents

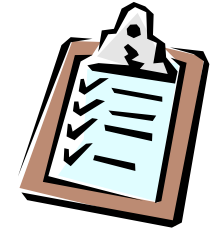

- Design concepts
- Basic principles
- Sanitary drainage
- Stormwater drainage
- Important issues

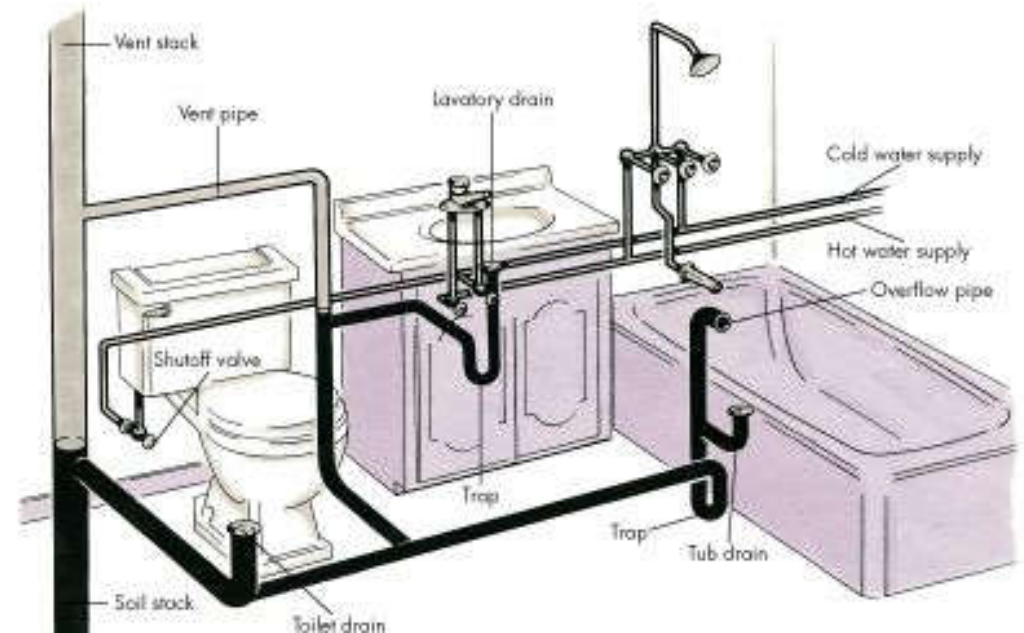

# Design concepts



- Design of drainage systems
  - Sanitary fitments
  - Above ground drainage
  - Below ground drainage (+ sewage disposal)
- Aim: To remove waste, foul & surface water
  - Waste water (廢水) = basins, sinks, baths, showers
  - Soil or foul water (穢水) = from toilets or W.C.
  - Surface water (地面水) = rainwater or stormwater
- Systems will last as long as the building!!

# Basic concepts of sanitary plumbing & drainage systems

Plumbing system (water supply)

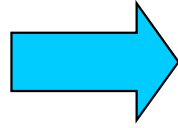

Sanitary fitments

Rainfall, surface water & stormwater

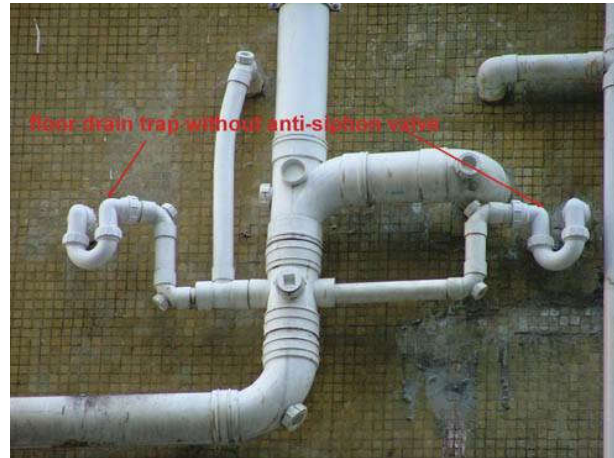
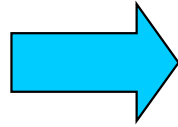

Above ground drainage

Sometimes, sump & pump system is required for disposal e.g. in basement

Below ground drainage

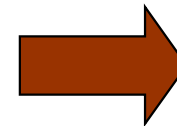

Sewage disposal (and treatment)



# Design concepts



- Objectives
  - Maintain healthy conditions in the building
  - Remove effluent quickly & quietly
  - Free from blockage, durable and economic
- Blockages may occur when
  - It is overloaded with solids
  - It suffers restricted flow at some bends or joints
- Thus, each discharge pipe section must be accessible for inspection & internal cleaning

# Design concepts



- Sanitary fittings or appliances
  - Common types:
    - Flushing cistern, flushing trough, automatic flushing cistern, flushing valve
    - Water closets (W.C.), urinal, bidets
    - Shower and bath tub
    - Sink, cleaner's sink
    - Drinking fountain
    - Wash basin or washing trough
    - Floor drain

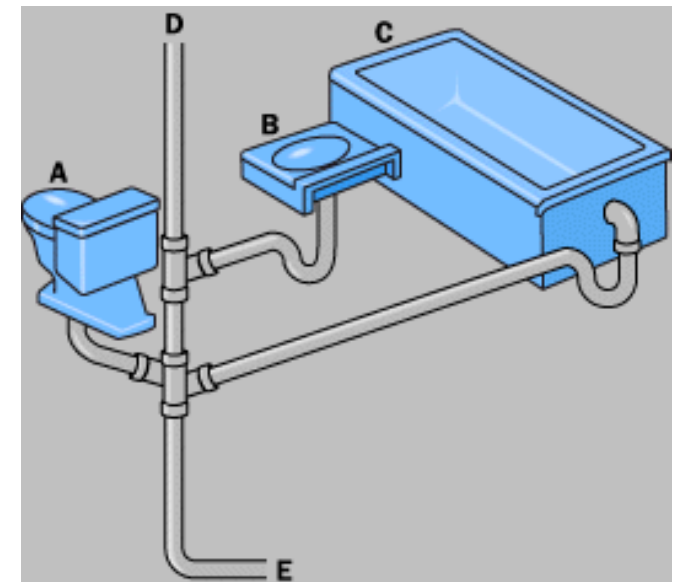

# Design concepts



- Sanitary fittings or appliances (cont'd)
  - Materials used : (do you know why?)
    - Ceramics, glazed earthenware, glazed fireclay, glazed stoneware, vitreous china, pressed metal, acrylic plastic (Perspex), glass-reinforced polyester, cast iron and terrazzo

- Practical examples:

- [www.americanstandard-us.com](http://www.americanstandard-us.com)
- [www.thebluebook.co.uk](http://www.thebluebook.co.uk)
- [www.totousa.com](http://www.totousa.com)



# Design concepts



- Sanitation statutory requirements in HK:

- Building (Standards of Sanitary Fitments, Plumbing, Drainage Works and Latrines) Regulations (Cap 123 i)

<https://www.elegislation.gov.hk/hk/cap123I>

- Residential buildings
- Workplaces
- Places of public entertainment
- Sports stadia
- Cinemas, shopping arcades, etc.
- Restaurants





## Example: Standards of sanitary fitments for workplaces

Number of male persons in workplace	Number of watercloset fitments	Number of urinals
Not more than 10	1	Nil
11–100	1 for every 25 male persons or part of those persons 50 such persons, or part thereof, over 100	1 for every 50 male persons or part of those persons
More than 100	4 plus 1 for every 50 male persons, or part of those persons, over 100	2 plus 1 for every 50 male persons, or part of those persons, over 100

Number of female persons in workplace	Number of watercloset fitments
Not more than 10	1
11-25	2
More than 25	2 plus 1 for every 25 female persons, or part of those persons, over 25

# Design concepts



- Sanitary provisions in HK:
  - Practice Notes for Authorized Persons, Registered Structural Engineers and Registered Geotechnical Engineers (PNAP)
    - ADV-28 Provision of Sanitary Fitments in Offices, Shopping Arcades, Department Stores, Places of Public Entertainment, Cinemas and Other Public Places (Nov 2012)  
<https://www.bd.gov.hk/doc/en/resources/codes-and-references/practice-notes-and-circular-letters/pnap/ADV/ADV028.pdf>
  - Building (Standards of Sanitary Fitments, Plumbing, Drainage Works and Latrines) (Amendment) Regulation 2015 <https://www.elegislation.gov.hk/hk/2015/ln191!en>

# Design concepts



- Sanitary provisions in HK: (Cont'd)
  - Male to female ratio
    - 1 : 1 for office accommodation
    - 1 : 1.5 for places of public entertainment, cinemas, etc.
  - Assessment of population\*
  - Provision of sanitary fitments\*
  - Sanitary fitments for use by children
  - Provision of unisex toilets (e.g. for caregivers)
  - Minimum space requirements for sanitary fitments in public places

\* See tables in PNAP ADV-28

# Design concepts



- Types of drainage pipes
  - Waste pipe (WP): e.g. connected to basins & baths
  - Soil pipe (SP): e.g. connected to W.C.
  - Ventilating/Vent pipe (VP)
  - Rain water pipe (RWP)
  - Anti-siphonage pipe: preserve water seals of traps
  - Air-conditioning condensation drainage pipe
- Use of traps (control foul gas or odour)
  - U-trap: a U-shaped running trap
  - P-trap and S-trap

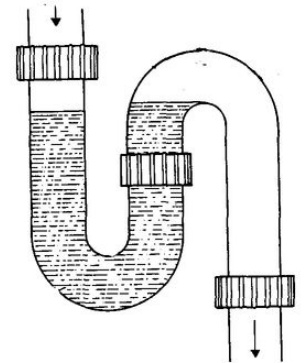

# Trap terminology

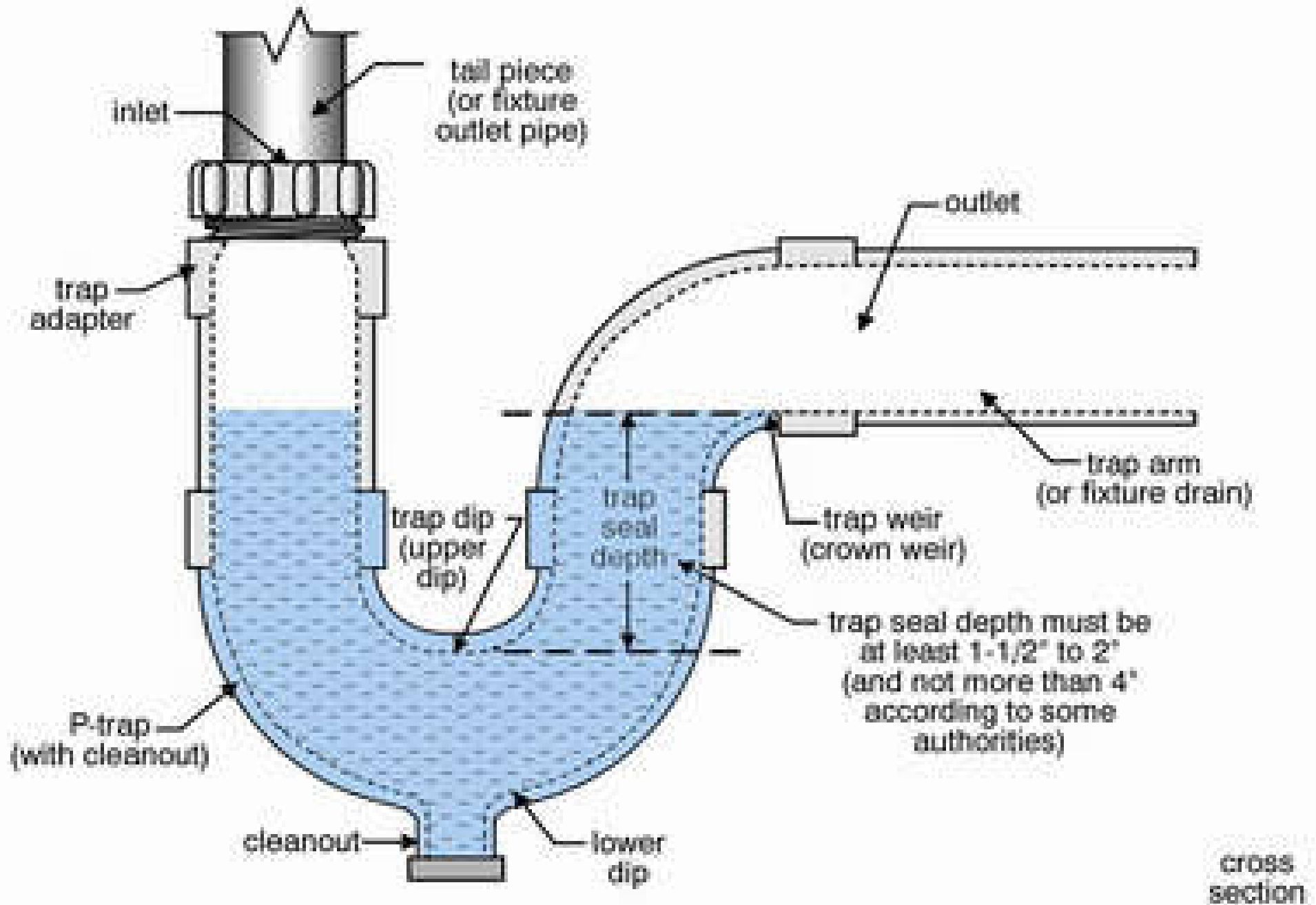

# Water seal of traps

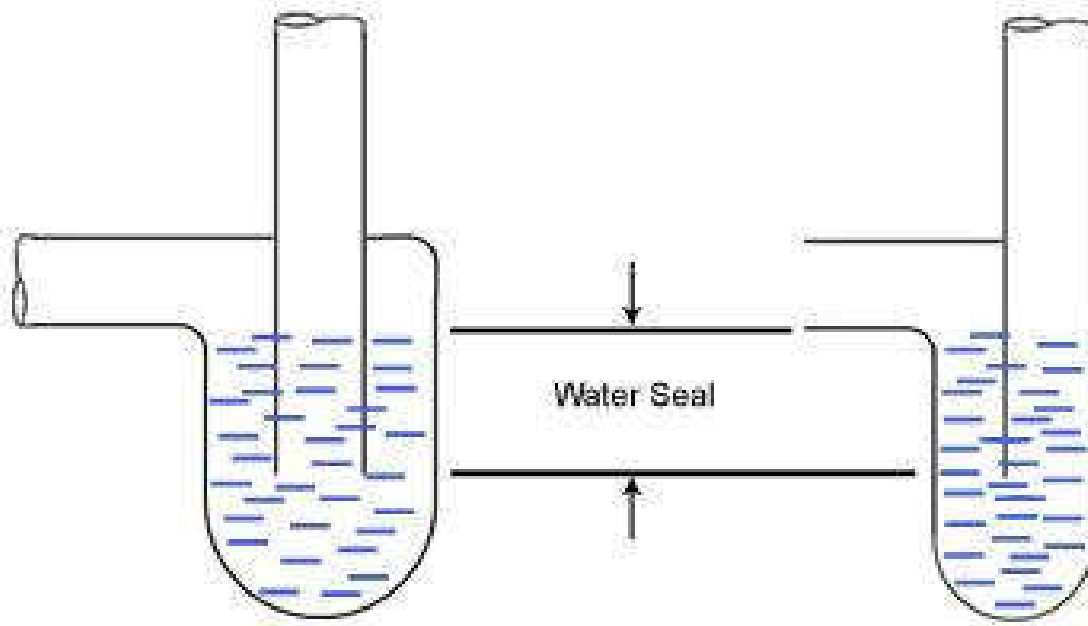

S-trap

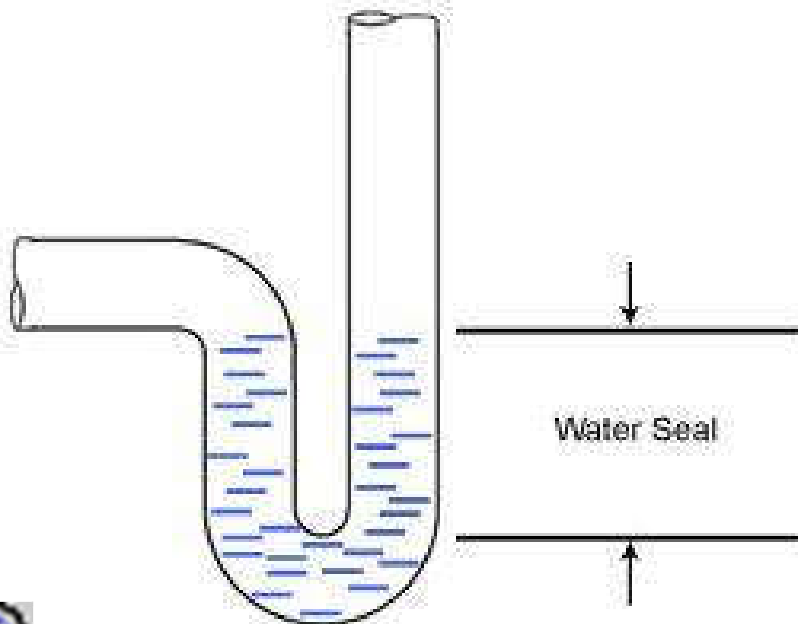

P-trap



## Minimum depth of trap seal

Use	Seal
Baths & showers which discharge to a stack	50 mm
Baths & showers located at ground floor level which discharge to a gully having a grating	38 mm
Wash basins with spray taps, and no outlet plugs	50 mm
Appliances with an outlet bore of 50 mm or larger	50 mm
All other appliances	75 mm

(Source: IOP, 2002. *Plumbing Engineering Services Design Guide*)

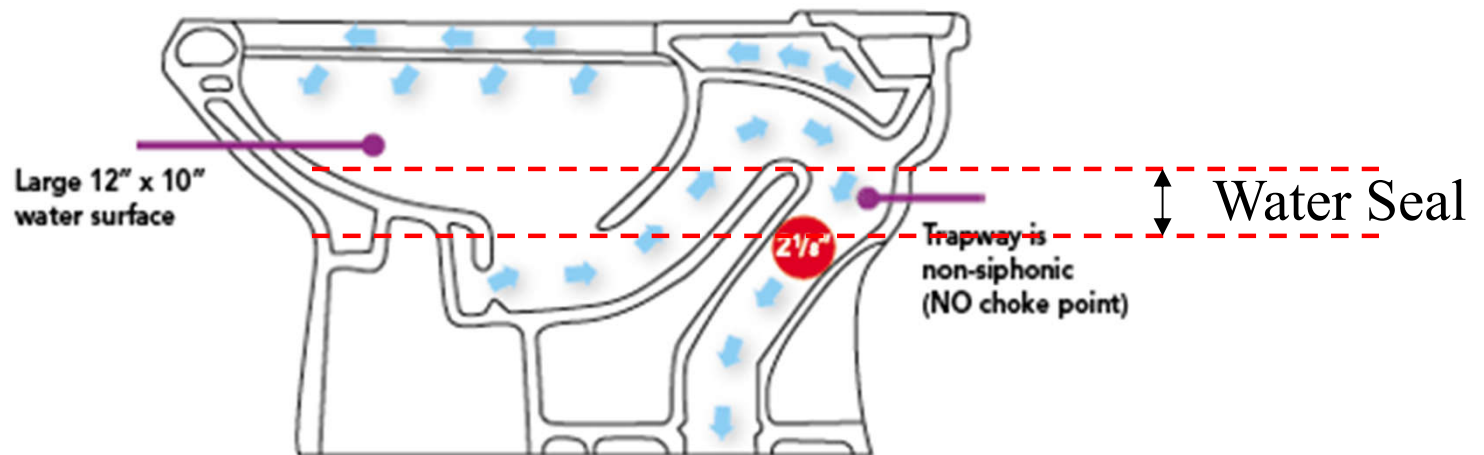

# Design concepts



- Types of sanitary drainage stack systems
  - Single stack system
  - Collar boss system
  - Modified single stack system
  - Fully ventilated one-pipe system
  - Two-pipe system
- Selection depends on situations, costs & local design practices
- Design considerations: e.g. pipe size, distance



## Single stack system

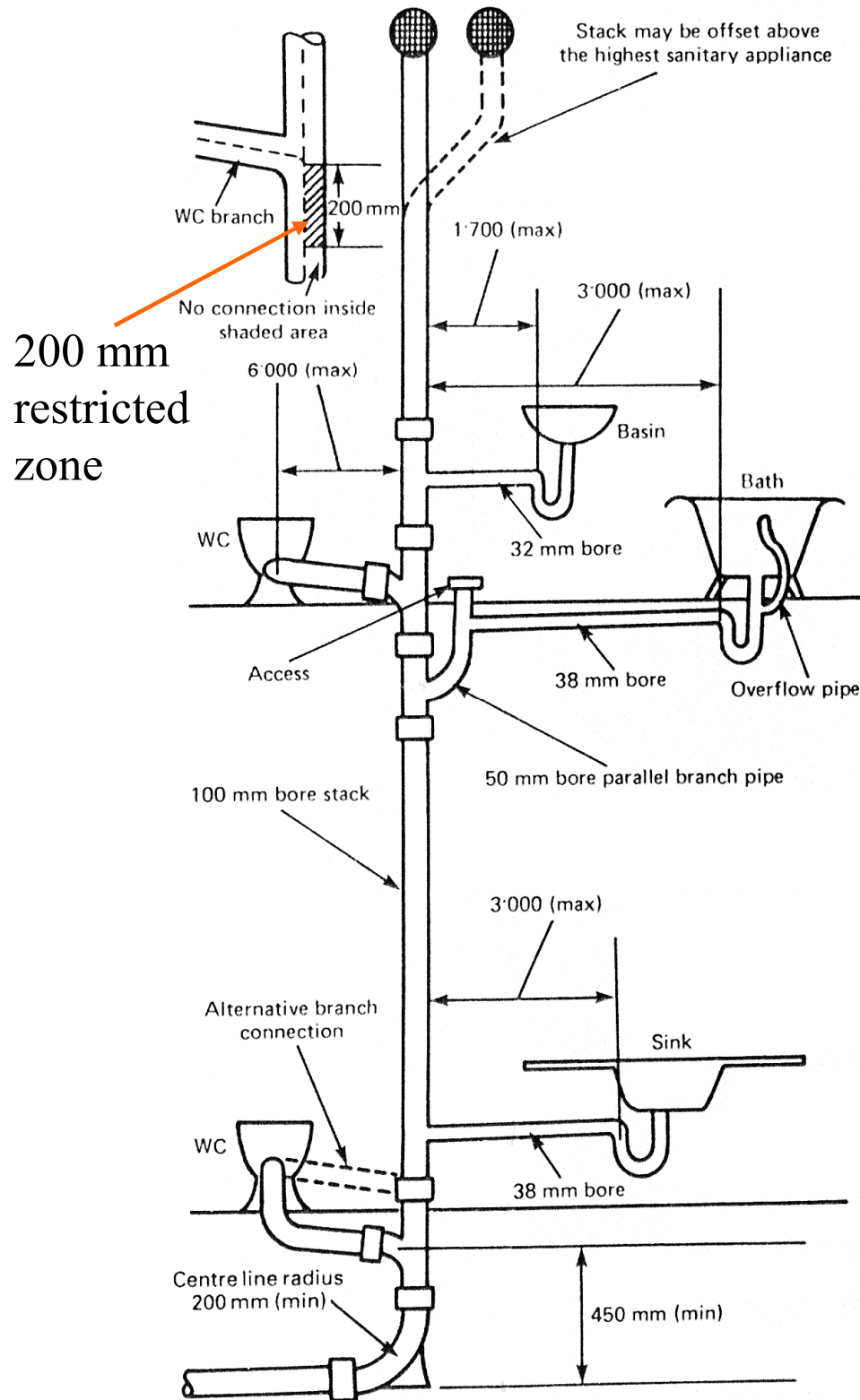

- Reduces the cost of soil and waste systems
- Branch vent pipes are not required
- But many restrictions in the design
- To prevent loss of trap water seals:-
  - The trap water seals on the waste traps must be 76 mm deep
  - The slopes of the branch pipes are: sink and bath, 18 to 19 mm/m; basin 20-120 mm/m; WC 18 mm/m (min.)
  - Vertical stack at 200 mm below the centre of the WC branch connection

## Collar boss single stack system

- Eliminates the restrictions imposed between bath waste pipe and stack
- Bath waste connect to the stack at a higher point (no risk of WC discharge backing up into bath waste pipe)
- Loop vent pipes to the basin/sink traps and connecting these to the collar boss, the waste pipes from these appliances drop vertically before running horizontally to stack
- Loop vent pipe on the basin trap prevent its siphonage when the bath is discharged
- Loop vent pipe on the sink trap prevent its siphonage when the sink is discharged

Annular chamber protects the small diameter connections from the WC discharge

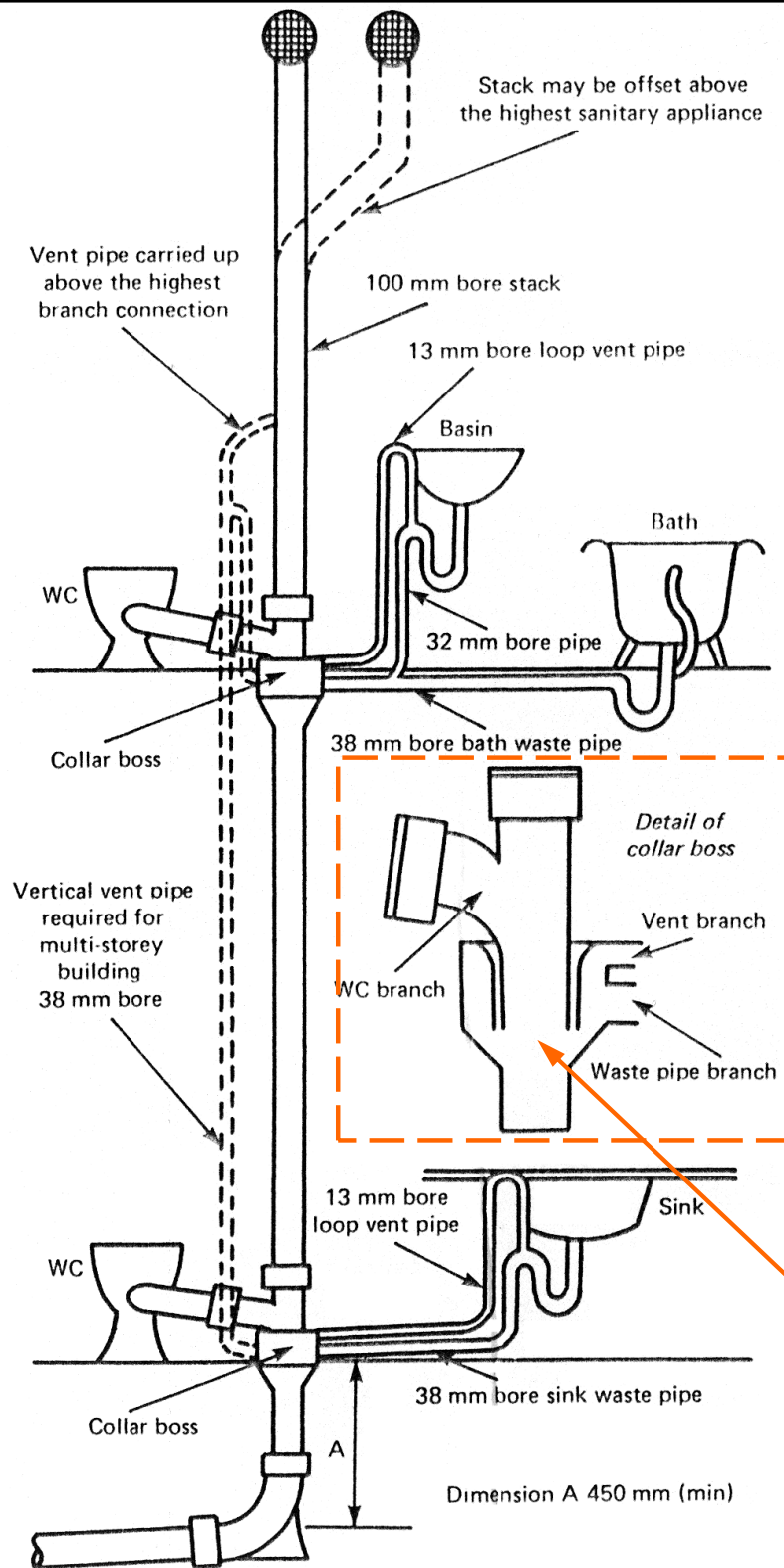

## Modified single stack system

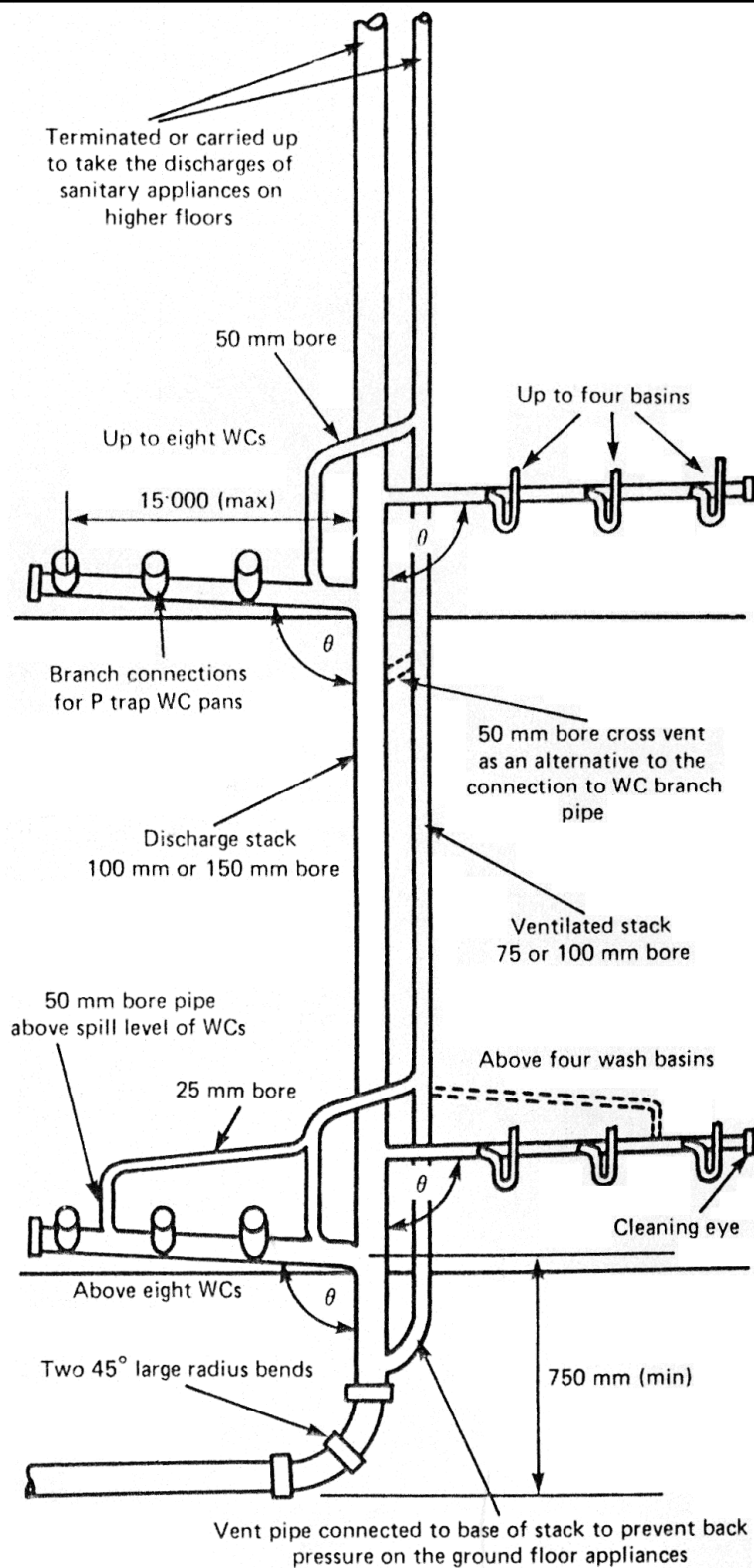

- Close grouping of sanitary appliances → install branch waste and soil pipes without the need for individual branch ventilating pipes
- To prevent the loss of trap water seals → WC branch pipe min. 100 mm bore & angle  $\theta = 90.5^\circ - 95^\circ$
- To prevent the loss of trap water seals → basin main waste pipe min. 50 mm bore & angle  $\theta = 91^\circ - 92.5^\circ$
- Five basins or more / length of the main waste pipe exceeds 4.5 m → a 25 mm bore vent pipe connected to main waste pipe at a point between the two basins farthest from the stack

## Fully ventilated one-pipe system

- A large number of sanitary appliances in ranges
- Each trap with an anti-siphon or vent pipe connected to the discharge pipe in direction of the flow of water at a point between 75 - 450 mm from trap crown
- Vent stack connected to the discharge stack near to the bend to remove compressed air at this point

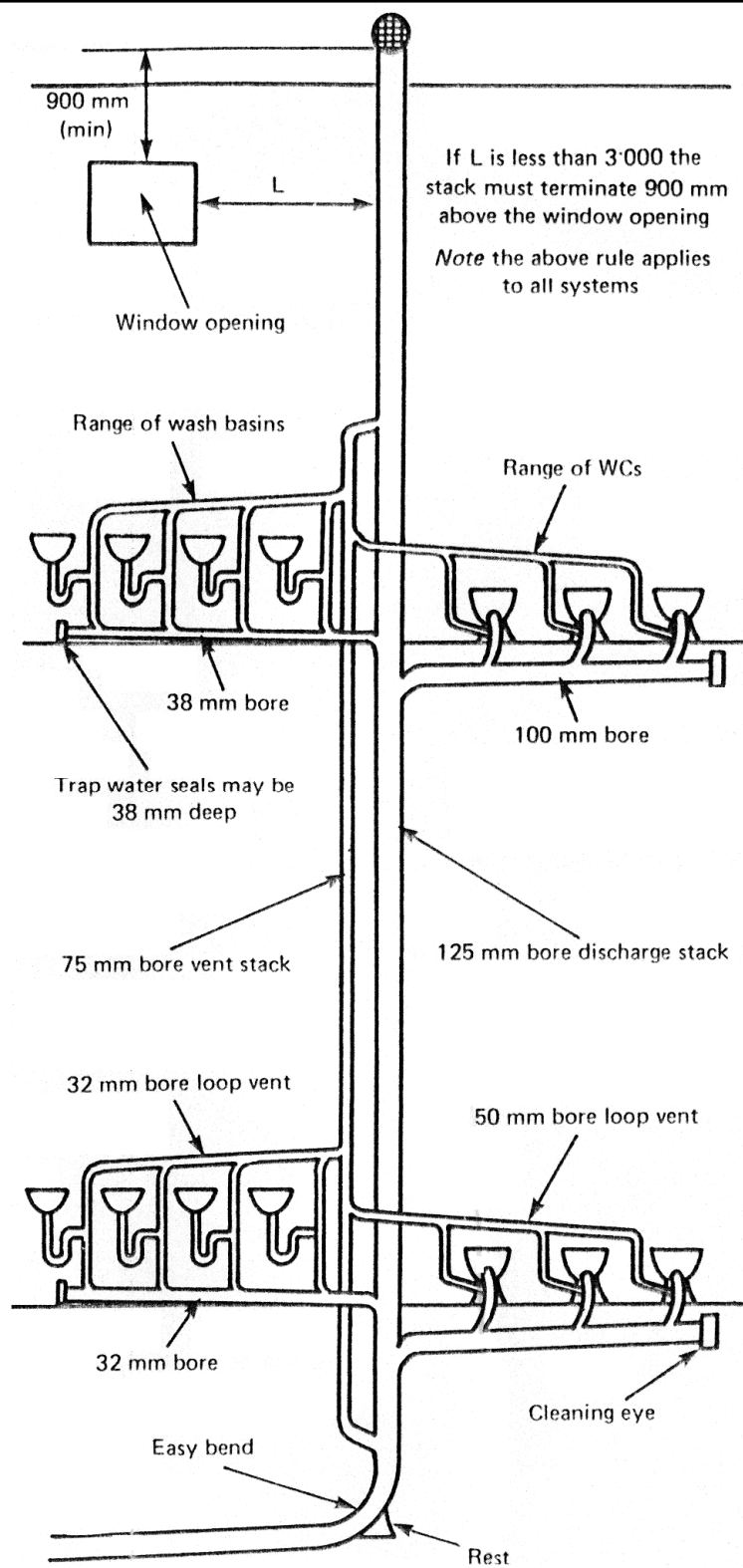

## Two-pipe system

- The most expensive and in case with widely spaced sanitary appliances
- Wash basins or sinks in rooms far away from main soil stack → to connect these appliances to a separate waste stack
- The waste stack connected to the horizontal drain either via a rest bend

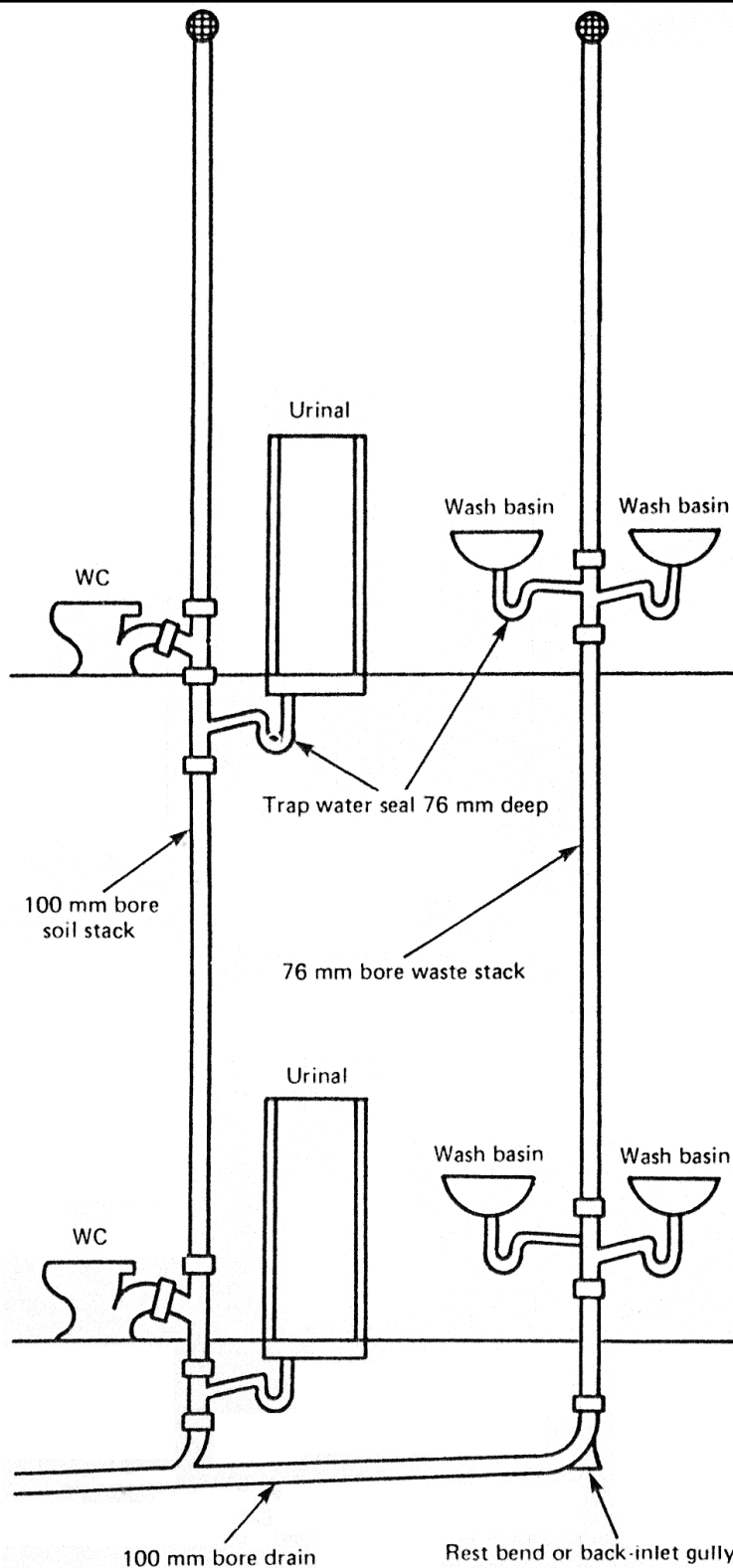

# Basic principles



- Principles of fluid flow in drainage pipes
  - Waste, soil or drain pipes
    - Discharge: random occurrence
    - Surges and pressure fluctuation
    - 2-phase flow (air + fluid) or 3-phase (air, fluid, solid)
  - Vertical soil and vent stacks
    - Open & ventilated on top, entrains air downwards
    - High air flow rate (10-15 l/s)
    - Friction losses, terminal velocity
    - Suction pressure at branch connection

Principles:  
Hydraulics (water)  
+ Pneumatic (air)

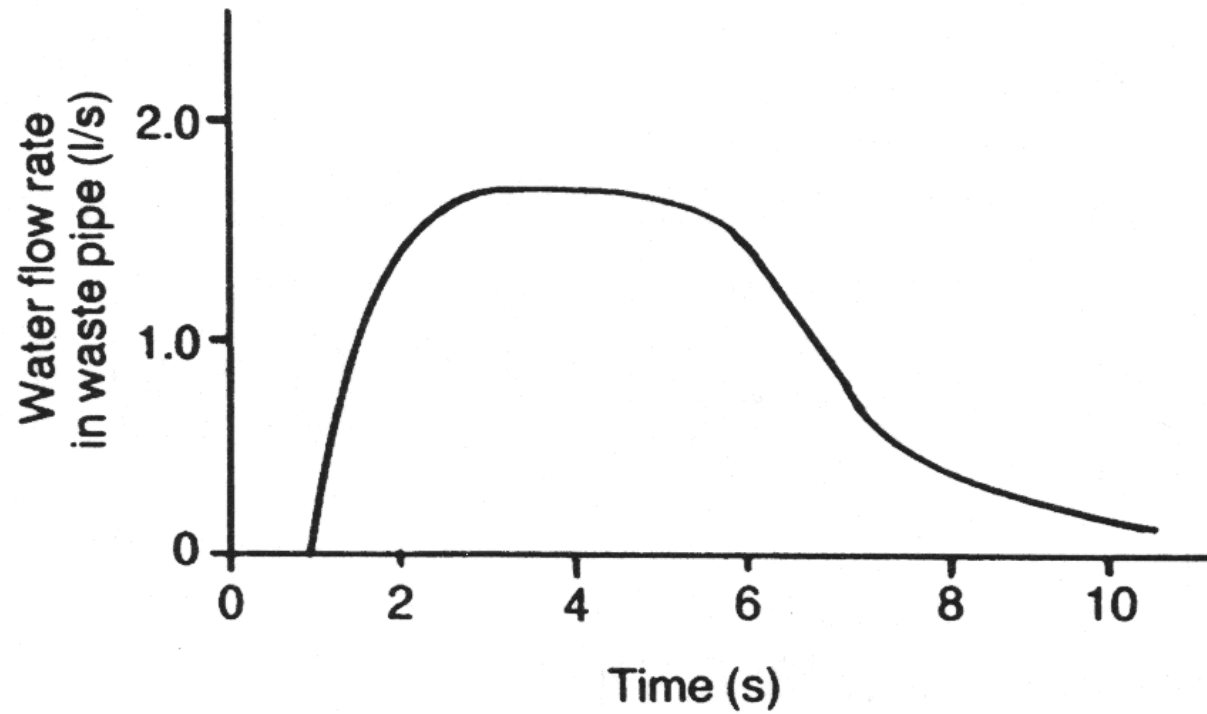

Discharge of water from a sanitary appliance

Design of a basin waste pipe to avoid self-siphonage

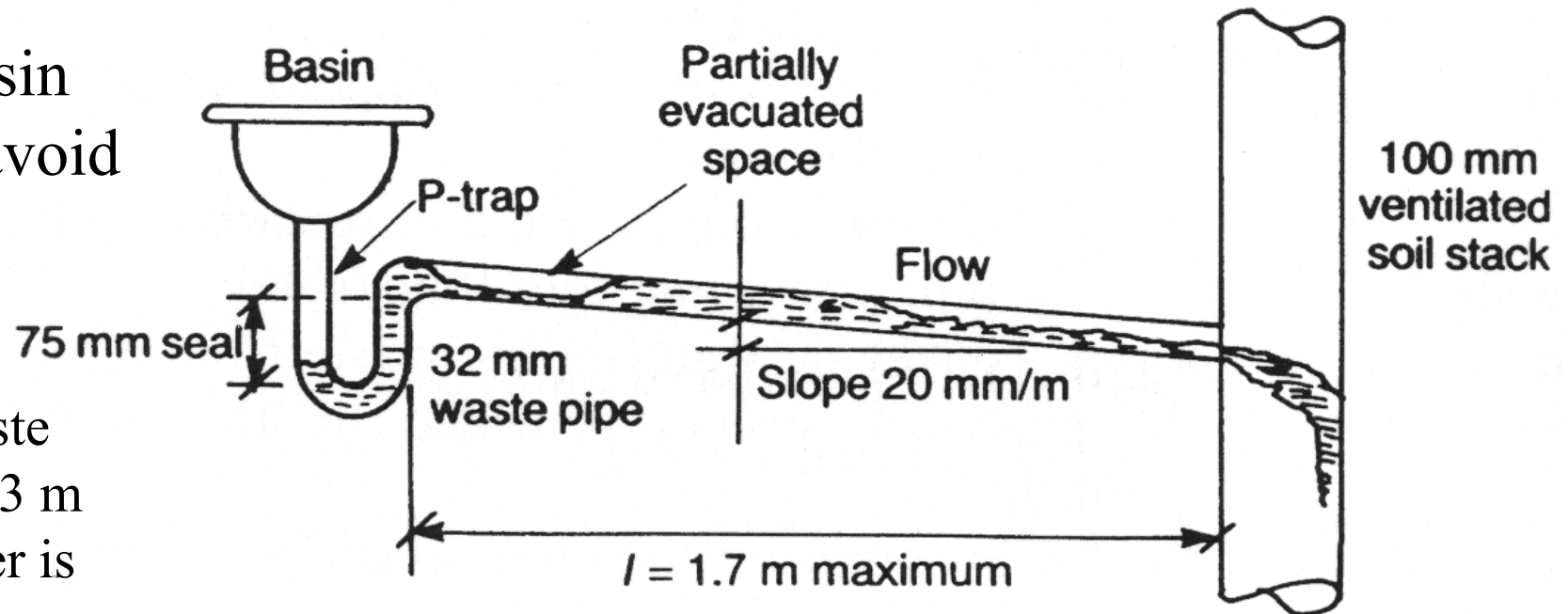

\* The sloping waste pipe can be up to 3 m long if its diameter is increased to 40 mm.

Longer waste pipe with bends and steeper or even vertical parts should have a 25 mm vent pipe.

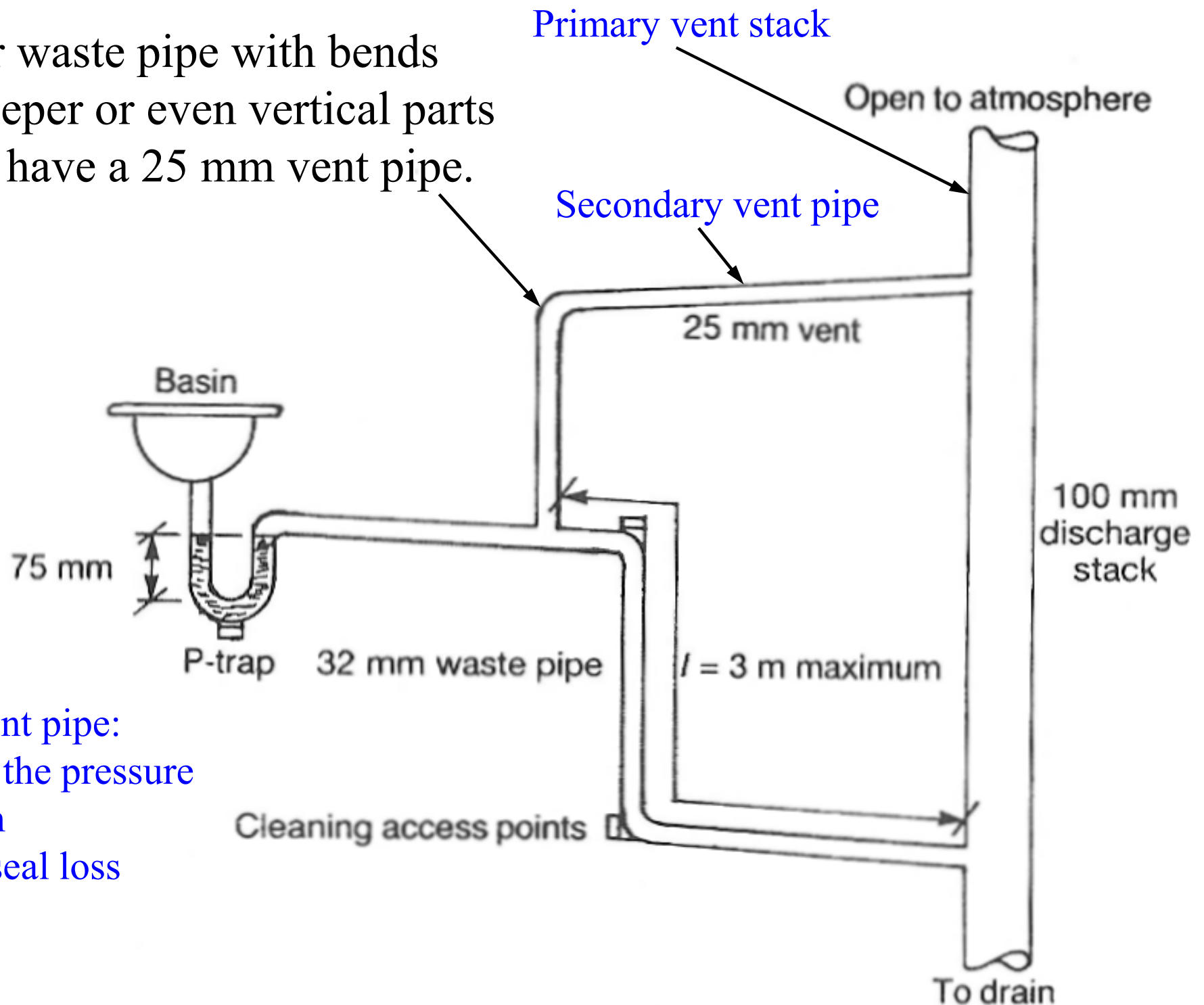

Uses of vent pipe:

- Equalise the pressure fluctuation
- Prevent seal loss



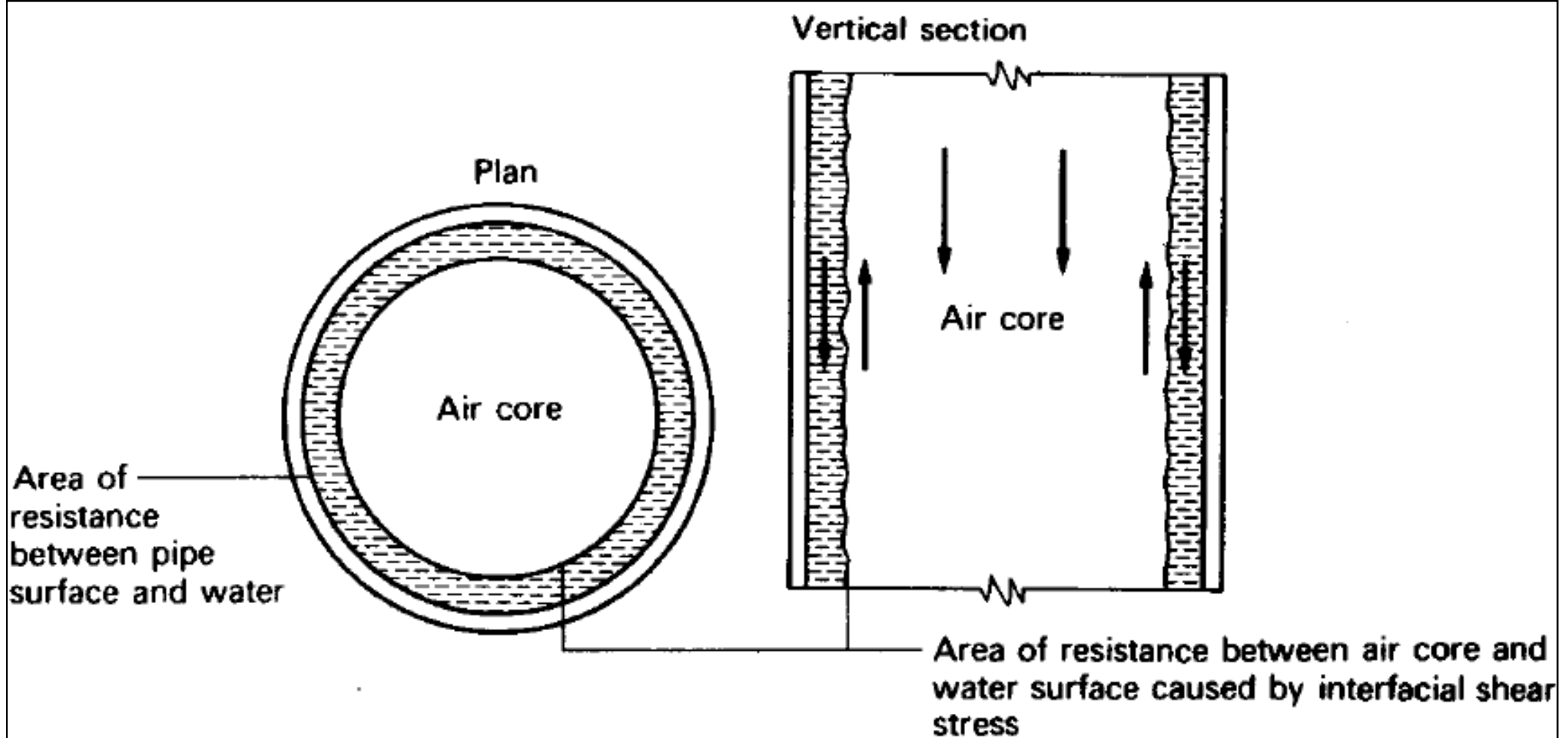

Terminal Velocity (when friction balances gravitational force)

$$V_T = 10.073 (Q/D)^{0.4}$$

$$L_T = 0.1706 \times V_T^2$$

where  $V_T$  is terminal velocity (m/s)

$Q$  is discharge rate (L/s)

$D$  is diameter of stack (mm)

$L_T$  is terminal length below point of entry (m)

# Pressure effects and seal losses due to water flow in a discharge stack

Open to atmosphere

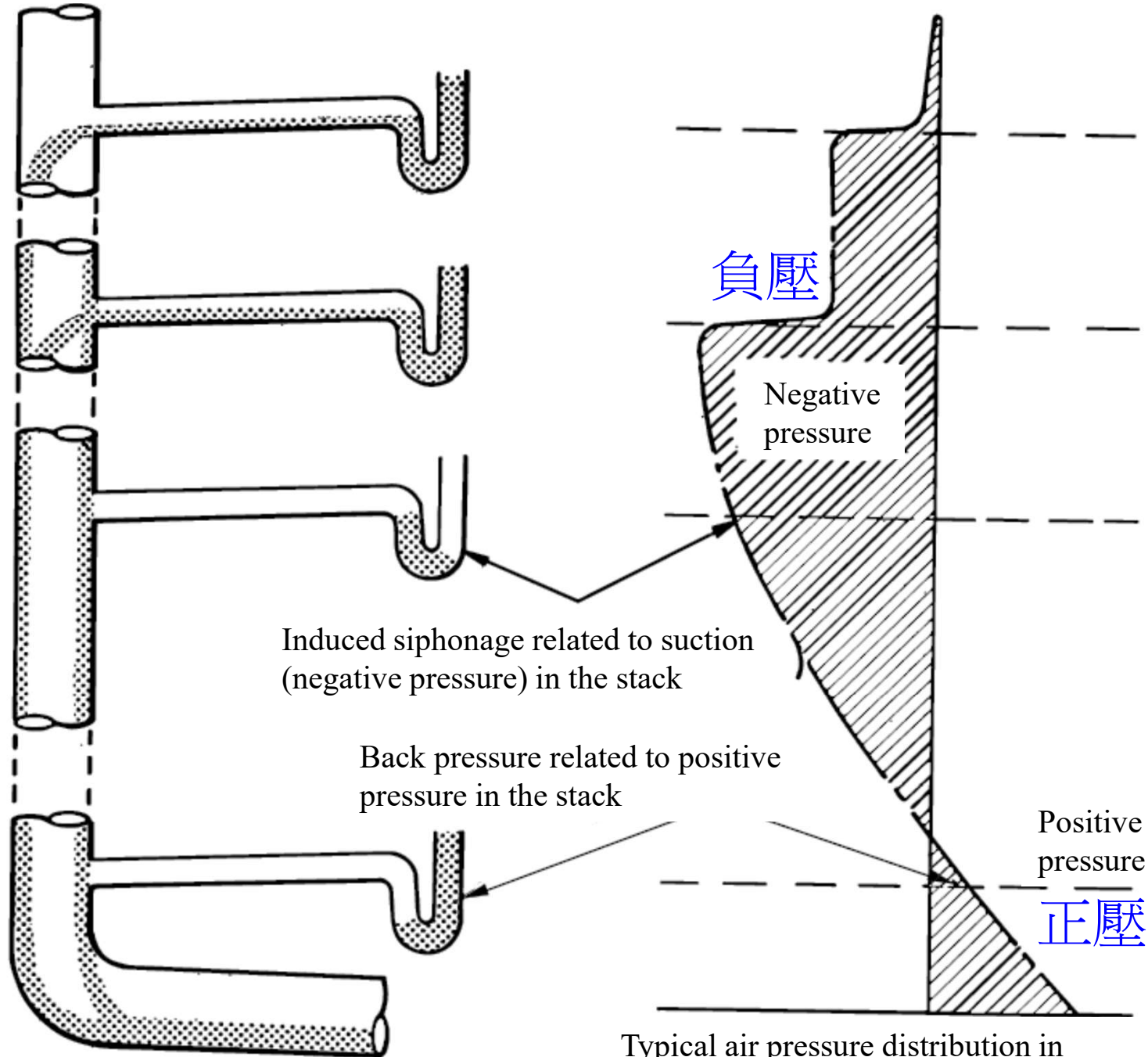

(Source: British Standard BS EN12056-2:2000)

Typical air pressure distribution in stack with two branches discharging

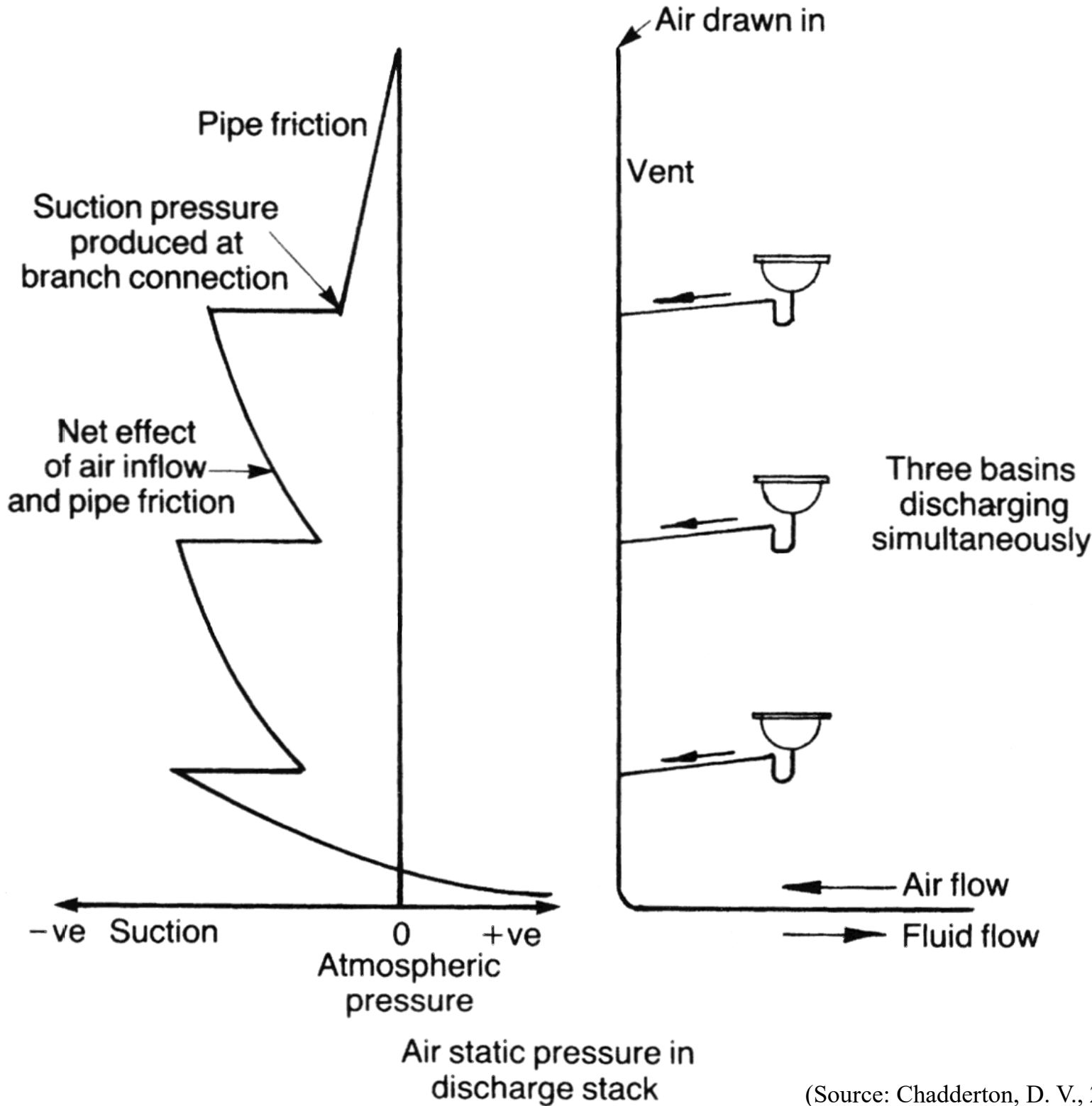

1. water discharged into the stack entrains air downwards
2. air static pressure is reduced by friction losses
3. water falls down as a helical layer attached to the pipe surface
4. restricted air passage at junctions further lowers the air static pressure
5. net effect of air inflow & pipe friction
6. at the stack base, air flow into the low pressure region
7. fluid fills the pipe near the base & positive air static pressure can be generated

(Source: Chadderton, D. V., 2007. *Building Services Engineering*)

# Methods of venting for a single stack system

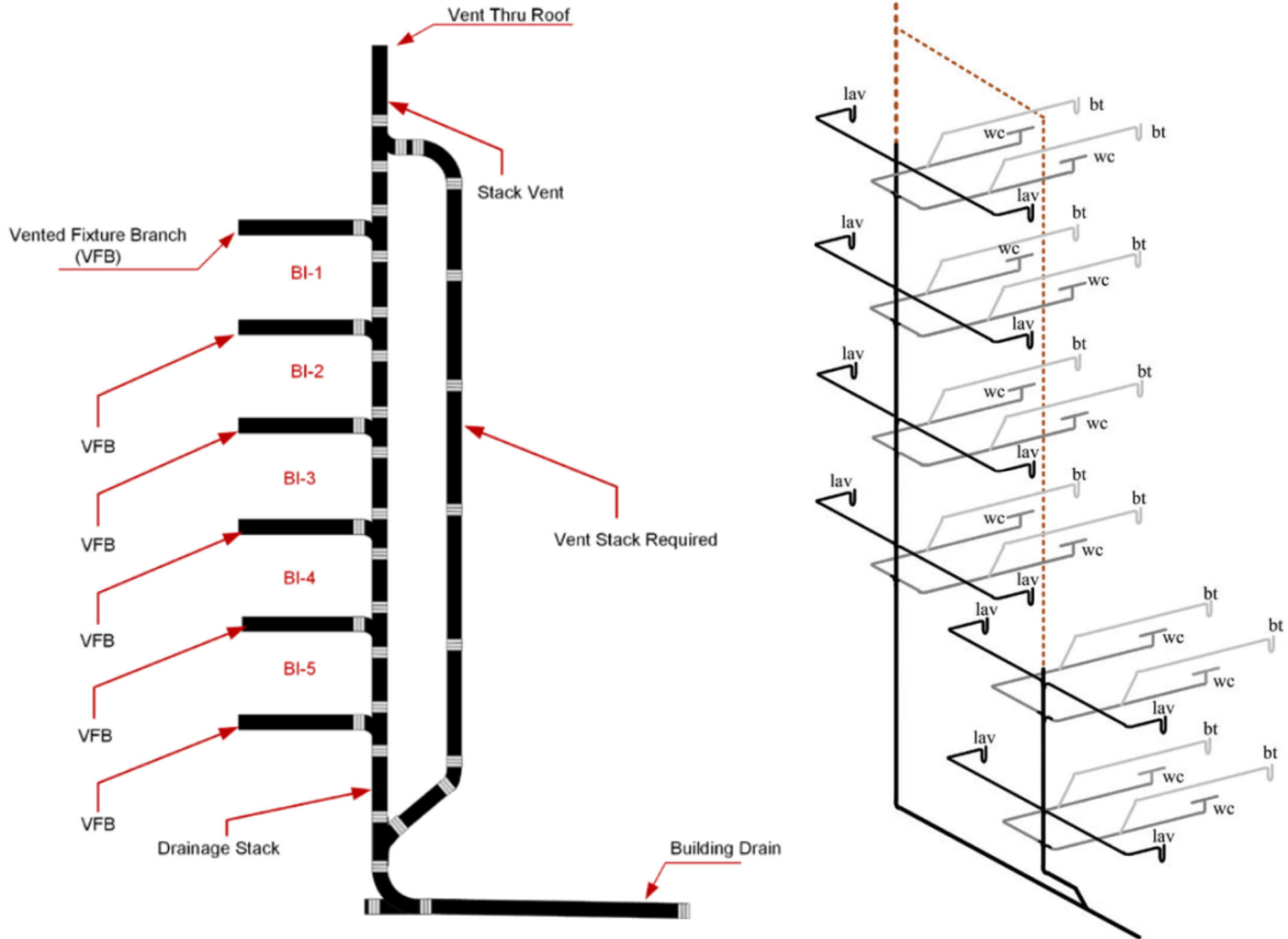

(Source: Clifton L., 2020. Methods of Venting Plumbing Fixtures and Traps in the 2021 IPC, International Code Council (ICC), Washington, DC. [https://www.iccsafe.org/wp-content/uploads/20-18927\\_GR\\_2021\\_Plumbing\\_Venting\\_Brochure.pdf](https://www.iccsafe.org/wp-content/uploads/20-18927_GR_2021_Plumbing_Venting_Brochure.pdf))

# Basic principles



- Loss of water seal can occur through:
  - Self-siphonage
  - Induced siphonage
  - Compression or back pressure
  - Capillary action
  - Wavering out
  - Other causes:
    - Evaporation, cross-flow, bends and offsets, surcharging, intercepting traps, leakage

## Self siphonage

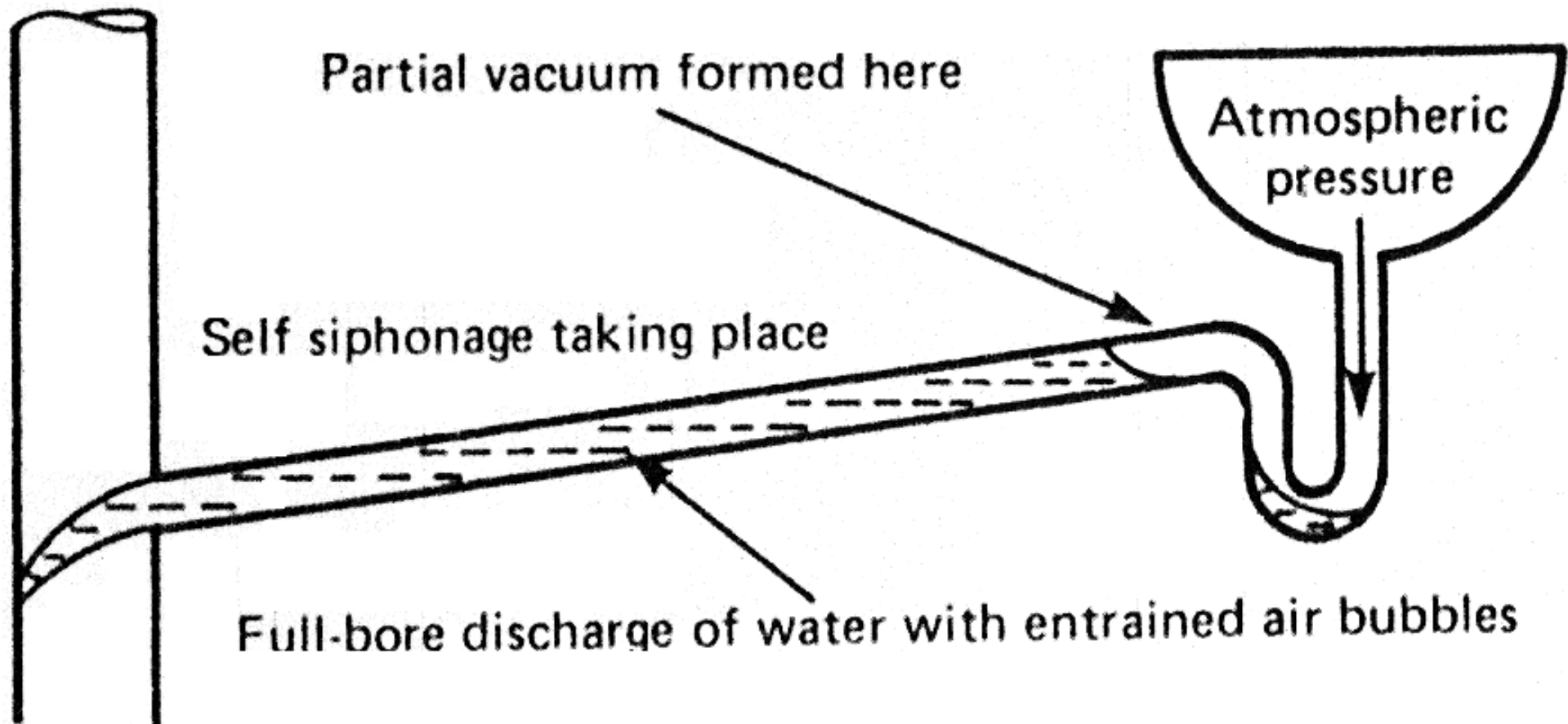

- Caused by: a moving plug of water in the waste pipe
- Avoided by: placing restrictions on lengths and gradients and venting long or steep gradients

## Induced siphonage

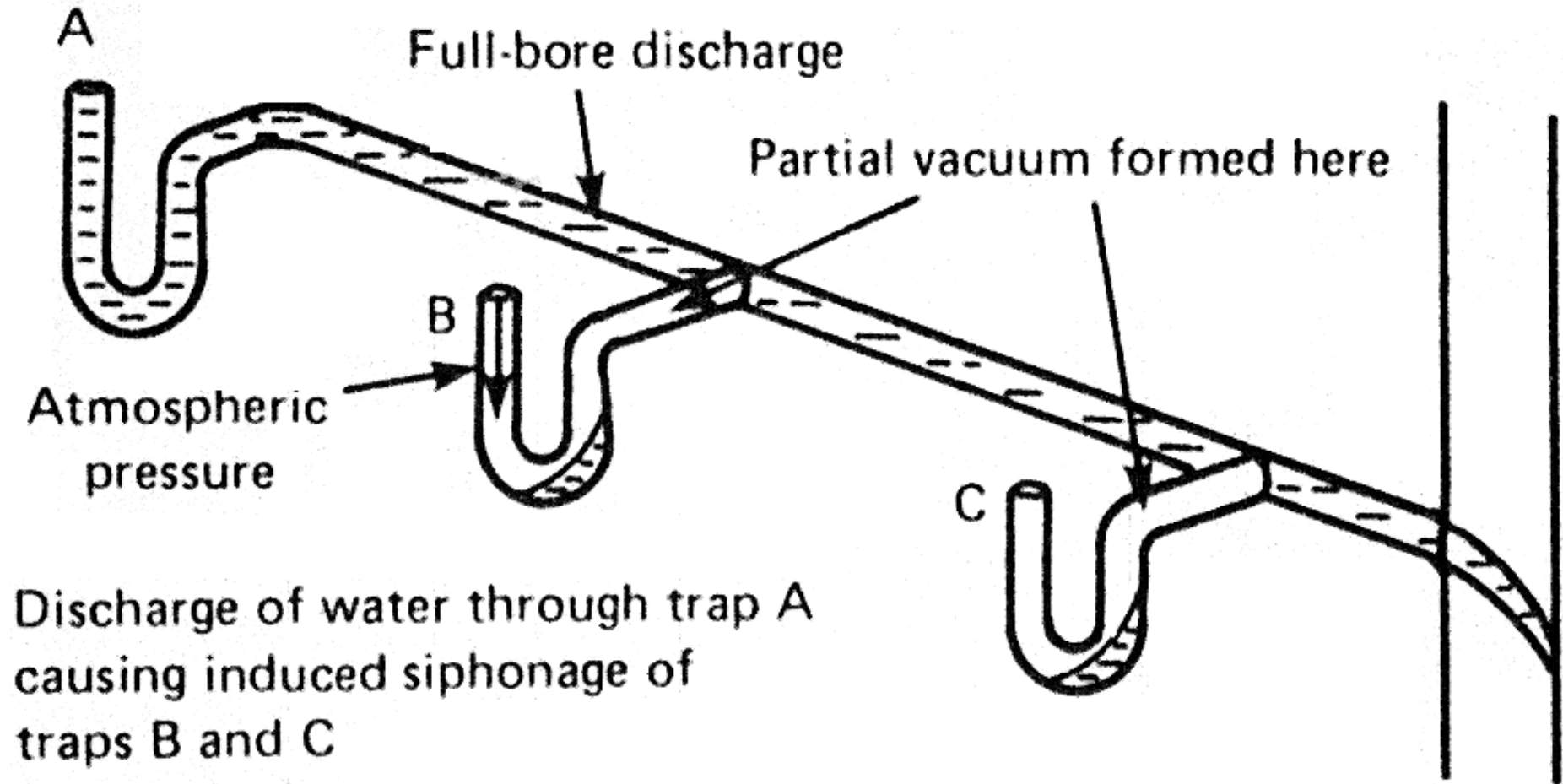

- Caused by: discharge from one trap
- Overcome by: design of the pipe diameters, junction layouts and venting arrangements

## Compression or back pressure

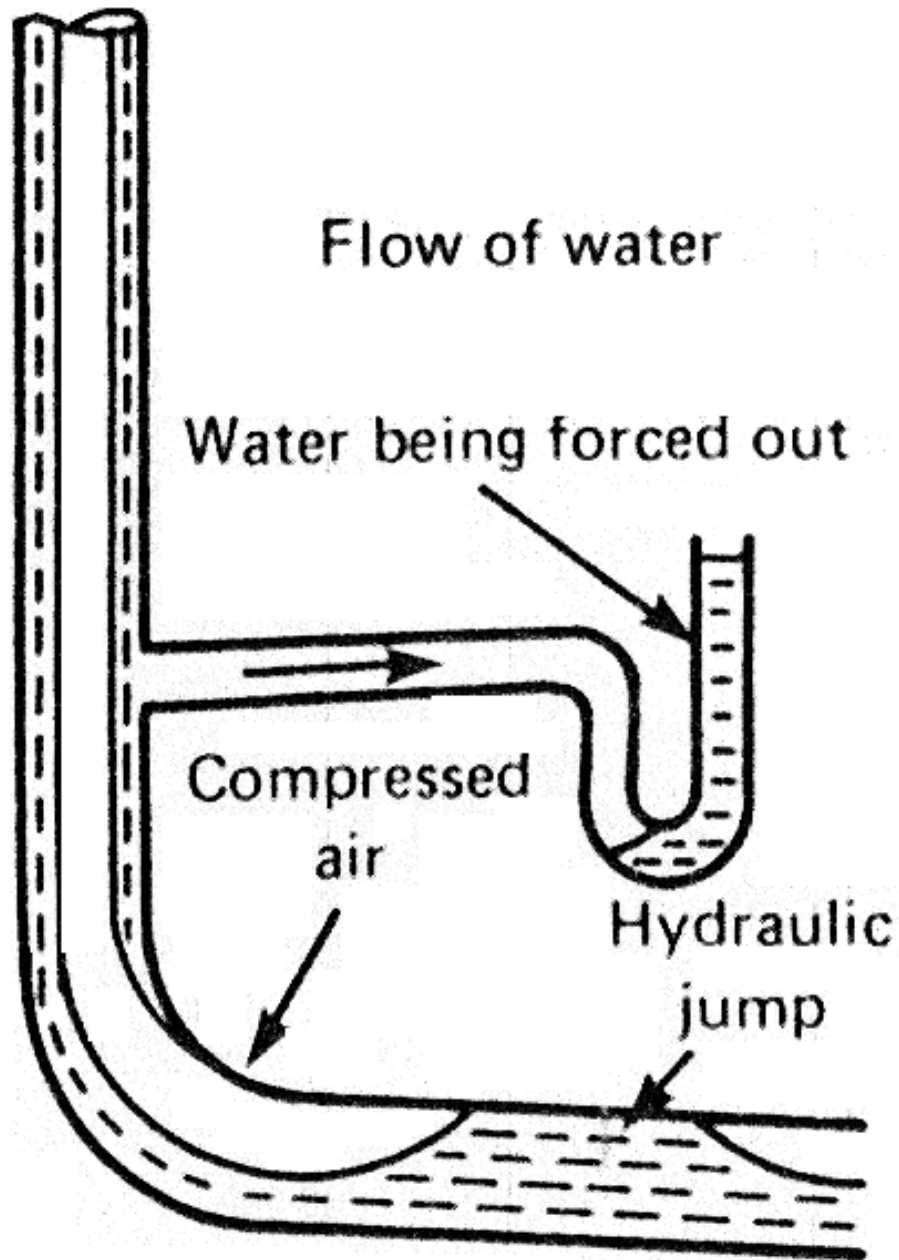

- Water flowing → compresses air in pipe → forces out the trap water seal

- Prevention: waste pipes not connected to the lower 450 mm of vertical stacks (measured from the bottom of the horizontal drain); waste discharges at the lower floors must be connected separately to drain



## Capillary action

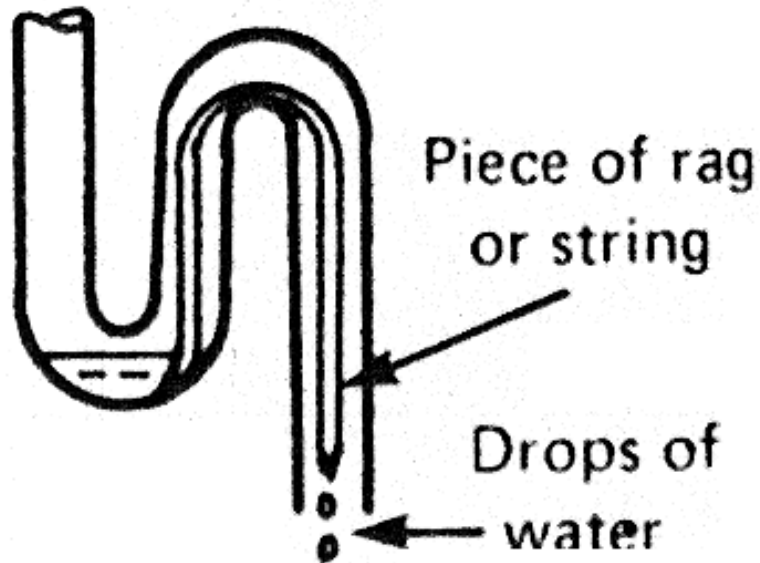

- A piece of rag or string caught on the outlet of the trap
- Additional maintenance should be carried out in high-risk locations

## Wavering out

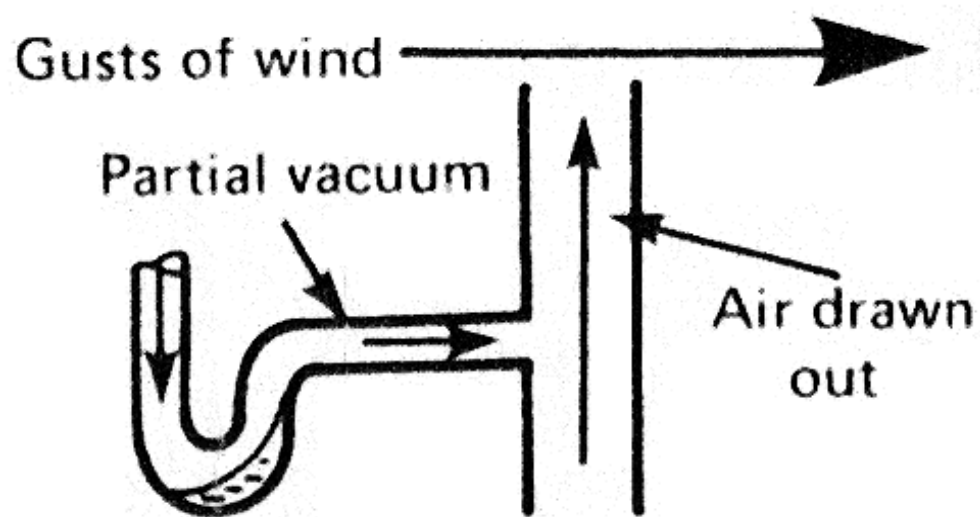

- Gusts of wind blowing across the top of a stack
- Site the vent terminal away from areas with troublesome effects

# Basic principles



- Loss of water seal (cont'd)
  - Evaporation:
    - About 2.5 mm of seal loss per week while appliances are unused
  - Bends and offsets:
    - Sharp bends in a stack → partial or complete filling of the pipe → large pressure fluctuations
    - Foaming of detergents through highly turbulent fluid flow increases pressure fluctuations
    - A bend of minimum radius 200 mm at the base of a soil stack

# Basic principles



- Loss of water seal (cont'd)
  - Surcharging:
    - An underground drain that is allowed to run full causes large pressure fluctuations
    - Solution: additional stack ventilation
  - Intercepting traps:
    - Where a single-stack system is connected into a drain with an interceptor trap nearby, fluid flow is restricted
    - Additional stack ventilated is used
  - Leakage:
    - Can occur through mechanical failure of joints or the use of a material not suited to the water conditions

**Sink or drain or bathtub or washer**  
Air enters drain with toilet flush

**Odor problem caused by missing vents**

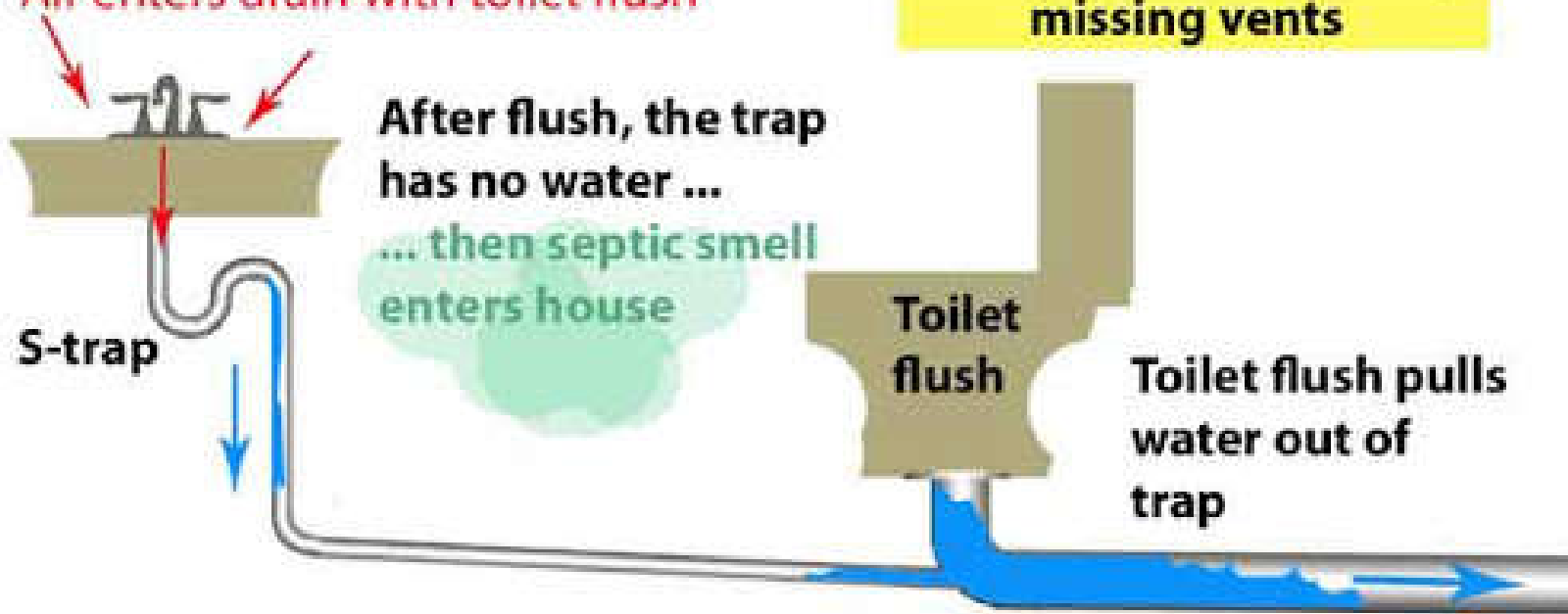

**Vents solve odor problem**

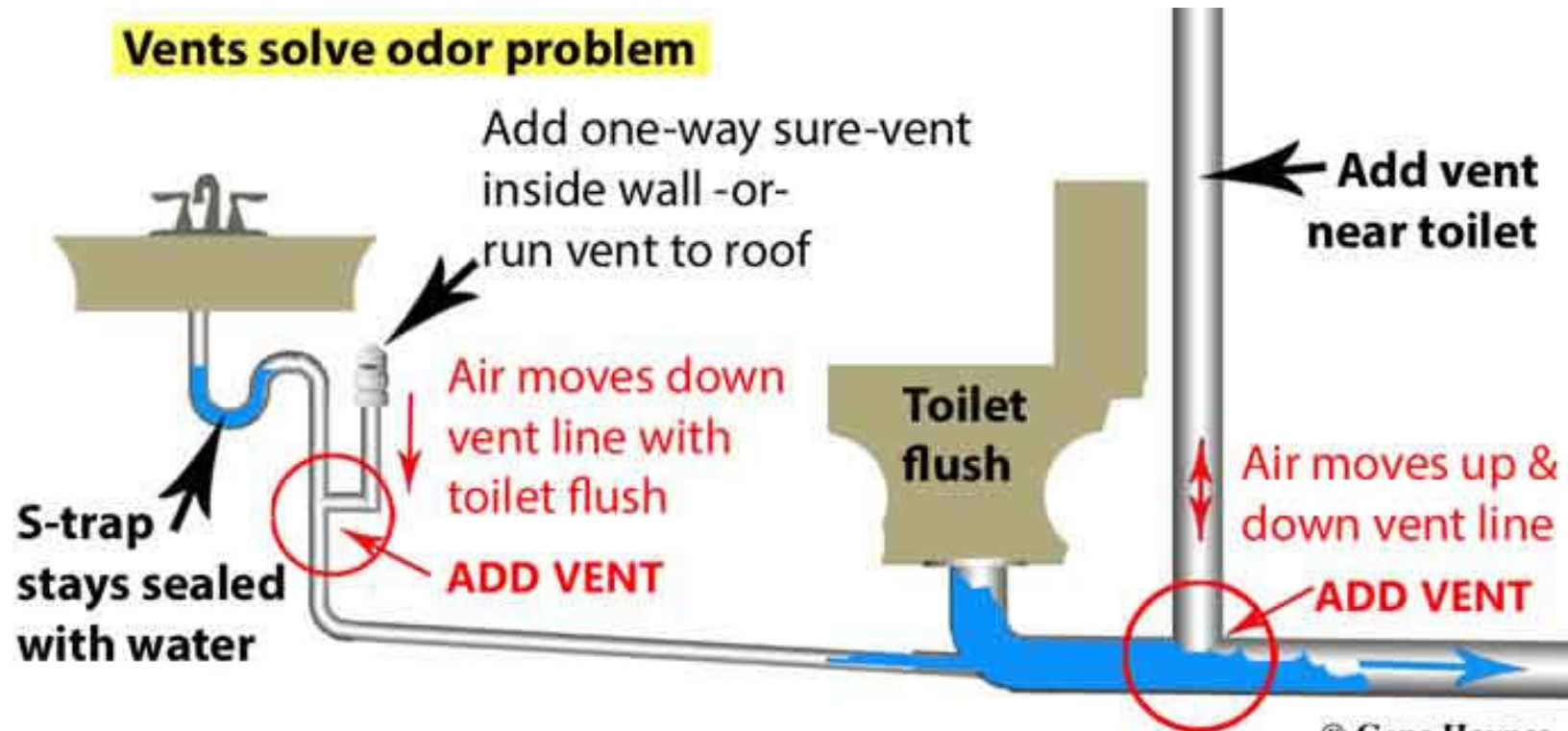

# Basic principles



- Maintain trap water seals by anti-siphon (反虹吸) pipes or using resealing or anti-siphon traps, such as
  - McAlpine trap
  - Grevak trap
  - Econa trap
  - Anti-siphon trap
- However, they may require more maintenance & are liable to be noisy

# Anti-siphonage pipes

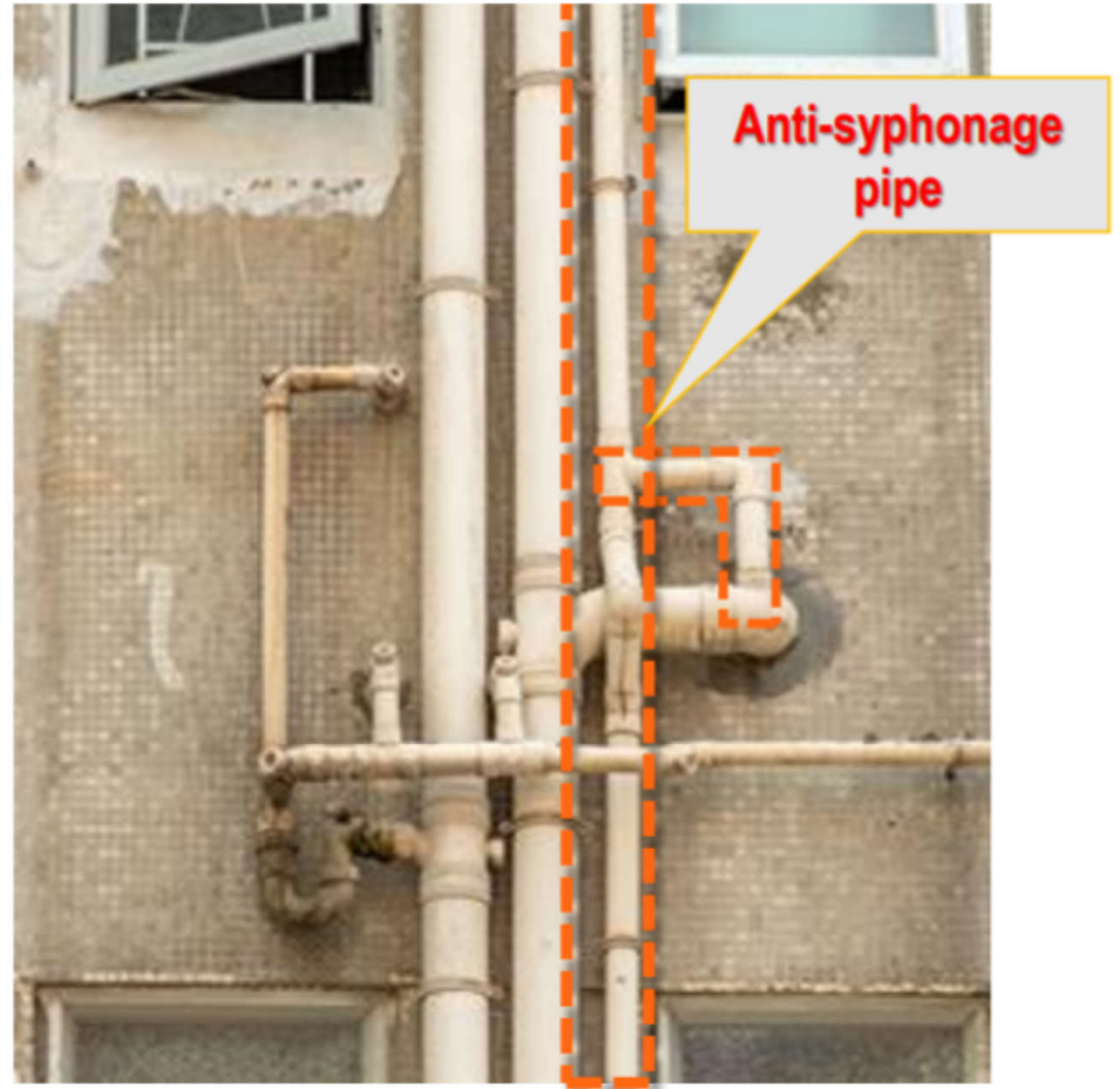

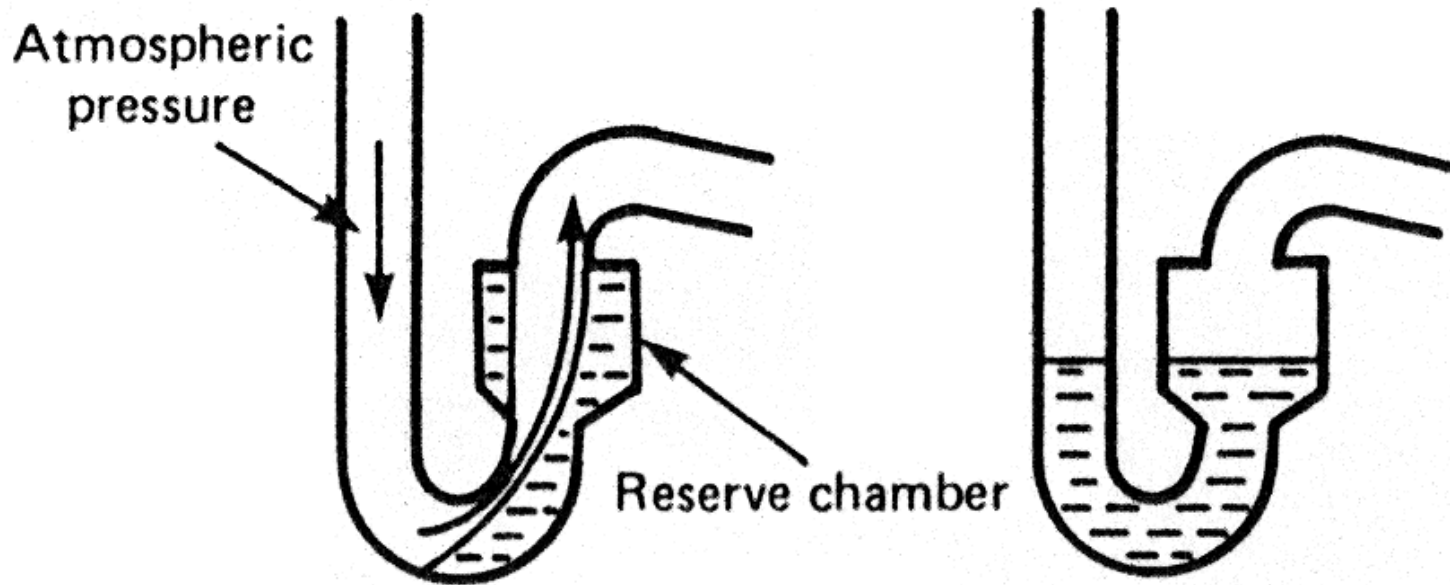

[McAlpine resealing trap](#)

(a) Siphonage

(b) Trap resealed

Air drawn through anti-siphon pipe

[Grevak resealing trap](#)

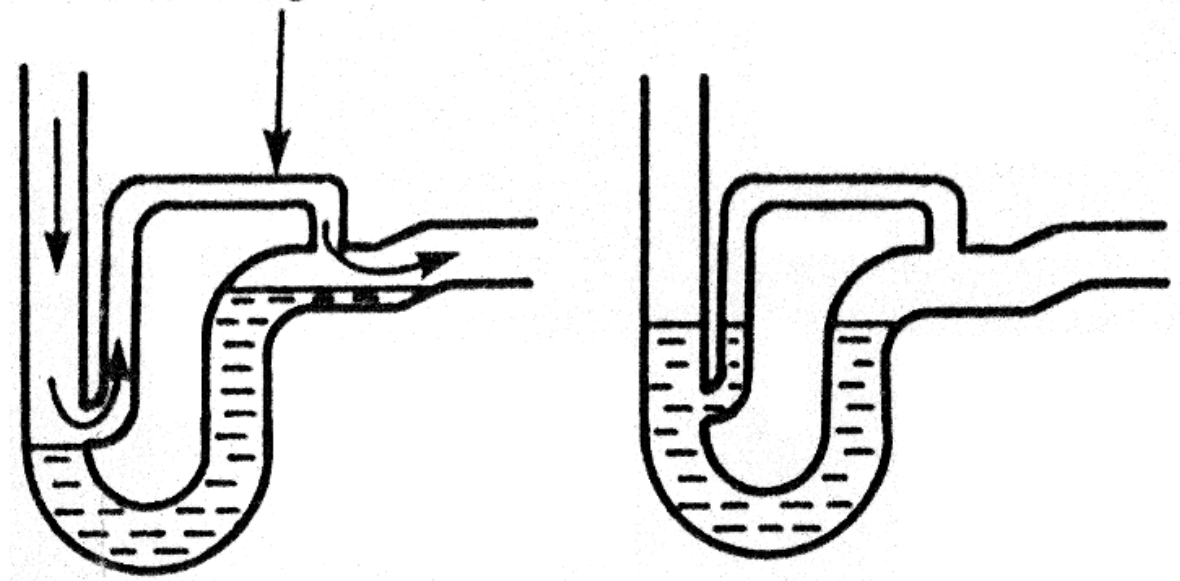

(a) Siphonage

(b) Trap resealed

(Source: Hall, F. and Greeno, R., 2008. *Building Services Handbook*)

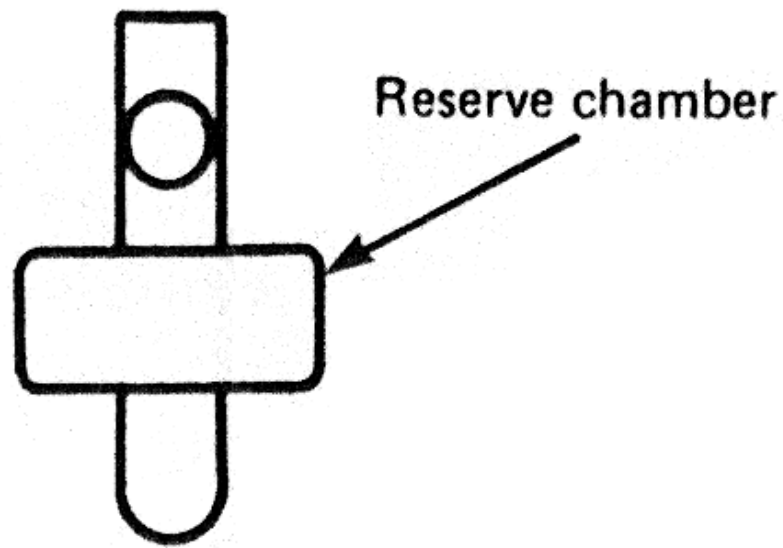
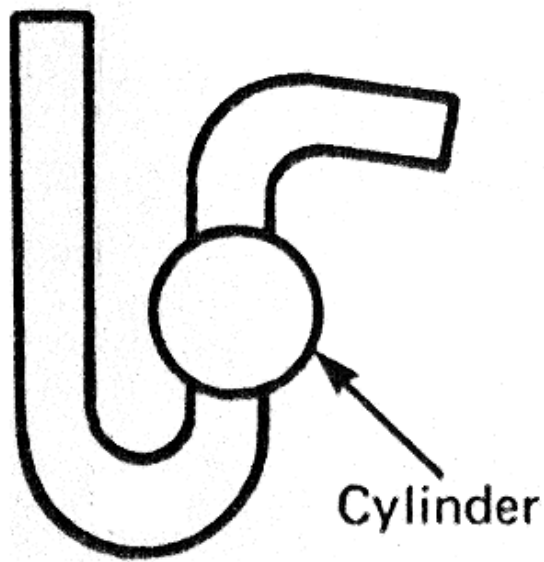

[Econa resealing trap](#)

[Anti-siphon trap](#)

**BOTTLE TRAP**

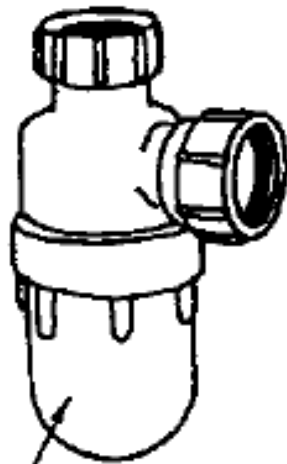

**Detachable bowl**

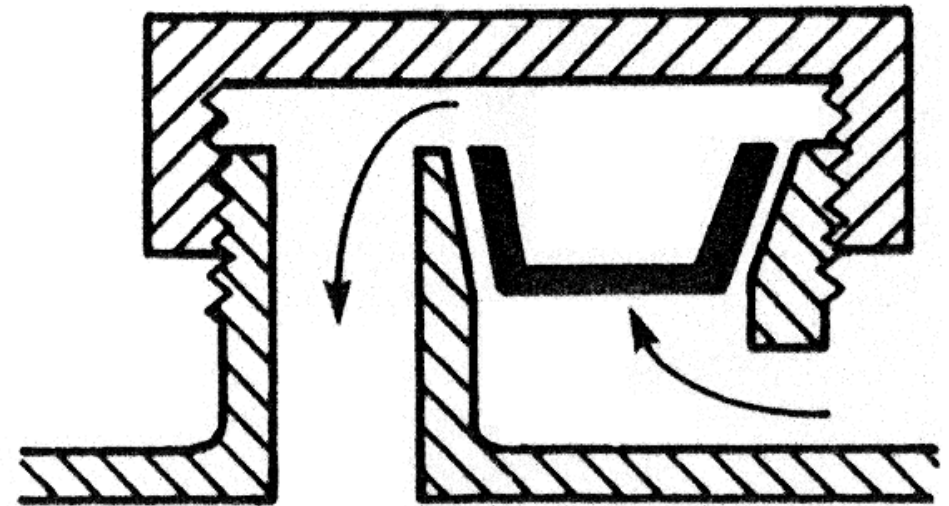
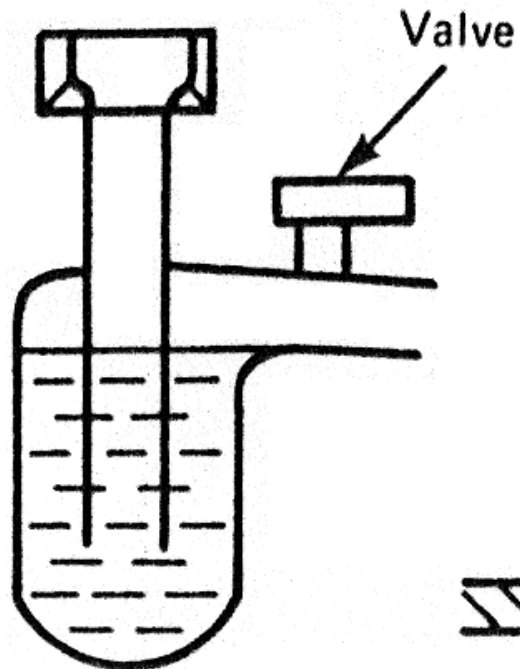

**Section of valve**



# U-shaped trap with anti-siphonage air valve

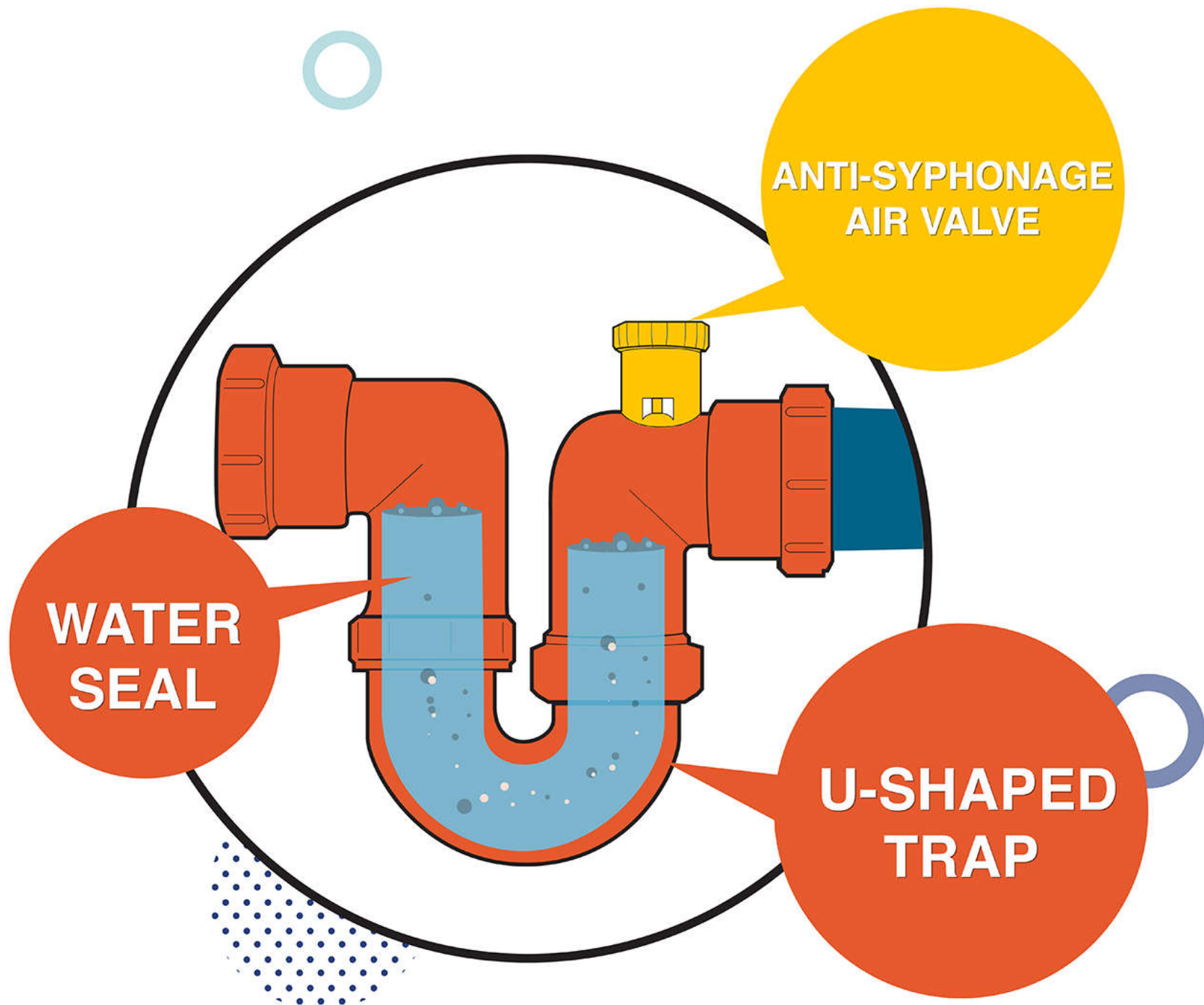

# Bottle trap with anti-siphonage air valve

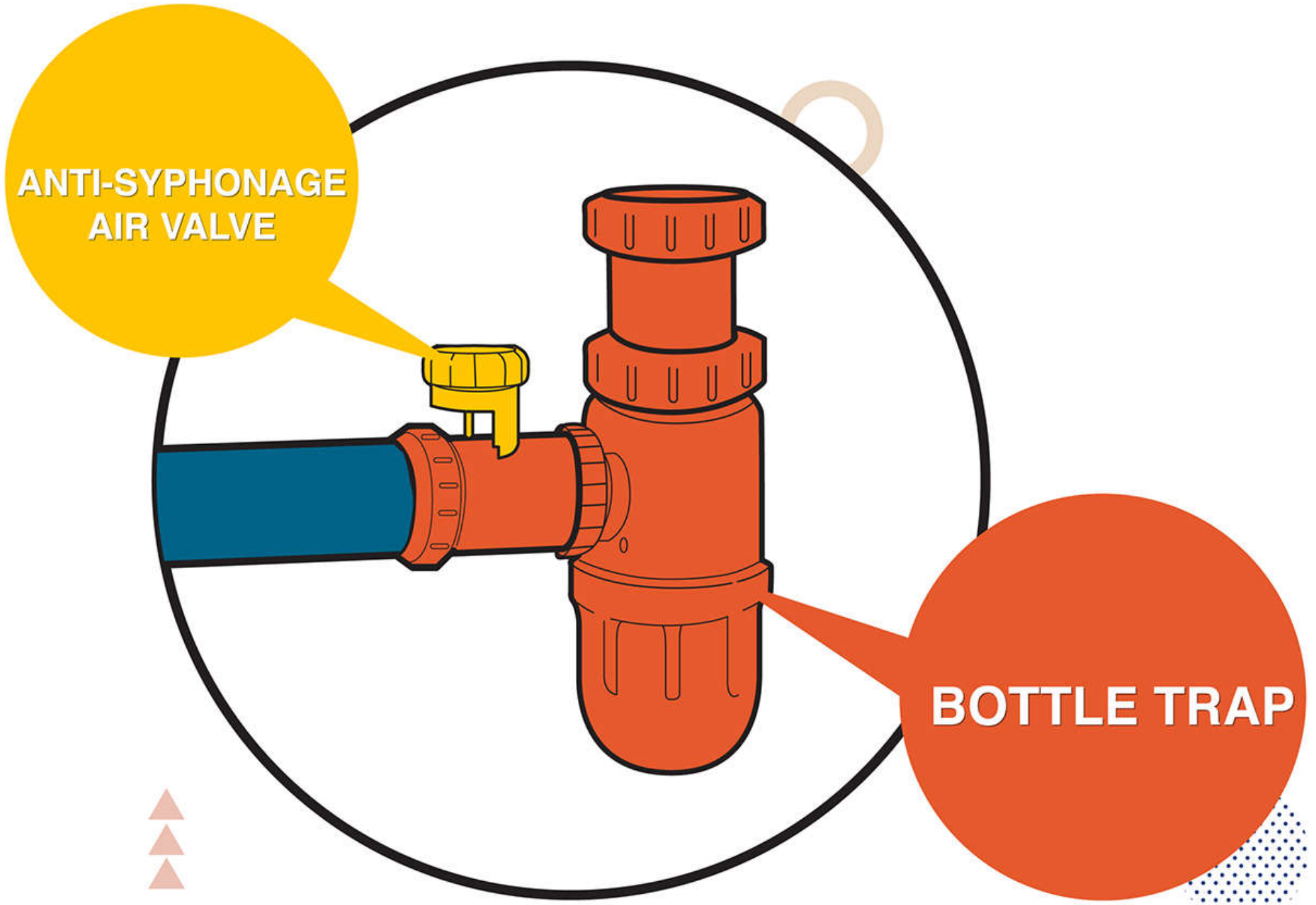

# Sanitary drainage



- Capacities of stacks
  - Maximum stack capacity is normally limited to about one quarter ( $1/4$ ) full bore
    - To allow space for a core of air in centre of the stack
    - The air keeps pressure fluctuations to a minimum
  - [New] Discharge unit (DU) method (see tables)
    - Add up all the DUs (l/s) applicable to a discharge stack
    - Not all fittings will be in simultaneous use
    - The peak design flow is assessed by applying a frequency of use K factor to the sum of DUs
    - Must also add any other continuous or fixed flow

## Discharge unit (DU) for common appliances & K factor

Appliance	DU (l/s)*
Wash basin or bidet	0.3
Shower without plug	0.4
Shower with plug	1.3
Single urinal with cistern	0.4
Slab urinal (per person)	0.2
Bath	1.3
Kitchen sink	1.3
Dishwasher (household)	0.2
Washing machine (6 kg)	0.6
Washing machine (12 kg)	1.2
WC with 6 litre cistern	1.2 – 1.7
WC with 7.5 litre cistern	1.4 – 1.8
WC with 9 litre cistern	1.6 – 2.0

\* For a single stack system with full bore branch discharge pipes

(Source: IOP, 2002. *Plumbing Engineering Services Design Guide*)

Usage of appliance	K
Intermittent use, e.g. dwelling, guesthouse, office	0.5
Frequent use, e.g. hotel, restaurant, school, hospital	0.7
Congested use, e.g. toilets and/or showers open to the public	1.0
Special use, e.g. laboratory	1.2

$$Q_{ww} = K \sqrt{\Sigma DU}$$

where

$Q_{ww}$  = wastewater flow rate (l/s)

K = frequency of use

$\Sigma DU$  = sum of DUs

$$Q_{tot} = Q_{ww} + Q_c + Q_p$$

$Q_{tot}$ : total flowrate (l/s)

$Q_c$ : continuous flowrate (l/s)

$Q_p$ : pumped flowrate (l/s)

## Maximum capacity of primary ventilated discharge stacks

Min. stack & vent internal diameter	litre/sec
75 mm*	2.6
100 mm	5.2
150 mm	12.4

## Maximum capacity of secondary ventilated discharge stacks

Usage of appliance		litre/sec
Stack & vent	Vent	
75 mm*	50 mm	3.4
100 mm	50 mm	7.3
150 mm	50 mm	18.3

\* No WC's allowed on 75 mm stacks.

Once the  $Q_{tot}$  value has been obtained, a decision about the stack size, and ventilation principle can be made by referring to the above Tables.

**Example 1:** Determine total design flowrate and stack requirements for an 11-storey block of apartments. The stack will serve one apartment per floor, comprising of bathroom, en-suite shower room and fully fitted kitchen.

Answer:-

DU per flat:

2 WC's x 1.7	= 3.4
2 wash basins x 0.3	= 0.6
1 bath	= 1.3
1 shower	= 0.4
1 kitchen sink	= 1.3
1 washing machine	= 0.6
1 dishwasher	= 0.2
	-----
Total DUs	= <b>7.8</b>

Assume a primary ventilated stack is adequate, thus the bottom storey must connect separately to drain.

For 10 storeys,  $\Sigma\text{DU}: 7.8 \times 10 = 78$   
 $K = 0.5$ , so  $Q_{ww} = 0.5\sqrt{78} = 4.42 \text{ l/s}$   
 $Q_c \ \& \ Q_p = \text{zero}$ , so  $Q_{\text{tot}} = \underline{\underline{4.42 \text{ l/s}}}$

From table, a **100 mm** primary ventilated stack has a limit of 5.2 l/s, so this size is adequate. Secondary ventilation is not required.

**Example 2:** Determine total design flowrate and stack requirements for an 11-storey hotel. The stack will serve two en-suite bathrooms on each floor; there will be air conditioning units on the roof with a peak discharge of 0.2 l/s, and laundry equipment on the 5th floor with a peak discharge of 0.5 l/s.

Answer:-

DU per typical floor:

2 WC's x 1.7	= 3.4
2 wash basins x 0.3	= 0.6
2 baths x 1.3	= 2.6
	-----
Total DUs	= <b>6.6</b>

Assume a primary ventilated stack is adequate, thus the bottom storey must connect separately to drain.

For 10 storeys,  $\Sigma DU: 6.6 \times 10 = 66$   
 $K = 0.7$ , so  $Q_{ww} = 0.7\sqrt{66} = 5.7 \text{ l/s}$   
 $Q_{tot} = 5.7 + 0.2 + 0.5 = \underline{\underline{6.4 \text{ l/s}}}$

There are two options: a 150 mm primary ventilated stack, or a 100 mm secondary ventilated stack and 50 mm secondary vent. Practical considerations would dictate the best choice, for example, a proprietary fitting such as the collar boss is only available in the 100 mm size.

# Sanitary drainage



- Normal practice for branch pipes
  - Soil & vent stack or branch with at least one WC: at least 100 mm diameter
  - Outlets from wash basins: a 32 mm minimum diameter
  - Sinks and baths discharge pipes: a 40 mm minimum diameter

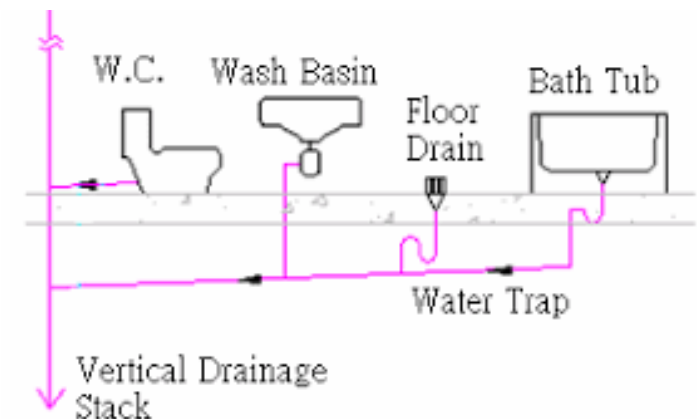



## Materials for sanitary pipework

Material	Application	Jointing
Cast iron	50 mm and above vent and discharge stacks	50 mm and above vent and discharge stacks
Galvanised steel	Waste pipe	Screwed
Copper	Waste pipes and traps	Compression, capillary, silver solder, bronze weld or push-fit rings seal
Lead	Waste pipes and discharge stacks	Soldered or lead welded
ABS (acrylonitrile butadiene styrene)	Up to 50 mm waste and vent pipes	Solvent cement and push-fit ring seal
High-density polyethylene	Up to 50 mm waste and ventilating pipes and traps	Push-fit ring seal and compression fittings
Polypropylene	Up to 50 mm waste and ventilating pipes and traps	Push-fit ring seal and compression couplings
Modified PVC	Up to 50 mm waste and vent pipes	Solvent cement and push-fit ring seal
Unplasticized PVC	Over 50 mm soil and vent stacks; vent pipes under 50 mm	Solvent cement and push-fit ring seal
Pitch fibre	Over 50 mm discharge and vent stacks	Driven taper or polypropylene fitting with a push-fit ring seal

# Sanitary drainage



- Drainage for basement

- The manhole discharging to outside locates at G/F
- Water from basement floors (some at even basement 3, about 10 meters below ground floor).  
How to discharge it?

- By a sump pit and pumps installed at the lowest floor
- Note the need of standby pump
- Pump on/off control by level switch

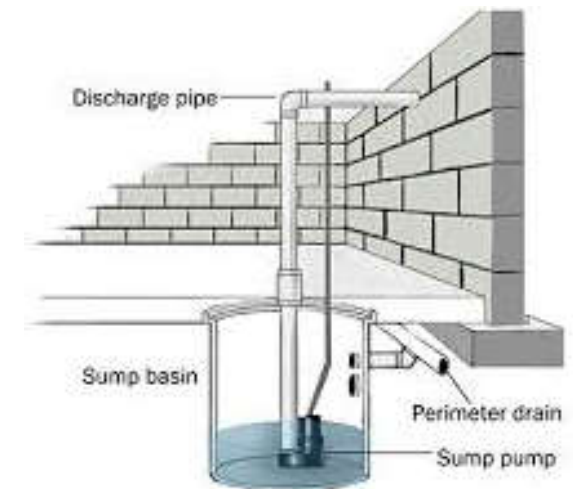

# Sanitary drainage



- Drainage for grease/oil generating area, such as carparks and kitchens
- Grease and oil cause problems to the sewer by accumulating on the inside of sewer pipes
  - Reduce capacity of sewer pipes and cause sewage overflows, offensive odour and an unhealthy environment
  - The cleaning of grease deposits from sewers is difficult and can be dangerous and costly

# Sanitary drainage



- A petrol interceptor & grease trap are devices used for removing oil and grease from wastewaters
- Petrol interceptor
  - Water from carpark may contain oil (petrol)
  - Water from carpark could not be directly discharged to public sewer
  - Water must pass a petrol interceptor before discharging out

# Sanitary drainage



- Grease trap

- Kitchen from food courts and restaurants contains large quantity of grease that is not permitted to be discharged out to the public sewer
- Water must pass through a grease trap before discharging out
- Food license needed before food court and restaurant starting business
- Provision of grease trap is a licensing requirement

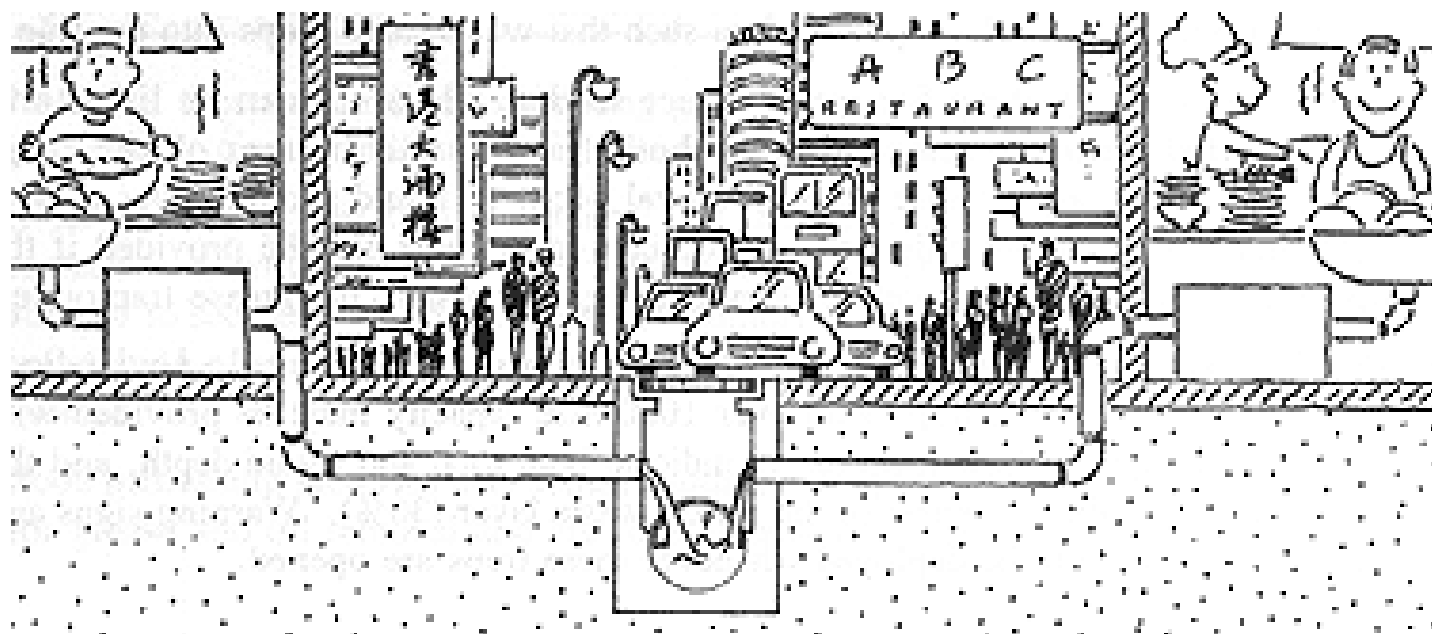

隔油池頂部外視圖(尺寸均以毫米為單位)

EXTERNAL TOP VIEW OF GREASE TRAP (all dimensions in mm)

Grease trap  
typical design

CLEAR OPENING FOR ACCESS

500X500 MIN. WITH  
LIGHT WEIGHT COVER

出入口輕便活動蓋板

最小尺寸 500×500 毫米

出水口

OUTLET

取樣口蓋板

200×200 毫米

COVER TO  
SAMPLING HOLE

200X200mm

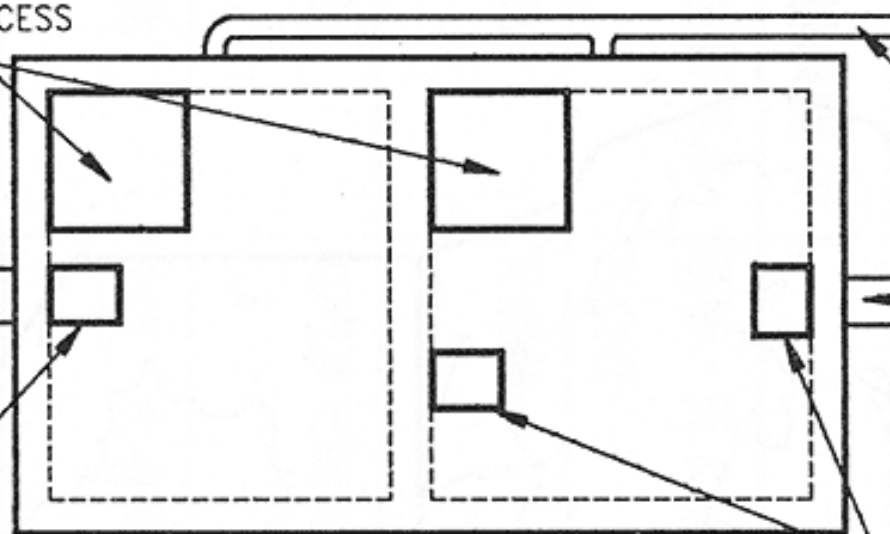

通風管

VENT PIPE

入水口

INLET

清理口蓋板

200×200 毫米

COVER TO  
CLEANING HOLES

200X200mm

混凝土隔油池頂視圖〔無蓋〕(尺寸均以毫米為單位)

TOP VIEW WITHOUT COVER, CONCRETE GREASE TRAP (all dimensions in mm)

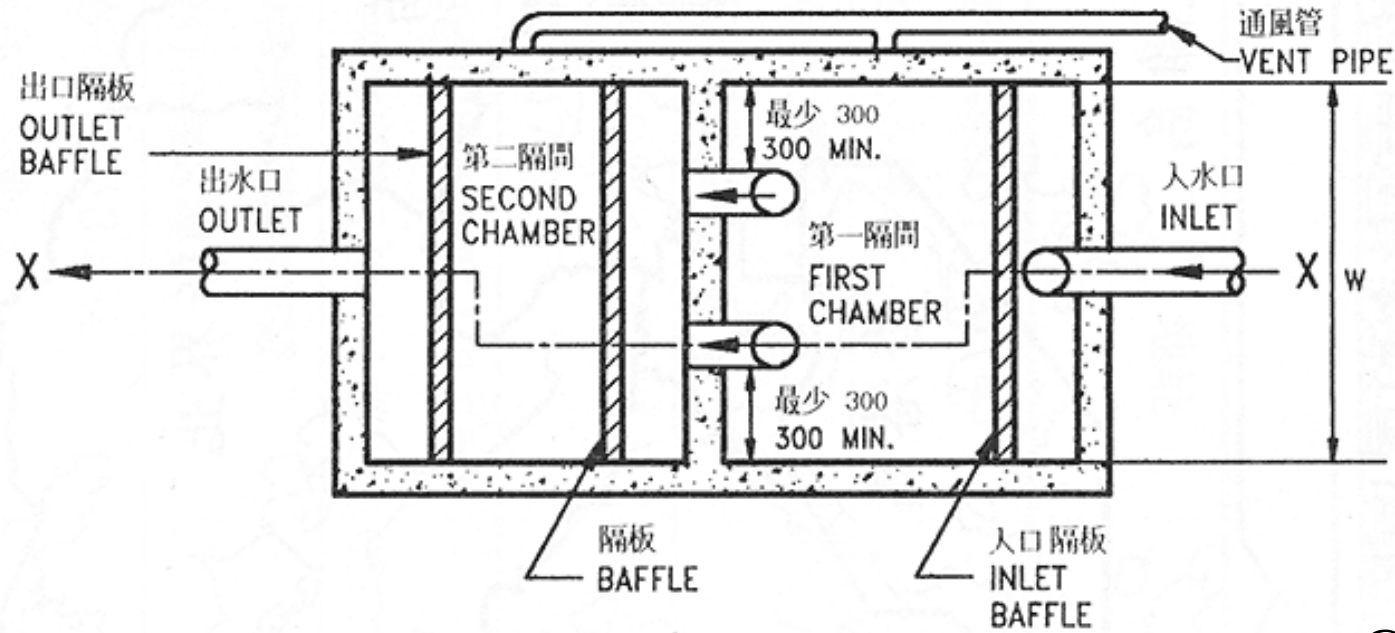

橫切面 X - X 側視圖 (尺寸均以毫米為單位)

SIDE VIEW THROUGH SECTION X-X (all dimensions in mm)

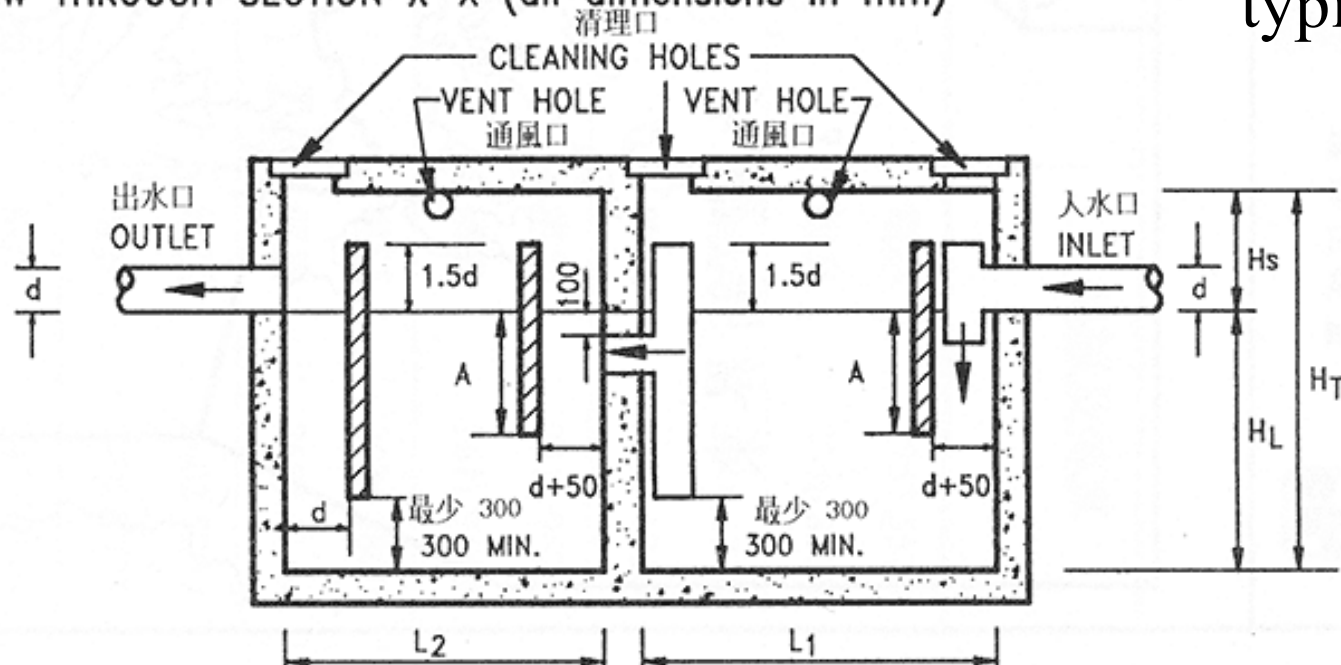

Grease trap  
typical design

## Grease trap capacity requirements in HK

Average hourly water use (litres)	Kitchen floor area (sq.m)	Minimum grease trap capacity (litres)	Example internal dimensions * (mm)		
			Length	Width	Total depth
0-125	---	250	1200	525	600
250	8	490	1450	700	725
500	16	790	1700	825	850
750	24	1,050	1800	875	1000
1000	32	1,220	1950	950	1000

\* The length and width dimensions do not include wall and cover thickness for concrete grease traps (typically 150 mm). For steel traps, wall thicknesses can be ignored.





# Stormwater drainage

- Stormwater or rainwater drainage systems
  - Design for roofs, walls and ground drainage
    - Include rain water outlets, gutters, rain water stacks and occasional require sum and pump system for disposal
    - Require integration with architect
- Rain water flow rate,  $Q$  (l/s)
  - $Q = C \times A \times I / 3600$ 
    - $C$  : impermeability factor or run-off coefficient
    - $A$  : drainage or catchment area (m<sup>2</sup>)
    - $I$  : rainfall intensity (mm/hr)

## Ground impermeability factor

<b>Nature of surface</b>	<b>Impermeability factor</b>
Road or pavement	0.90
Roof	0.95
Path	0.75
Parks or gardens	0.25
Woodland	0.20



# Stormwater drainage

- Drainage or catchment area,  $A$  ( $\text{m}^2$ )
  - It is the area that surface water will be collected and discharge to the drainage outlet
  - For catchment area with vertical wall exists, it shall include 50% of the vertical wall area:
    - $A = A_f + 0.5 A_w$
    - where  $A_f$  is the catchment floor area,  $A_w$  is the area of vertical wall
  - The surface area shall be laid in fall to the point of drain outlet of not less than 1:100 to facilitate effective water collection

# Example of flat-roof drainage

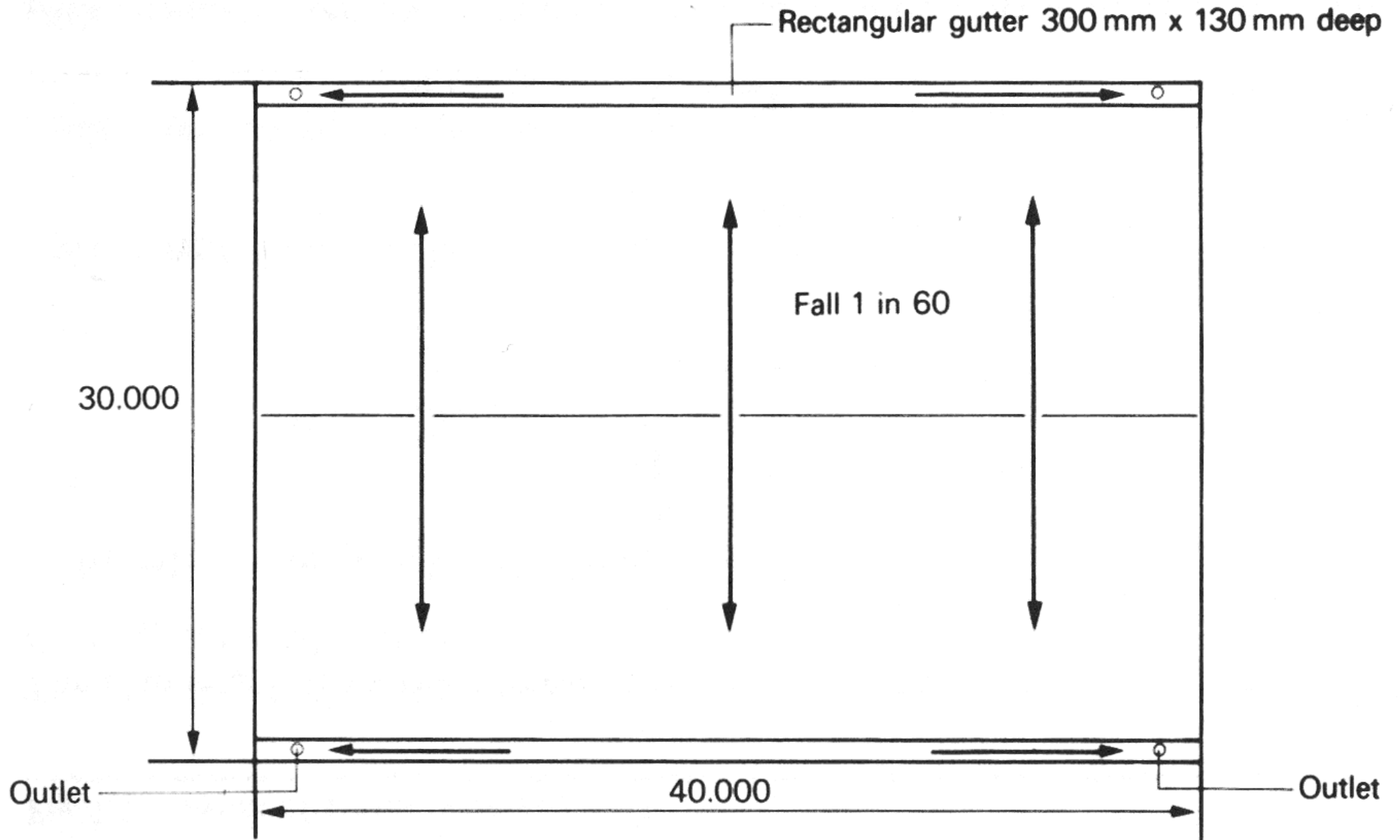



# Stormwater drainage

- Rainfall: Time of concentration,  $t_c$  (min)
  - The maximum time taken by surface water to travel from the catchment boundary to the point of drainage outlet. It can be estimated by:

$$t_c = 0.14465 \times \left( \frac{L}{H^{0.2} A^{0.1}} \right)$$

- $H$  is average fall (m per 100m) from the summit of catchment to the point of drainage outlet
- $L$  is the largest distance from catchment boundary to the point of drainage outlet (m)



# Stormwater drainage

---

- Select a suitable rainfall intensity based on:
  - Degree of acceptable risk to life and property
    - Use a larger value if overflow cannot be tolerated
  - Statutory requirements
  - Assessment of economic viability
- Average rainfall intensity
  - Determined by using the historical rainfall data of certain return period and duration
  - “Return period” = the period that the rainfall intensity will occur again (e.g. once every 20 years)



# Stormwater drainage

- Rainfall intensity,  $I$  (mm/hr) can be estimated by the following equation that is reasonable for a 20-years return period:
  - $I = 682 / (t_c + 4.5)^{0.44}$
- It is recommended to take minimum rainfall intensity as 200 mm/hr for design
  - See also rainfall data at Hong Kong Observatory's website ([www.hko.gov.hk/](http://www.hko.gov.hk/))

# Design storm profile statistics for HK

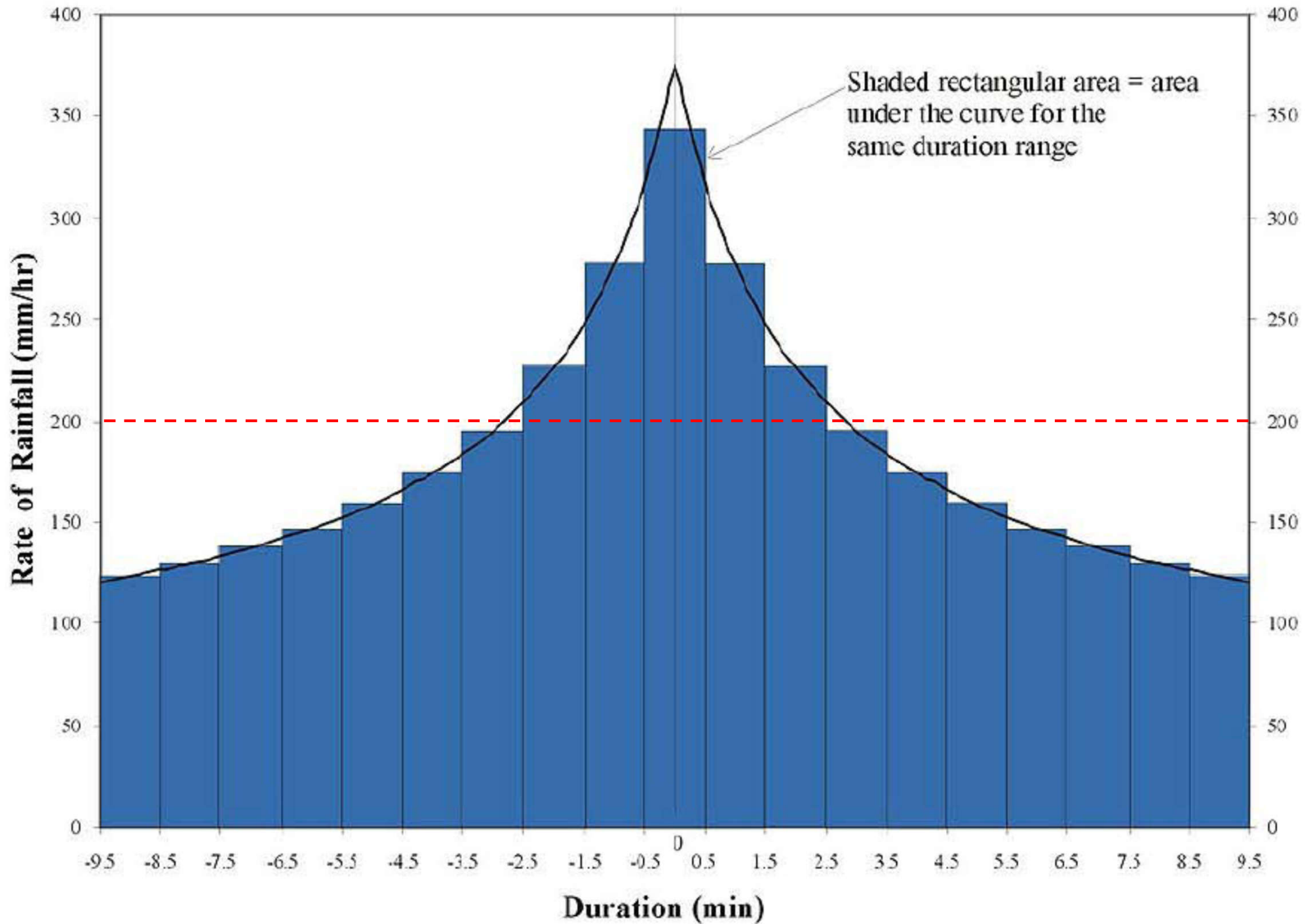





# Stormwater drainage

- Flow capacity of a level half-round gutter

- $Q = 2.67 \times 10^{-5} \times A_g^{1.25} \quad \text{l/s}$

- where  $A_g$  is cross-sectional area of the gutter (mm<sup>2</sup>)



- For level gutters other than half-round,

$$Q = \frac{9.67}{10^5} \times \sqrt{\frac{A_o^3}{W}}$$

- where  $A_o$  is the area of flow at the outlet (mm<sup>2</sup>);  
 $W$  is the width of the water surface (mm)



# Stormwater drainage

---

- Other influencing factors
  - Fall or slope of the roof
    - A fall of 1 in 600 increases flow capacity by 40%
  - Frictional resistance of a sloping gutter
    - May reduce water flow by 10%
    - Each bend can reduce this further by 25%
  - Water flow in downpipes
    - Much faster than in the gutter
    - Will never flow full!
    - Their diameter is usually taken as 66% of gutter width

# Typical flow capacities of a PVC half-round gutter at a 1 in 600 fall

<b>Nominal gutter width (mm)</b>	<b><math>Q</math> (l/s)</b>	
	<b>End outlet</b>	<b>Centre outlet</b>
75	0.46	0.76
100	1.07	2.10
125	1.58	2.95
150	3.32	6.64



# Stormwater drainage

---

- Sizing vertical stacks
  - In HK, under Building Ordinance (Cap. 123), every 700 mm<sup>2</sup> of pipe cross-section area shall be provided for 10 m<sup>2</sup> of horizontal roof area
  - Also, diameter of rainwater pipe shall be 65 mm minimum
- Hydraulic design may be used to size the vertical and horizontal pipes
  - The static head should cater for the velocity head and pipe friction



# Stormwater drainage

- Examples of drainage formula

- Chezy formula:  $V = C\sqrt{m \times i}$
- Crimp and Bruges formula:  $V = 84 \times m^{2/3} \times i^{1/2}$
- Vertical stack at quarter full:  $q = K \times d^{8/3}$

- More complicated one

- Colebrook-White equation:

$$V = -2 \times \sqrt{2g \times i \times D} \times \log \left[ \frac{K}{3.7D} + \frac{2.51\nu}{D \times \sqrt{2g \times i \times D}} \right]$$



# Stormwater drainage

- Velocities of flow

- Normally, 0.75 m/s is the accepted minimum to achieve self-cleansing
- An upper limit is required to prevent separation of liquid from solids
  - Such as 1.8 m/s for both surface & foul water drainage
  - Figures up to 3 m/s can be used if grit is present
- The flow velocity will have a direct impact on drain gradient



# Stormwater drainage

- Hydraulic mean depth (HMD)
  - Also known as hydraulic radius, represents the proportion or depth of flow in a drain
  - Calculated by dividing the area of water flowing in a drain by the contact or wetted perimeter
  - Drains are usually at maximum 0.75 full bore
  - Half full bore (0.5) is a more conservative design, allowing ample space for future connection & extension to the system

## Hydraulic mean depth (HMD) for half full bore

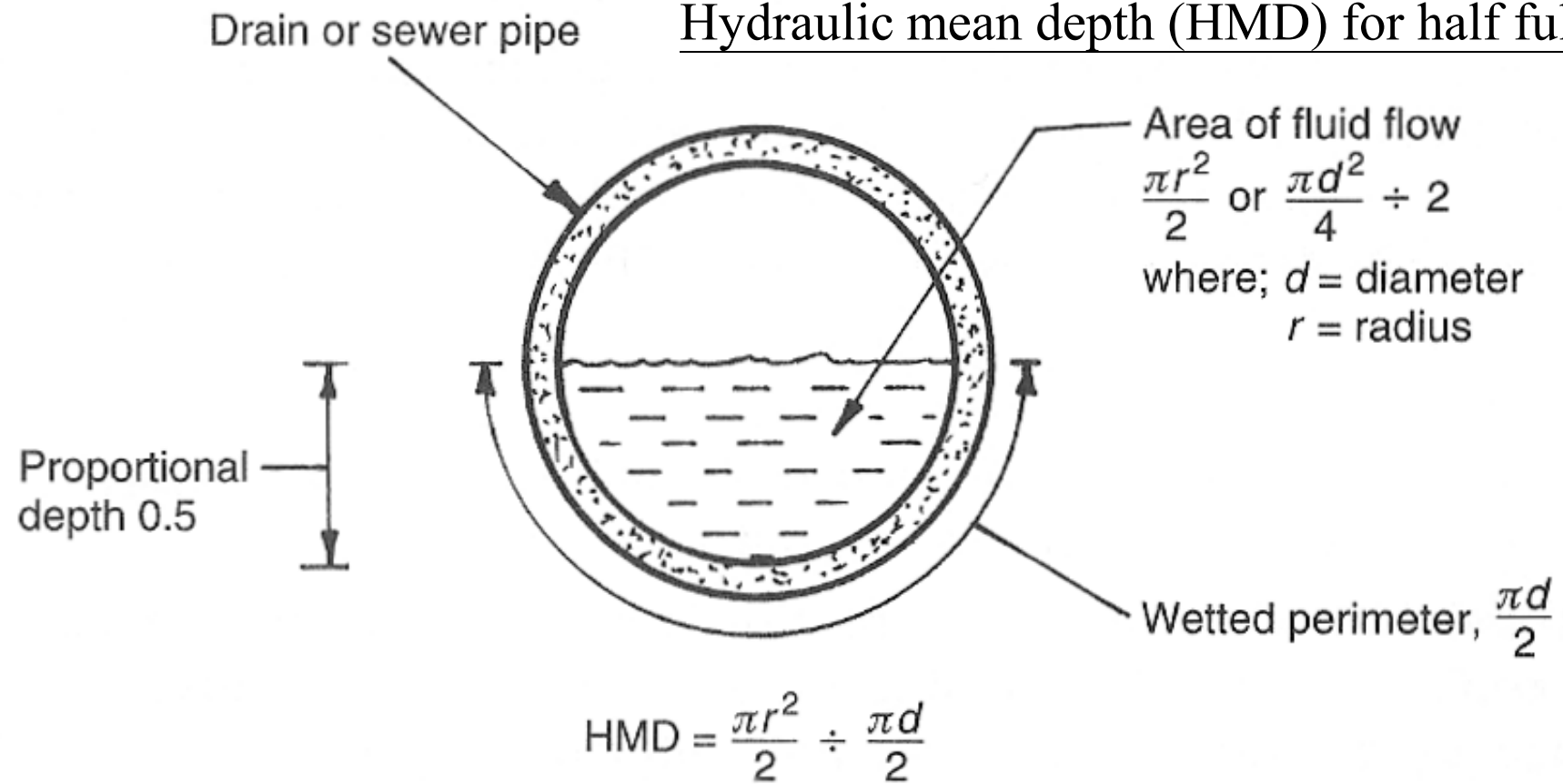

Depth of flow	HMD
0.25	Pipe dia. (m) / 6.67
0.33	Pipe dia. (m) / 5.26
0.50	Pipe dia. (m) / 4.00
0.66	Pipe dia. (m) / 3.45
0.75	Pipe dia. (m) / 3.33
Full	Pipe dia. (m) / 4.00



## Drainage design formulae:-

Chezy's formula:  $V = C\sqrt{m \times i}$

where  $V$  = velocity of flow (min. 0.75 m/s)

$C$  = Chezy coefficient

$m$  = hydraulic mean depth (HMD)

$i$  = inclination or gradient as 1/X

Manning's formula:  $C = \frac{m^{1/6}}{n}$

where  $C$  = Chezy coefficient

$n$  = coefficient of pipe roughness (0.010 for uPVC and clay drainware; 0.015 for cast concrete)

$m$  = hydraulic mean depth (HMD)

**Example:-** A 300 mm (0.3 m) nominal bore drain pipe flowing 0.5 proportional depth (half full bore). The Chezy coefficient can be calculated from Manning's formula:

$$\text{HMD} = 0.3 / 4 = 0.075$$

$$C = (0.075)^{1/6} / (0.010) = 65$$

Using a velocity of flow of 1.4 m/s, the minimum gradient can be calculated from Chezy's formula:

$$V = C \sqrt{m \times i}$$

$$1.4 = 65 \times \sqrt{(0.075 \times i)}$$

Thus,  $i = (1.4/65)^2 / 0.075 = 0.00617$  **or 1 in 162**

# Important issues



- Overcome access difficulties & facilitate future maintenance of common drain pipes
  - Locate & run underground drains in common parts of the building
  - Locate common soil & waste stacks in common parts
  - Pipe ducts shall be accessible from common parts
  - Unobstructed working space for maintenance & repair of the pipework
  - Accessible pipe wells for inspection & maintenance
  - Adequate access & facilities for maintenance of external building drainage pipes

# Importance of access for inspection, maintenance & repair of drain pipes

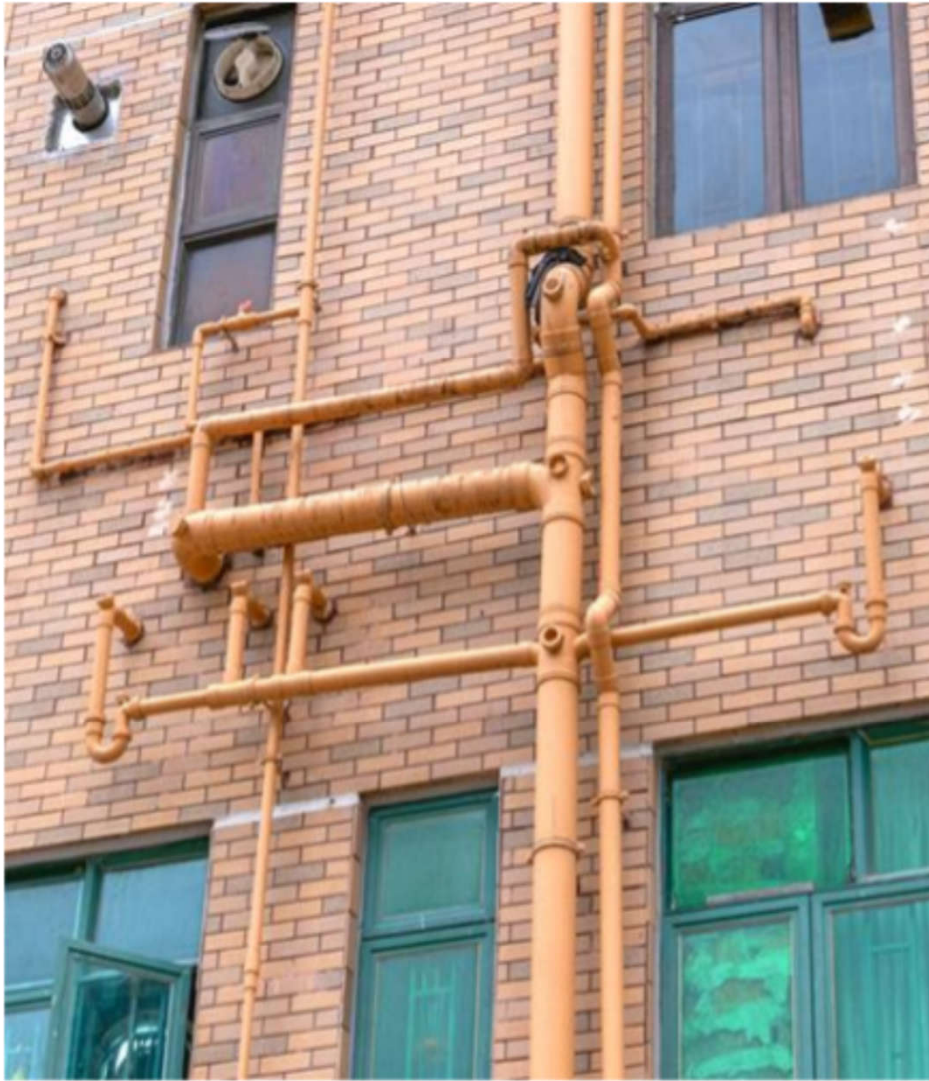

External wall of the building



Internal pipe duct accessible from common parts

# Diagrammatic section of a pipe well

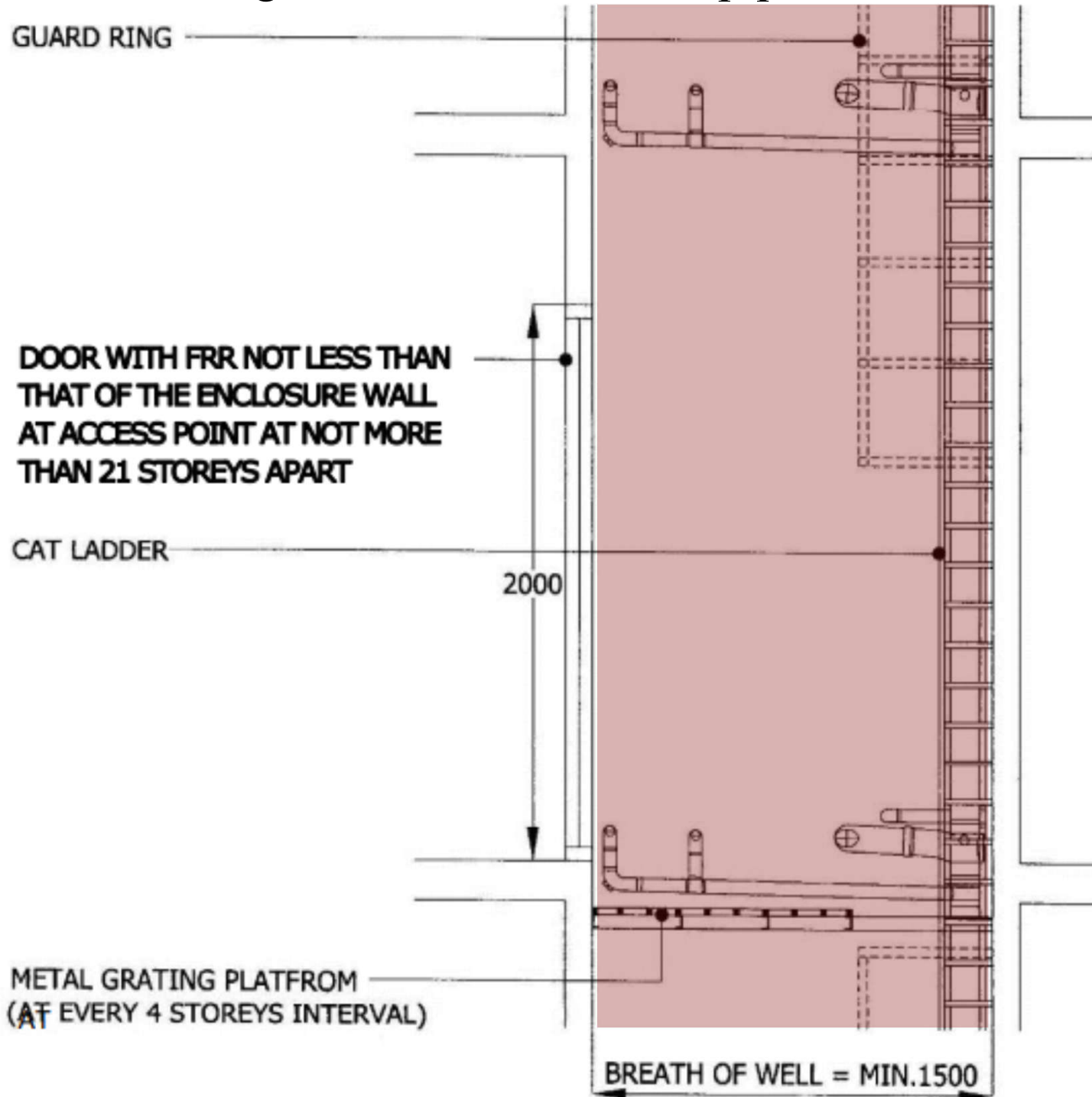

# Sample arrangement of a pipe well

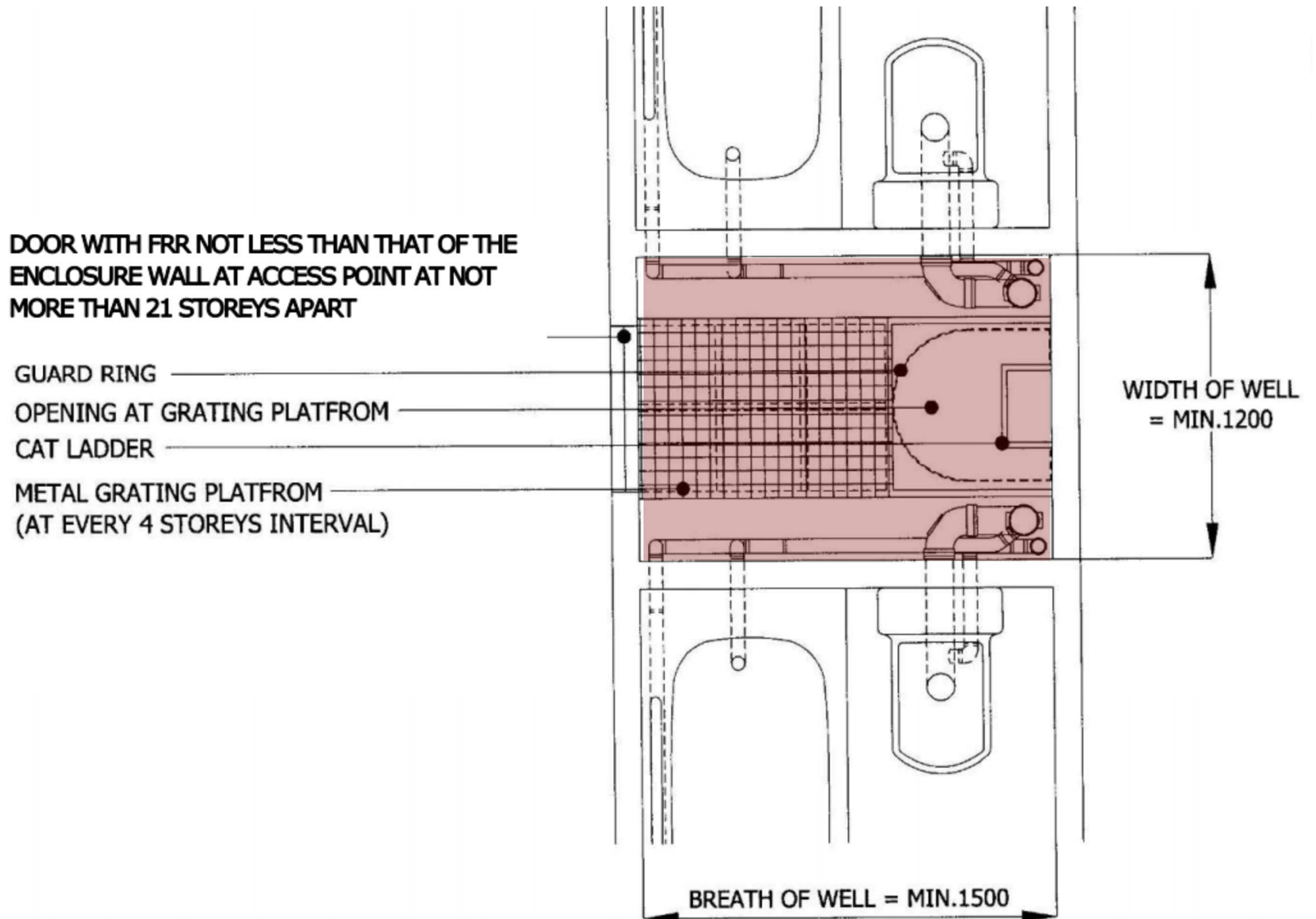

# Important issues



- Virus transmission through drainage pipes & light/pipe wells
  - COVID-19 transmission through air (cases in residential buildings in HK & other places)
  - Chimney/stack effect (buoyancy) 煙囪效應
    - Vertical transmission paths & aerosols (氣溶膠)
  - Virus could transmit through the floor drain & water closet
    - The SARS incident in 2003
    - Loss of water seal allows entry of odour/aerosols

# COVID-19 transmission through air in the drainage pipes

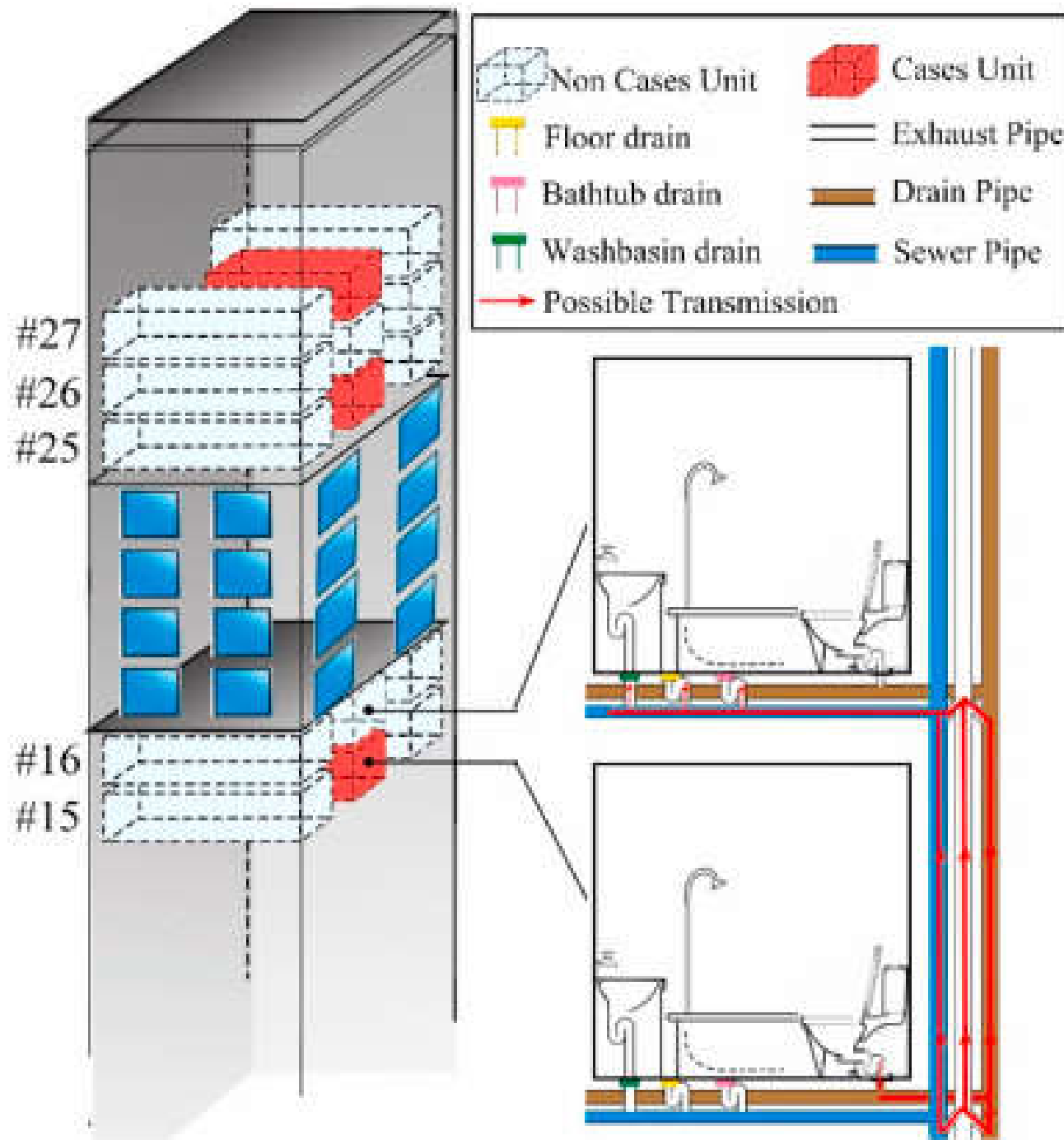

(Source: Lin G., *et al.*, 2021. Community evidence of severe acute respiratory syndrome coronavirus 2 (SARS-CoV-2) transmission through air, *Atmospheric Environment*, 246: 118083. <https://doi.org/10.1016/j.atmosenv.2020.118083>)



# Fecal aerosol transmission of COVID-19 (SARS-CoV-2) in a high-rise building

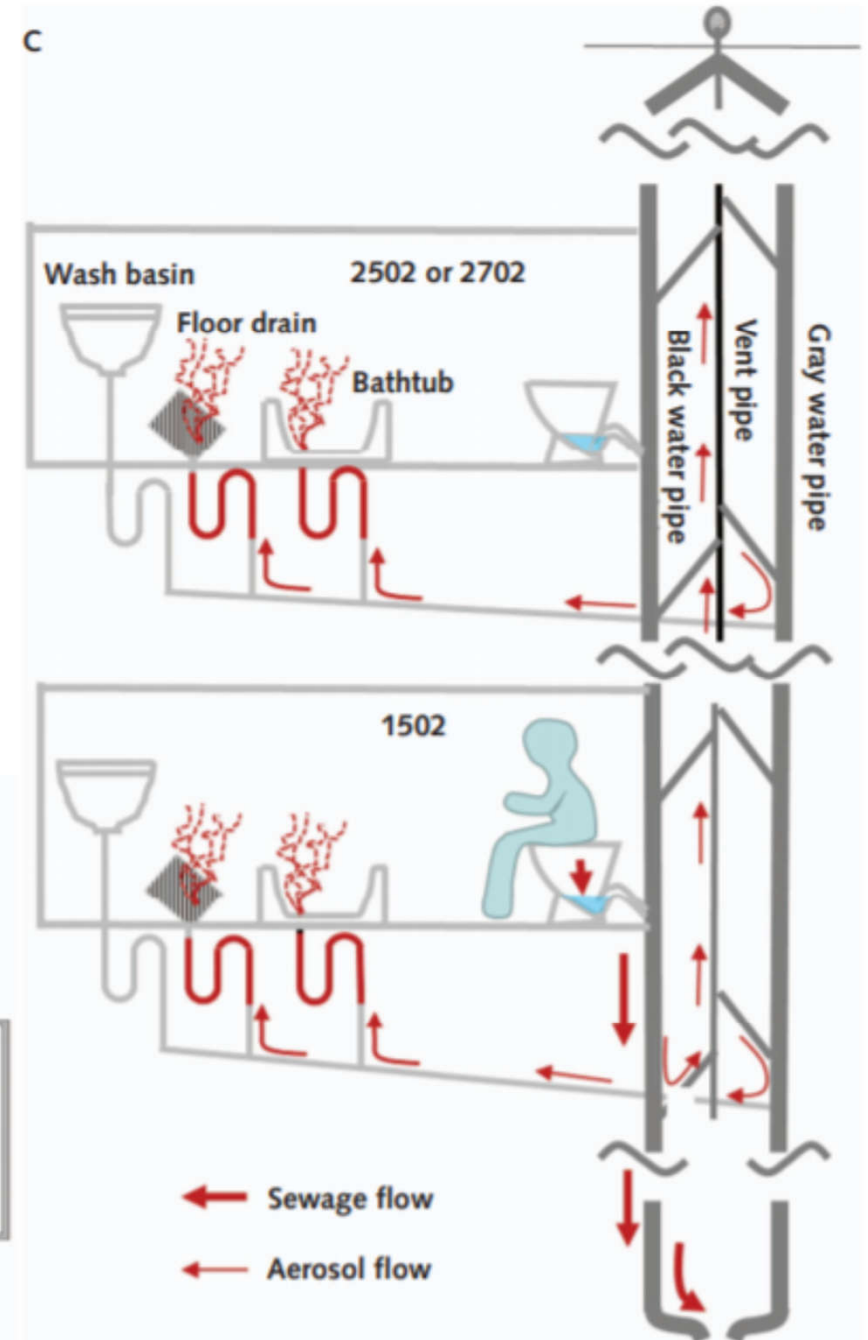
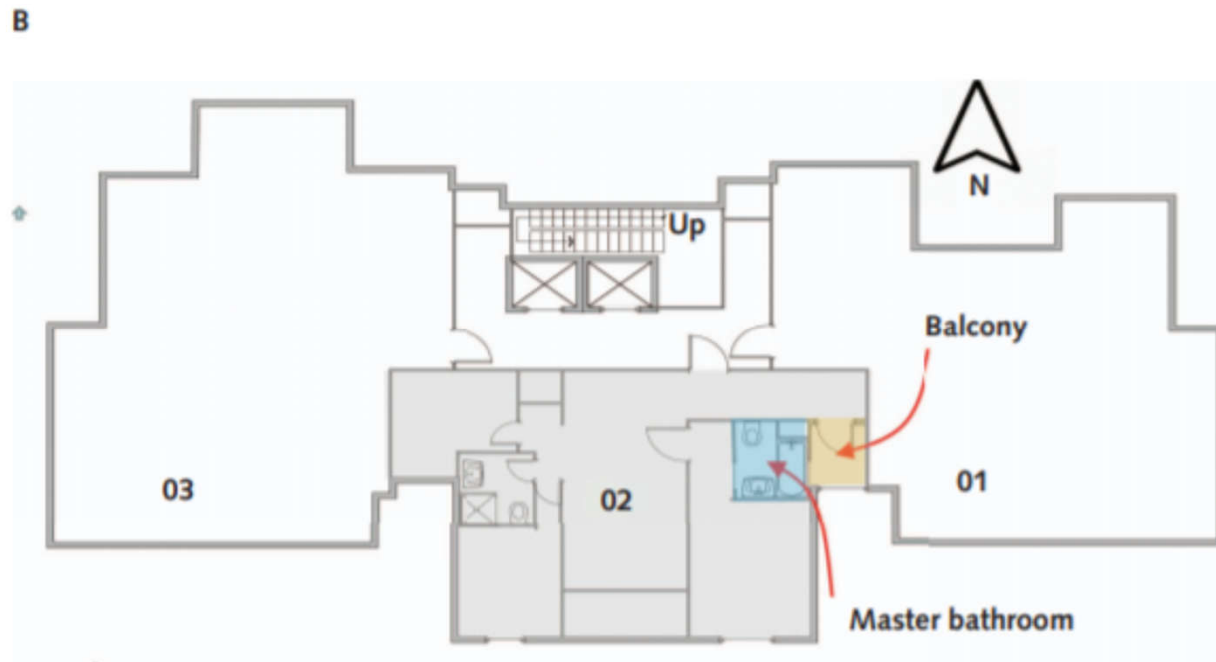
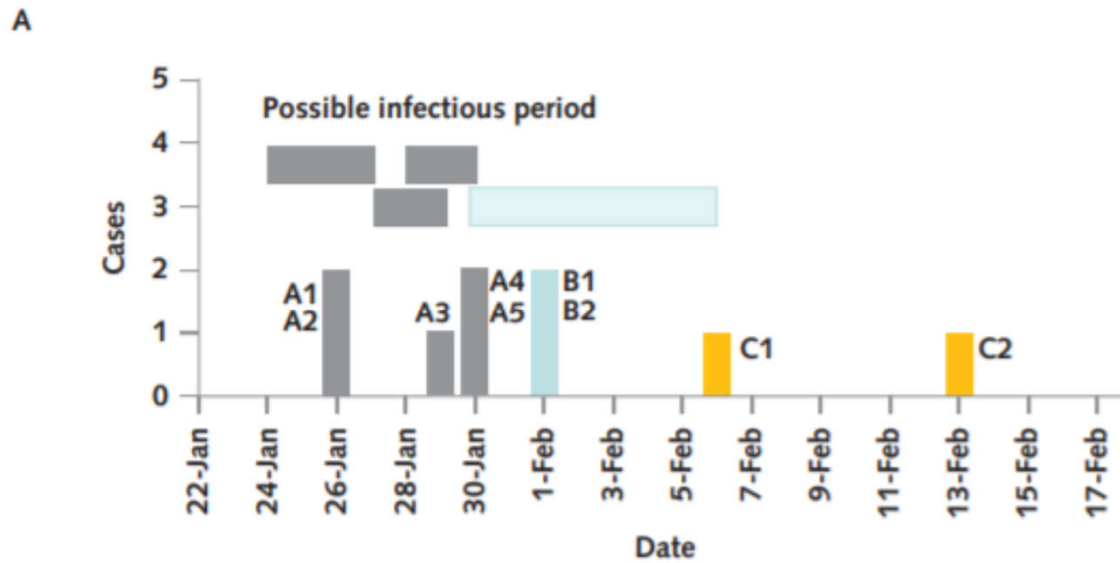

(Source: Kang M., *et al.*, 2020. Probable evidence of fecal aerosol transmission of SARS-CoV-2 in a high-rise building, *Annals of Internal Medicine*, 173: 974-80. [doi:10.7326/M20-0928] <https://pubmed.ncbi.nlm.nih.gov/32870707/>)

# Probable evidence of fecal aerosol transmission of SARS-CoV-2 in a high-rise building 高層建築中SARS-CoV-2的糞便氣溶膠傳播的可能證據

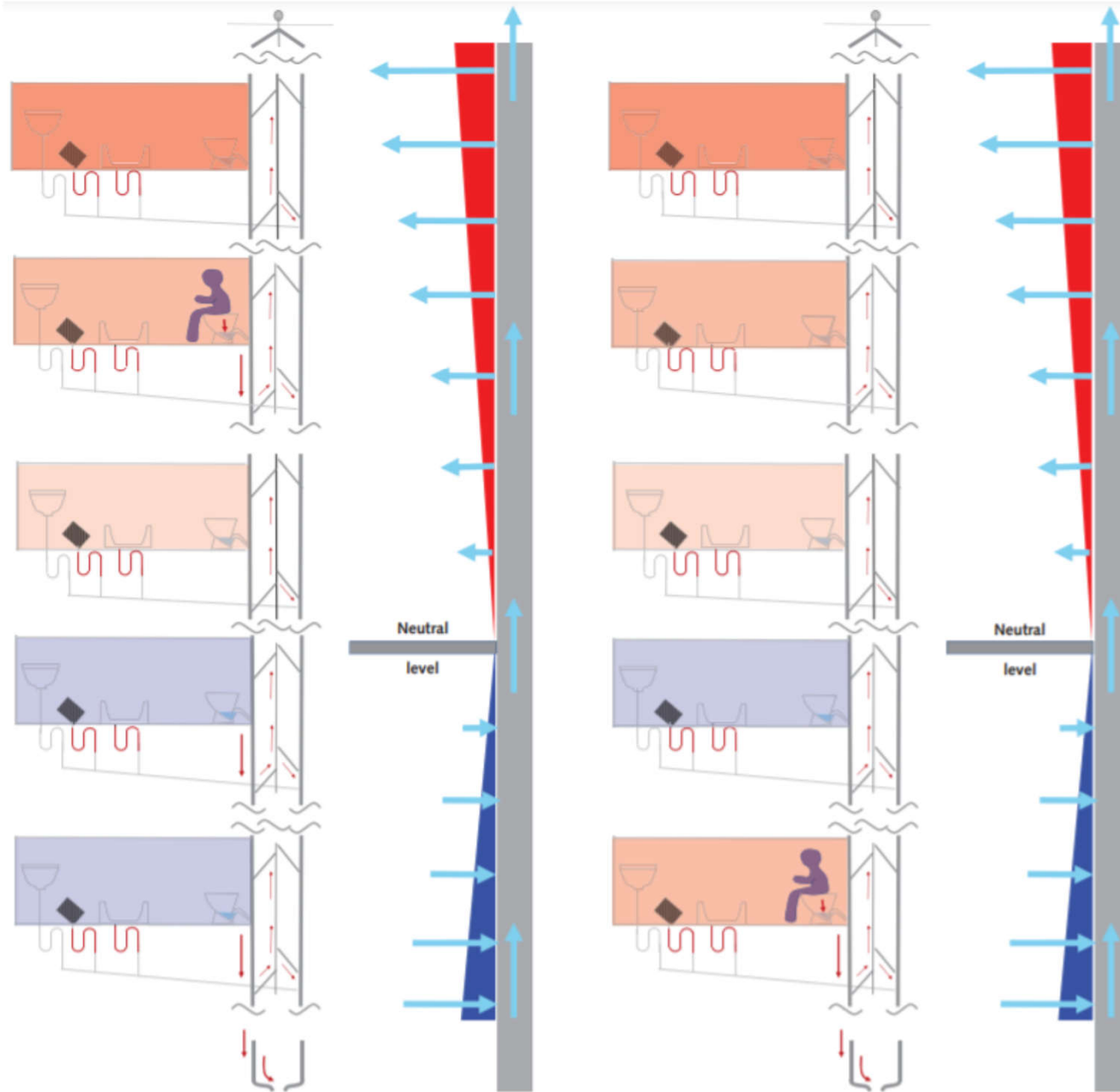

Buoyancy  
(chimney) effect  
浮力 (煙囪)  
效應

# Principle stack effect diagrams

## a) Stack effect

## b) Reverse stack effect

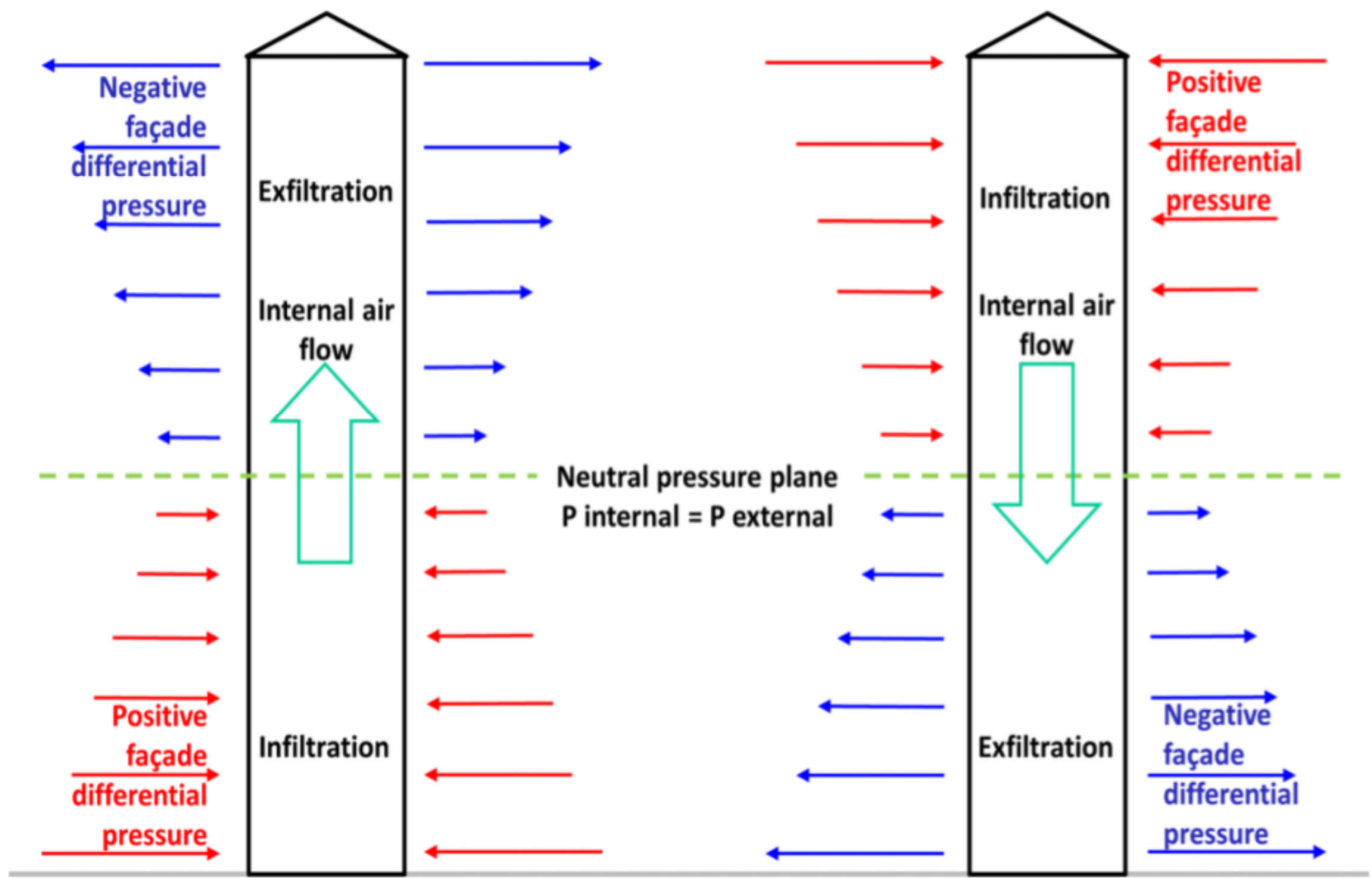

# Wind pressure impact over building stack effect

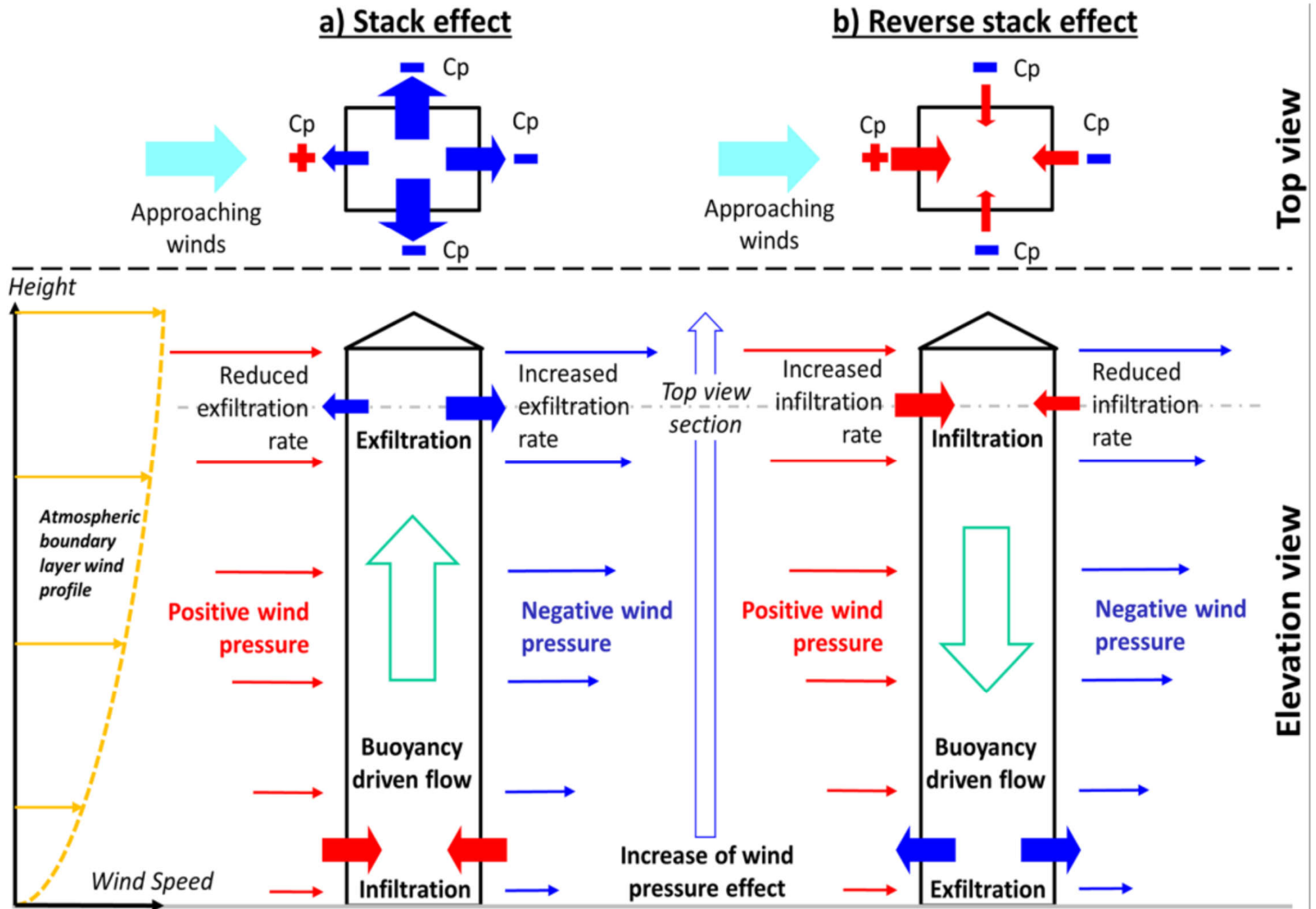

# Test and track COVID-19 in sewage & drainage manholes

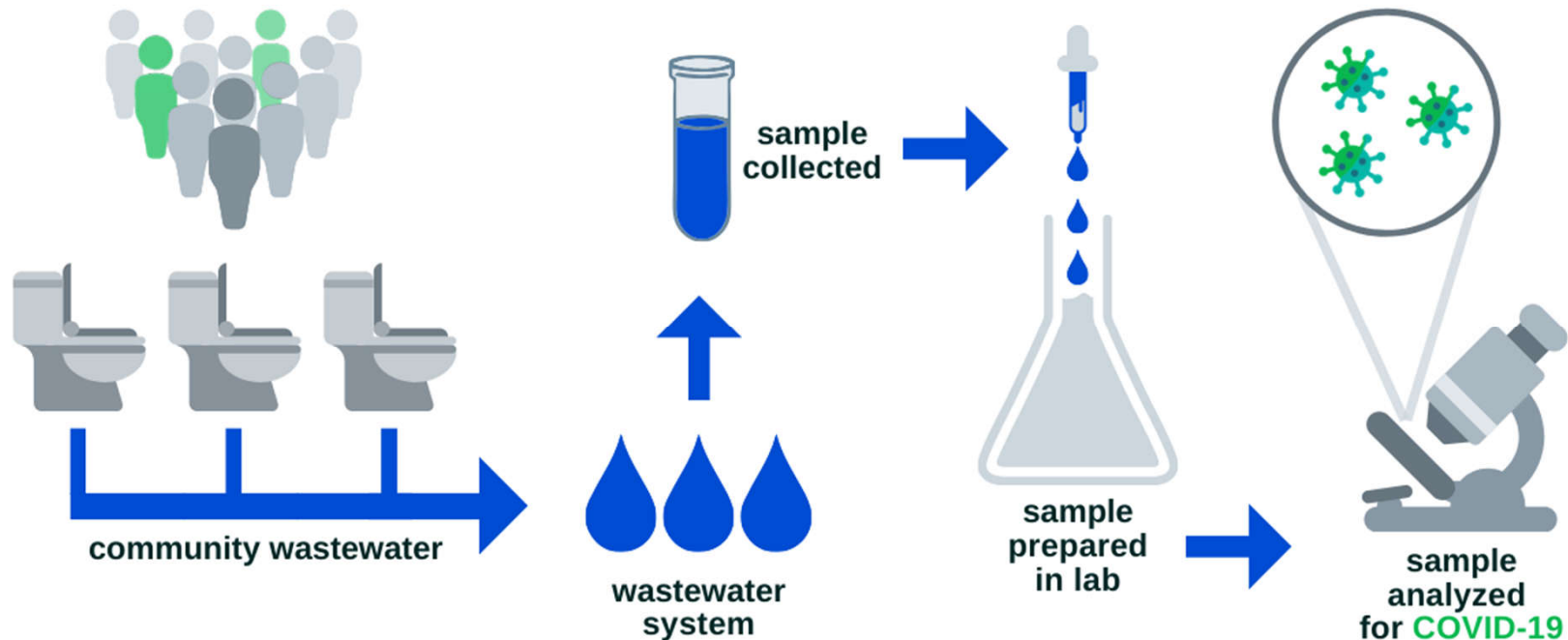

(Image source: UK plans to track spread of coronavirus in sewage <https://www.ft.com/content/e6ad8aa0-47ad-4ac1-b7f5-3375ab7d7ea6> & <https://www.azbio.org/tempe-halden-covid-19-wastewater>)

# How a sewage system could spread coronavirus

Officials are investigating whether a detached vent pipe is to blame for new infections.

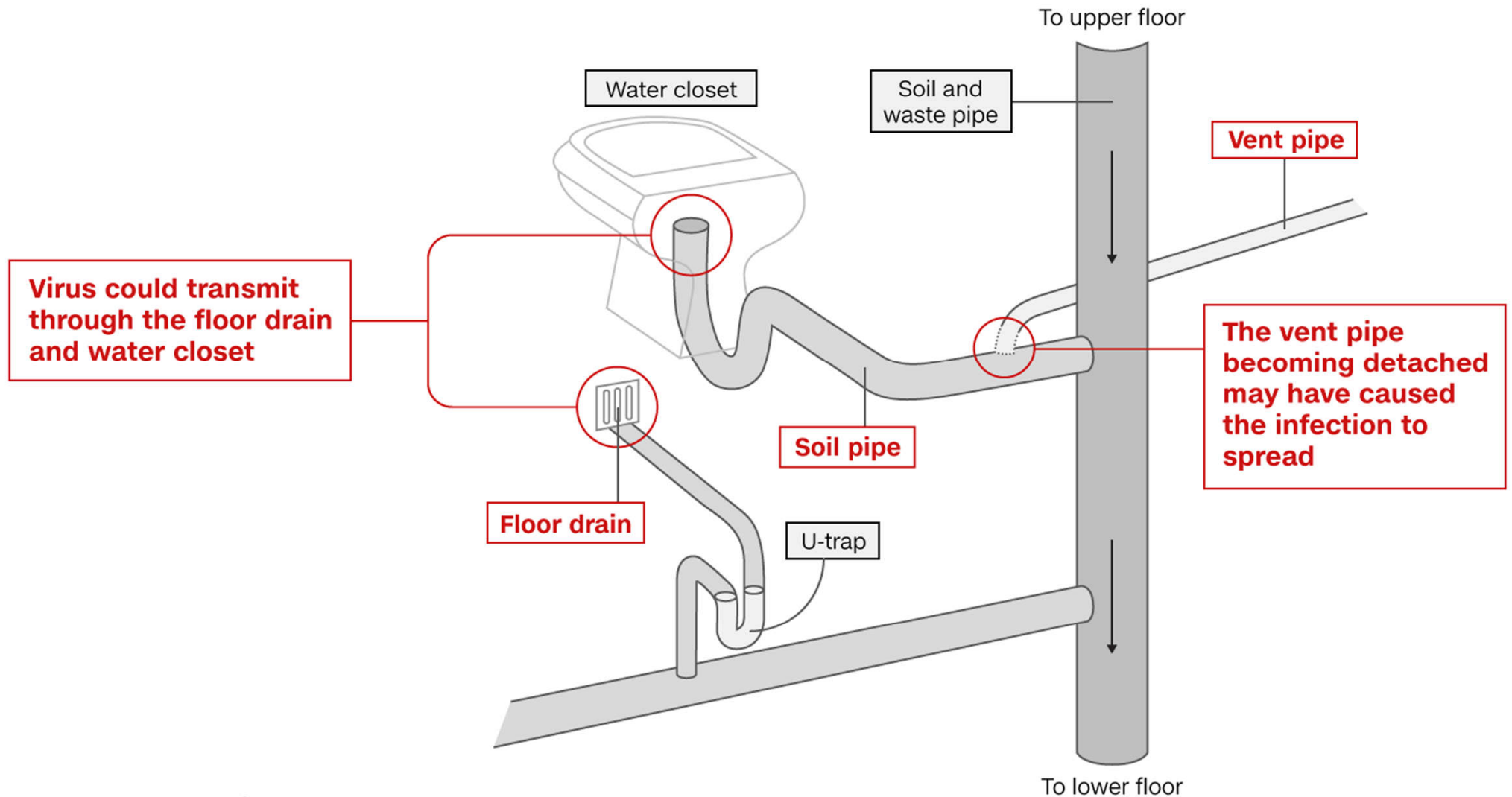

CNN Source: CNN reporting  
Graphic: Jason Kwok, CNN

(Source: <https://edition.cnn.com/2020/02/12/asia/hong-kong-coronavirus-pipes-intl-hnk/index.html>)

Legend 圖例

- Waste Pipe 廢水管
- Soil Pipe 便溺污水管
- Soil & Waste Stack 垂直污水 / 廢水管
- Vent Pipe 通風管
- Waste Water Discharge 廢水排放

Presence of Water Seal  
Prevents Entry of Odour / Vectors  
保持水封可以防止臭氣或帶菌昆蟲進入

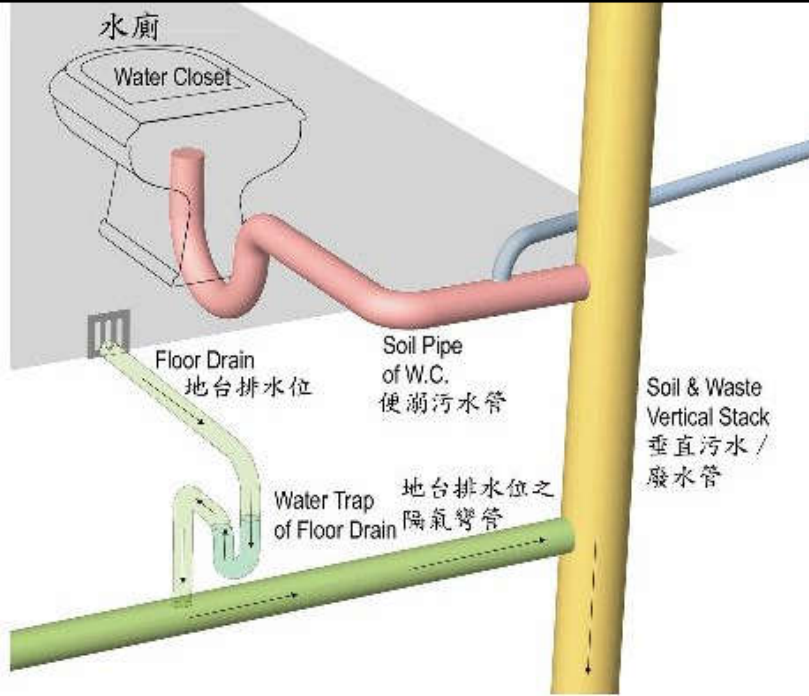

Loss of water seal  
allows entry of  
odour/vectors

Legend 圖例

- Waste Pipe 廢水管
- Soil Pipe 便溺污水管
- Soil & Waste Stack 垂直污水 / 廢水管
- Vent Pipe 通風管
- Entry of Odour / Vectors 臭氣或帶菌昆蟲入口

Loss of Water Seal  
Allows Entry of Odour / Vectors  
水封流失令臭氣或帶菌昆蟲進入

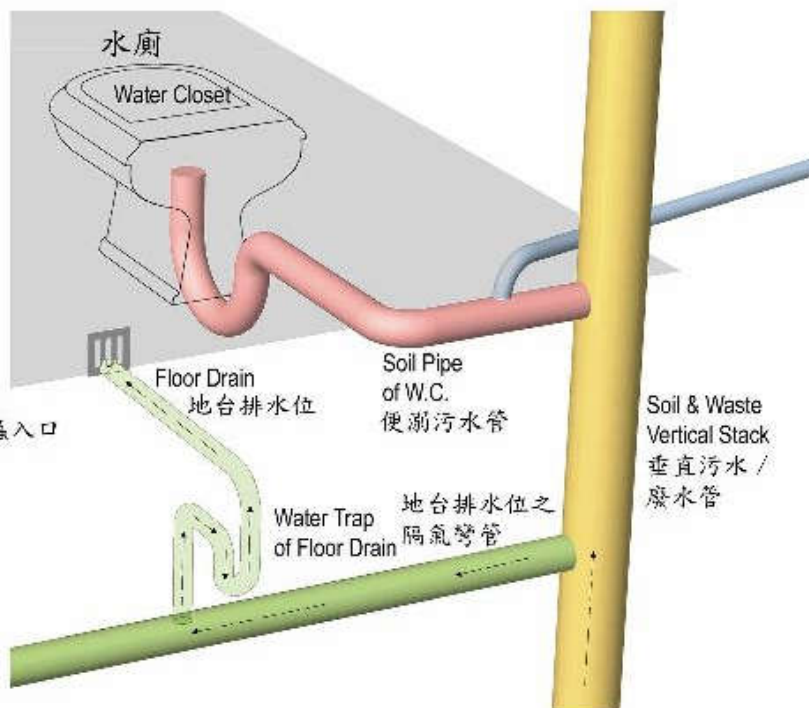

# Important issues



- Do you still remember SARS in 2003?
  - SARS disease might have spread because the U-trap of the floor drain dried out at the Amoy Garden (淘大花園)
  - How to prevent this?
    - Anti-siphonage pipes and traps
    - Back-filling arrangement
    - W-trap (proposed by the Housing Authority)
    - Self-refilling function



# Amoy Garden Block E 淘大花園E座

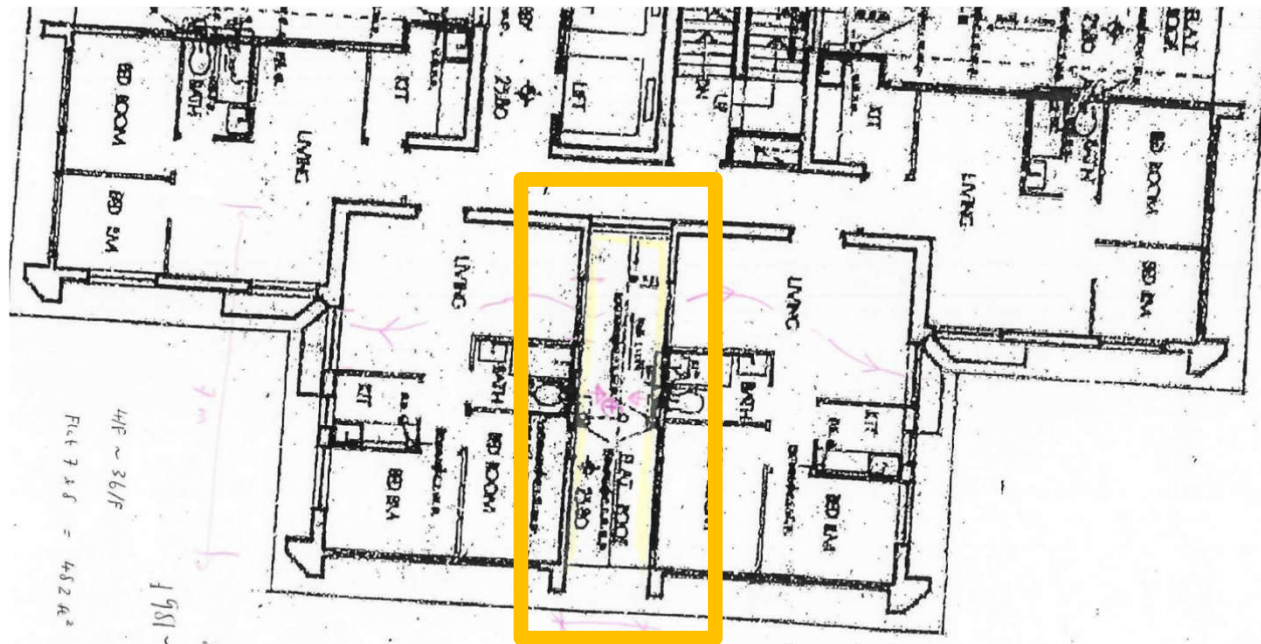
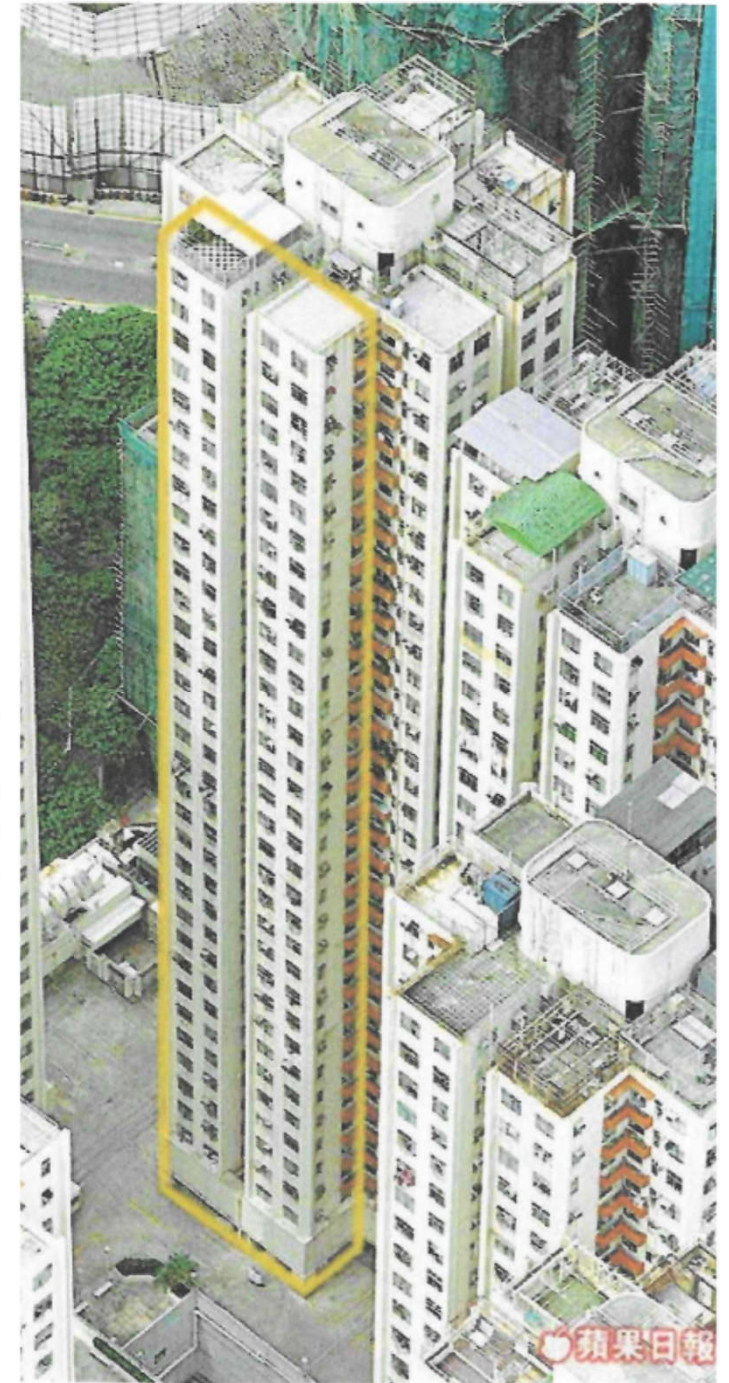

(Source: HKU SARS research team)

# SARS infection and transmission 沙士感染和傳播方式

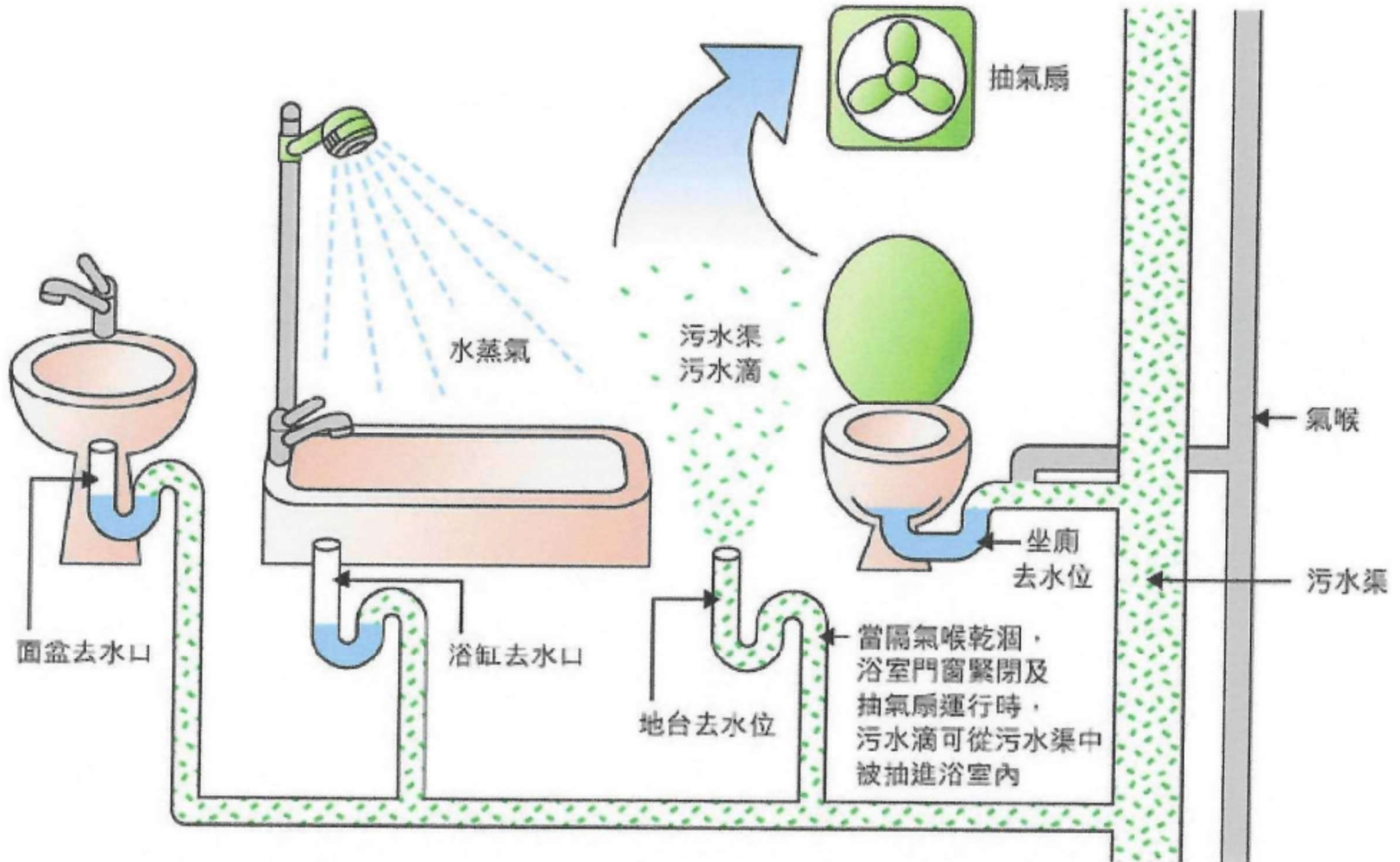

# Model which explains the infection pattern and transmission of SARS

## 解釋SARS感染方式和傳播的模型

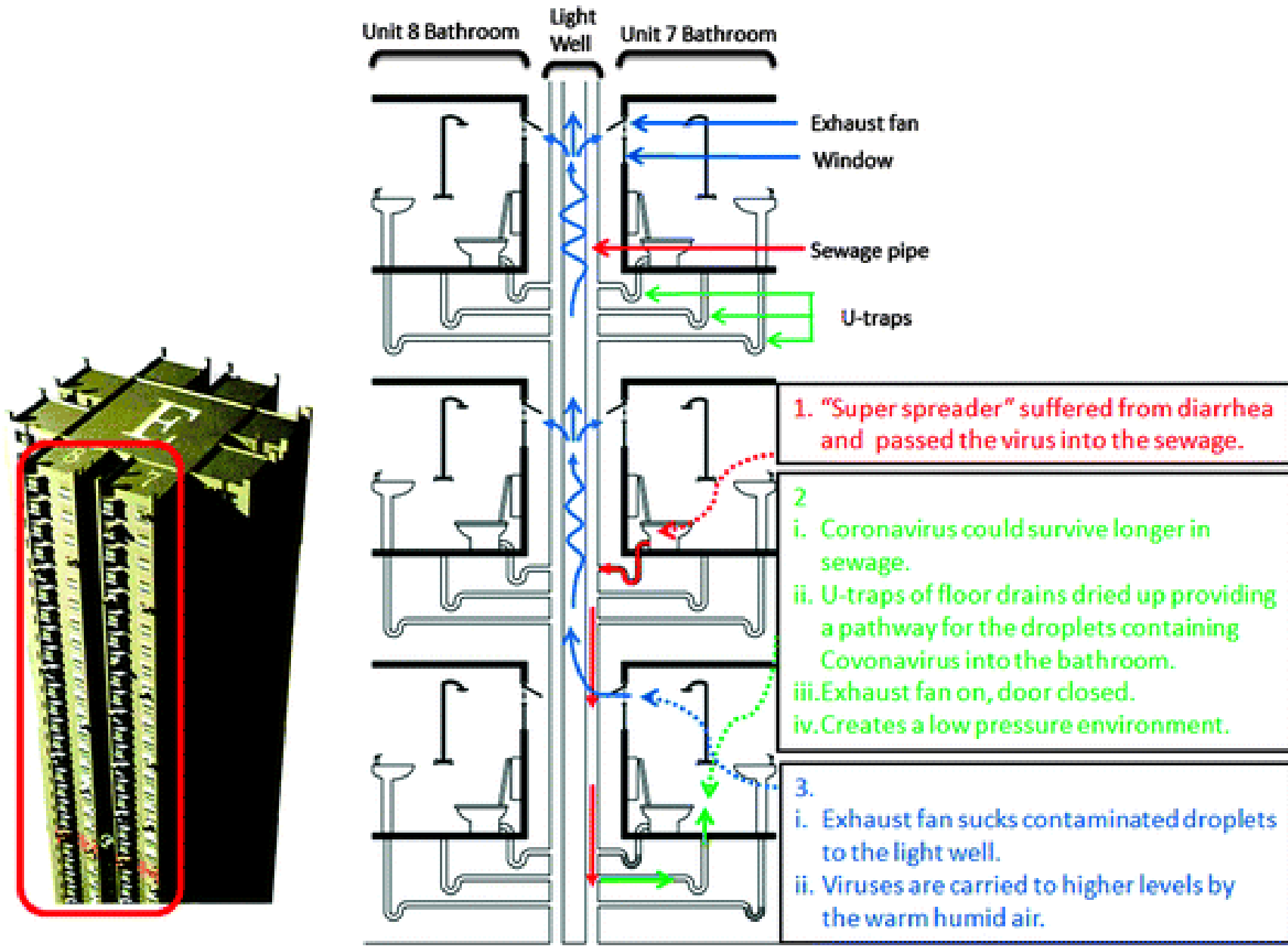

(Source: Wong A. S. L., Cheng M. M. W. & Yip V. W. Y., 2013. Scientific models in the Severe Acute Respiratory Syndrome (SARS) research and in the biology curriculum, In: Treagust D. & Tsui C. Y. (eds), *Multiple Representations in Biological Education: Models and Modeling in Science Education*, Vol 7., Springer, Dordrecht. [https://doi-org.eproxy.lib.hku.hk/10.1007/978-94-007-4192-8\\_13](https://doi-org.eproxy.lib.hku.hk/10.1007/978-94-007-4192-8_13))

# Pathogen cross-transmission via building sanitary plumbing systems

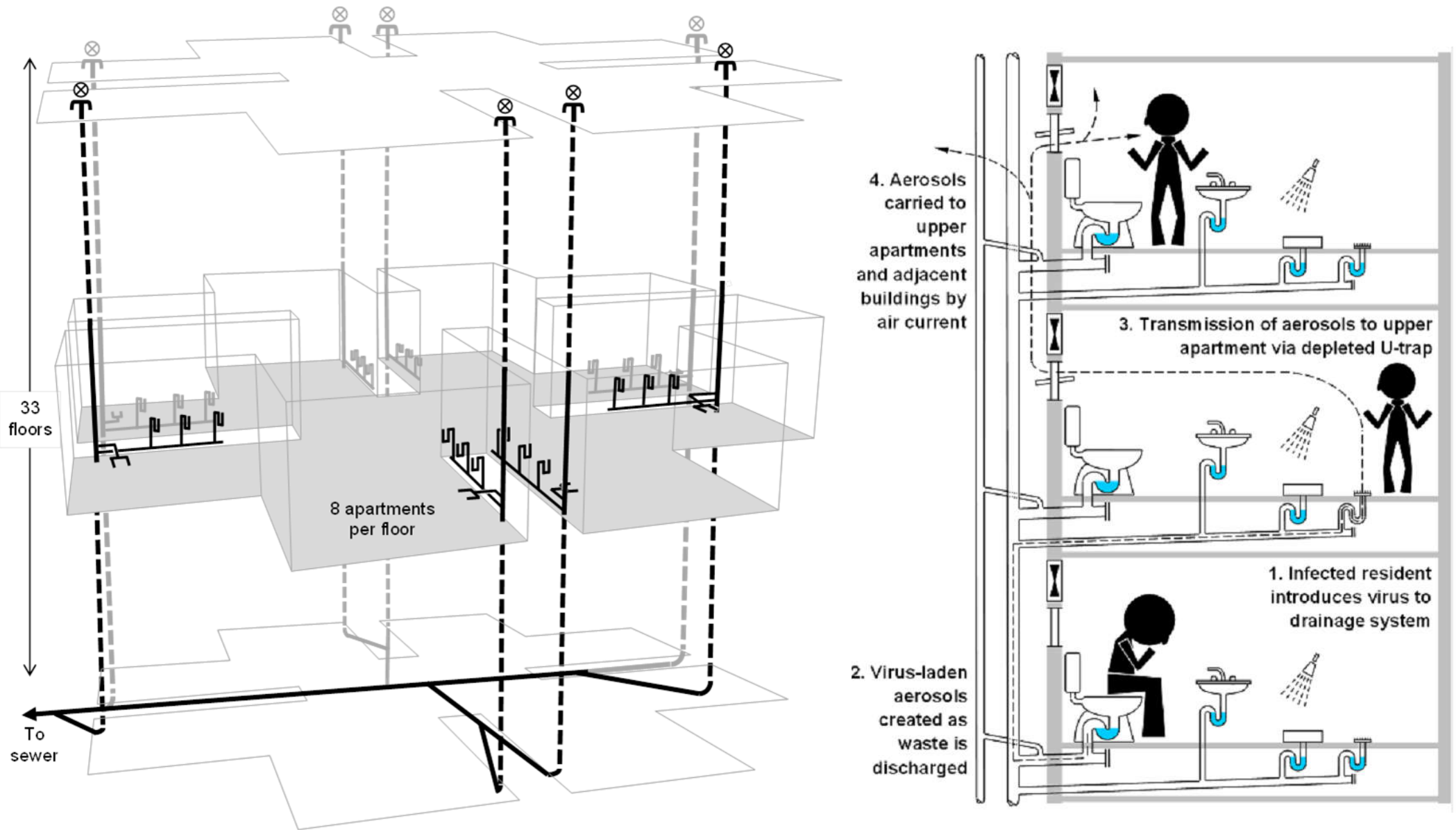

(Source: Gormley M., Aspray T. J., Kelly D. A. & Rodriguez-Gil C., 2017. Pathogen cross-transmission via building sanitary plumbing systems in a full scale pilot test-rig, *PLoS ONE*, 12 (2) e0171556. <https://doi.org/10.1371/journal.pone.0171556>)

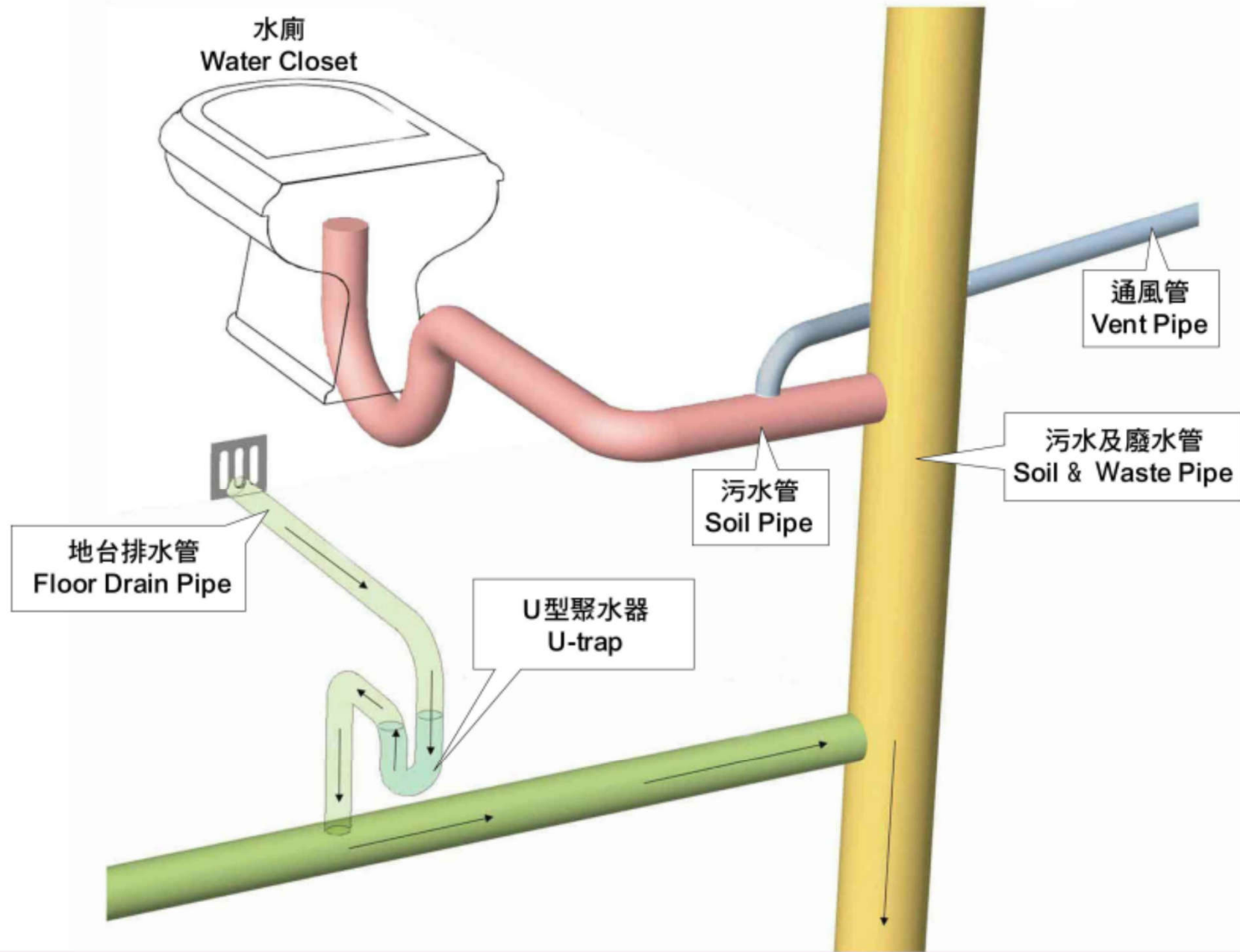

## 一般地台排水設計 General Pipe Work Design

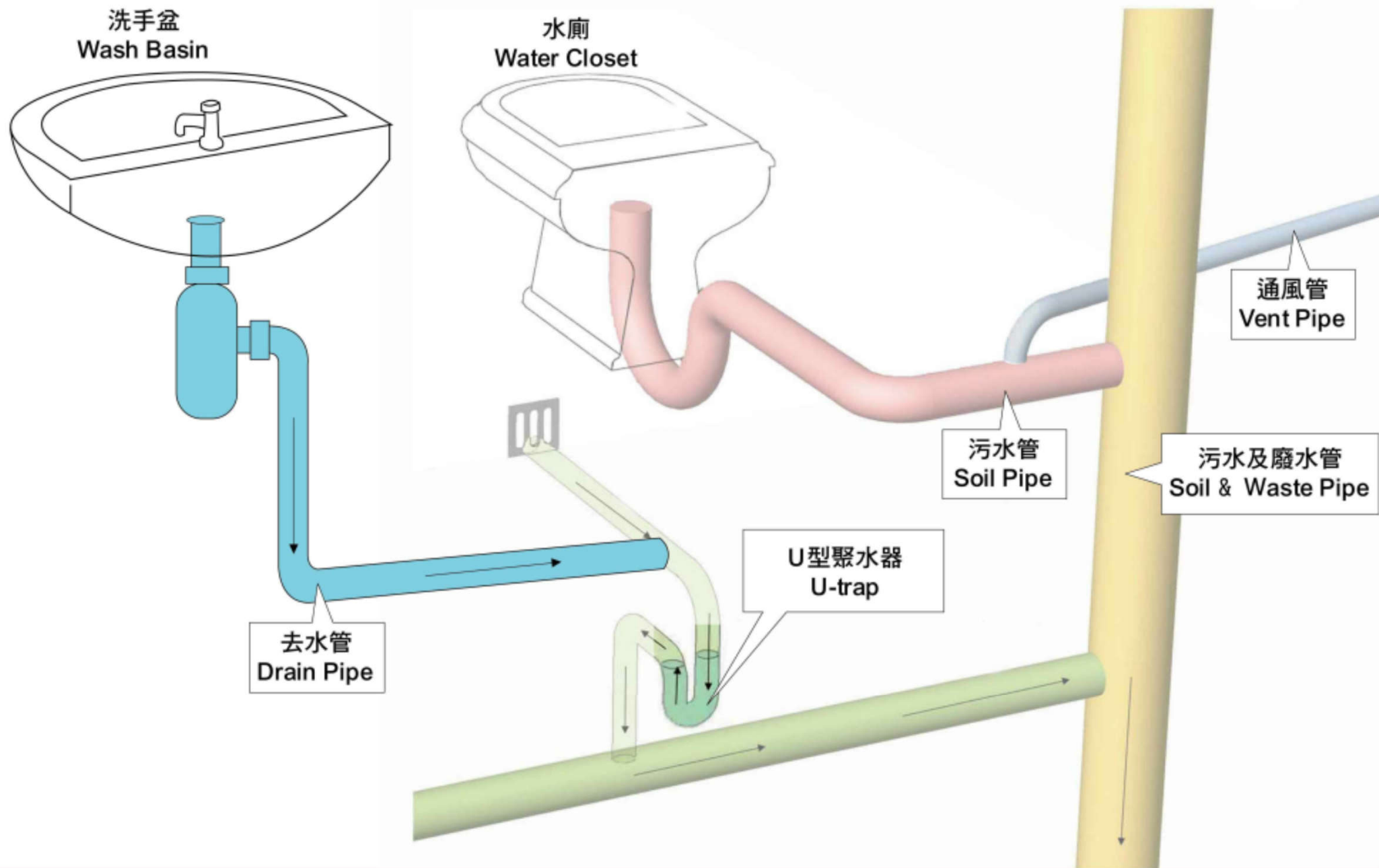

## U型聚水設計 U-trap Refilling Design

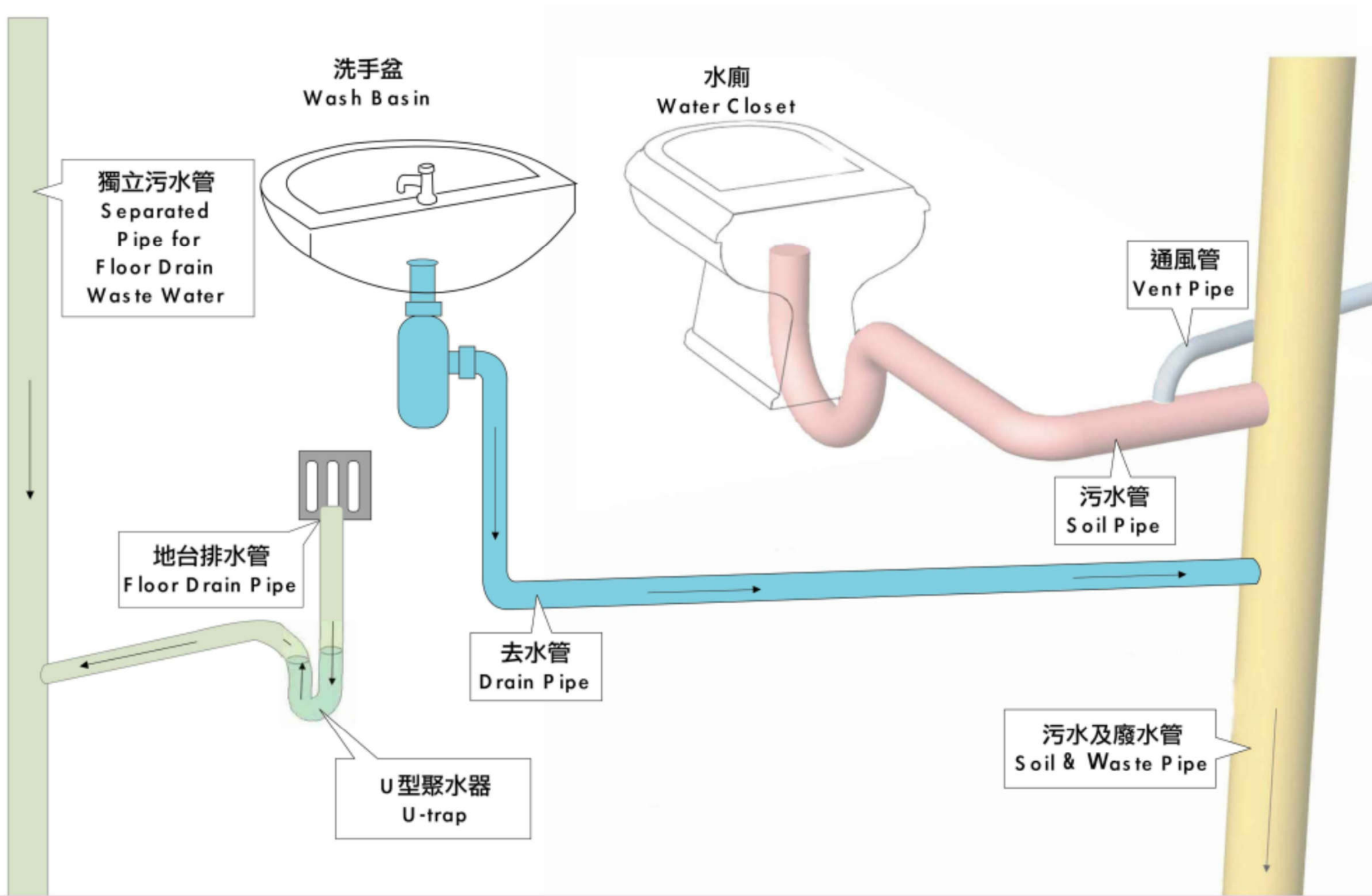

## 分開喉管設計 Pipes Separation Design

# W-trap (proposed by the Housing Authority)

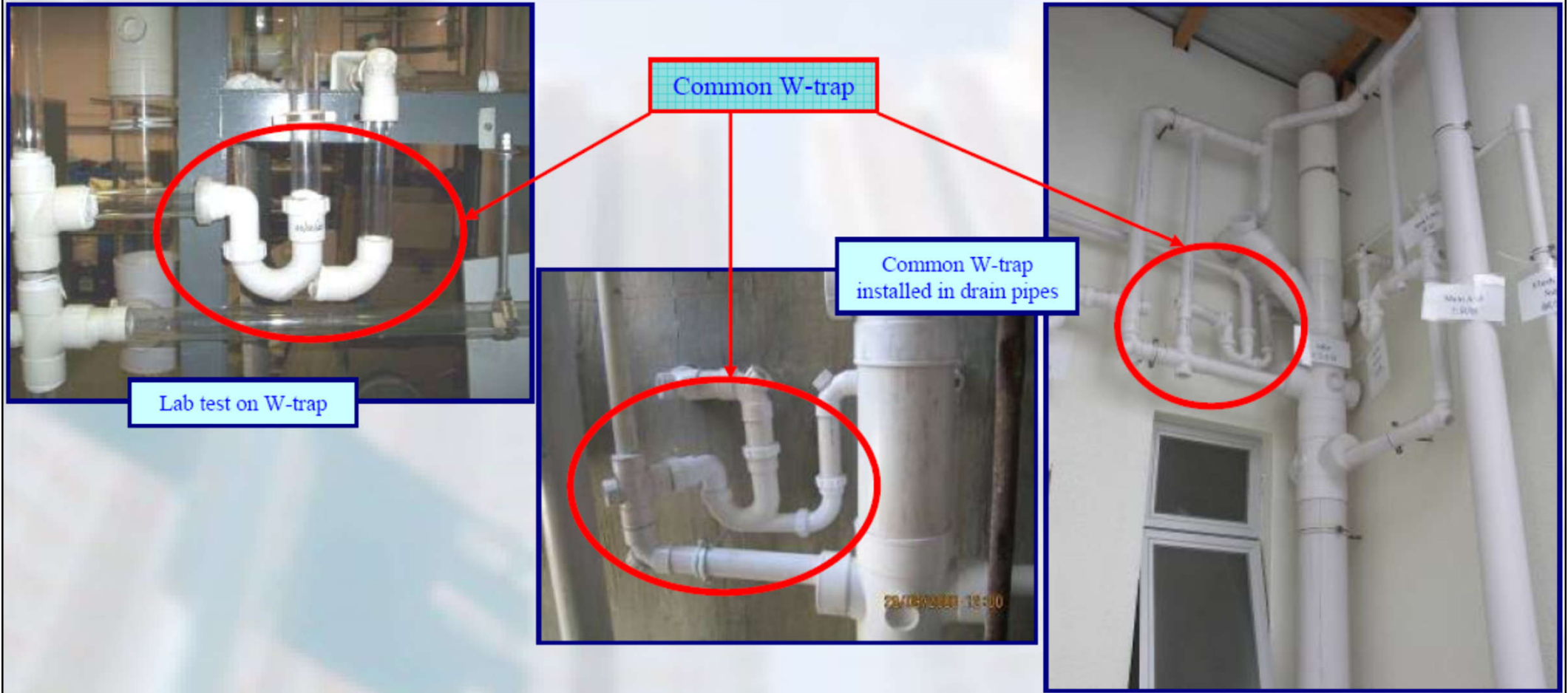





# Further Reading

- DRAINAGE Title 01 (28:55)  
<https://youtu.be/BrBqoTutZfI>
  - The evolution history in the UK
  - Current practices:
    - Problems of siphonage and the use of traps
    - Two pipe and single stack systems
    - Combined and separate drainage systems
    - Modern pipework and fittings
    - Trenches and pipe protection
    - Inspection chambers
    - Building regulations
  - Modern sewage treatment plant



This gives an overview of the design issues for drainage systems.

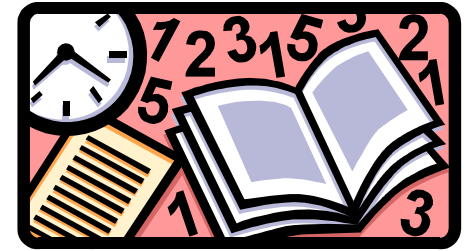

# References

- Burberry, P., 1997. *Environment and Services*, 8th ed., Chps. 10 & 12, Addison Wesley Longman, Essex.
- Chadderton, D. V., 2007. *Building Services Engineering*, 5th ed., Chps. 7-9, E & FN Spon, London & New York.
- CIBSE, 2014. *Public Health and Plumbing Engineering*, CIBSE Guide G, Chartered Institution of Building Services Engineers (CIBSE), London.
- Clifton L., 2020. *Methods of Venting Plumbing Fixtures and Traps in the 2021 IPC*, International Code Council (ICC), Washington, DC. [https://www.iccsafe.org/wp-content/uploads/20-18927\\_GR\\_2021\\_Plumbing\\_Venting\\_Brochure.pdf](https://www.iccsafe.org/wp-content/uploads/20-18927_GR_2021_Plumbing_Venting_Brochure.pdf)

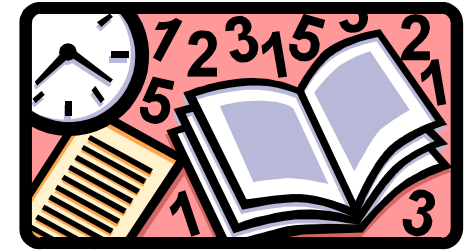

# References

- DSD, 2018. *Stormwater Drainage Manual: Planning, Design and Management*, 5th ed., Drainage Services Department (DSD), Hong Kong.  
[https://www.dsd.gov.hk/EN/Files/Technical\\_Manual/technical\\_manuals/Stormwater\\_Drainage\\_Manual\\_Eurocodes.pdf](https://www.dsd.gov.hk/EN/Files/Technical_Manual/technical_manuals/Stormwater_Drainage_Manual_Eurocodes.pdf)
- Hall F. & Greeno R., 2017. *Building Services Handbook*, 9th ed., Routledge, Oxon & New York.
- IOP, 2002. *Plumbing Engineering Services Design Guide*, [New ed.], Institute of Plumbing, Hornchurch, Essex, UK.