

# MEBS6000 Utility Services

<http://ibse.hk/MEBS6000/>



## Fuel Gas Supply



*Ir Dr. Sam C. M. Hui*

Department of Mechanical Engineering

The University of Hong Kong

E-mail: [cmhui@hku.hk](mailto:cmhui@hku.hk)

Jan 2024

# Contents



- Introduction
- Gas supply in Hong Kong
- System components
- Design considerations
- Gas pipe sizing



# Introduction



燃氣

- **Fuel gas:** fuels in gaseous form, e.g. coal gas
  - Many fuel gases are composed of hydrocarbons (e.g. methane or propane), hydrogen, carbon monoxide, or mixtures thereof
  - Can be transmitted and distributed through pipes
  - Combustion at the point of use
  - Cleaner than solid (e.g. coal) and liquid (oil) fuels
  - Gas lighting is the earliest application in HK
    - Such as Duddell Street, Central, HK (都爹利街煤氣燈)

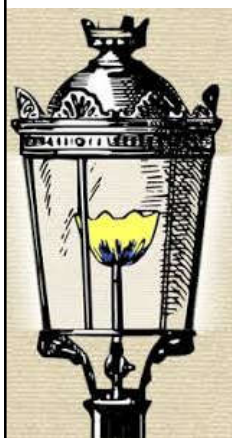

- Video: Gas Street Lamps (4:46) <https://youtu.be/ZJO99leDtwM>

- Video: 地下秩序：地下氣息 (21:21) <https://www.bilibili.com/video/BV1Us41127tz/>

# Gas appliances in early history of Hong Kong

威能牌熱水爐  
Vaillant bath stove  
c.1930



銅製煤氣熱水器  
Copper gas geyser  
c.1900



真佳牌無煙道式熱水爐  
Junkers flueless water heater  
c.1960



威能牌煤氣熱水爐  
Vaillant bath stove



煤氣風扇  
Gas-powered fan



輻射熱碗暖爐  
Radiant bowl heater



中式爐具  
Chinese cookers  
c.1929



John Wright 煮食焗爐  
John Wright gas cooker  
c.1878



Ewart 熱水器  
Ewart Califont geyser  
c.1920



# Introduction



- Three broad types of fuel gas:
  - Manufactured gas 合成氣
    - Produced from coal and coke, through an artificial process (gasification), e.g. coal gas, town gas, biogas
  - Liquefied petroleum gas (LPG, bottle gas) 石油氣
    - From petroleum refining or natural gas processing
    - Butane ( $C_4H_{10}$ ) or propane ( $C_3H_8$ ), or a mixture of both
  - Natural gas 天然氣
    - A naturally occurring hydrocarbon gas mixture consisting primarily of methane ( $CH_4$ )

# Introduction



- History of gas: making gas from coal & oil
  - Revitalisation of natural gas in the world, e.g. discovery in South China Sea & North Sea (UK)
- Common types: town gas, LPG, natural gas
  - Conveyed in a one-way pipe system; typical pressure: 1-2 kN/m<sup>2</sup>
- Risk of gas explosion! Safety is very important
  - Chemical scent/odour is added to most fuel gases so that they may be detected by a distinct smell



Do you remember these accidents in HK? What type of gas is this?



Gas explosion accident in  
Ngau Tau Kok (11/4/2006)

([http://zoniaeuropa.com/20060412\\_1.htm](http://zoniaeuropa.com/20060412_1.htm))



Gas explosion accident in  
Tsui Chuk Garden,  
Wong Tai Sin (30/10/2002)



What about the gas explosion in  
Kaohsiung, Taiwan in July 2014?

(See also: [http://en.wikipedia.org/wiki/2014\\_Kaohsiung\\_gas\\_explosions](http://en.wikipedia.org/wiki/2014_Kaohsiung_gas_explosions))



## Three types of common fuel gases

Town gas	Natural Gas	LPG
<ul style="list-style-type: none"> <li>• Made from naphtha and natural gas; mainly nitrogen, methane, carbon dioxide and a small amount of carbon monoxide (poisonous)</li> <li>• Lighter than air (specific gravity 0.52)</li> <li>• CV = 17-18 MJ/m<sup>3</sup></li> <li>• Flammable limits 4.5%-44.3%</li> <li>• Wobbe index = 22-30</li> <li>• Higher burning velocity than natural gas</li> <li>• Distributed in pipes (at 10-20 mbars)</li> </ul>	<ul style="list-style-type: none"> <li>• Natural reserve</li> <li>• Mainly methane</li> <li>• Almost free of CO</li> <li>• Lighter than air (specific gravity 0.61)</li> <li>• CV = 37-42 MJ/m<sup>3</sup></li> <li>• Flammable limits 5%-15%</li> <li>• Wobbe index = 39-55</li> <li>• Lower burning velocity than town gas</li> <li>• Distributed at higher pressure (15-25 mbars) than town gas</li> </ul>	<ul style="list-style-type: none"> <li>• Made from petroleum</li> <li>• Propane and butane</li> <li>• Heavier than air (specific gravity 1.92) (tend to accumulate at floor or low level)</li> <li>• CV = 95-116 MJ/m<sup>3</sup></li> <li>• Flammable limits 1.8%-9.5%</li> <li>• Wobbe index = 73-87</li> <li>• Distributed in cylinder or pipes</li> </ul>

\* CV = calorific value (i.e. heat energy content)

Wobbe index: an indicator of the interchangeability of fuel gases, to compare the combustion energy output



# Gas supply chain (natural gas)

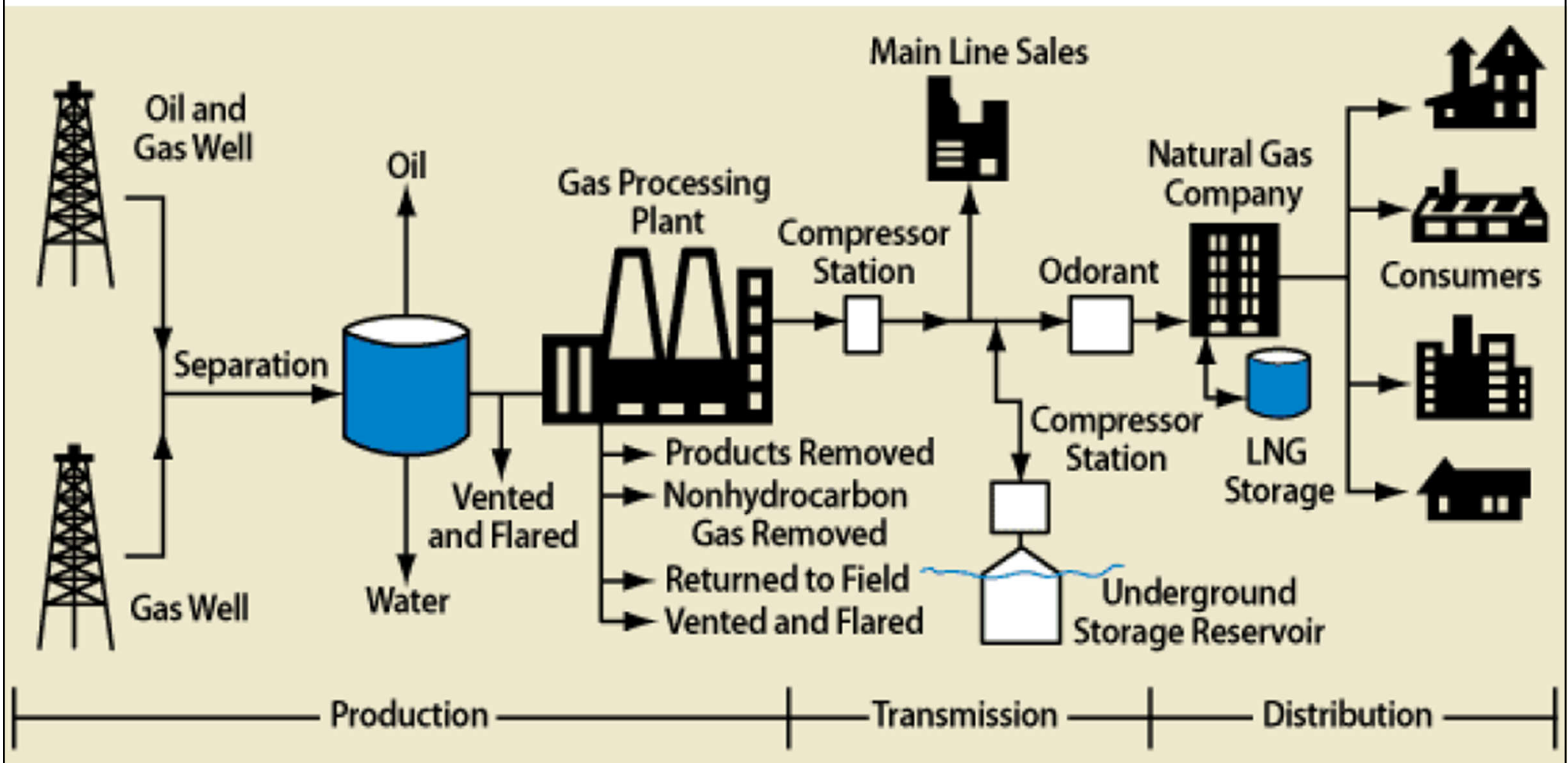

# Introduction



- Main elements in fuel gas supply:



- Production & importation: Fuel gas is produced & imported from offshore fields or other countries
- Transmission: Reception terminals receive gas from producers & is then supplied to transmission system after quality checks
- Distribution: Transported in distribution networks
- Supply: Delivered to the end user through a pipe owned by the local distribution network



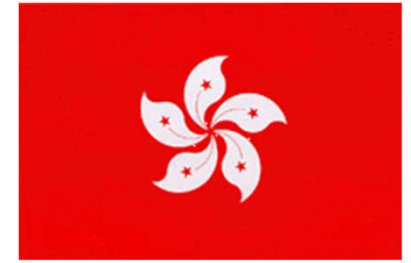

# Gas supply in Hong Kong

- Town gas and LPG are the main types of fuel gas used in Hong Kong for domestic, commercial and industrial purposes (~2.25 million gas customers)
  - Piped gas supply, discouraging LPG cylinders
- LPG is also used as a fuel by nearly all taxis and over 65% of public light buses
- Natural gas is used for electricity generation and production of town gas



# Gas supply network in Hong Kong

Do you know where are the natural gas & LPG come from?



(Natural gas supply to HK: <http://www.legco.gov.hk/yr12-13/english/panels/e/dev/papers/e/dev0108cb1-401-1-e.pdf>)

(Source: EMSD)

\* 資料至2012年  
Data to 2012

# Natural gas facilities in Hong Kong



# 氣體供應鏈

# Gas Supply Chain



(Source: EMSD)

## Types of fuel gases and their properties

	Town Gas	Liquefied Petroleum Gas
Materials / Components	Feedstocks: Naphtha and natural gas Constituents: hydrogen, methane, carbon dioxide, and a small amount of carbon monoxide, nitrogen and oxygen	Propane and butane
Calorific Value (MJ/m <sup>3</sup> )	17.27	116
Flammable Limits	4.5 ~ 44.3%	1.8 ~ 9.5%
Wobbe Index	24	84
Toxicity	Toxic	Non-toxic
Weight	0.52 times the weight of air	1.91 times the weight of air
Supply Method	It is supplied through a network of pipelines.	It is centrally supplied through a network of pipelines or stored in a cylinder in liquid form.

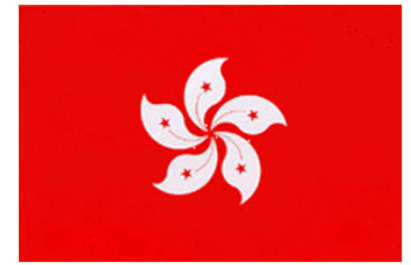

# Gas supply in Hong Kong

- Types of fuel gas

- Town gas (89.1% market in 2022)



煤氣  
Towngas



- Hong Kong and China Gas Company Limited
    - 1.96 million customers; 27.6 million MJ town gas sales
    - Even split between domestic & commercial/industrial
    - Production plants: at Tai Po (97%) & Ma Tau Kok (3%)
    - Using “naphtha” and liquefied natural gas (LNG) as feedstock (also some landfill gas)
    - High pressure pipeline & distribution network (3700 km pipe network)



# Towngas network in Hong Kong

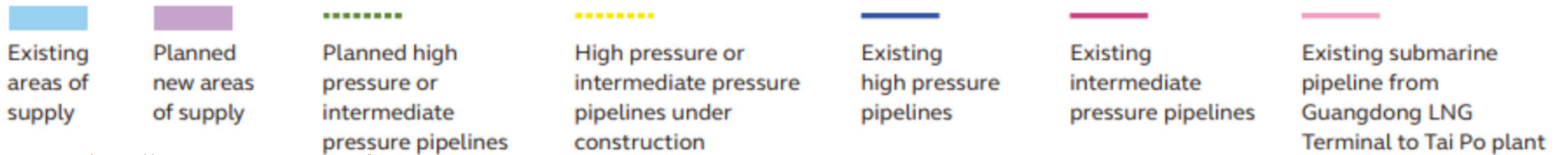

(Source: <http://www.towngas.com/>)

# Town Gas Characteristics

<b>Chemical Composition</b>	<b>%</b>
Carbon Dioxide	16.3 - 19.9
Carbon Monoxide	1.0 - 3.1
Methane	28.2 - 30.7
Hydrogen	46.3 - 51.8
Nitrogen and Oxygen	0 - 3.3
<b>Physical Properties</b>	
Calorific Value	17.27 MJ/m <sup>3</sup>
Specific Gravity	0.52
Wobbe Index	24.0 MJ/m <sup>3</sup>
Weaver Flame Speed Factor	35.0

# Typical gas supply arrangement in high-rise buildings with remote bulk meter and secondary meters within individual dwellings

ECV = emergency control valve  
 AECV = additional emergency control valve

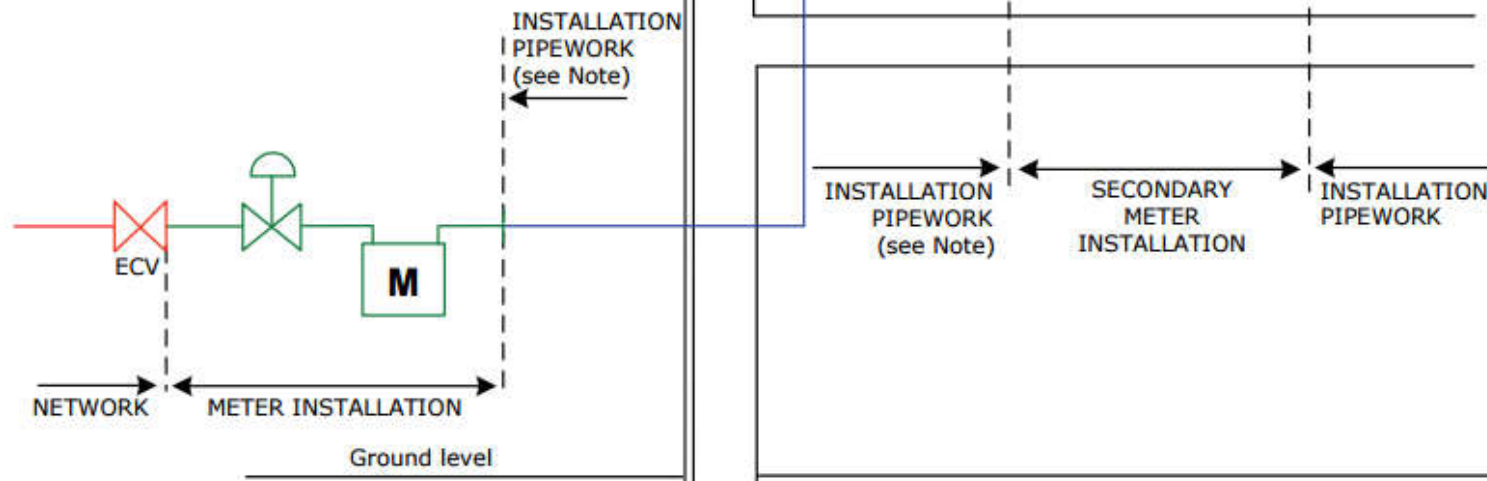

A = appliance  
 M = meter

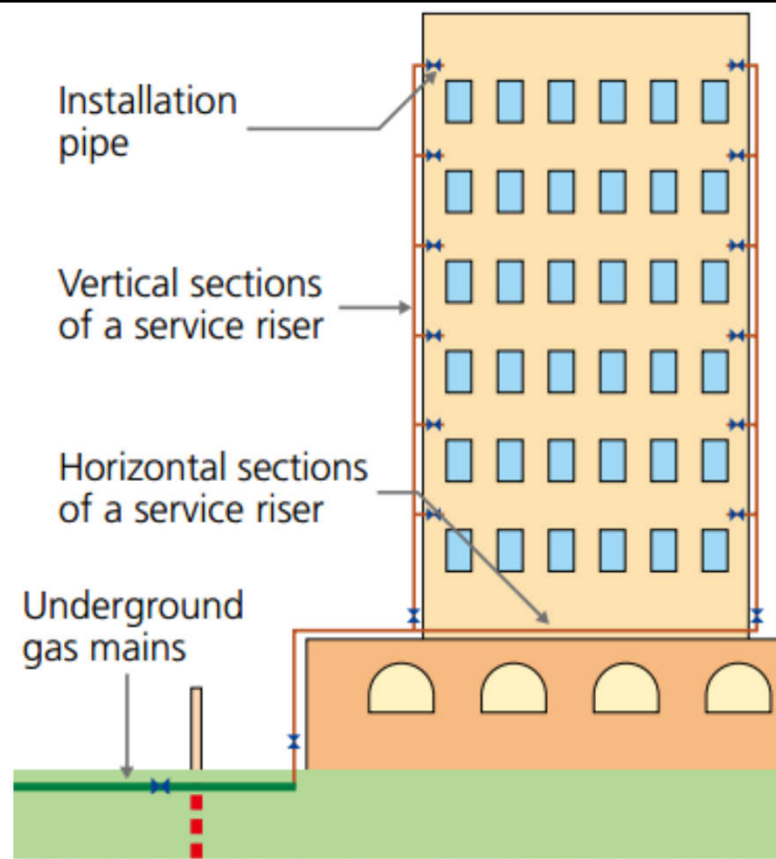

A service valve



A town gas pipe duct

(Source: EMSD)



Figure 1: Vertical sections of a service riser

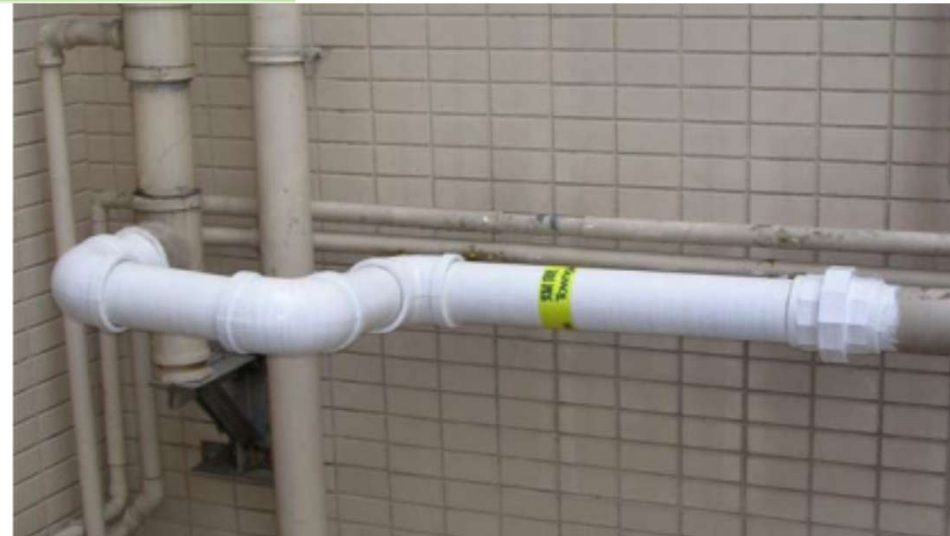
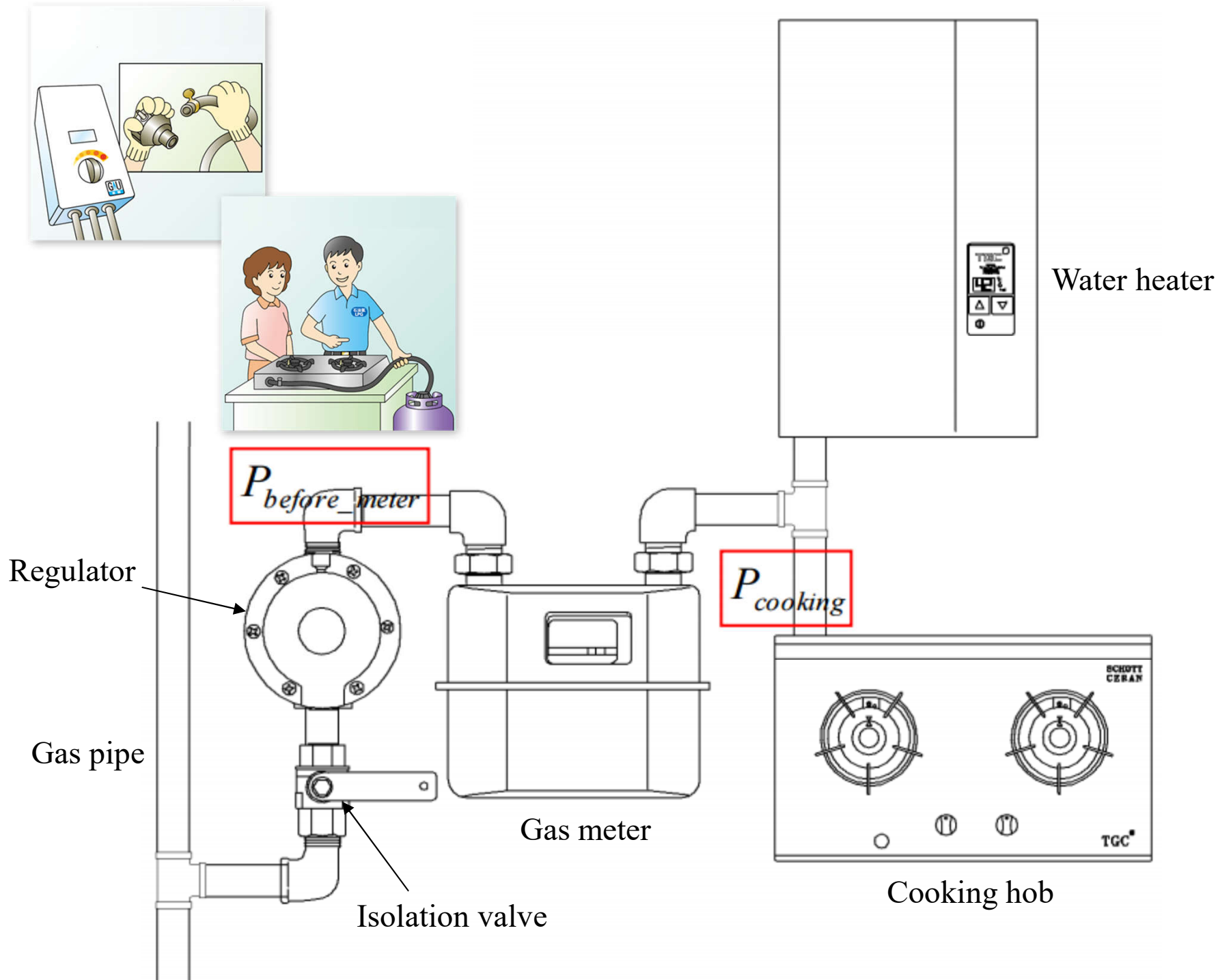

Figure 2: Horizontal sections of a service riser



Figure 3: An installation pipe and gas fittings

# Example of a residential town gas installation



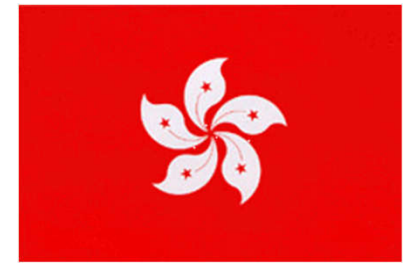

# Gas supply in Hong Kong

- Types of fuel gas (cont'd)
  - LPG (10.9% market in 2022)

Have you used LPG  
at home before?



- Liquefied butane ( $C_4H_{10}$ ) or propane ( $C_3H_8$ )
- Suppliers: Caltex, Penninsula, Concord, Sinopec, Esso/Mobil, Shell/BP, New Ocean
- Imported into Hong Kong by sea and stored in 5 terminals on Tsing Yi Island
- Some 350,000 customers + 70 LPG filling stations
- About 59% sales in cylinders; others in piped systems
- Safety issues **VERY IMPORTANT!** (explosion)
  - Danger to their own, vicinity & firemen



# Make use of the services provided by the approved LPG distributors

## 為何市民應使用獲批准分銷商提供的服務？

### Why should members of the public make use of services provided by the approved distributors?

市民若向未獲批准的分銷商獲取服務，他們不但無法享有合乎水平的服務，亦可能會導致自己、家人、鄰居及其他人士不必要地面臨潛在的氣體危機。為安全理由，市民應辨別那些是獲有關註冊氣體供應公司批准的分銷商並選取它為你提供服務。

If members of the public make use of services from the non-approved distributors, not only they will fail to enjoy the quality services, but may also unduly expose themselves, their family members, neighbours and other persons to potential

gas risks. For safety reasons, please identify the distributors approved by the respective registered gas supply companies to serve you.



## 市民如何辨別獲批准的分銷商？

### How can members of the public identify an approved distributor ?

辨別獲批准的分銷商的方法：

- (1) 店舖內展示由所屬註冊氣體供應公司發出的證明書及
- (2) 發票上顯示註冊氣體工程承辦商號碼。



### Approved distributor may be identified by:

- (1) the certificate issued by the respective registered gas supply company displayed in the shop; and
- (2) the registered gas contractor number shown on the invoice.

### 有哪些查詢途徑？

#### Any means of making enquiry?

市民可直接聯絡註冊氣體供應公司，或致電機電工程署熱線或瀏覽其網頁。

You may contact the registered gas supply company direct, or call hotline or browse web-page of EMSD.

註冊氣體供應公司 (查詢電話) Registered Gas Supply Company (Enquiry Tel No.)	石油氣牌子 Brand of LPG
中石化 (香港) 石油控股有限公司 Sinopec (HK) Petroleum Holding Co. Ltd. 2593 7388	中石化 Sinopec
協和石油 (香港) 有限公司 Concord Oil (HK) Ltd. 2311 6788	協和 Concord
埃克森美孚香港有限公司 ExxonMobil HK Ltd. 3197 8682	標準、美孚 Esso, Mobil
香港殼牌有限公司 Shell HK Ltd. 2435 8388	殼牌 Shell
騰駿實業有限公司 Rise Smart Industrial Ltd. 2891 8961	新海 NewOcean

機電工程署查詢 EMSD Enquiry  
1823 or <http://www.emsd.gov.hk>

附註：市民可從機電工程署網頁瀏覽獲註冊氣體供應公司批准的分銷商名冊。

Remark: Members of the public may browse the register of distributors who are approved by the registered gas supply companies via EMSD web-page



再循環印刷  
Printed on recycled paper

## 使用獲批准石油氣分銷商提供的服務

### Make Use of the Services provided by the Approved LPG Distributors

既合乎安全 又得到保障  
for Safety Provision & Service Assurance



機電工程署  
EMSD



Brand Name	加德士 Caltex	半島 Peninsula	協和 Concord	中石化 Sinopec	標準 Esso	美孚 Mobil	殼牌石油氣/ 盾牌 Shell Gas/BP	新海 NewOcean
Reference Photo of LPG								

(Source: EMSD)

## 使用瓶裝石油氣的安全措施

### Safe Use of LPG Cylinders



這一系列的單張，是把氣體燃料安全的一些要點加以說明，這些要點是各位使用石油氣及煤氣的住宅用戶應該知道的。

*This series of leaflets cover some important aspects of gas safety which the domestic consumers should know when using LPG (liquefied petroleum gas) and Towngas.*

### 使用瓶裝石油氣的安全措施

在本港使用的石油氣，是丁烷氣和丙烷氣的混合氣，並無毒性，比空氣重，會在地面積聚。石油氣經壓縮後以液態儲存在方便搬運的氣瓶內，供作多種用途。

### Safe Use of LPG Cylinders

LPG in Hong Kong is a mixture of butane gas and propane gas. It is non-toxic, heavier than air, and will tend to accumulate at floor level. LPG is pressurised and stored in liquid form in portable cylinders for a variety of purposes.

### 石油氣瓶的儲存

除非有根據氣體安全條例給予的特定許可，否則在任何時間儲存標稱總容水量超過 130 升（約是標稱重量 50 公斤）的石油氣（包括空瓶），均屬違例。

下表列出一些普通型號石油氣瓶的最高許可儲存數目，以供參考。

### Storage of LPG Cylinders

Unless specifically approved in accordance with the Gas Safety Ordinance, storing LPG cylinders (including empty cylinders) with a total nominal water capacity of over 130 litres (approximately 50 kg nominal weight) at any time is an offence.



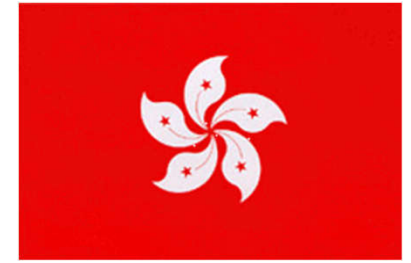

# Gas supply in Hong Kong

- LPG supply systems



- Simplest way: place a cylinder in a household
- Cylinder banks systems for small communities
  - Automatic changeover to two sets of cylinders
  - Gas supply would not be interrupted; it also indicates when replacement is required
- Large scale LPG central supply system (piped)
  - Tanks can be installed underground or above-ground
  - Bulk tank system or manifold system (LPG cylinders)
- Applications: cooking, fuel for vehicle, refrigerant

# LPG store and cylinder banks supply system



LPG system  
with single  
bulk tank  
installation

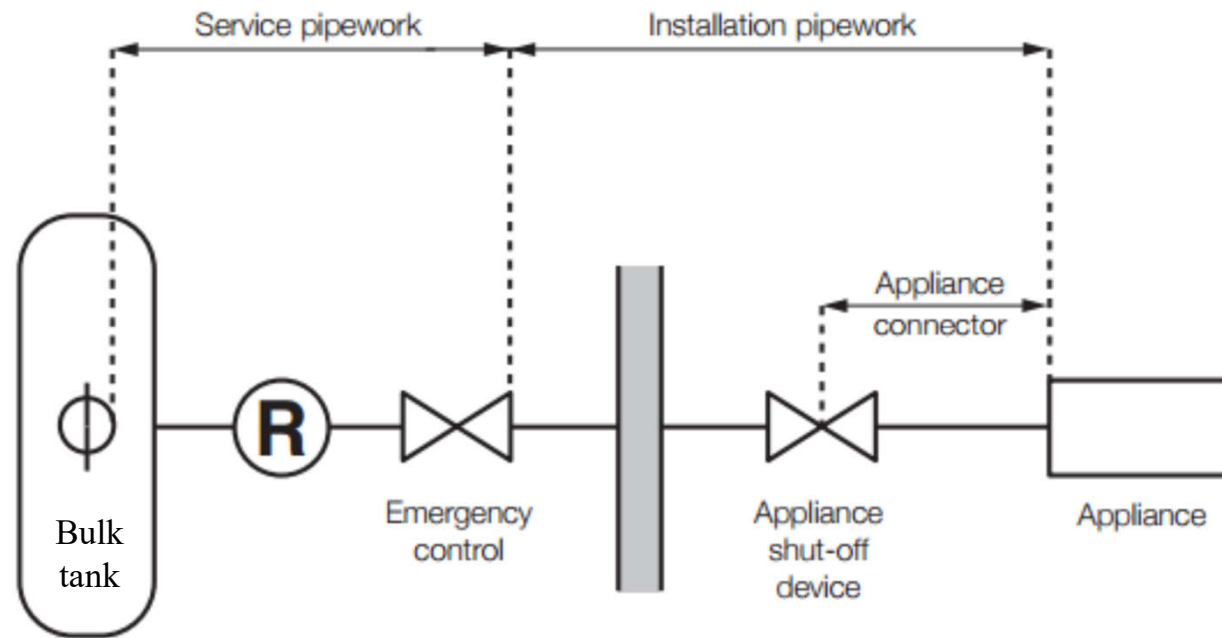

LPG system  
with manifold  
cylinder  
installation

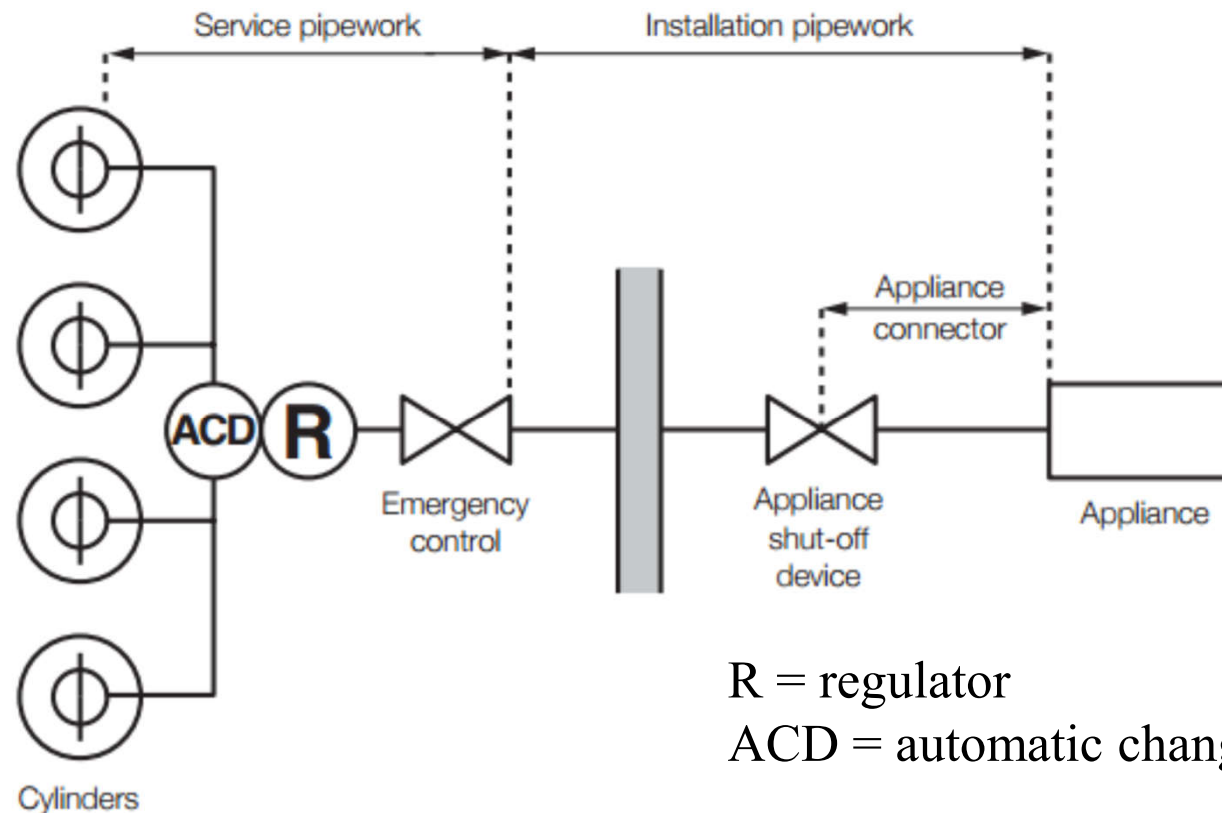

R = regulator

ACD = automatic change-over device

# LPG supply manifold system and minimum safety distances

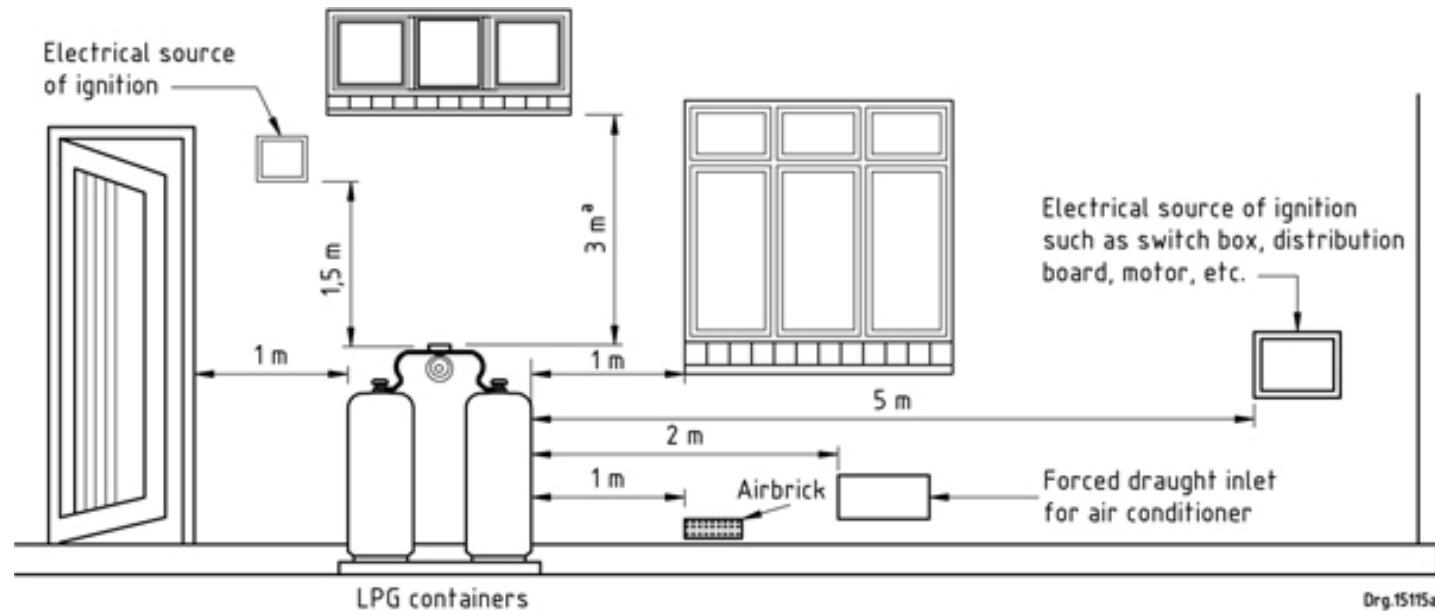
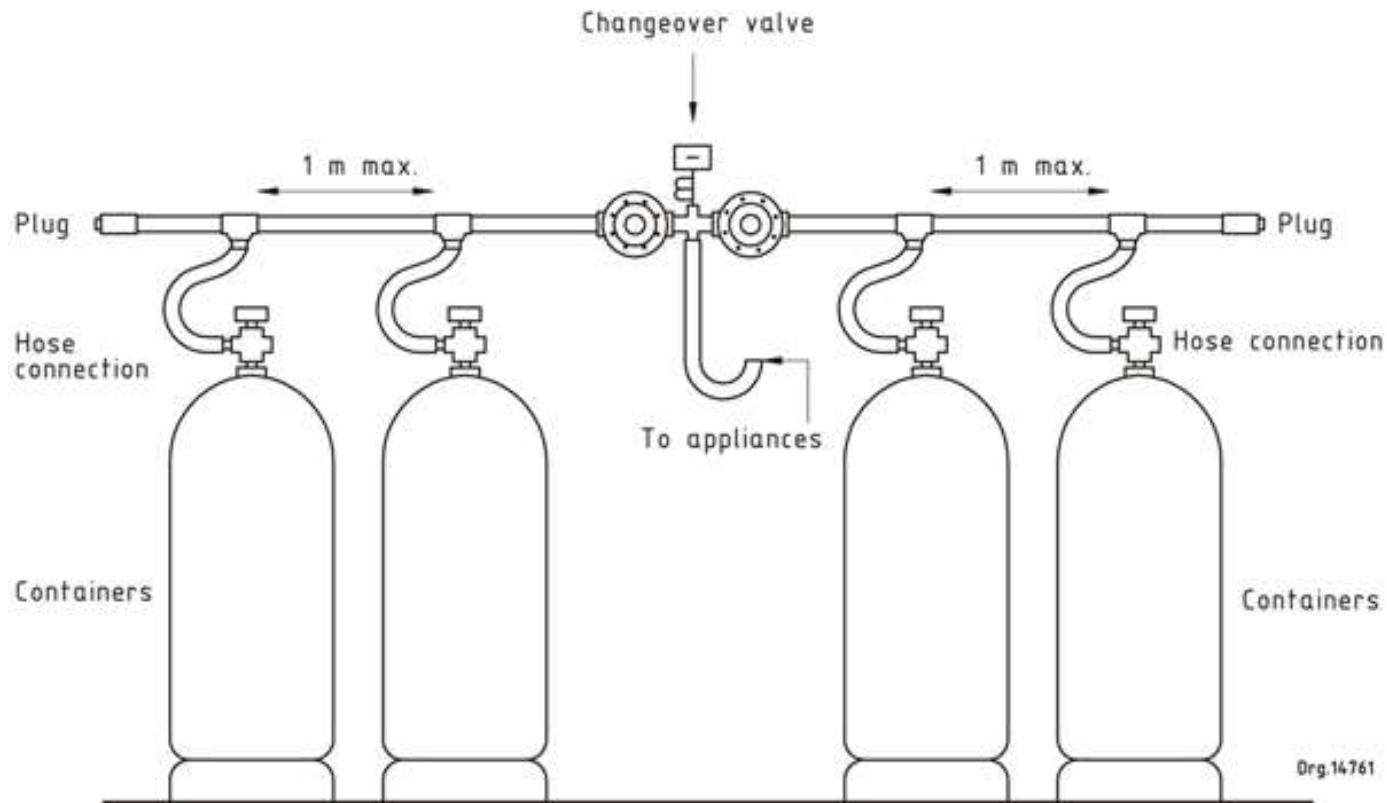



## Central LPG storage installation

# LPG filling stations and LPG vehicles in Hong Kong



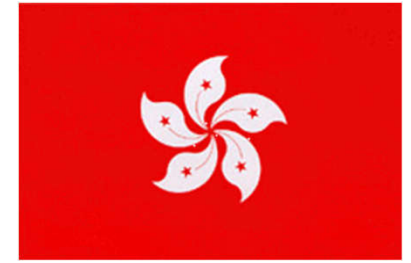

# Gas supply in Hong Kong

- Legislation, codes and guidelines in HK
  - Gas Safety Ordinance (Cap. 51)
  - Buildings Ordinance (Cap. 123)
  - Fire Services Ordinance (Cap. 95)
  - Codes of practice and guidance:
    - Related codes & guidance notes from EMSD
    - Related safety requirements in fire services codes
    - Technical guidelines from town gas company
  - Practice notes:
    - From Buildings Department and Planning Department

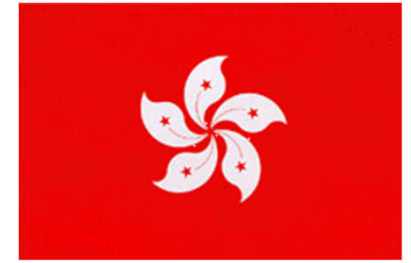

# Gas supply in Hong Kong

- Gas Authority in Hong Kong
  - Director of Electrical and Mechanical Services Department (EMSD)
    - Gas Standards Office of EMSD
- Registration schemes
  - Registered Gas Supply Companies
  - Registered Gas Contractors (RGC)
  - Registered Gas Installers (RGI)
- Competent Persons (professional)





表1:

氣體裝置工程的類別	
住宅類	第1類 安裝及測試接駁於一個石油氣瓶的平頭爐(即座檯爐)。
	第2類 在住宅房產內安裝氣體喉管(不包括測試)。
	第3類 在住宅房產內安裝及測試氣體喉管及住宅式氣體用具。
	第4類 安裝、測試及維修住宅式氣體用具。
商業類	第5類 在非住宅房產內安裝氣體喉管(不包括測試)。
	第6類 在非住宅房產內安裝及測試氣體喉管及非住宅式氣體用具。
	第7類 安裝、測試及維修非住宅式氣體用具。
工業類	第8類 安裝、測試及維修工業用的氣體用具。

Table 1:

Classes of Gas Installation Work	
Domestic	Class 1 Install and commission an LPG hotplate (i.e. table top cooker) supplied by one cylinder.
	Class 2 Install gas pipes in domestic premises (excluding commissioning).
	Class 3 Install and commission domestic gas appliances and gas pipes in domestic premises.
	Class 4 Install, commission and service domestic gas appliances.
Commercial	Class 5 Install gas pipes in non-domestic premises (excluding commissioning).
	Class 6 Install and commission non-domestic gas appliances and gas pipes in non-domestic premises.
	Class 7 Install, commission and service non-domestic gas appliances.
Industrial	Class 8 Install, commission and service gas appliances for industrial purpose.

### 建造業工人註冊證的「一證多用」新安排

由2017年11月起，建造業議會發出的建造業工人註冊證(註冊證)會按持證人的選擇標示持證人其他註冊資格的資料，包括《氣體安全條例》(第51章)訂明的氣體裝置技工的註冊資格。如持證人選擇標示這項註冊資格，則其註冊證便等同於現時機電工程署發給氣體裝置技工的註冊卡。

### New "Single-card-multiple-use" Arrangements for Construction Workers Registration Cards

Starting from November 2017, the Construction Workers Registration Cards (CWR Cards) issued by the Construction Industry Council (CIC) will show other registration qualifications of cardholders according to their preference, including the registration qualification of registered gas installers as stipulated in the Gas Safety Ordinance (Cap. 51). If a cardholder opts for showing this registration qualification, his CWR Card is equivalent to the registration card currently issued by EMSD to registered gas installers.



### 氣體安全監督 機電工程署

香港九龍啟成街3號  
Gas Authority  
Electrical and Mechanical Services Department  
3 Kai Shing Street, Kowloon Bay, Hong Kong  
電話 Tel : 1823 (熱線 Hotline)  
傳真 Fax : 2576 5945  
網頁 Website : www.emsd.gov.hk  
電郵 Email : info@emsd.gov.hk



 再造紙印製  
Printed on recycled paper



2018年3月  
March 2018

機電工程署  
EMSD 

(Source: [https://www.emsd.gov.hk/filemanager/en/content\\_284/gas\\_rgc.pdf](https://www.emsd.gov.hk/filemanager/en/content_284/gas_rgc.pdf))

## Classes of gas installation work

Domestic	Class 1: Installation, commissioning and routine maintenance of a domestic gas appliance which is a hotplate supplied by not more than one cylinder.
	Class 2: Installation of a service pipe, and any gas flow control, primary meter or primary meter installation used in connection with such pipe, in domestic premises; and an installation pipe in domestic premises.
	Class 3: Installation and commissioning of a service pipe, and any gas flow control, primary meter or primary meter installation used in connection with such pipe, in domestic premises; an installation pipe in domestic premises; and a domestic gas appliance.
	Class 4: Installation of domestic gas appliances to existing, adjacent gas supply points and commissioning and servicing of domestic gas appliances.
Commercial	Class 5: Installation of a service pipe, and any gas flow control, primary meter or primary meter installation used in connection with such pipe, in non-domestic premises; and an installation pipe in non-domestic premises.
	Class 6: Installation and commissioning of a service pipe, and any gas flow control, primary meter or primary meter installation used in connection with such pipe, in non-domestic premises; and an installation pipe in non-domestic premises; and a non-domestic gas appliance.
	Class 7: Installation of non-domestic gas appliances to existing, adjacent gas supply points and commissioning and servicing of non-domestic gas appliances.
Industrial	Class 8: Installation, commissioning and servicing of a gas appliance which forms part of an industrial process.

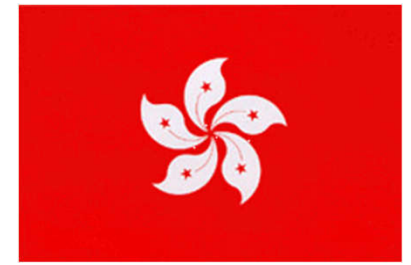

# Gas supply in Hong Kong

- Classes of Competent Person
  - 1. Testing & certification of LPG cylinders, tanks, vaporisers & mains
  - 2. Inspection & certification of LPG compounds & cylinder stores
  - 3. Examination & certification of gasholders
  - 4. Installation, commissioning and maintenance of LPG tanks, vaporisers, pipework, pressure regulators and associated equipment
  - 5. Installation, commissioning and maintenance of LPG pipework, pressure regulators and associated equipment
  - 6. Repair and maintenance of LPG vehicles

# System components

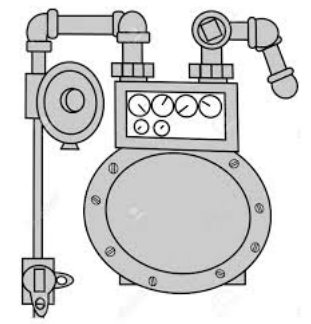

- Service pipe: the pipe between the gas main and the primary meter control (供氣分喉)
  - Usually polyethylene pipe is used underground and steel or copper pipe where it is exposed
  - The service pipe should enter the building on the side facing the gas main
    - Must not pass under the base of a wall of foundation
    - Must not be installed in an unventilated void space
    - Must not have electrical cables taped to it
    - Must not be near any heat source



# Gas supply to a house

What is this?

Gas main usually near the road

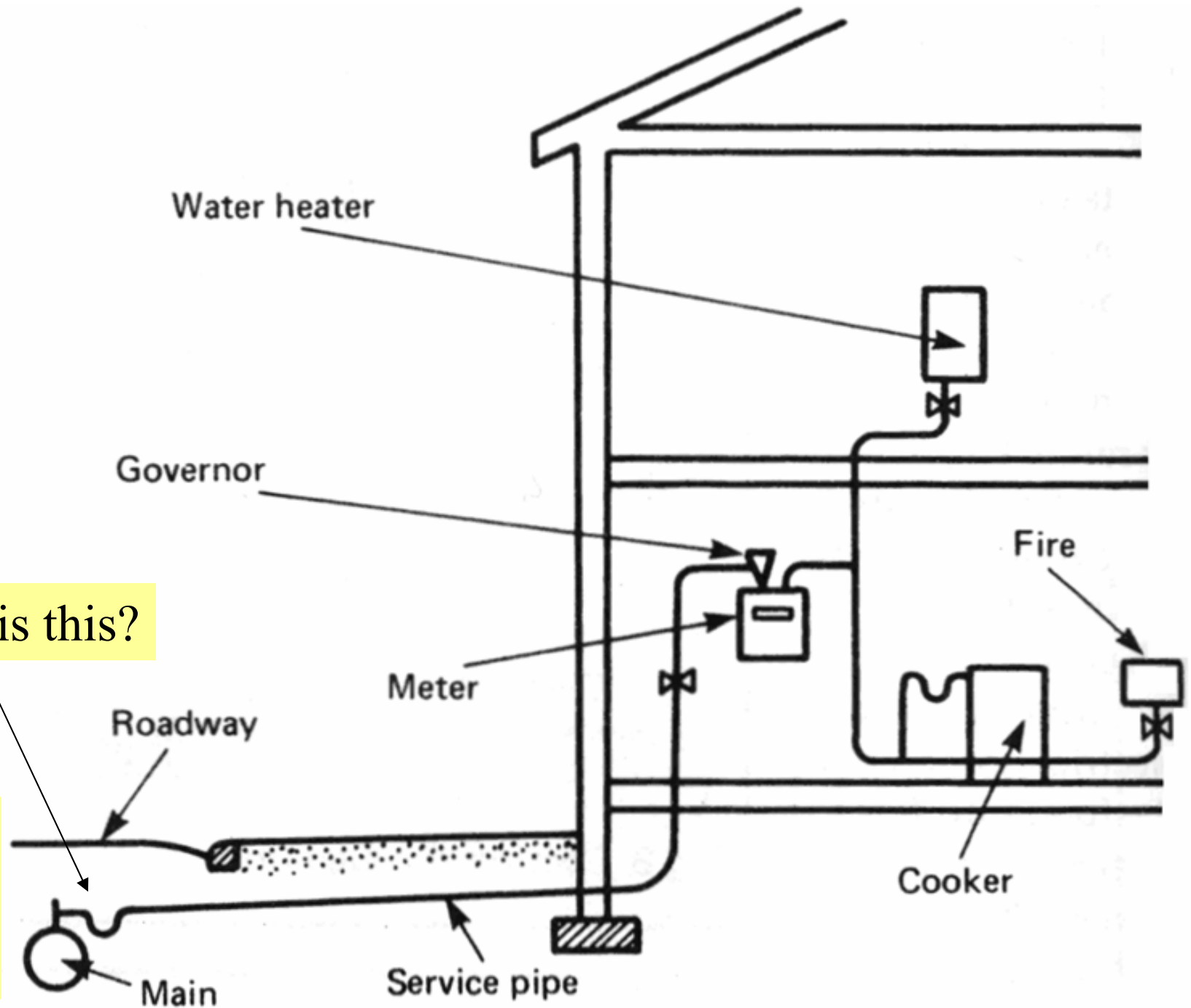

Where to put the gas pipe riser?

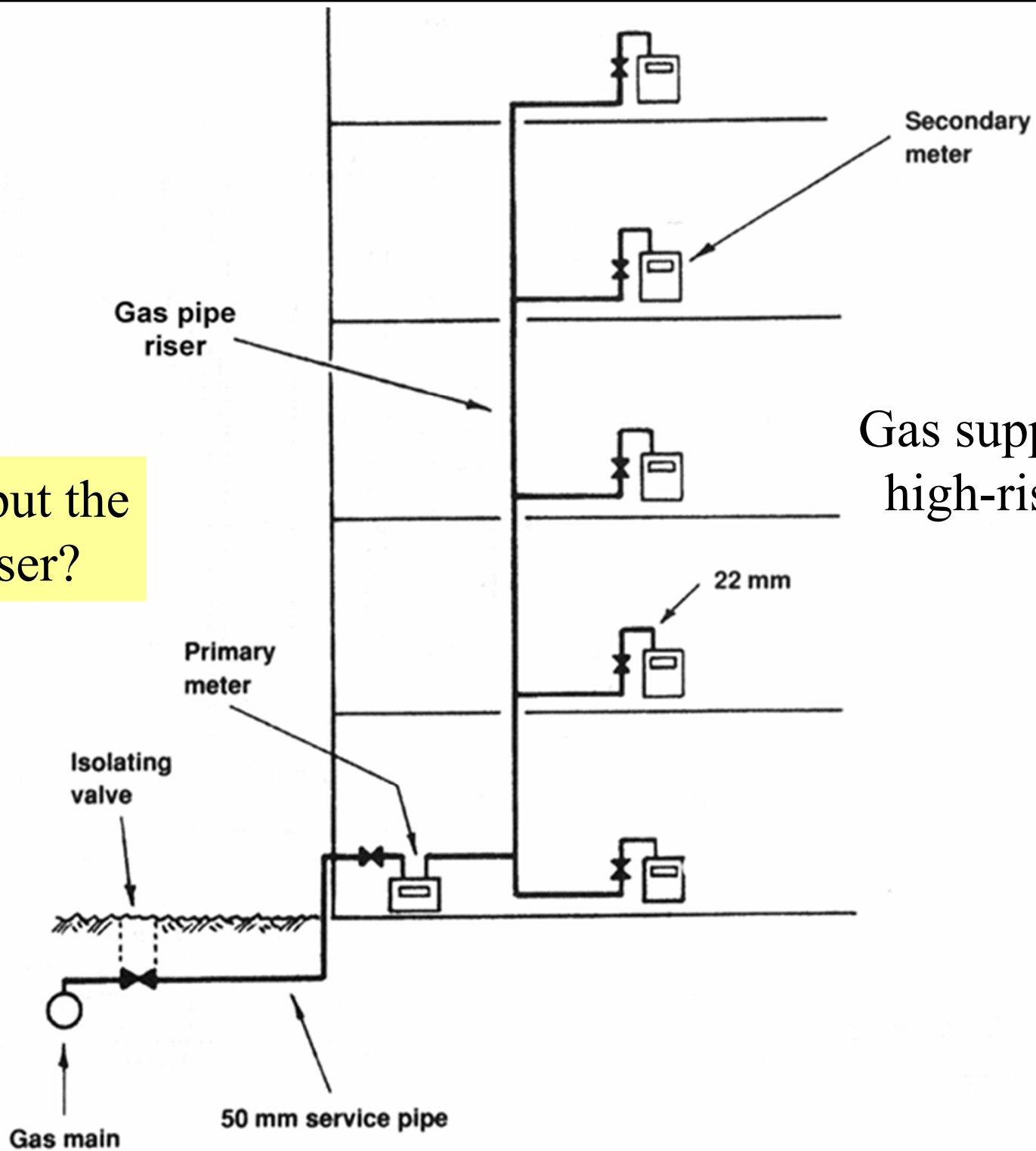

Gas supply to flats in high-rise buildings

# Gas service pipe risers installed in a shaft

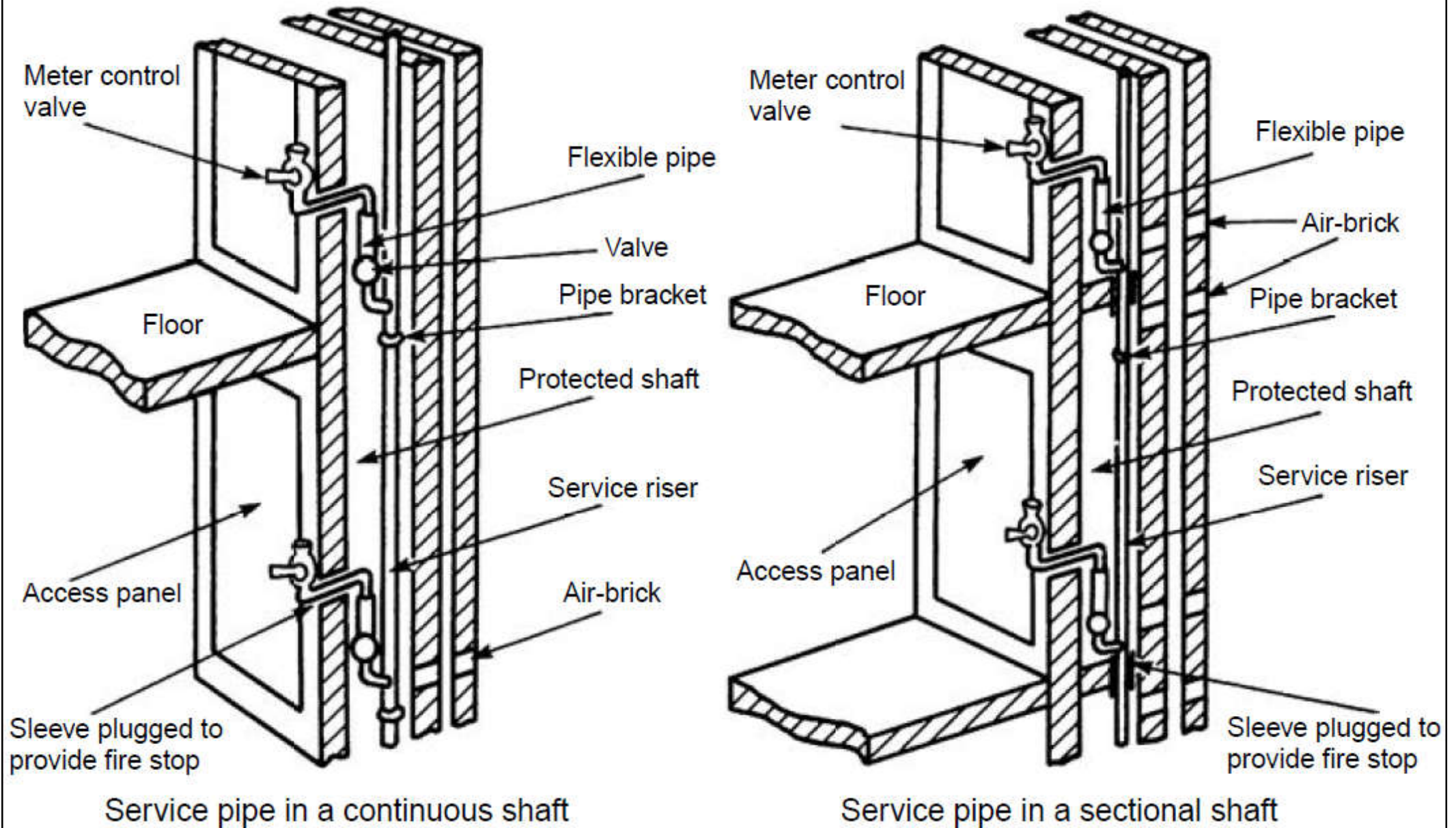

# System components

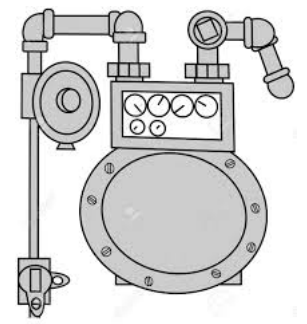

- Service riser: (上給供氣分喉)
  - Vertical service pipe and includes any horizontal sections of the service pipe between such vertical sections
  - Must be installed in open air space or fire-protected shafts
  - Ventilation to the outside air
  - Minimum fire resistance for shafts
  - Movement joints or flexible pipes and a service valve are provided at each branch



# Town gas service riser

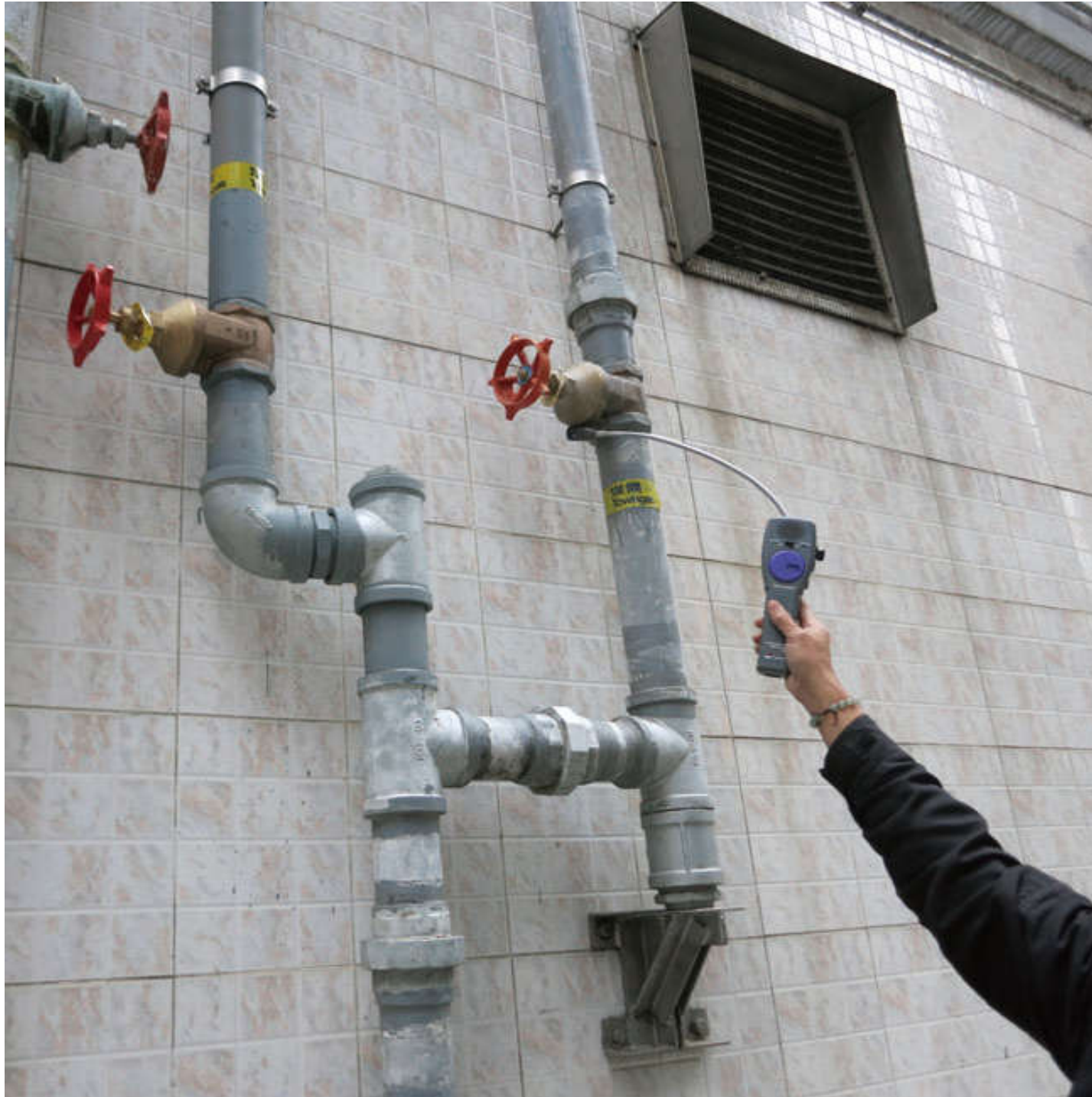

(Source: <https://www.emsd.gov.hk/gsp/en/b01.html>)

# LPG pipework inside and outside a building

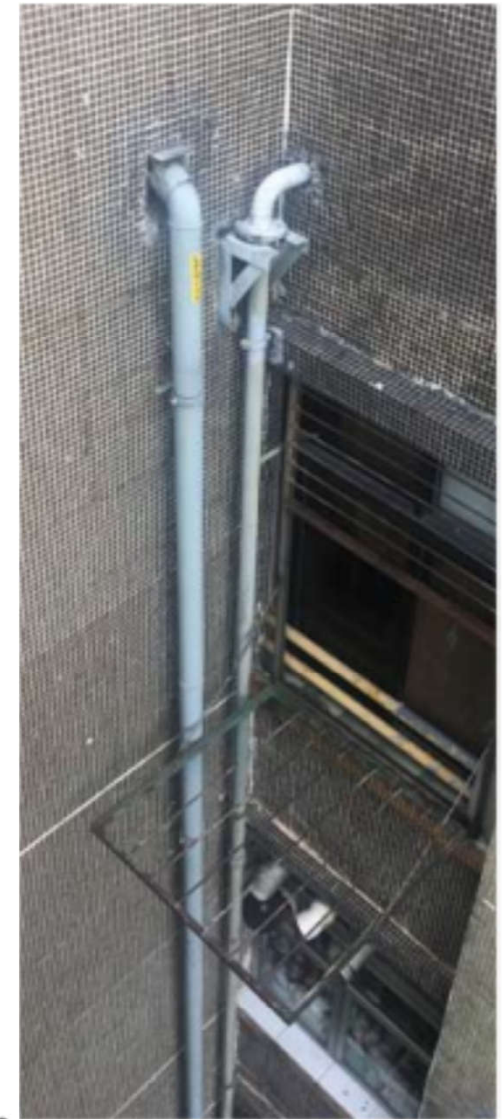
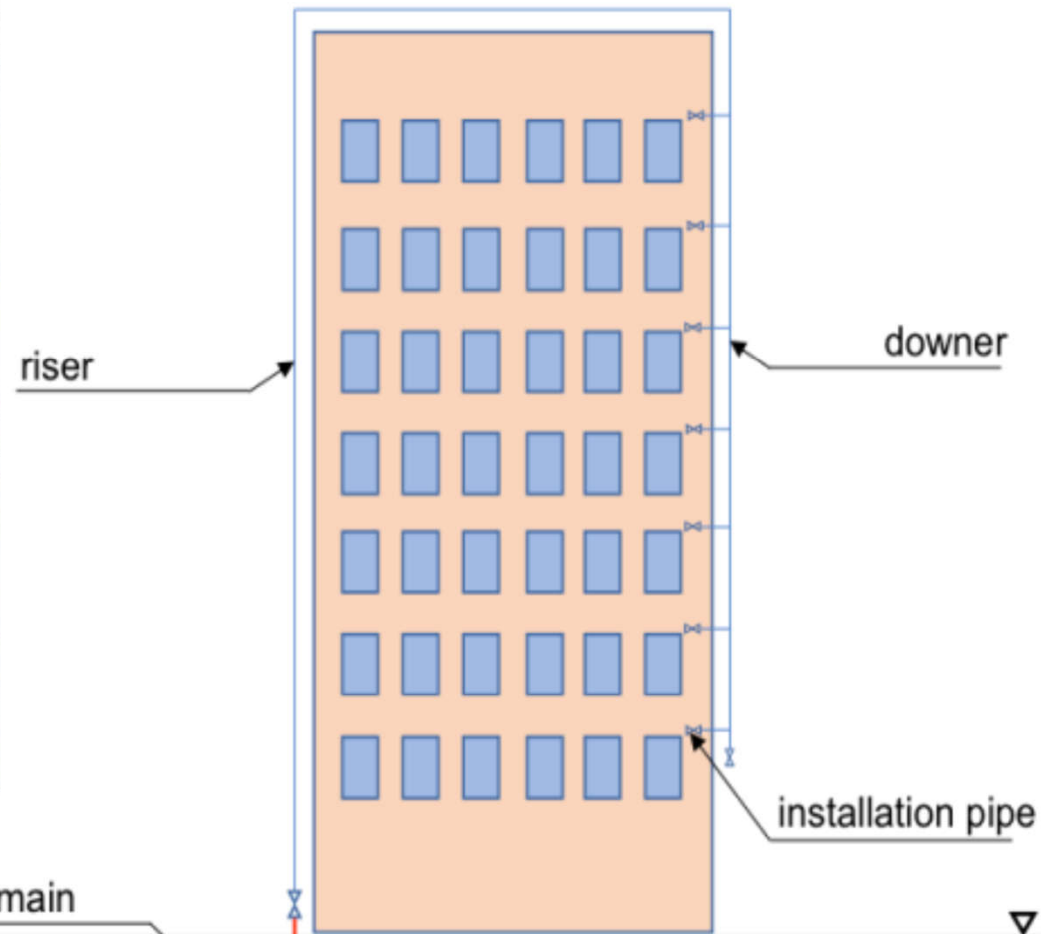

# System components

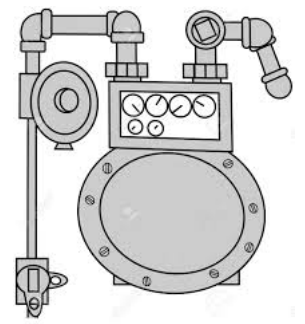

- Installation pipe: (用戶喉)
  - A pipe used to supply gas to a particular consumer, including any gas fitting used in connection with the pipe except a service pipe & a pipe comprised in a gas appliance
  - A service riser & an installation pipe should be inspected & maintained every 18 months to ensure that the gas pipes are in good condition



# System components

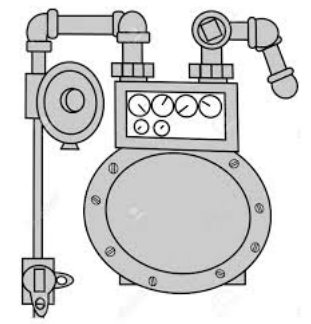

- Gas Meters (氣體錶)
  - Must be sited conveniently for access
  - Meters remain the property of gas company
  - Components:
    - Main control cock
    - Pressure governor
    - A bypass pipe (for large/industrial installation)
    - Test points
    - Earth bonding (for electrical safety)
  - Types: domestic, industrial & smart meters



# Domestic gas meter

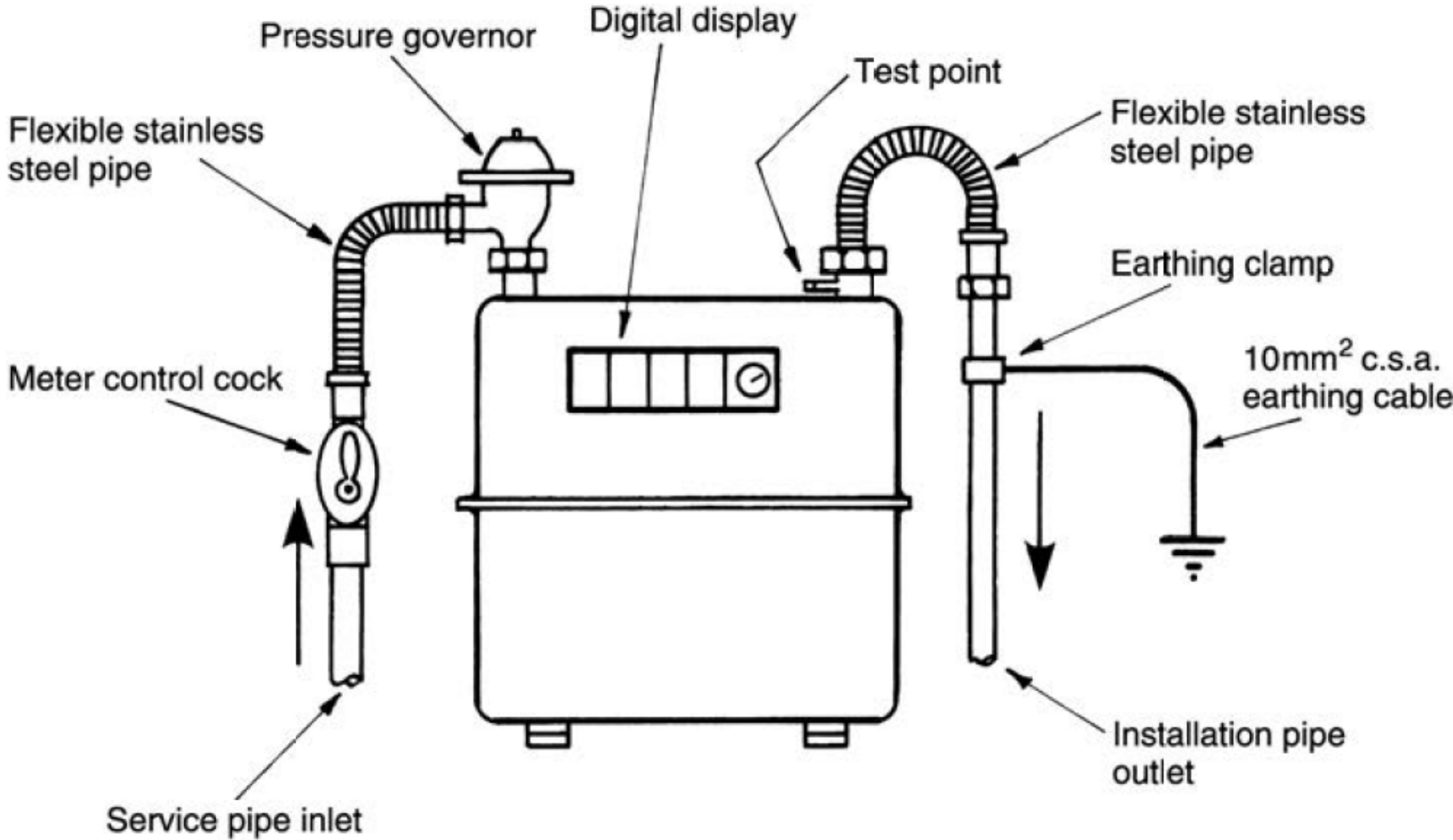

Check this at your home!

(Source: Hall, F. and Greeno, R., 2013. *Building Services Handbook*)

# Components for gas controls

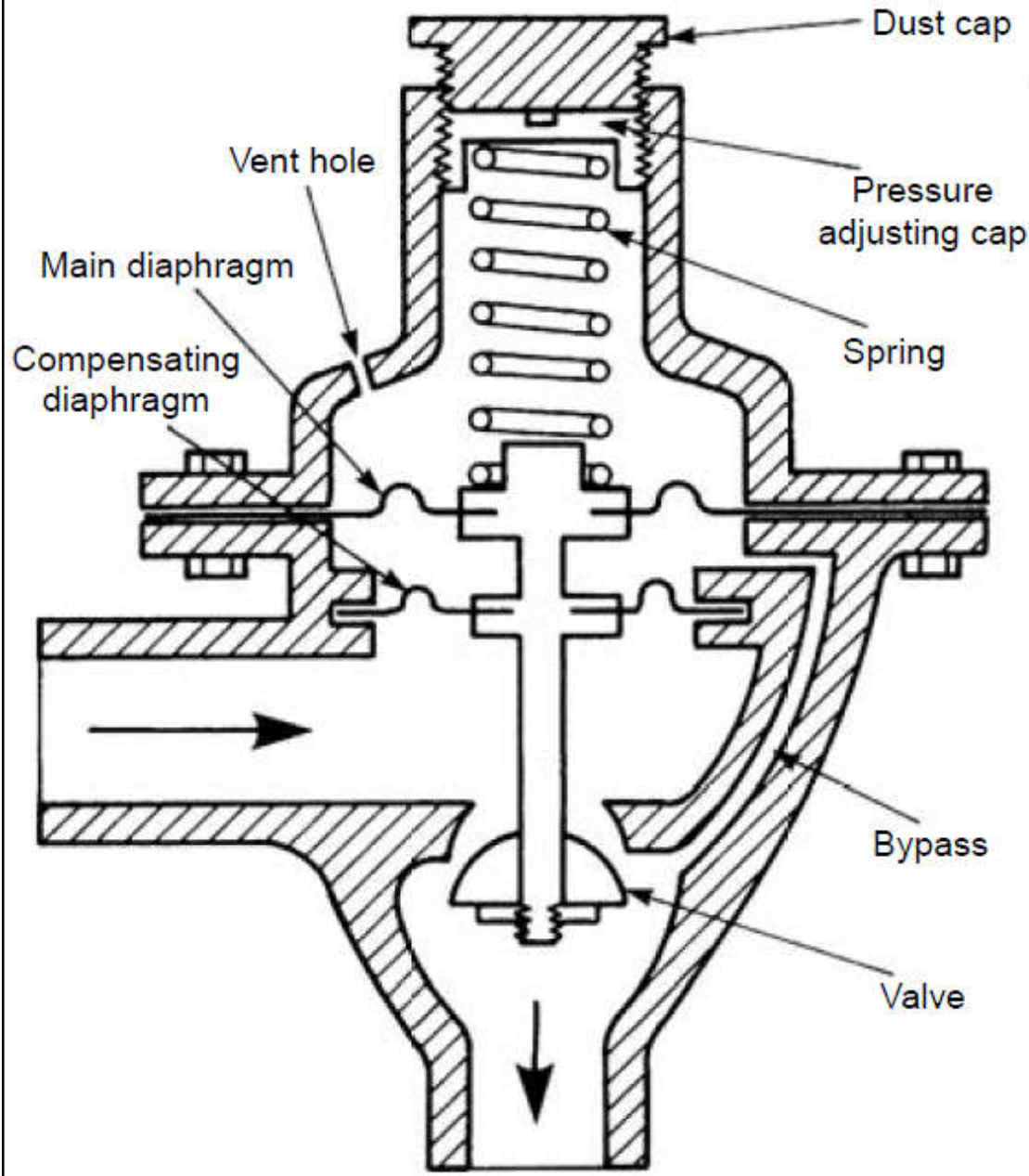

Constant pressure governor

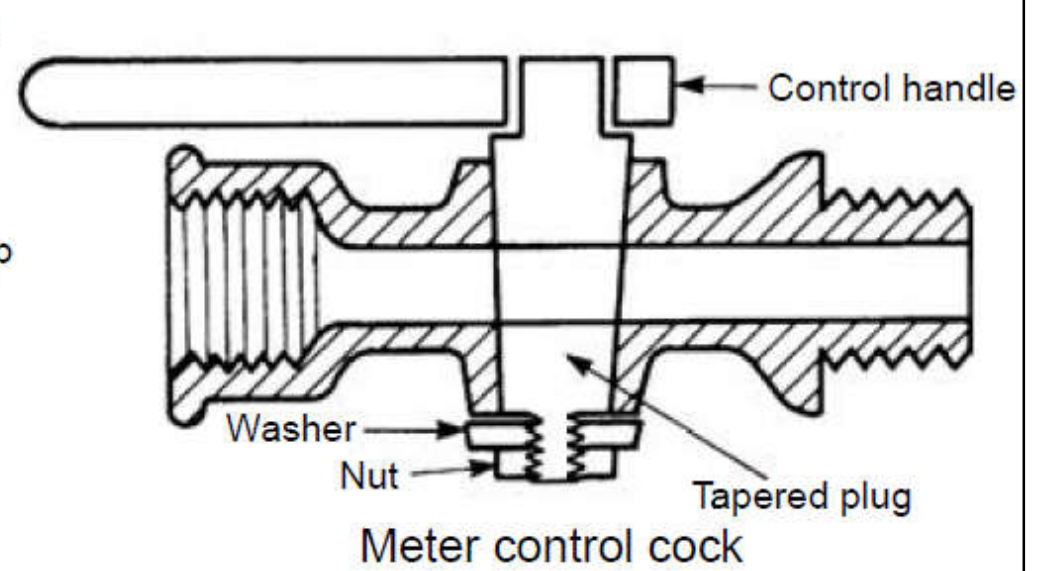

Meter control cock

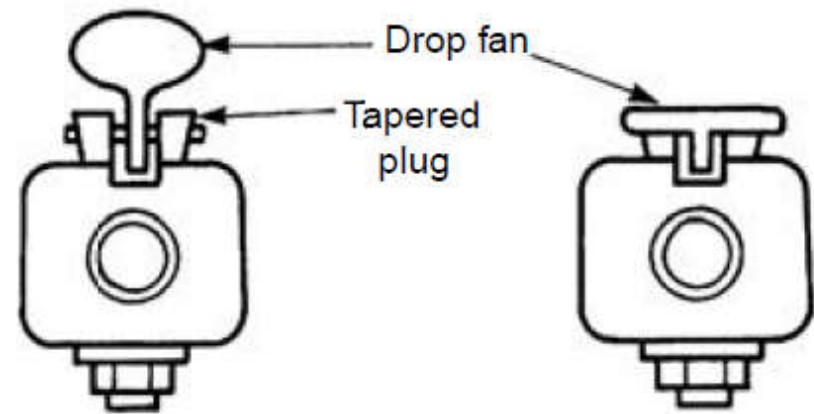

Drop-fan safety cock

# Industrial gas meter

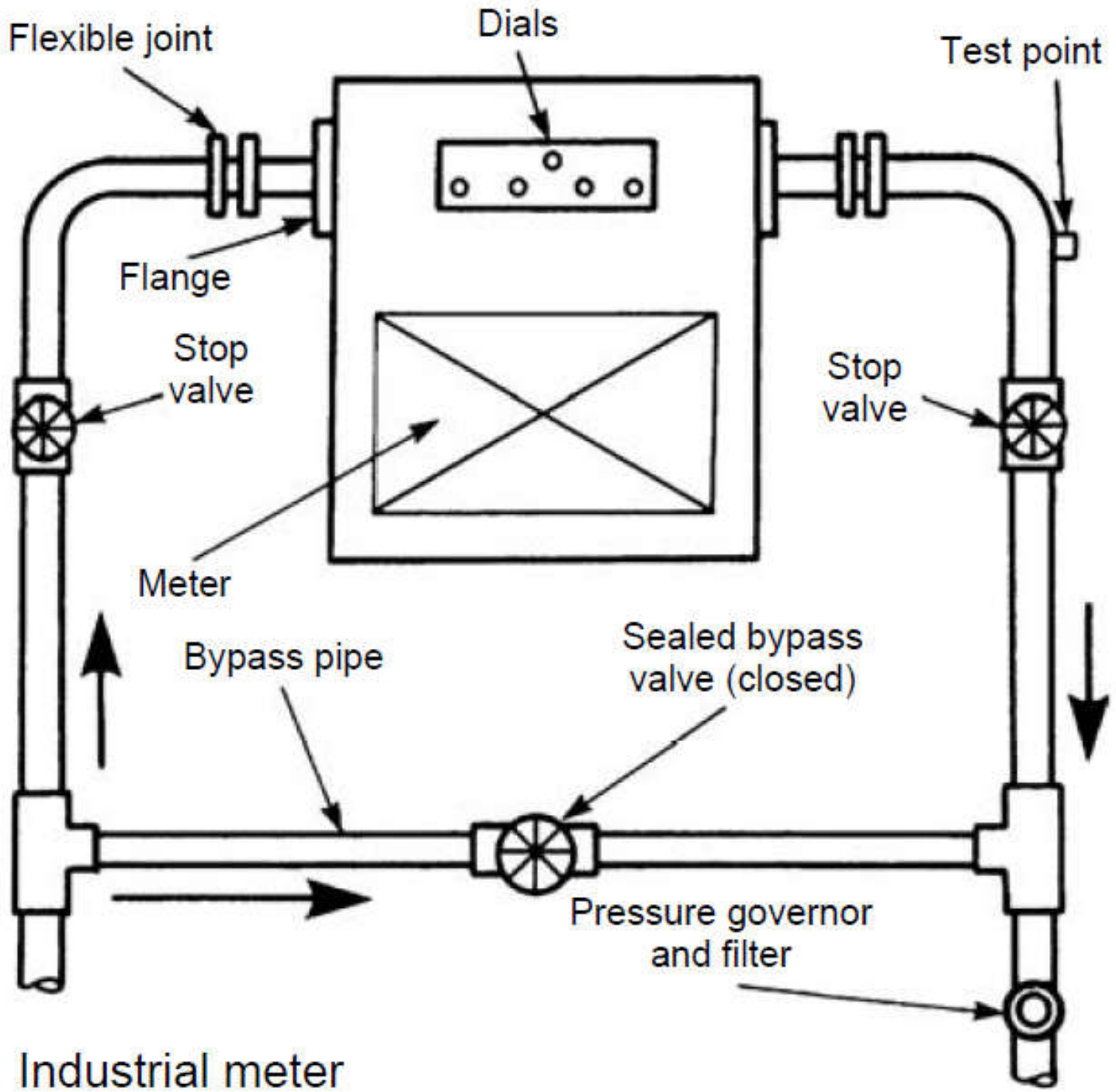

What are the main differences with the domestic one?

Industrial meter

(Source: Hall, F. and Greeno, R., 2013. *Building Services Handbook*)

# System architecture of automatic meter reading (AMR) of Towngas

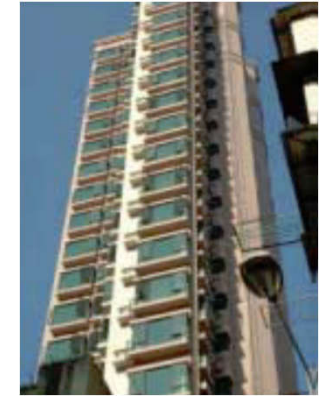
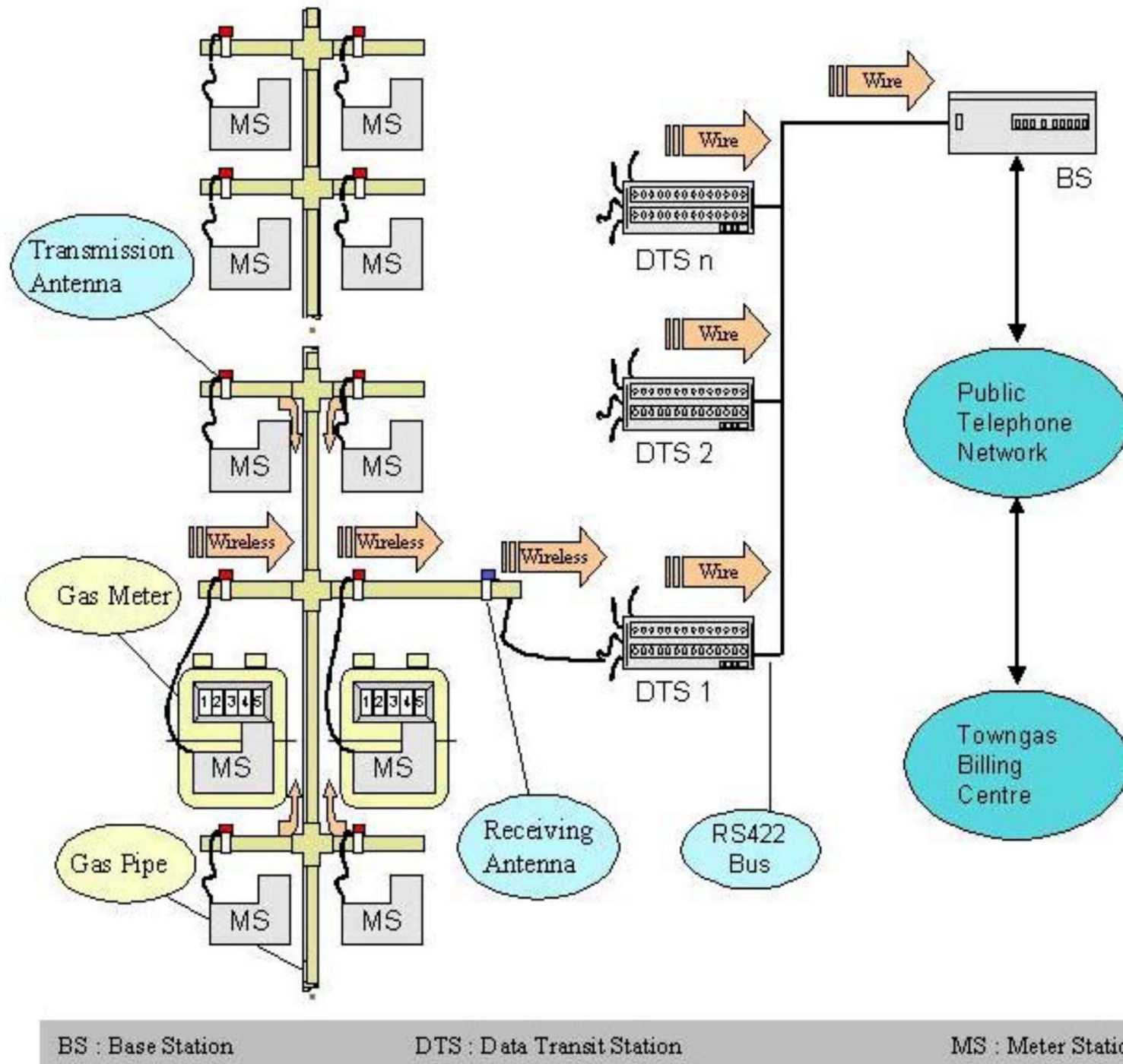



# System components

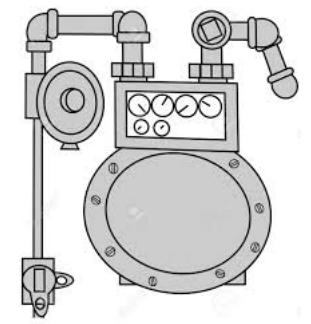

- Emergency Control Valve

- Installed as near, so far as practicable to the point of gas service entry into the premises in an accessible location

- Fire Safety Valve

- A gas isolation valve located external to the kitchen area for use by Fire Services Officers in an emergency

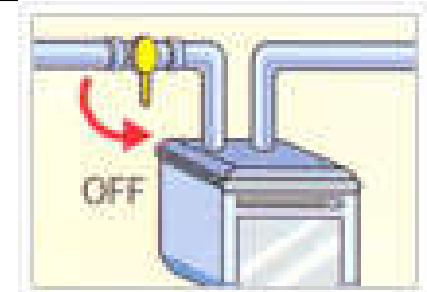

- Gas Appliances, e.g. burners, water heaters

# Low pressure flexible gas tubing for connection to gas appliances



Type 1: Tubing made of rubber with 3 years service life

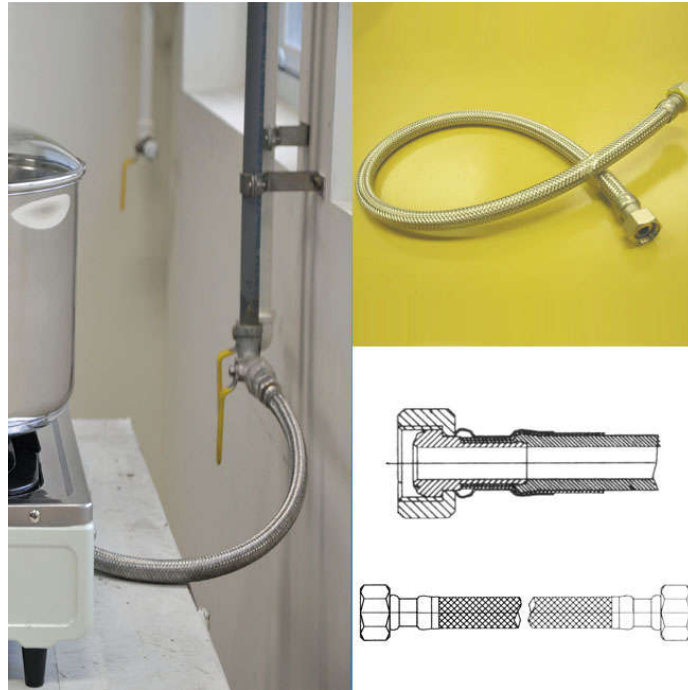

Type 2: Tubing made of rubber with stainless steel braiding or armouring with 3 or 10 years service life

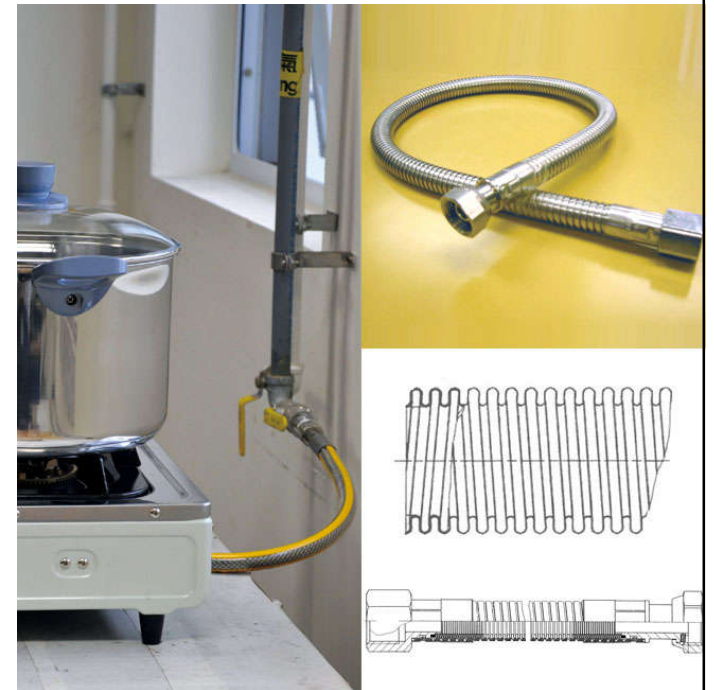

Type 3: Tubing made of stainless steel with unlimited service life



# Major parts of a gas installation and gas controls

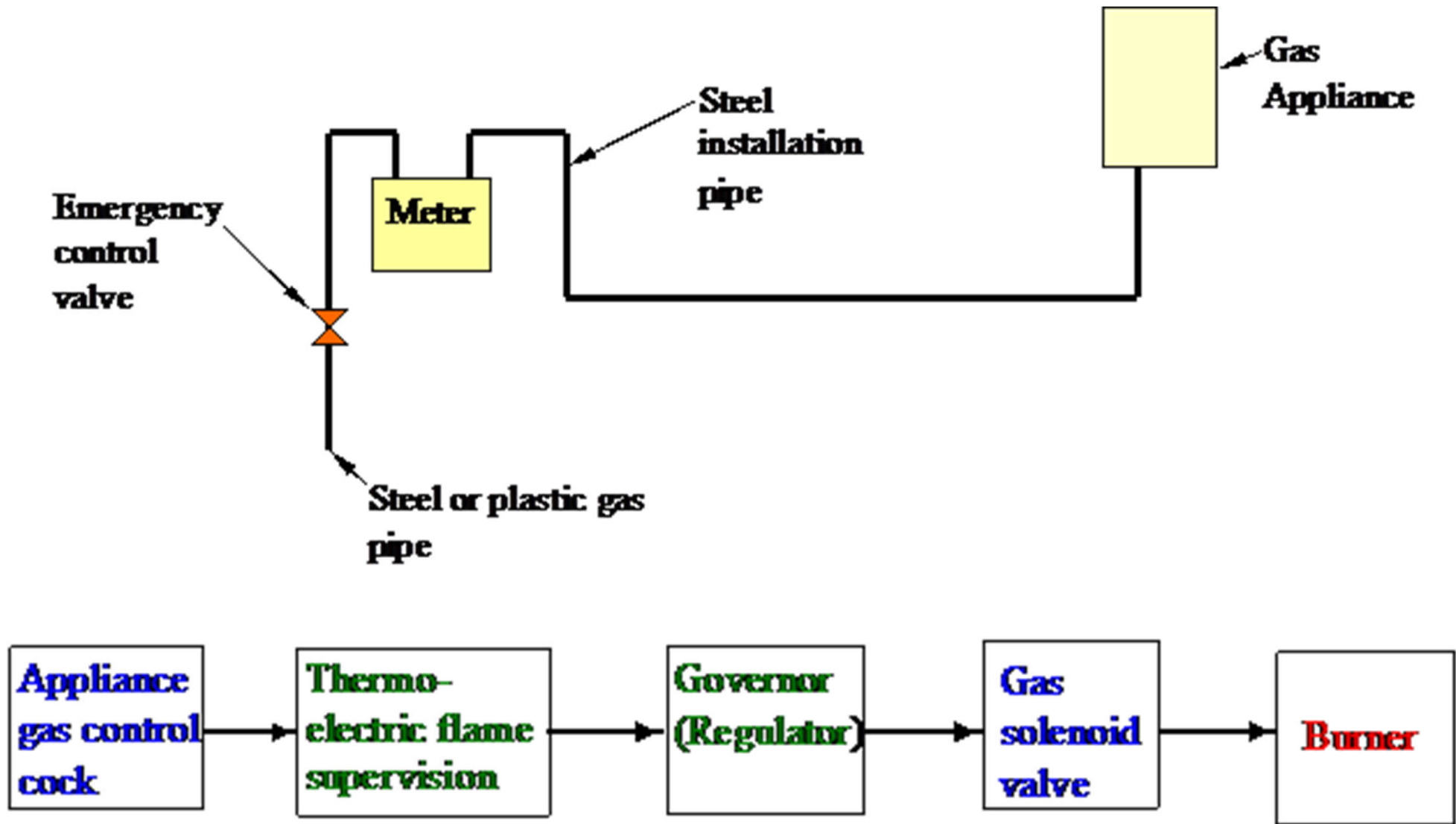

**BLOCK DIAGRAM OF GAS CONTROLS TO APPLIANCE**

# Flame failure safety devices

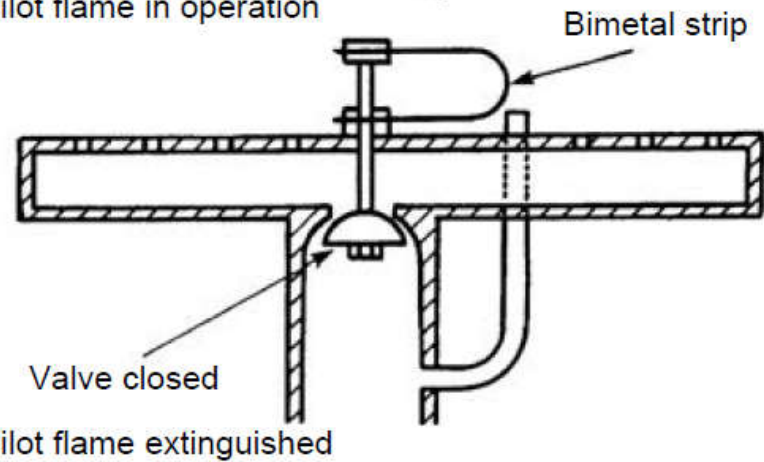
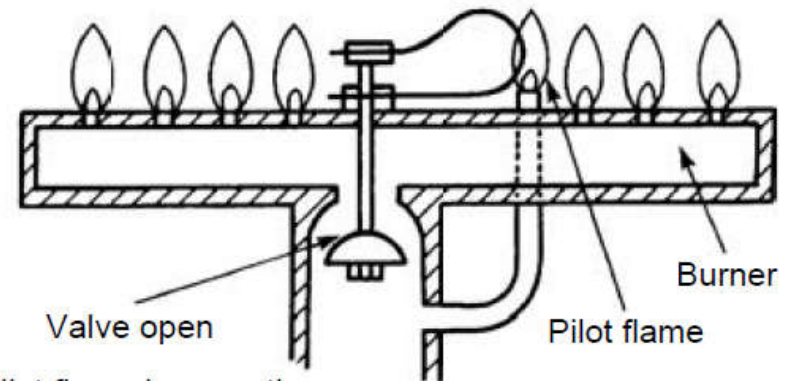
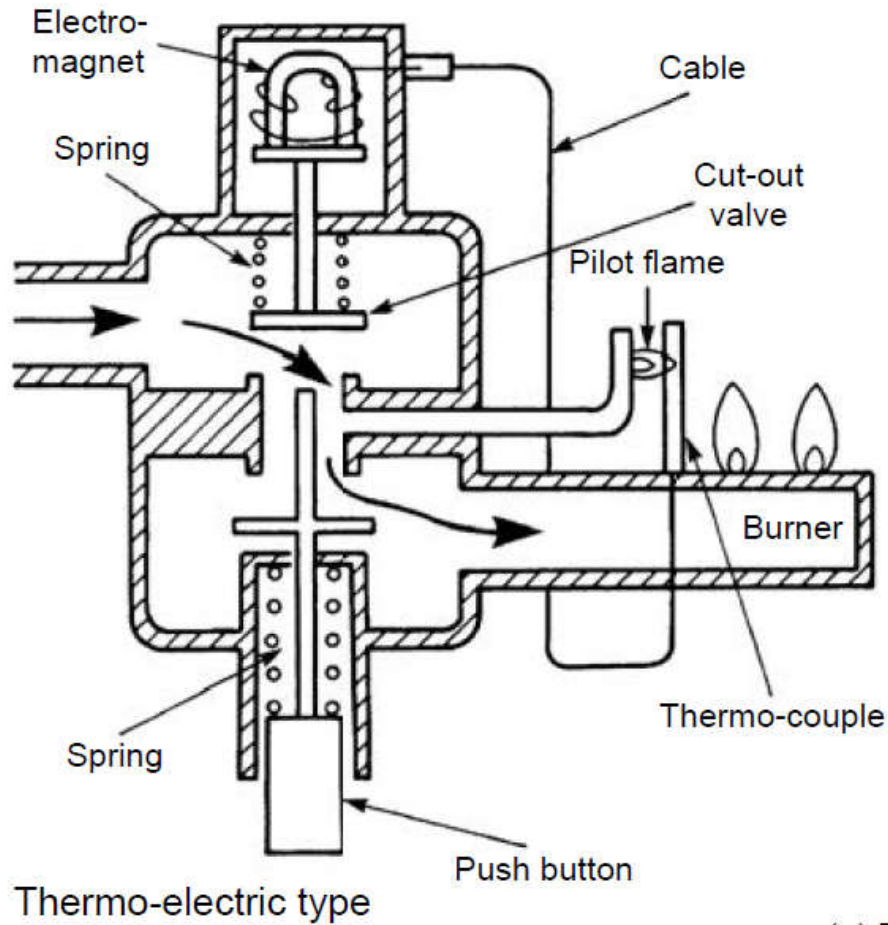

# Gas ignition devices

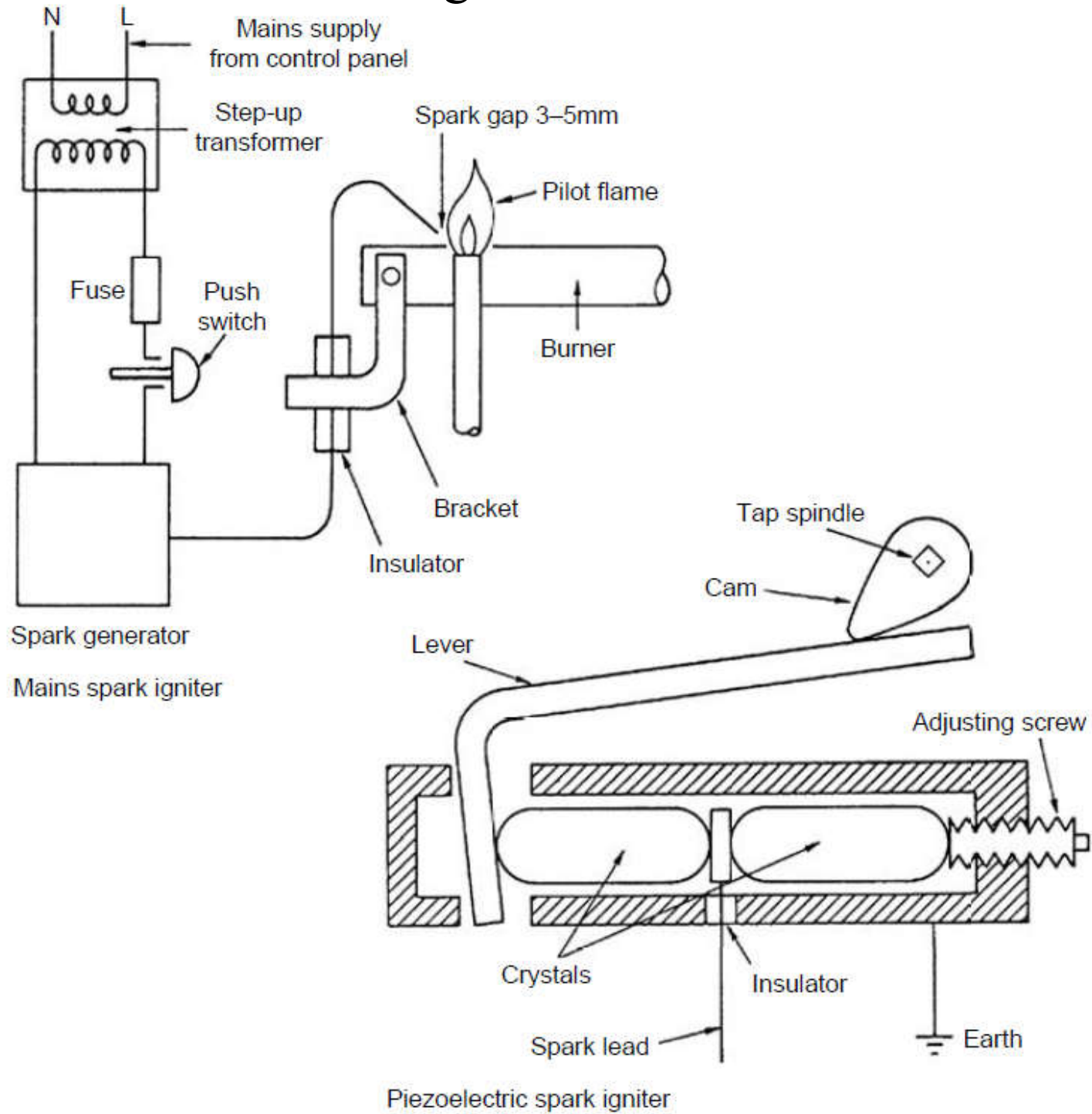

# Gas installations in commercial premises



Control valve & meter



Water heater



Kitchen appliances

# Laundry equipment using LPG system

兩者盡可能遠離  
As far as applicable

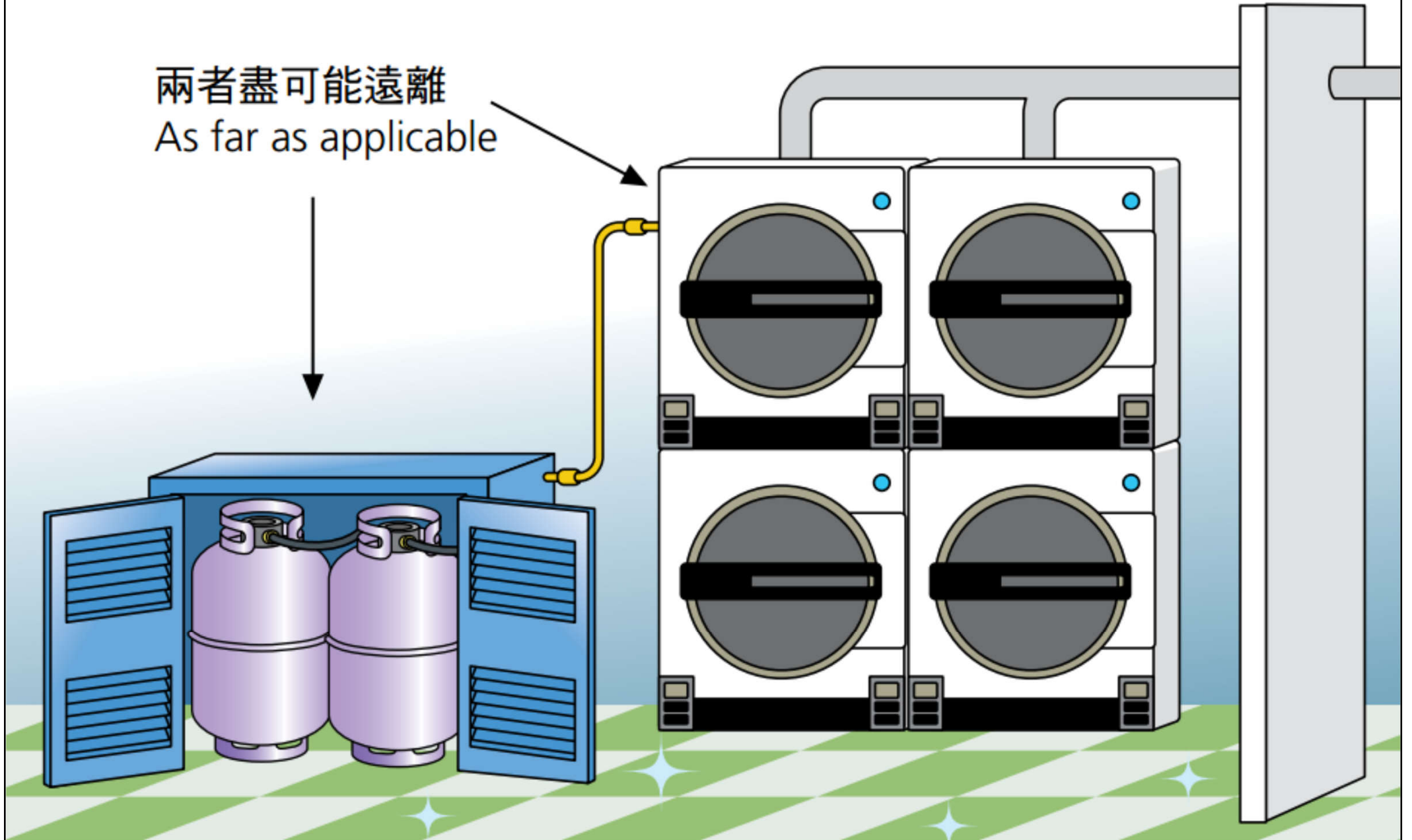

## 購買已批准的 住宅式氣體用具

### PURCHASE THE APPROVED DOMESTIC GAS APPLIANCES



新規例  
New Regulations



#### 在新規例下，我應該注意甚麼？

##### What areas of the new Regulations should I pay attention?

為安全起見，切勿攜帶入境或進口未經批准的住宅式氣體用具，此舉可能觸犯法例。

For safety reasons, do not bring in or import non-approved domestic gas appliances. Doing so may commit an offence.

#### 除新規例外，有否其他應注意的安全事項？

##### Apart from the new Regulations, what other safety concerns should be addressed?

所有氣體用具安裝和更換工程，現行規例訂明須由註冊氣體工程承辦商僱用的註冊氣體裝置技工進行。此外，應該每年最少一次為氣體用具檢查/維修，以保持良好操作狀態。

All installation and replacement work shall be carried out by registered gas installers employed by registered gas contractors as required by existing regulations. You should arrange to conduct check/service for your gas appliances at least once a year to ensure their good working order.

#### 違反新規例會否被罰？

##### Any penalties for non-compliance?

新規例說明任何人如不遵守有關進口、在香港生產、售賣及供應住宅式氣體用具供在香港使用的規定，一經首次裁定犯法，最高刑罰為第六級罰款（10萬元）及監禁一年。

Any person who fails to comply with regulatory requirements relating to the importation, manufacture in Hong Kong, sale and supply of domestic gas appliances for use in Hong Kong will be liable on first conviction to a maximum fine at level 6 (\$100,000) and one-year imprisonment.

#### 有哪些查詢途徑？

##### Any means of making enquiry?

若需要有關新規例詳情，可致電機電工程署熱線或瀏覽網頁：

For details of new Regulations, please call the hotline or browse EMSD web-page:

2882 8011

<http://www.emsd.gov.hk>

氣體供應公司熱線：

Hotlines of gas supply companies:

煤氣	Towngas	2880 6988
華潤	China Resources	2433 2111
殼牌	Shell	2435 8388
埃索美孚	Exxon Mobil	3197 8680
加德士	Caltex	2802 8338
協和	Concord	2333 4215





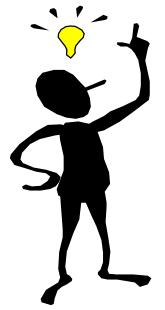

# Design considerations

- Hazard assessments for gas works are needed for project evaluation to minimize the risk and identify additional safety measures
- Assessment of gas load:
  - Diversity
  - Flow equation and calculation
  - Pressure loss due to pipe components
  - Effect of altitude (if any)
- Access and security



# Example of gas network layout for industrial or commercial connection

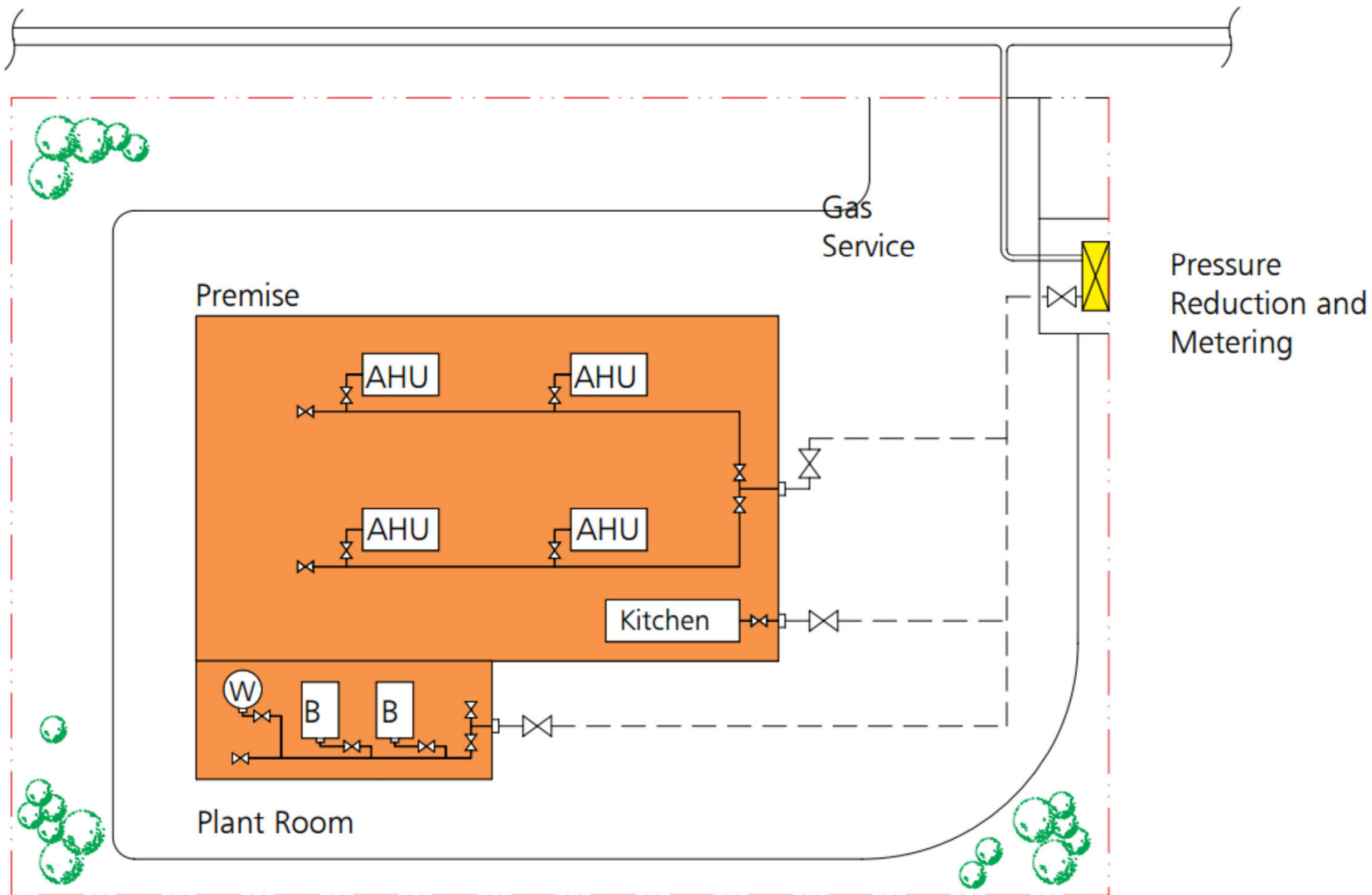

B - Boiler

W - Water Heater

AHU - Air Handling Unit

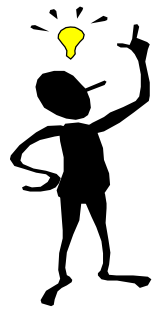

# Design considerations

- Planning of network pipelines
  - Above-ground or below-ground entry
  - External or internal pipelines
  - Gas pipes must have fall & drain points
  - Underground buried pipes protected by bitumen or 'denso' tape (to prevent leakage & corrosion)
  - Naturally ventilated spaces is preferred
  - Early detection of leakage + electrical safety
  - Gas company should be consulted

# Design considerations

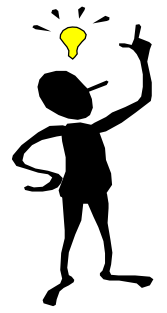

- Meters and isolation valves



- Meter installations (location, individual or banks)
- Isolation valves (inlet, branch, emergency)
  - Provision for testing & commissioning

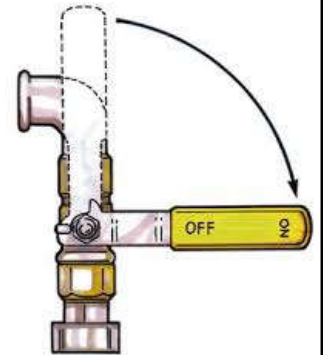

- Purging new gas installations

- New installations are thoroughly purged of air and debris that may remain in the completed pipework
- If air is not removed, it is possible that when attempting to ignite the gas, a gas-air mixture will cause a blow-back and an explosion

# Design considerations



- Flues

- Low-level flue gas discharge
  - Much simpler than solid fuel or oil
- Sufficient dilution with fresh air
  - Manage the heat and air pollution
- Small gas appliances/cookers: indoor discharge
- Water vapour in discharge
- Vitreous clay & asbestos cement pipes
- Balanced flue gas water heater

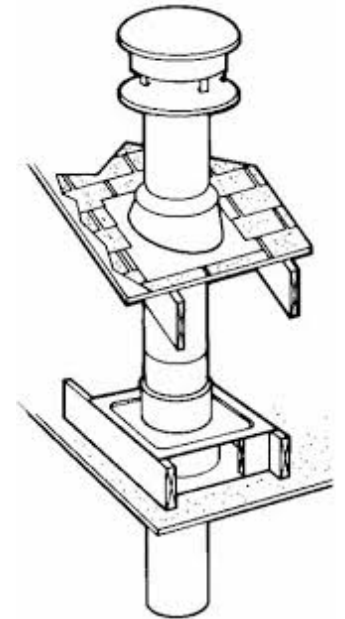

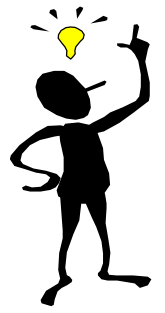

# Design considerations

- Types of gas water heaters:
  - **Balanced flue**
    - A room-sealed gas water heater incorporating an air-inlet-cum-product-outlet terminal designed to be exposed on an external wall
  - **Fanned draught**
    - A flue system in which the draught is produced by a fan
  - **Open-flued**
    - Connected to a flue system, its combustion air being drawn from the room or internal space in which it is installed
  - **Room-sealed**
    - When in operation, has the combustion air inlet and the combustion products outlet isolated from the room in which the heater is installed



## 禁止使用無煙道式氣體熱水爐以供浴室或淋浴使用

Prohibition of Flueless Gas Water Heaters Used to Serve a Bathroom or Shower



機電工程署  
Electrical & Mechanical  
Services Department

### 1. 不合規格的無煙道式氣體熱水爐裝置

#### Substandard Flueless Gas Water Heater Installations

無煙道式氣體熱水爐供浴室或淋浴用途屬於危險的裝置，因為該熱水爐會從室內抽取供燃燒用之空氣，而燃燒後之廢氣(包括有毒的一氧化碳)會直接帶進裝有這類熱水爐的房間內，如在通風不足下可能積聚至危險水平。

Flueless gas water heaters serving bathrooms or showers are considered dangerous because they consume the air inside the room and the products of combustion containing toxic carbon monoxide discharge directly into the room where the heater is situated, and may build up to dangerous levels if ventilation is inadequate.

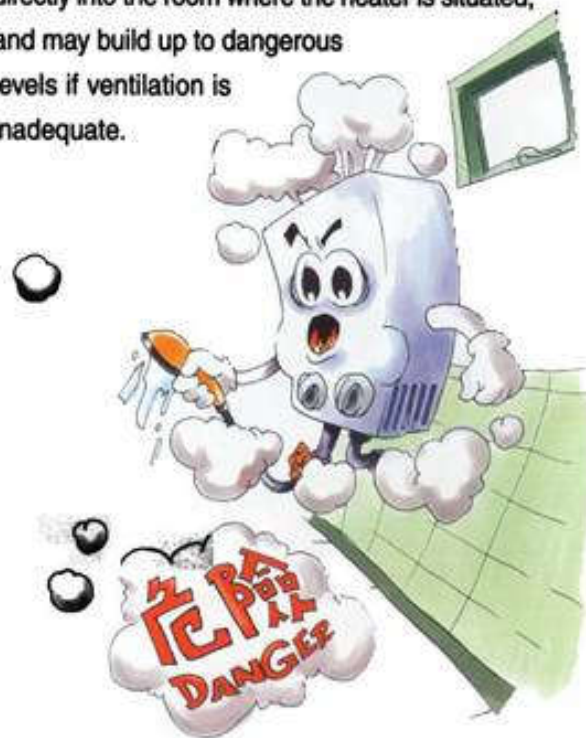

### 2. 禁止使用無煙道式氣體熱水爐以供浴室或淋浴用途

#### Prohibit Use of Flueless Gas Water Heaters Supplying Bathroom or Shower

為防止不適當使用無煙道式氣體熱水爐而引致危險，立法局於1999年11月通過氣體安全規例修訂，禁止使用無煙道式氣體熱水爐以供浴室或淋浴用途。該項修訂將於**2000年4月1日**正式實施。此外，新規例亦禁止任何人供應或安裝新的無煙道式熱水爐，或以其他無煙道式型號替換現時無煙道式氣體熱水爐。

In order to eliminate dangers from improper use of flueless gas water heaters, LEGCO passed an Amendment of the Gas Safety Regulations in November 1999, which prohibits the use of a flueless gas water heater to serve a bathroom or shower. The Amendment will come into effect on **1 April 2000**. In addition, the new law also prohibits anyone from supplying or installing a new flueless gas water heater or replacing an existing flueless gas water heater by another flueless model.

### 3. 氣體安全規例修訂內容 Details of Amendment to Gas Safety Regulations

修訂主要分為二部份，第一，〈氣體安全(裝置及使用)規例〉修訂確立自**2000年7月1日**開始任何人不得將無煙道式氣體熱水爐供浴室或淋浴間使用。

## 住宅式氣體用具 之安全 Domestic Gas Appliance Safety



這一系列的單張，是把氣體燃料安全的一些要點加以說明，這些要點是各位使用石油氣及煤氣的住宅用戶應該知道的。

*This series of leaflets cover some important aspects of gas safety which the domestic consumers should know about when using LPG (liquefied petroleum gas) and Towngas.*

### 住宅式氣體用具之安全

#### 1. 我應選擇那種住宅式即熱氣體熱水爐？

答：密封式熱水爐（通常是對衡式）是新安裝及更換熱水爐時的最佳選擇。這種熱水爐會從戶外直接抽取供燃燒用之新鮮空氣，而燃燒後之廢氣亦會直接排出戶外（即室內密封式），因此，熱水爐不會消耗或污染室內的空氣。如樓宇內已預留合適的煙道牆孔，以備安裝密封式氣體熱水爐供浴室使用，用戶在該樓宇內安裝任何其他種類的氣體熱水爐，即屬違例。密封式熱水爐備有多種型號，其中包括機動排煙式型號，以供選擇。這種熱水爐在大多數情況下均易於安裝。



### Domestic Gas Appliance Safety

#### 1. What type of domestic instantaneous gas water heater should I choose ?

*Ans: Room-sealed (balanced-flue) gas water heaters are the first choice for new and replacement installations. Fresh air for combustion and combustion products are taken from*





# Balanced flue gas-fired instantaneous water heater

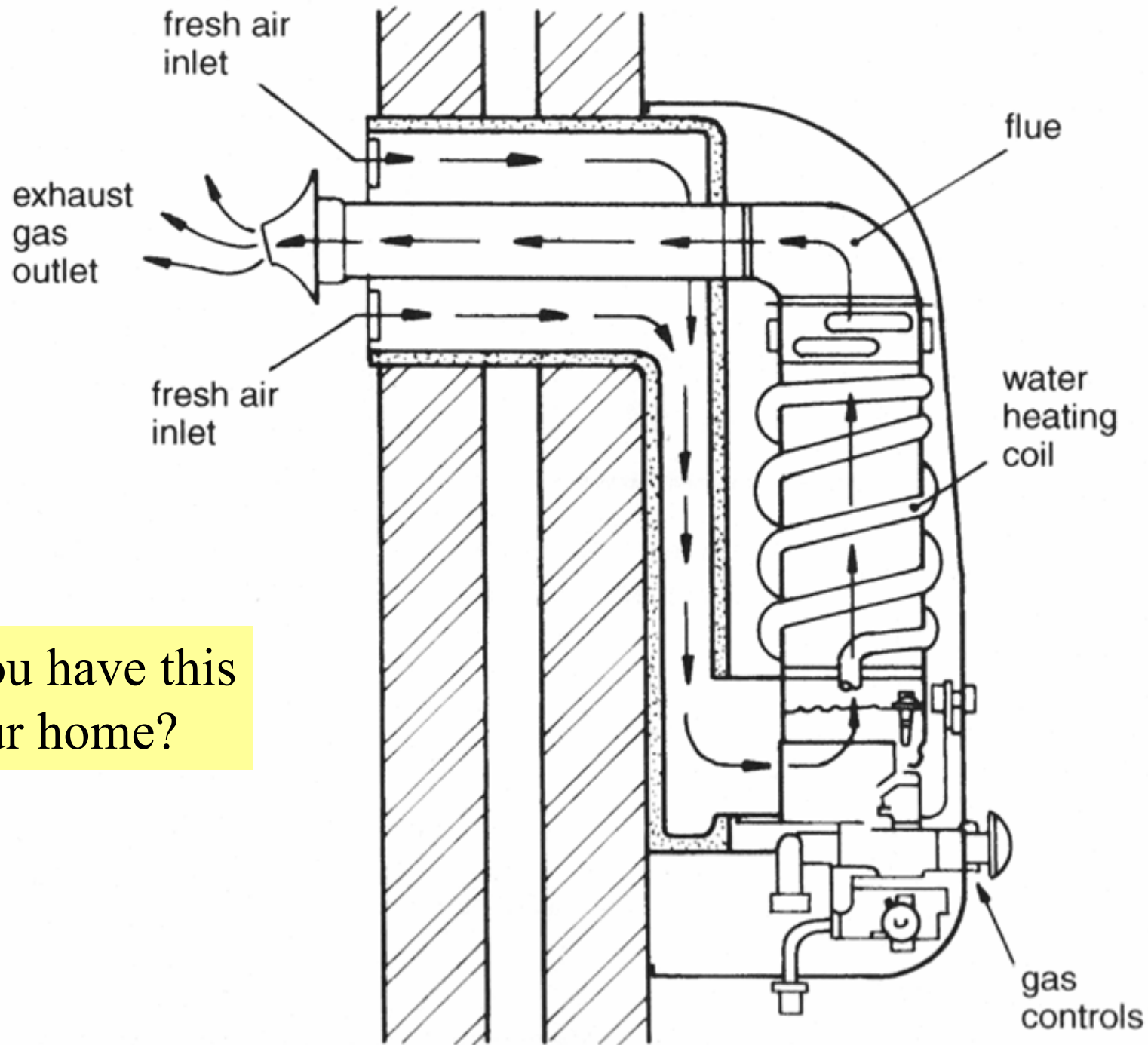

Do you have this  
at your home?

# How to design and locate gas water heaters?

## Acceptable Locations of Room-Sealed Gas Water Heater Terminals

### EXTERNAL VIEW

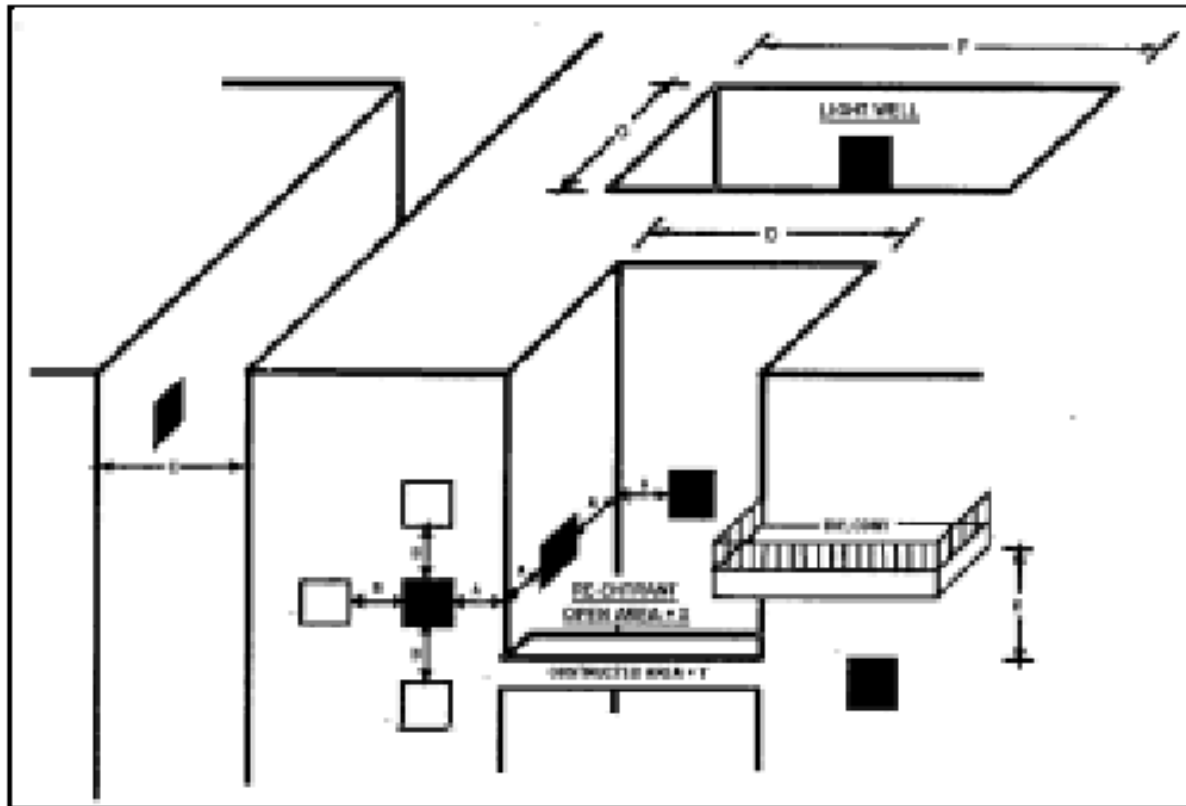

Dimension		Minimum Distance
A	From any corner of building	300 mm*
B	From any adjacent opening into building	300 mm
C	From facing wall or boundary	1 500 mm*
D	Minimum plan width of re-entrant	1 500 mm*
E	Below a balcony or similar projection	300 mm*
F	Light well plan area (F x G)	
& G	10 or less storeys	3 000 mm
	11-19 storeys	4 000 mm
	20 or more storeys	5 000 mm

\* May be reduced for fanned draught models.  
See manufacturer's instructions.

What are the key design factors?

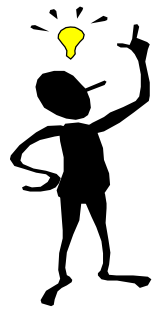

# Design considerations

- Gas pipes in buildings
  - Installation pipe, service pipe, gas main
  - Most common materials: mild steel to BS 1387
    - Copper & uPVC are used in some countries
  - Precautions
    - Should not fitted inside chamber or pipe duct with electrical devices (sparks may cause fire or explosion)
    - Spacing & insulation when contact with other service (reduce the risk of excessive heat and leakage)
    - Sufficient free area for ventilation in gas pipe shafts (such as grille at the highest point)

# Example 1: Location of fire safety valve inside premises

(Service riser supplying more than one customer)

*Shopping arcade/common corridor*

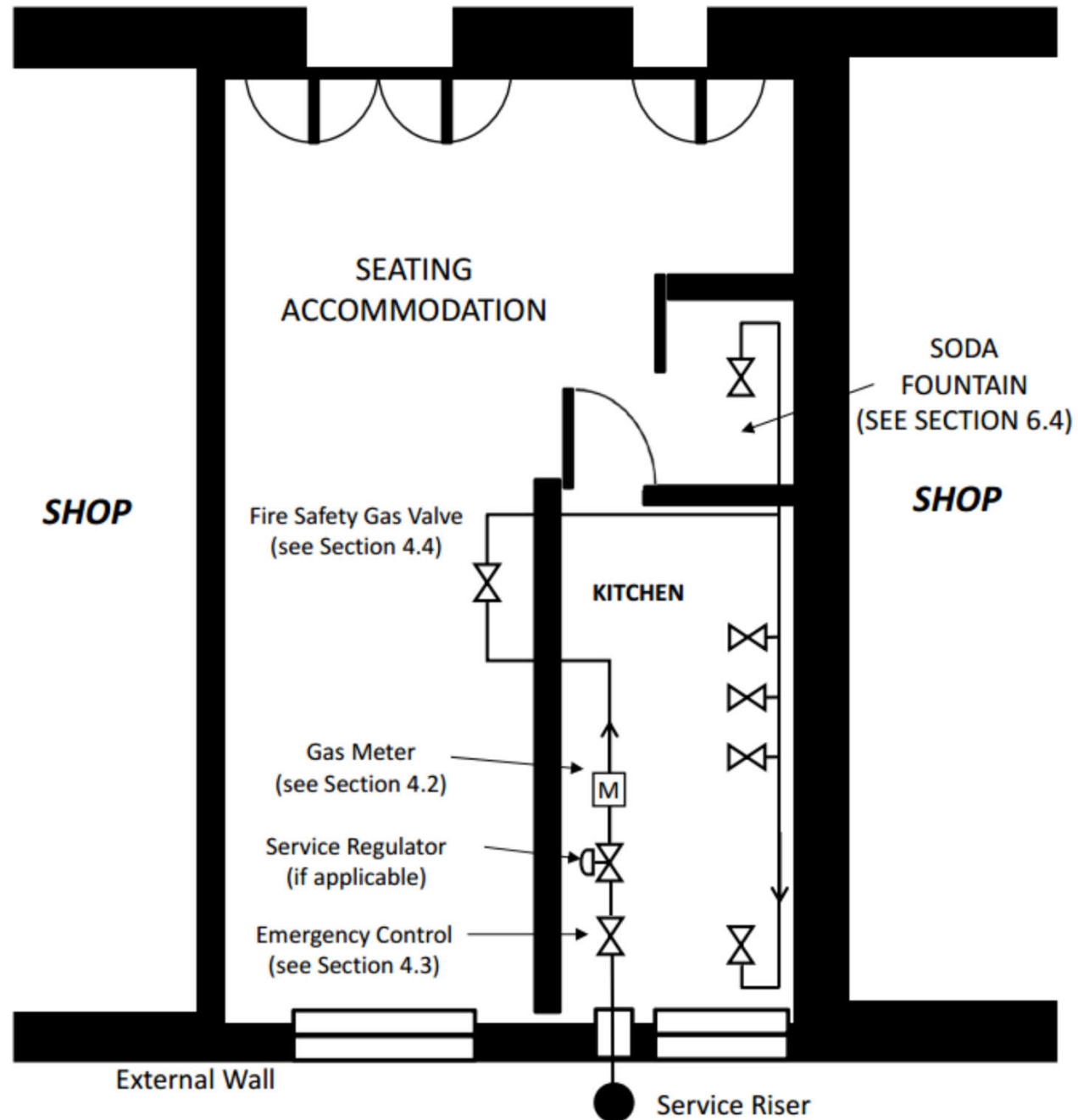

**Example 2: Location of fire safety valve external to premises.**

**Single gas supply to restaurant (G/F level or above).**

(Service riser supplying one customer)  
*Shopping arcade/common corridor*

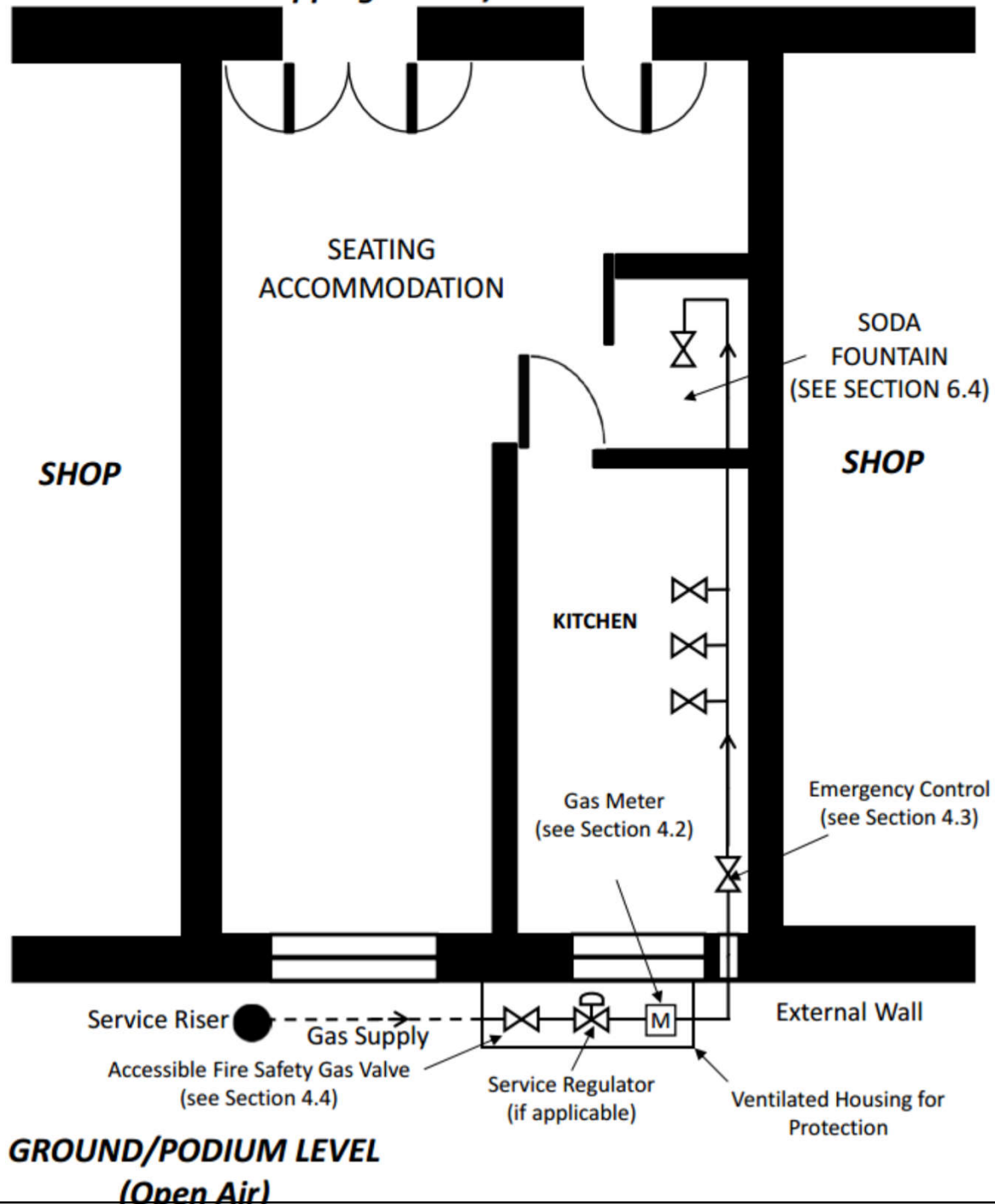

**Example 3: Location of fire safety valve external to premises.**

**Single gas supply to restaurant on G/F or podium level.**

(Fire safety and emergency control valves can be a single valve in this situation)

***Shopping arcade/common corridor***

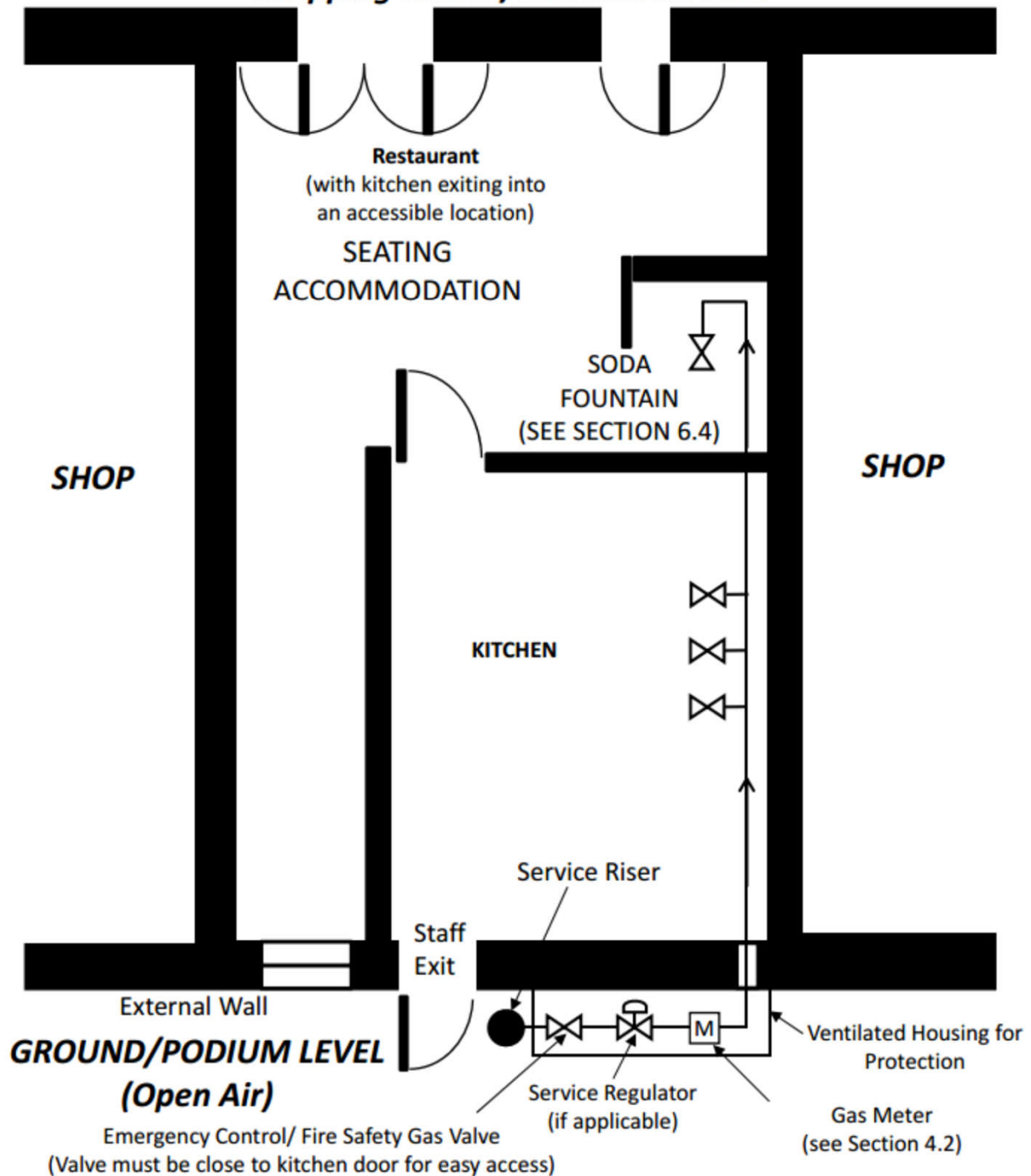

(Source: EMSD)

**Example 4: Location of fire safety valve close to kitchen exit/entrance**  
(Service riser supplying more than one customer and unable to install fire safety valve outside kitchen)

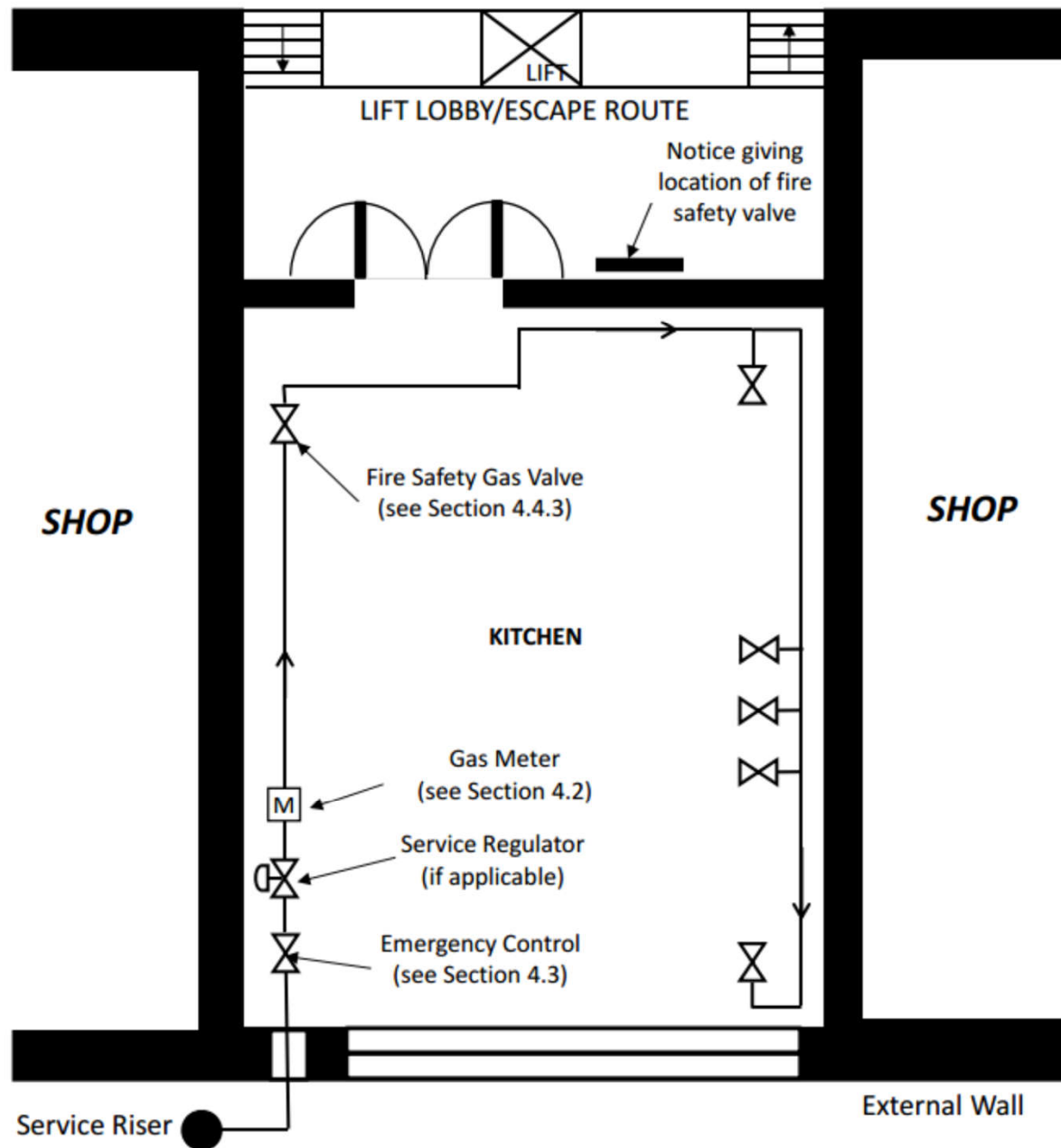

**ABOVEGROUND/PODIUM LEVEL**  
**(Open Air)**

(Source: EMSD)

# Gas flow and pressure controls for LPG chamber installation

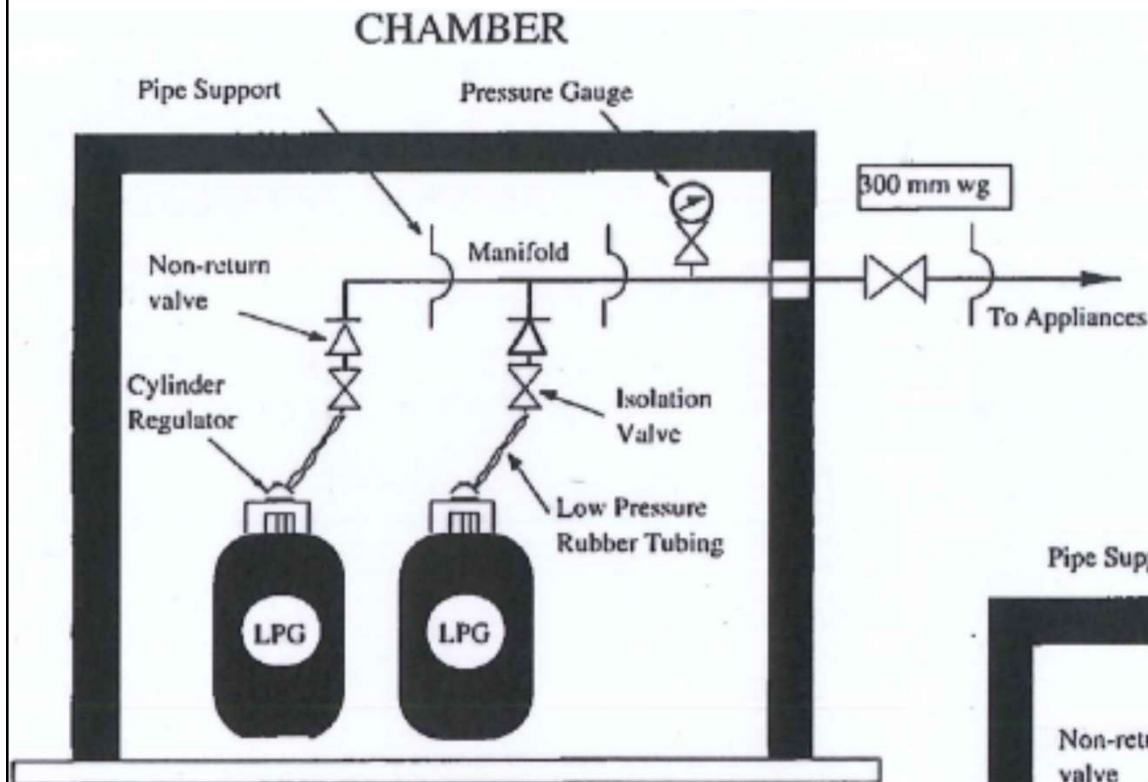

5.1 Using Low Pressure Cylinder Regulators

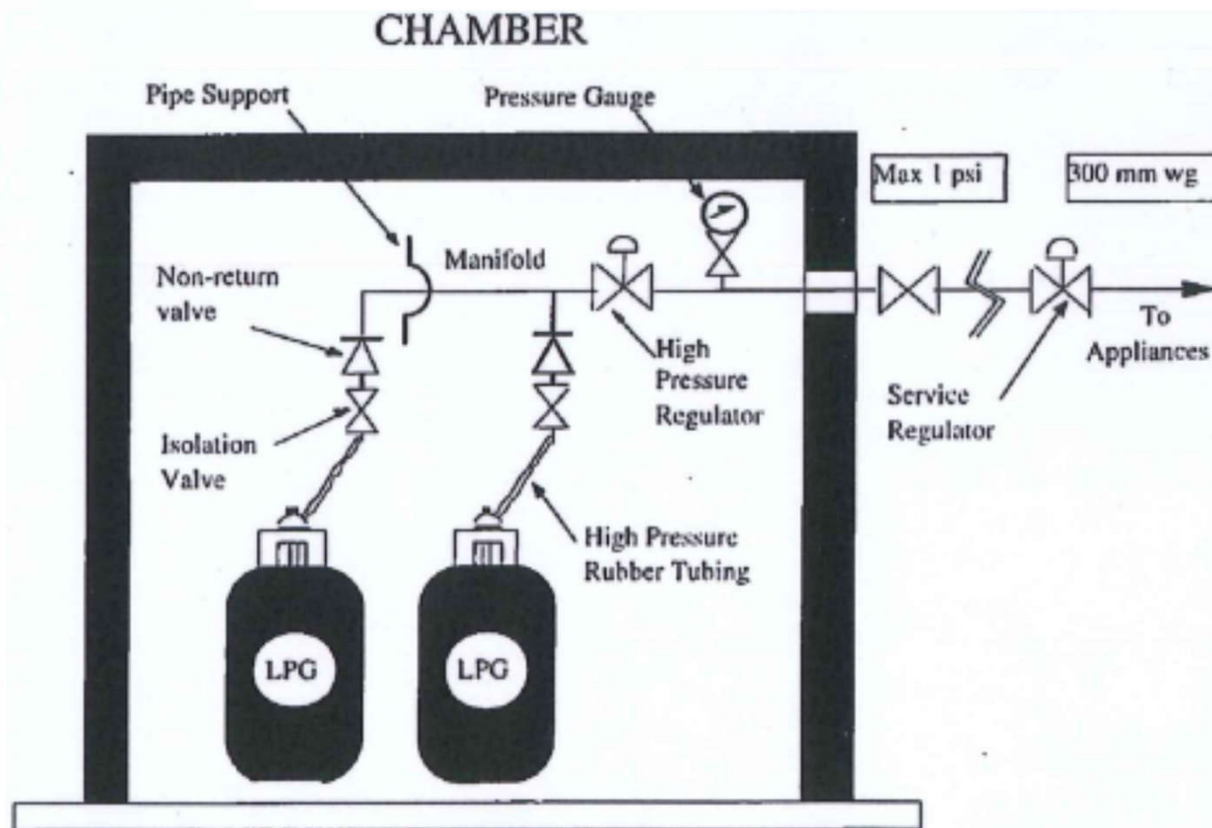

5.2 Using High Pressure Regulator and Service Regulator



# Gas pipe sizing

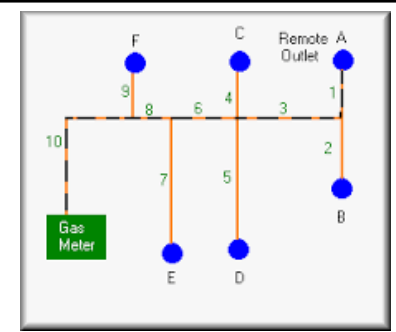

- The flow of gas in pipes depends on:
  - The internal diameter of the pipe
  - The pressure of gas
  - The type of pipe material used
  - The relative density of the gas
  - The length of pipe and resistance of fittings
- Gas consumption of an appliance is related to:
  - $\text{Rated heat output (kW)} / \text{Calorific value (MJ/m}^3\text{)}$

## Gas flow rates in pipes

The [Pole formula](#) is used in the gas industry for determining the flow rate of gas in pipes. It is a simplification of the Darcy fluid flow formula.

$$Q = 0.0071 \sqrt{\frac{h \times d^5}{s \times l}} \quad (m^3/hr)$$

where: 0.0071 is a constant friction coefficient

$h$  = pressure loss in millibars (mb)

$d$  = pipe diameter (mm)

$s$  = specific gravity of gas (natural gas approx. 0.6)

$l$  = length of pipe conveying gas (m)

The Pole formula can be rearranged to make pressure loss ( $h$ ) the subject:

$$h = \frac{Q^2 \times s \times l}{d^5 \times (0.0071)^2} \quad (\text{millibars})$$

It can be seen that the pressure loss ( $h$ ) is directly proportional to:

- the square of the flow rate ( $Q$ )
- the gas specific gravity ( $s$ )
- the pipe length ( $l$ )

Note: Pole's formula is limited to normal low-pressure gas installations. Under higher pressure, alternative formulae which incorporate gas compressibility factors are more appropriate.

# Gas pipe sizing

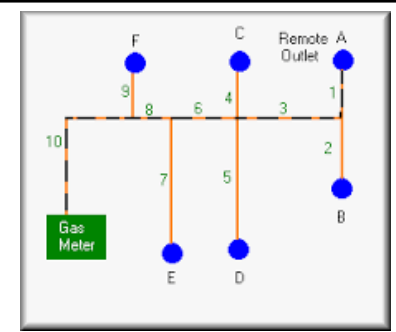

- Sizing calculations

- It depends on gas pressure of incoming service & that required by appliances
- Found from manufacturer's literature or calculated from heat output & efficiency
  - Most gas appliance has efficiency of 75%
  - Maximum allowable gas pressure drop = 75 Pa
- Gas flow rate ( $Q$ , l/s) can be calculated as:

$$Q = \frac{H}{\text{eff} \times GCV}$$

$H$  = appliance heat output (kW)

$\text{eff}$  = appliance efficiency

$GCV$  = gross calorific value (MJ/m<sup>3</sup>)

# Gas pipe sizing

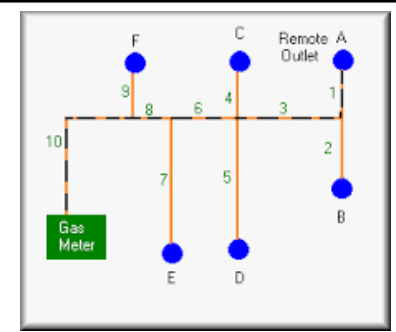

- Sizing calculations (cont'd)
  - To determine the size of pipework, two factors must be established:
    - 1. The gas consumption ( $Q$ )
    - 2. The effective length of pipework
  - The effective length of pipework is taken as the actual length plus the allowances for fittings in installations (e.g. elbow, tee, bend)

## Gas pipe sizing (typical data)

Fitting	Equivalent length (m)
elbow	0.5
tee	0.5
bend (90°)	0.3

The gas discharge in m<sup>3</sup>/hour for copper tube for varying effective lengths is as follows:

Tube diam. (mm o.d)	Effective pipe length (m)							
	3	6	9	12	15	20	25	30
8	0.52	0.26	0.17	0.13	0.10	0.07		
10	0.86	0.57	0.50	0.37	0.30	0.22	0.18	0.15
12	1.50	1.00	0.85	0.82	0.69	0.52	0.41	0.34
15	2.90	1.90	1.50	1.30	1.10	0.95	0.92	0.88
22	8.70	5.80	4.60	3.90	3.40	2.90	2.50	2.30
28	18.00	12.00	9.40	8.00	7.00	5.90	5.20	4.70

This table is appropriate for 1mb (10mm w.g.) pressure drop for gas of relative density 0.6.

## Gas pipe sizing (example)

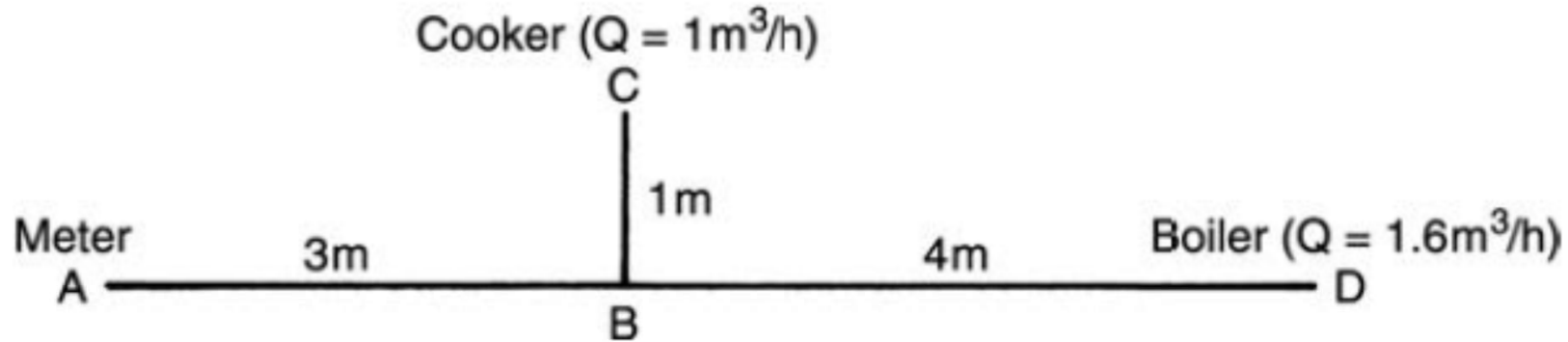

Note: A to B contains 3 elbows and 1 tee

B to C contains 3 elbows

B to D contains 4 elbows

Pipe A to B, gas flow =  $1 \text{ m}^3/\text{h} + 1.6 \text{ m}^3/\text{h} = 2.6 \text{ m}^3/\text{h}$

Actual pipe length = 3m

Effective pipe length =  $3 + (3 \times 0.5) + (1 \times 0.5) = 5 \text{ m}$

From the table, a 22mm o.d. copper tube can supply  $2.6 \text{ m}^3/\text{h}$  for up to 23.75 metres (by interpolating between 20 and 25m).

Pressure drop over only 5m will be:  $5 \div 23.75 = 0.21 \text{ mb}$  (2.1mm w.g.).

Pipes B to C and B to D can be calculated similarly.

## Pipe sizing example (NG) for a typical copper tube gas installation

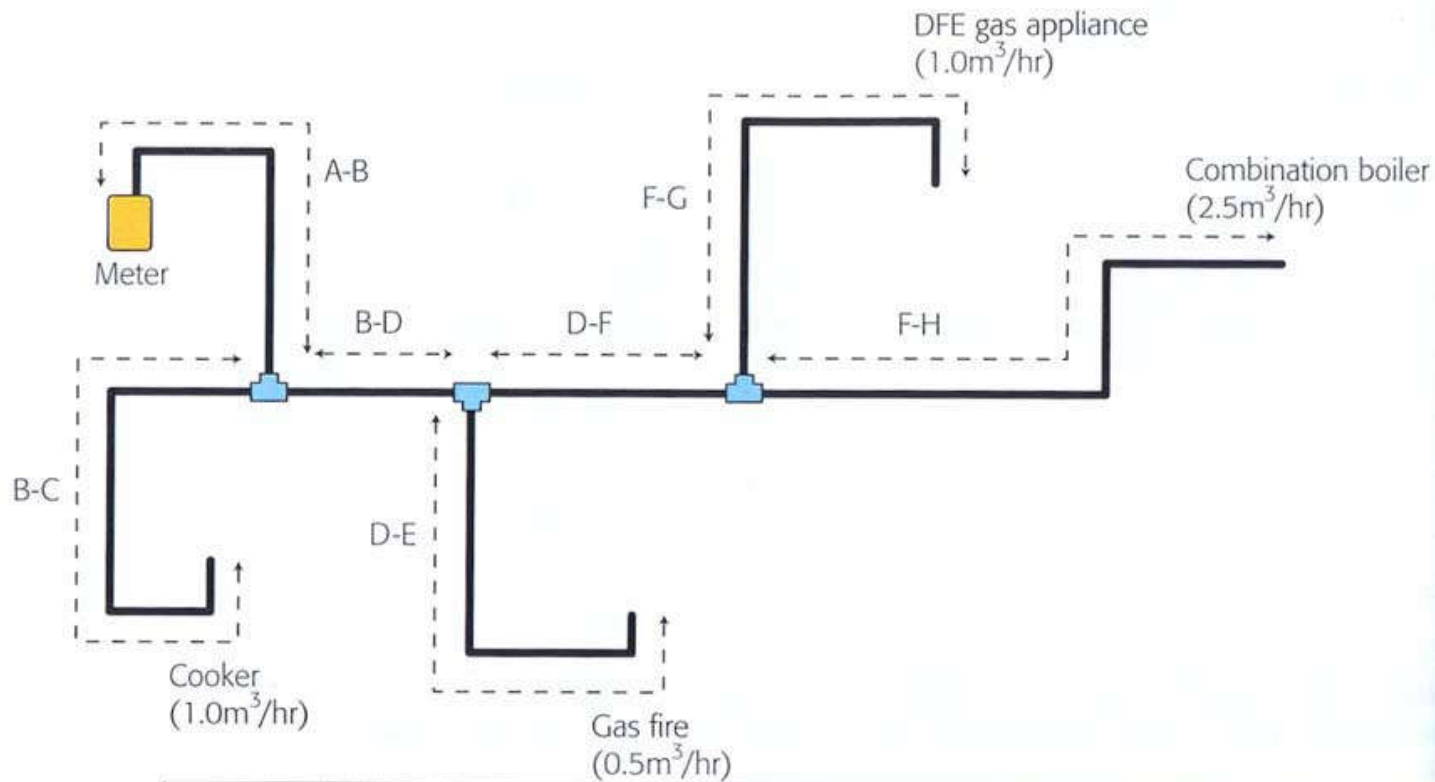

Pipe section (Figure 5.4)	Gas rate m <sup>3</sup> /hr	Pipe length m	Equivalent length fitting		Total length m	Pipe Diameter mm
			Type	Equivalent length m		
A-B	5	3	2 elbows 1 tee	1 0.5	4.5	28
B-C	1	1	3 elbows	1.5	2.5	15
B-D	4	2	1 tee	0.5	2.5	28
D-E	0.5	1	2 elbows	1	2	10
D-F	3.5	2	1 tee	0.5	2.5	22
F-G	1	1	2 elbows	1	2	15
F-H	2.5	3	2 elbows	1	4	22

# Gas pipe sizing

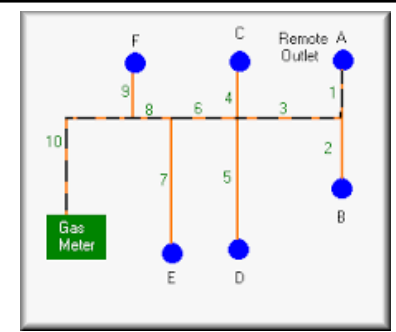

- Sizing calculations [example]
  - Gas properties
    - Allowable pressure drops
    - Gas pressures
  - Simple method of natural gas pipe sizing
    - 3 tables are for steel, thin wall & thick wall copper
  - CIBSE method of gas pipe sizing
    - CIBSE Guide C, Table C4.45 (steel) and C4.46 (copper) for natural and LPG pipe sizing



# Example of gas pipe sizing table

Section Ref.	1 Heat Output in section kW	2 Flow rate m <sup>3</sup> /s	3 Pipe Size mm dia	4 Length of pipe m	5 Total Equivalent length of Fittings m	6 Total Pipe Length Col. 4+5 m	7 Pressure drop per metre Pa/m	8 TOTAL PRESSURE DROP Col. 6 x 7 Pa	9 Pressure at start of section Pa	10 Pressure at end of section Pa
1	41	0.00106	<b>28</b>	8	Zeta factor for Tee = 0.5 + 1.0 + 0.25 = 1.75 T.E.L. = $\zeta \times l_e$ = 1.75 x 0.7 = 1.23 m	8 + 1.23 = 9.23	2.2	<b>20.31</b>		
2	16	0.000413	<b>15</b>	4	Tee 0.5 + 1.0 = 1.5 T.E.L. = $\zeta \times l_e$ = 1.5 x 0.4 = 0.6 m	4 + 0.6 = 4.6	8.3	<b>38.18</b>		
3	4	0.000103	<b>15</b>	13	3 bends @ 1.0 = 3.0 1 plug valve = 1.0 Total $\zeta$ = 4.0 T.E.L. = 4.0 x 0.2 = 0.8 m	13 + 0.8 = 13.8	1.3	<b>17.94</b>		
4	25	0.00065	<b>22</b>	5	2 bends @ 1.0 = 2.0 1 plug valve = 1.0 T.E.L. = $\zeta \times l_e$ T.E.L. = 3.0 x 0.5 = 1.5 m	5 + 1.5 = 6.5	3.0	<b>19.5</b>		
5	12	0.00031	<b>15</b>	4	1 plug valve = 1.0 T.E.L. = $\zeta \times l_e$ T.E.L. = 1.0 x 0.4 = 0.4 m	4 + 0.4 = 4.4	4.0	<b>17.6</b>		

# Example – gas pipe system with sizing information

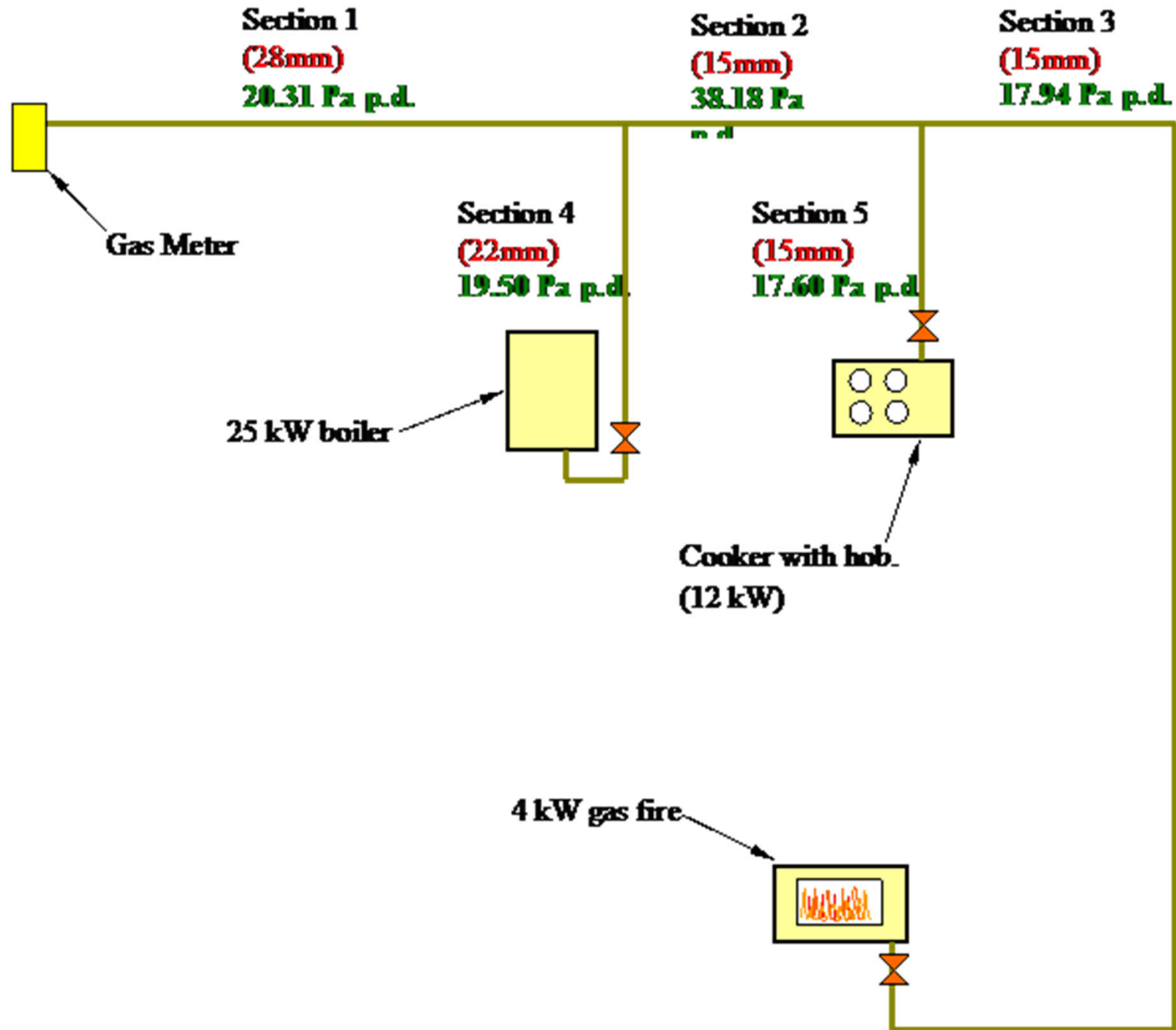



# Further Reading

- EMSD, 2016. *Code of Practice GU 21 Requirements for Town Gas Installations for Catering Purposes in Restaurants and Food Preparation Establishments*, Gas Authority, Electrical and Mechanical Services Department, Hong Kong.  
[https://www.emsd.gov.hk/en/gas\\_safety/publications/codes\\_of\\_practice/](https://www.emsd.gov.hk/en/gas_safety/publications/codes_of_practice/)
- Gas Safety Portal (EMSD) <https://www.emsd.gov.hk/gsp/en/>
  - Overview on Gas Safety <http://www.gsp.emsd.gov.hk/en/b01.html>
  - Gas Installation Work and Registered Gas Contractors  
<http://www.gsp.emsd.gov.hk/en/b04.html>
- Gas pipe sizing  
[http://wiki.diyfaq.org.uk/index.php/Gas\\_pipe\\_sizing](http://wiki.diyfaq.org.uk/index.php/Gas_pipe_sizing)

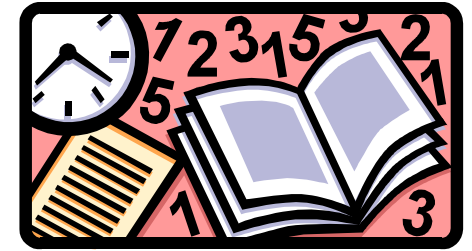

# References

- Gas Authority Hong Kong, 2018. *Code of Practice: Avoidance of Damage to Gas Pipes*, 2nd Edition, Gas Authority, the Government of the Hong Kong Special Administrative Region, Hong Kong.  
[https://www.emsd.gov.hk/en/gas\\_safety/publications/codes\\_of\\_practice/](https://www.emsd.gov.hk/en/gas_safety/publications/codes_of_practice/)
- Hall F. & Greeno R., 2017. *Building Services Handbook*, 9th ed., Chapter 10, Routledge, Oxon & New York.
- IGEM, 2013. *Defining the End of the Network, a Meter Installation and Installation Pipework*, IGEM/G/1 Edition 2, Communication 1765, Institution of Gas Engineers and Managers (IGEM), Derbyshire, UK.
  - <https://www.igem.org.uk/resources/assets/attachment/full/0/15081.pdf>
- IGEM, 2012. *Definitions for the Gas Industry*, IGEM/G/4 Edition 2, Communication 1763, Institution of Gas Engineers and Managers (IGEM), Derbyshire, UK. <https://www.igem.org.uk/technical-services/technical-gas-standards/general/igem-g-4-edition-2-definitions-for-the-gas-industry/>