

Load Estimation



Dr. Sam C. M. Hui

Department of Mechanical Engineering

The University of Hong Kong

E-mail: cmhui@hku.hk

Contents

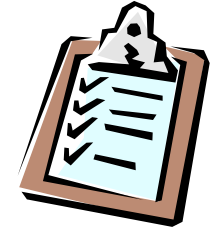

- Basic Concepts
- Outdoor Design Conditions
- Indoor Design Conditions
- Cooling Load Components
- Cooling Load Principles
- Cooling Coil Load
- Heating Load
- Software Applications

Basic Concepts

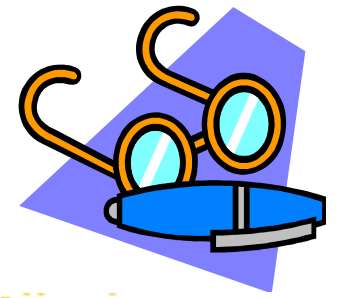

- Heat transfer mechanism

- Conduction
- Convection
- Radiation

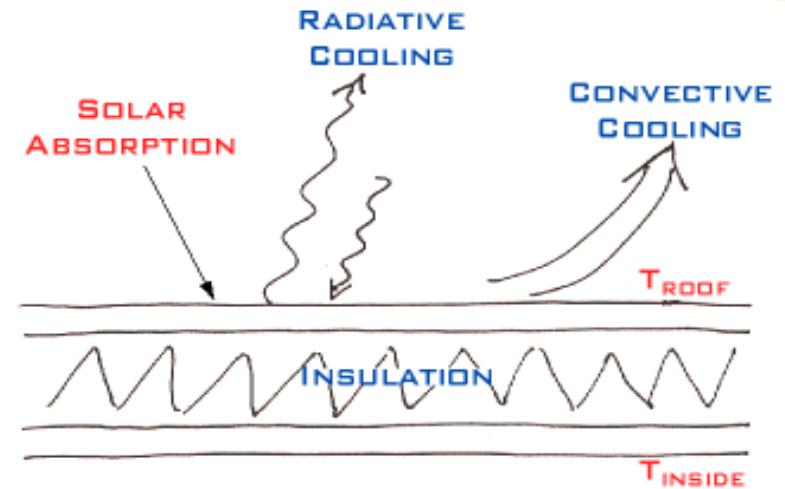

$$Q_{IN} = U \cdot (T_{ROOF} - T_{INSIDE})$$

- Thermal properties of building materials

- Overall thermal transmittance (U-value)
- Thermal conductivity
- Thermal capacity (specific heat)

$$Q = U A (\Delta t)$$

Four forms of heat transfer

CONDUCTION

From molecule to molecule

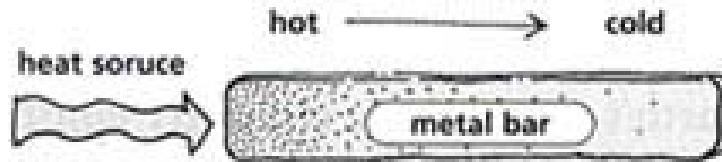

SENSIBLE HEAT

Fluid movement of heated air

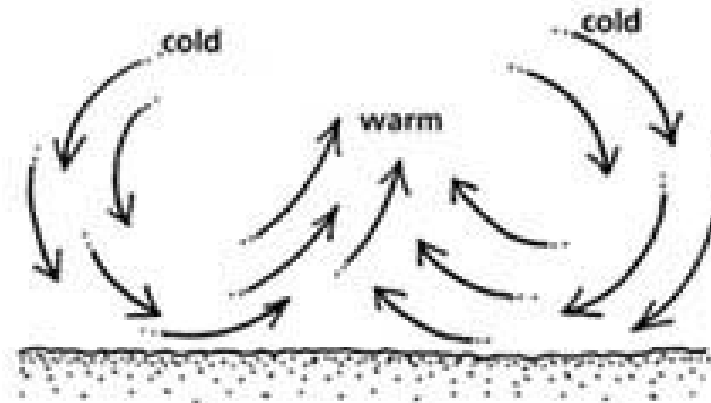

CONVECTION

RADIATION

Energy passing from one object to another without a connecting medium

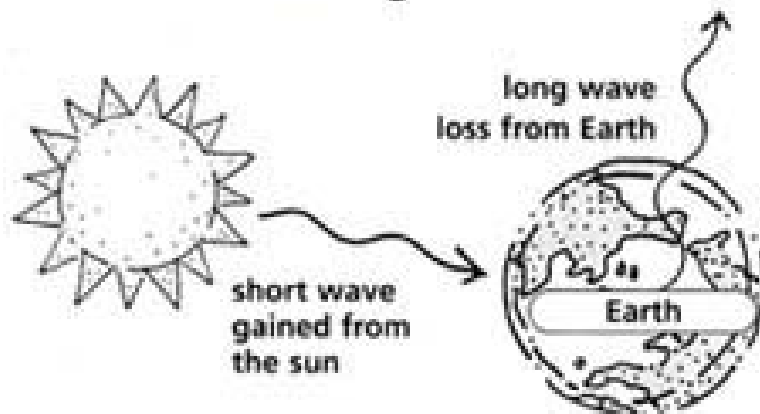

LATENT HEAT

Chemical energy due to water phase changes (evaporation, condensation, etc.) and water vapour transfer

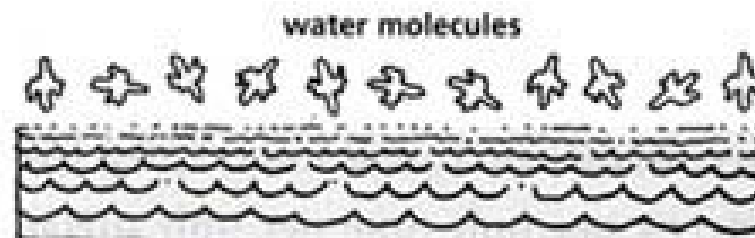

Basic Concepts

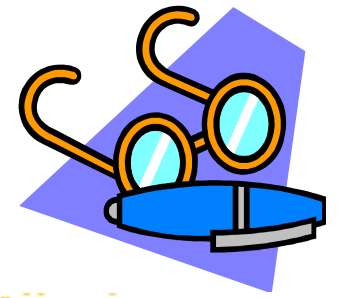

- Thermal transmission in buildings
 - http://www.arca53.dsl.pipex.com/index_files/tt1.htm
 - External walls, windows, roof, doors and floors
 - Insulation (thermal) to reduce the heat transfer
 - Ventilation (infiltration and exfiltration)
 - Thermal properties of building materials and construction components
 - Examples of U-value calculations
 - http://www.arca53.dsl.pipex.com/index_files/tt4.htm

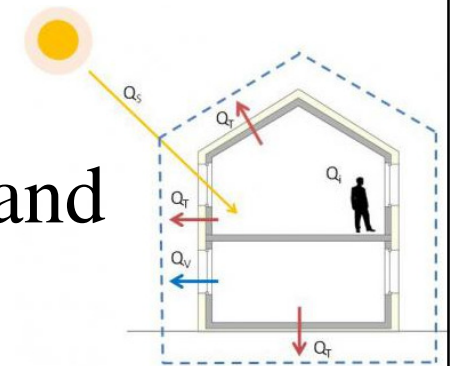

Basic Concepts

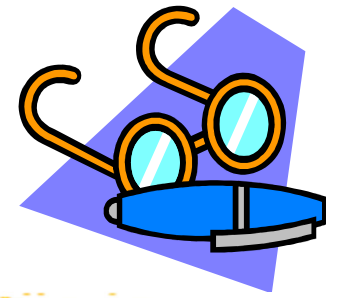

- Calculating heat gains

- http://www.arca53.dsl.pipex.com/index_files/hgain1.htm

- Heat gain through external walls

- Heat gain through roof

- Solar heat gain through window glass

- Conduction heat through window glass

- Internal heat gains

- Ventilation and/or infiltration heat gains

- Latent heat gains (moisture transfer/generation)

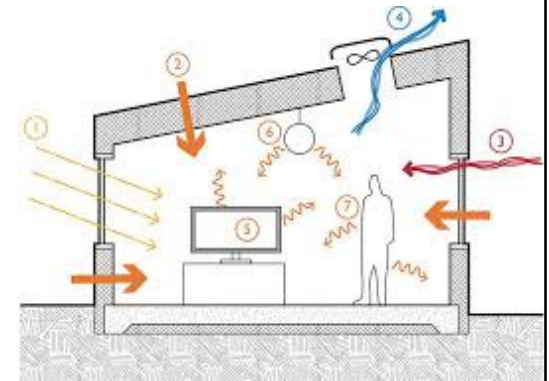

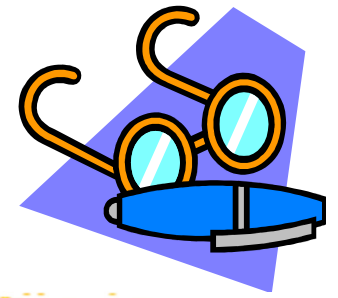

Basic Concepts

- Heat transfer basic relationships (for air at sea level) (SI units)
 - Sensible heat transfer rate:
 - $q_{\text{sensible}} = 1.23 \text{ (Flow rate, L/s)} (\Delta t)$
 - Latent heat transfer rate:
 - $q_{\text{latent}} = 3010 \text{ (Flow rate, L/s)} (\Delta w)$
 - Total heat transfer rate:
 - $q_{\text{total}} = 1.2 \text{ (Flow rate, L/s)} (\Delta h)$
 - $q_{\text{total}} = q_{\text{sensible}} + q_{\text{latent}}$

Basic Concepts

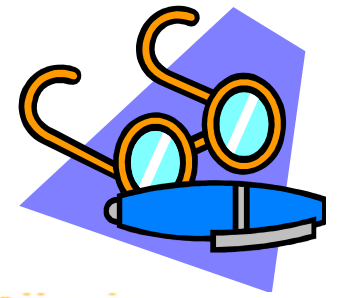

- Thermal load
 - The amount of heat that must be added or removed from the space to maintain the proper temperature in the space
- When thermal loads push conditions outside of the comfort range, HVAC systems are used to bring the thermal conditions back to comfort conditions



Basic Concepts

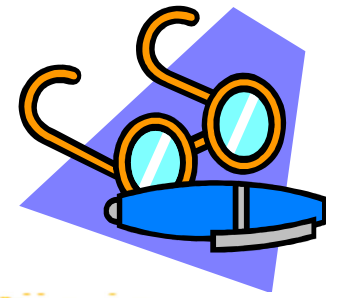

- Purpose of HVAC load estimation
 - Calculate peak design loads (cooling/heating)
 - Estimate likely plant/equipment capacity or size
 - Specify the required airflow to individual spaces
 - Provide info for HVAC design e.g. load profiles
 - Form the basis for building energy analysis
- Cooling load is our main target
 - Important for warm climates & summer design
 - Affect building performance & its first cost

Basic Concepts

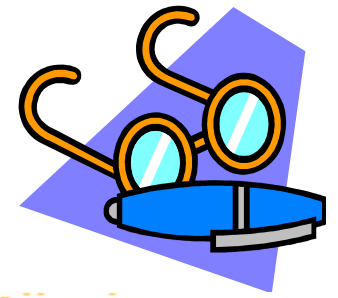

- General procedure for cooling load calculations
 - 1. Obtain the characteristics of the building, building materials, components, etc. from building plans and specifications
 - 2. Determine the building location, orientation, external shading (like adjacent buildings)
 - 3. Obtain appropriate weather data and select outdoor design conditions
 - 4. Select indoor design conditions (include permissible variations and control limits)

Basic Concepts

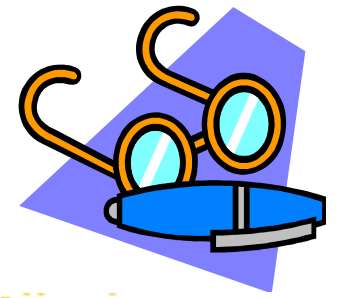

- General procedure for cooling load calculations (cont'd)
 - 5. Obtain a proposed schedule of lighting, occupants, internal equipment appliances and processes that would contribute to internal thermal load
 - 6. Select the time of day and month for the cooling load calculation
 - 7. Calculate the space cooling load at design conditions
 - 8. Assess the cooling loads at several different time or a design day to find out the peak design load

Total Cooling Load - Tons

January Through June

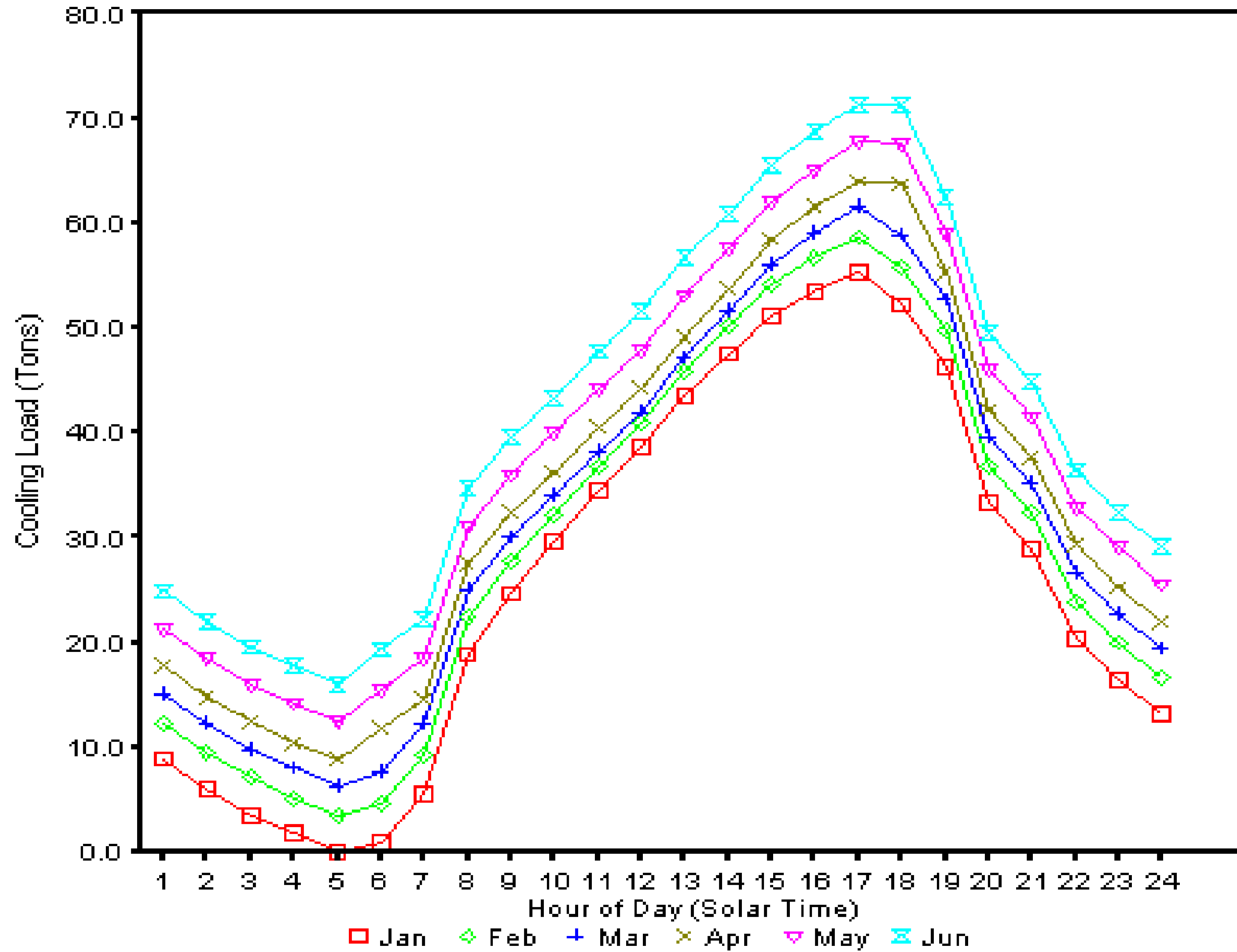

Cooling load profiles

Basic Concepts

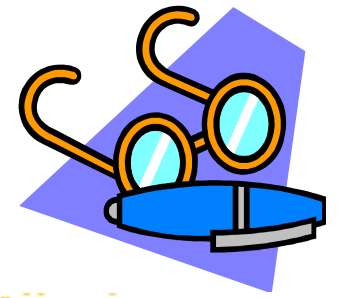

- A building survey will help us achieve a realistic estimate of thermal loads
 - Orientation of the building
 - Use of spaces
 - Physical dimensions of spaces
 - Ceiling height
 - Columns and beams
 - Construction materials
 - Surrounding conditions
 - Windows, doors, stairways

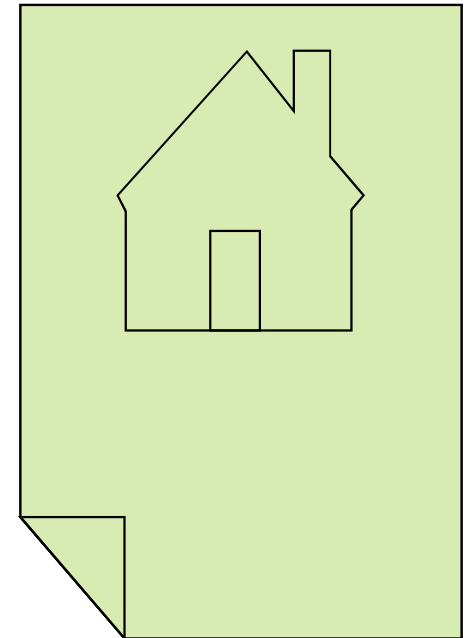

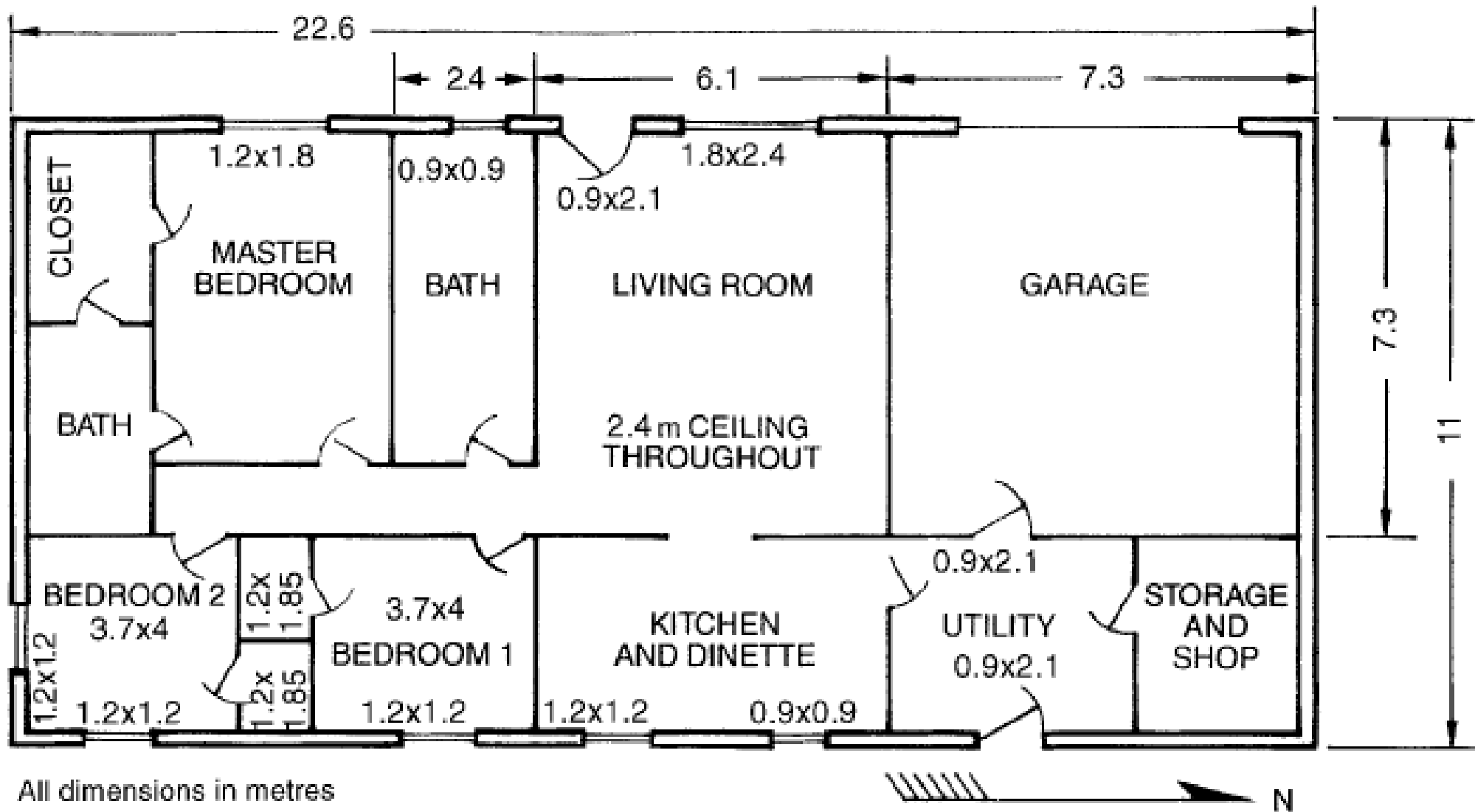

Basic Concepts

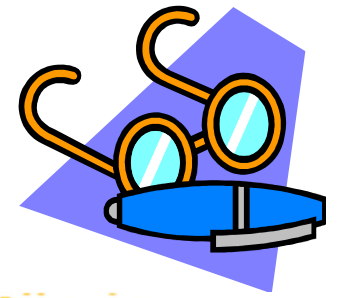

- Key info for load estimation
 - People (number or density, duration of occupancy, nature of activity)
 - Lighting (W/m^2 , type)
 - Appliances (wattage, location, usage)
 - Ventilation (criteria, requirements)
 - Thermal storage (if any)
 - Continuous or intermittent operation

Basic Concepts

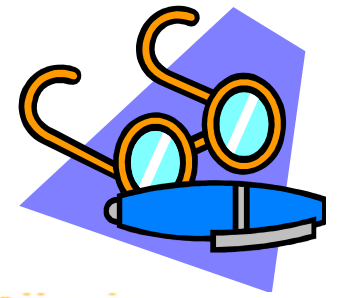

- Typical HVAC load design process
 - 1. Rough estimates of design loads & energy use
 - Such as by rules of thumb & floor areas
 - See “Cooling Load Check Figures” *
 - See references for some examples of databooks
 - 2. Develop & assess more info (design criteria, building info, system info)
 - Building layouts & plans are developed
 - 3. Perform detailed load & energy calculations

Basic Concepts

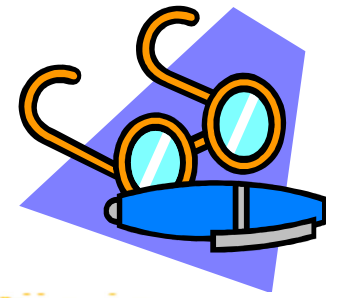

- Issues with oversizing
 - Since getting an accurate cooling load estimate can be difficult (or even impossible at an early design stage) some engineers design conservatively and deliberately oversize systems
 - Oversizing a system is problematic because:
 - They are less efficient, harder to control, and noisier than properly sized systems
 - They tend to duty cycle (turn on and off) which reduces reliability and increases maintenance costs
 - They take up more space and cost more

Outdoor Design Conditions

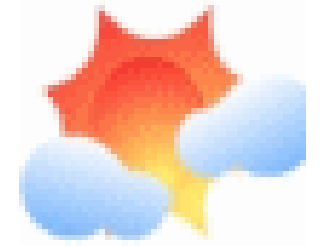

- They are used to calculate design space loads
- Climatic design information
 - General info: e.g. latitude, longitude, altitude, atmospheric pressure
 - Outdoor design conditions include
 - Derived from statistical analysis of weather data
 - Typical data can be found in handbooks/databooks, such as ASHRAE Fundamentals Handbook

Outdoor Design Conditions

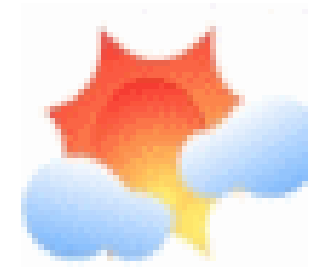

- Climatic design info from ASHRAE
 - Previous data & method (before 1997)
 - For Summer (Jun to Sep) & Winter (Dec, Jan, Feb)
 - Based on 1%, 2.5% & 5% nos. hours of occurrence
 - New method (ASHRAE Fundamentals 2001+):
 - Based on annual percentiles and cumulative frequency of occurrence, e.g. 0.4%, 1%, 2% (of whole year)
 - More info on coincident conditions
 - Findings obtained from ASHRAE research projects
 - Data can be found on a relevant CD-ROM

Outdoor Design Conditions

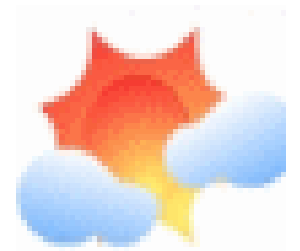

- Climatic design conditions (ASHRAE, 2009):
 - Annual heating & humidif. design conditions
 - Coldest month
 - Heating dry-bulb (DB) temp.
 - Humidification dew point (DP)/ mean coincident dry-bulb temp. (MCDB) and humidity ratio (HR)
 - Coldest month wind speed (WS)/mean coincident dry-bulb temp. (MCDB)
 - Mean coincident wind speed (MCWS) & prevailing coincident wind direction (PCWD) to 99.6% DB

Outdoor Design Conditions

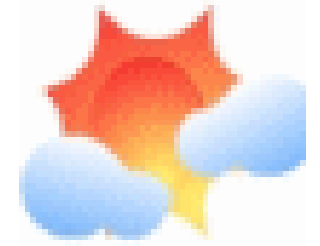

- Climatic design conditions (ASHRAE, 2009):
 - Cooling and dehumidification design conditions
 - Hottest month and DB range
 - Cooling DB/MCWB: Dry-bulb temp. (DB) + Mean coincident wet-bulb temp. (MCWB)
 - Evaporation WB/MCDB: Web-bulb temp. (WB) + Mean coincident dry-bulb temp. (MCDB)
 - MCWS/PCWD to 0.4% DB
 - Dehumidification DP/MCDB and HR: Dew-point temp. (DP) + MDB + Humidity ratio (HR)
 - Enthalpy/MCDB

Outdoor Design Conditions

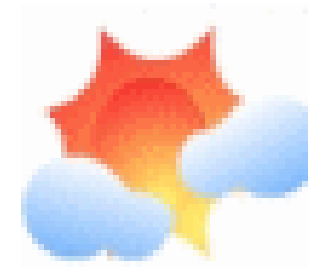

- Climatic design conditions (ASHRAE, 2009):
 - Extreme annual design conditions
 - Monthly climatic design conditions
 - Temperature, degree-days and degree-hours
 - Monthly design DB and mean coincident WB
 - Monthly design WB and mean coincident DB
 - Mean daily temperature range
 - Clear sky solar irradiance

Outdoor Design Conditions

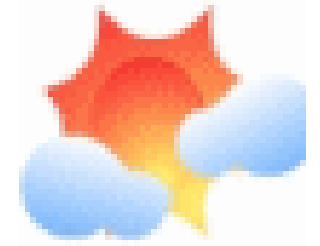

- Other sources of climatic info:
 - Joint frequency tables of psychrometric conditions
 - Annual, monthly and hourly data
 - Degree-days (cooling/heating) & climatic normals
 - To classify climate characteristics
 - Typical year data sets (1 year: 8,760 hours)
 - For energy calculations & analysis

Recommended Outdoor Design Conditions for Hong Kong

| | | | | | |
|----------------------|---|-------------------|---|-------------------|-----------------|
| Location | Hong Kong (latitude 22° 18' N, longitude 114° 10' E, elevation 33 m) | | | | |
| Weather station | Royal Observatory Hong Kong | | | | |
| Summer months | June to September (four hottest months), total 2928 hours | | | | |
| Winter months | December, January & February (three coldest months), total 2160 hours | | | | |
| Design temperatures: | For comfort HVAC (based on summer 2.5% or annualised 1% and winter 97.5% or annualised 99.3%) | | For critical processes (based on summer 1% or annualised 0.4% and winter 99% or annualised 99.6%) | | |
| | Summer | Winter | Summer | Winter | |
| | DDB / CWB | 32.0 °C / 26.9 °C | 9.5 °C / 6.7 °C | 32.6 °C / 27.0 °C | 8.2 °C / 6.0 °C |
| | CDB / DWB | 31.0 °C / 27.5 °C | 10.4 °C / 6.2 °C | 31.3 °C / 27.8 °C | 9.1 °C / 5.0 °C |

- Note:
1. DDB is the design dry-bulb and CWB is the coincident wet-bulb temperature with it; DWB is the design wet-bulb and CDB is the coincident dry-bulb with it.
 2. The design temperatures and daily ranges were determined based on hourly data for the 35-year period from 1960 to 1994; extreme temperatures were determined based on extreme values between 1884-1939 and 1947-1994.

(Source: Research findings from Dr. Sam C M Hui)

Recommended Outdoor Design Conditions for Hong Kong (cont'd)

| | | | | |
|-----------------------|---|---------------|---|--|
| Extreme temperatures: | Hottest month: July mean DBT = 28.6 °C absolute max. DBT = 36.1 °C mean daily max. DBT = 25.7 °C | | Coldest month: January mean DBT = 15.7 °C absolute min. DBT = 0.0 °C mean daily min. DBT = 20.9 °C | |
| Diurnal range: | Summer | Winter | Whole year | |
| - Mean DBT | 28.2 | 16.4 | 22.8 | |
| - Daily range | 4.95 | 5.01 | 5.0 | |
| Wind data: | Summer | Winter | Whole year | |
| - Wind direction | 090 (East) | 070 (N 70° E) | 080 (N 80° E) | |
| - Wind speed | 5.7 m/s | 6.8 m/s | 6.3 m/s | |

Note: 3. Wind data are the prevailing wind data based on the weather summary for the 30-year period 1960-1990. Wind direction is the prevailing wind direction in degrees clockwise from north and the wind speed is the mean prevailing wind speed.

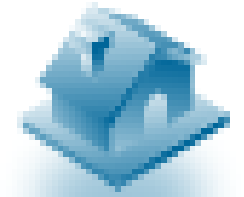

Indoor Design Conditions

- Basic design parameters: (for thermal comfort)
 - Air temp. & air movement
 - Typical: summer 24-26 °C; winter 21-23 °C
 - Air velocity: summer < 0.25 m/s; winter < 0.15 m/s
 - Relative humidity
 - Summer: 40-50% (preferred), 30-65 (tolerable)
 - Winter: 25-30% (with humidifier); not specified (w/o humidifier)
 - See also ASHRAE Standard 55
 - ASHRAE comfort zone

ASHRAE Comfort Zones

(based on 2004 version of ASHRAE Standard 55)

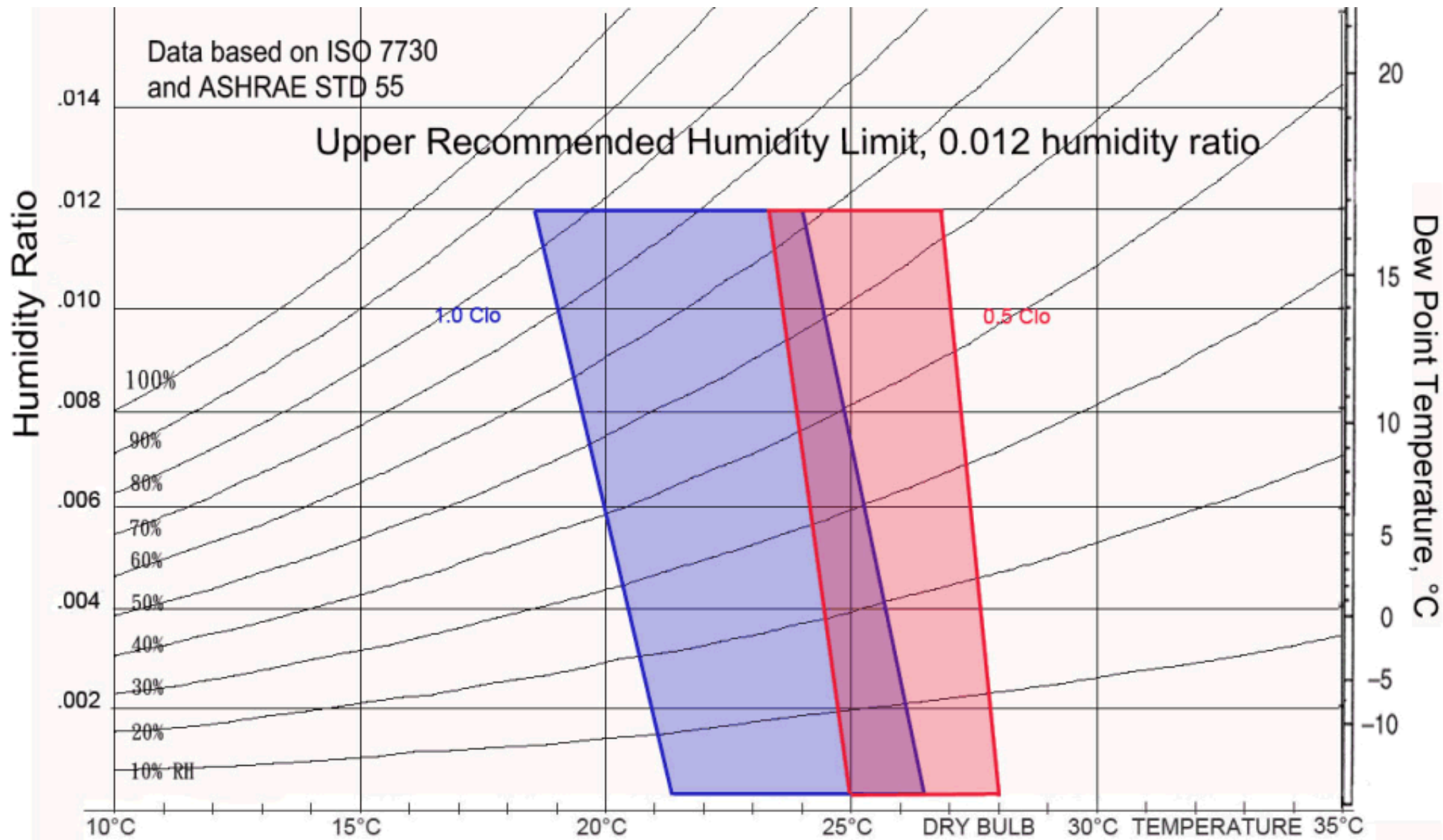



Indoor Design Conditions

- Indoor air quality: (for health & well-being)
 - Air contaminants
 - e.g. particulates, VOC, radon, bioeffluents
 - Outdoor ventilation rate provided
 - ASHRAE Standard 62.1
 - Air cleanliness (e.g. for processing), air movement
- Other design parameters:
 - Sound level (noise criteria)
 - Pressure differential between the space & surroundings (e.g. +ve to prevent infiltration)

| Type of area | Recommended NC or RC range (dB) |
|--------------------|---------------------------------|
| Hotel guest rooms | 30–35 |
| Office | |
| Private | 30–35 |
| Conference | 25–30 |
| Open | 30–35 |
| Computer equipment | 40–45 |
| Hospital, private | 25–30 |
| Churches | 25–30 |
| Movie theaters | 30–35 |

(NC = noise criteria; RC = room criteria)

* Remark: buildings in HK often have higher NC, say add 5-10 dB (more noisy).

Inputs for cooling load calculations

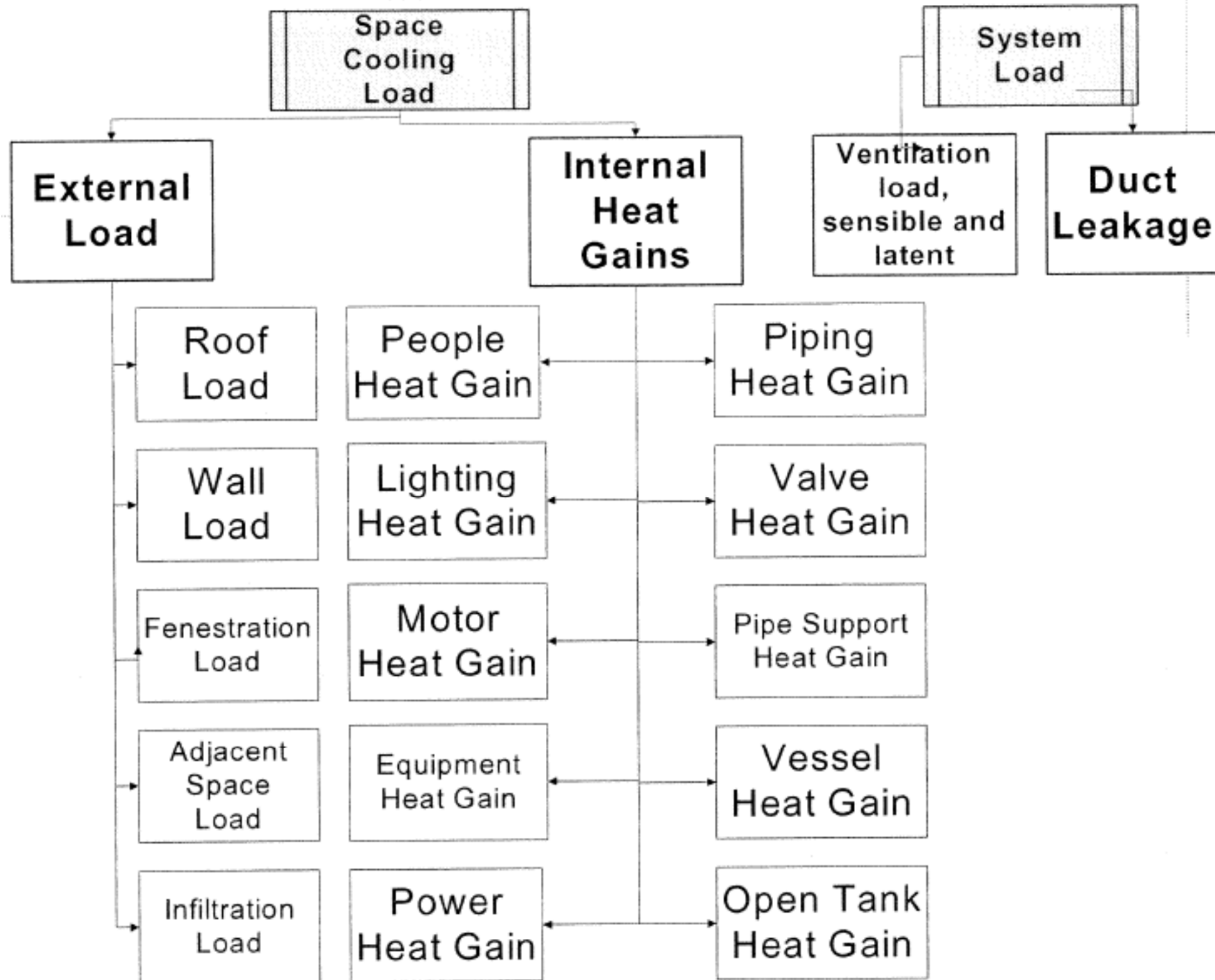

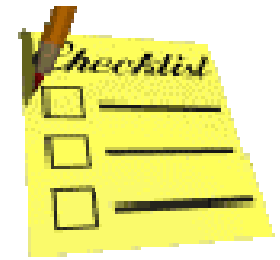

Cooling Load Components

- External

- 1. Heat gain through exterior walls and roofs
- 2. Solar heat gain through fenestrations (windows)
- 3. Conductive heat gain through fenestrations
- 4. Heat gain through partitions & interior doors

- Internal

- 1. People
- 2. Electric lights
- 3. Equipment and appliances

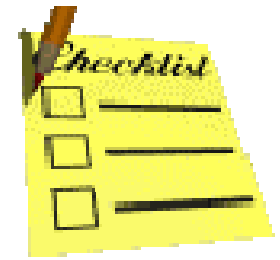

Cooling Load Components

- Infiltration
 - Air leakage and moisture migration, e.g. flow of outdoor air into a building through cracks, unintentional openings, normal use of exterior doors for entrance
- System (HVAC)
 - Outdoor ventilation air
 - System heat gain: duct leakage & heat gain, reheat, fan & pump energy, energy recovery

Components of building cooling load

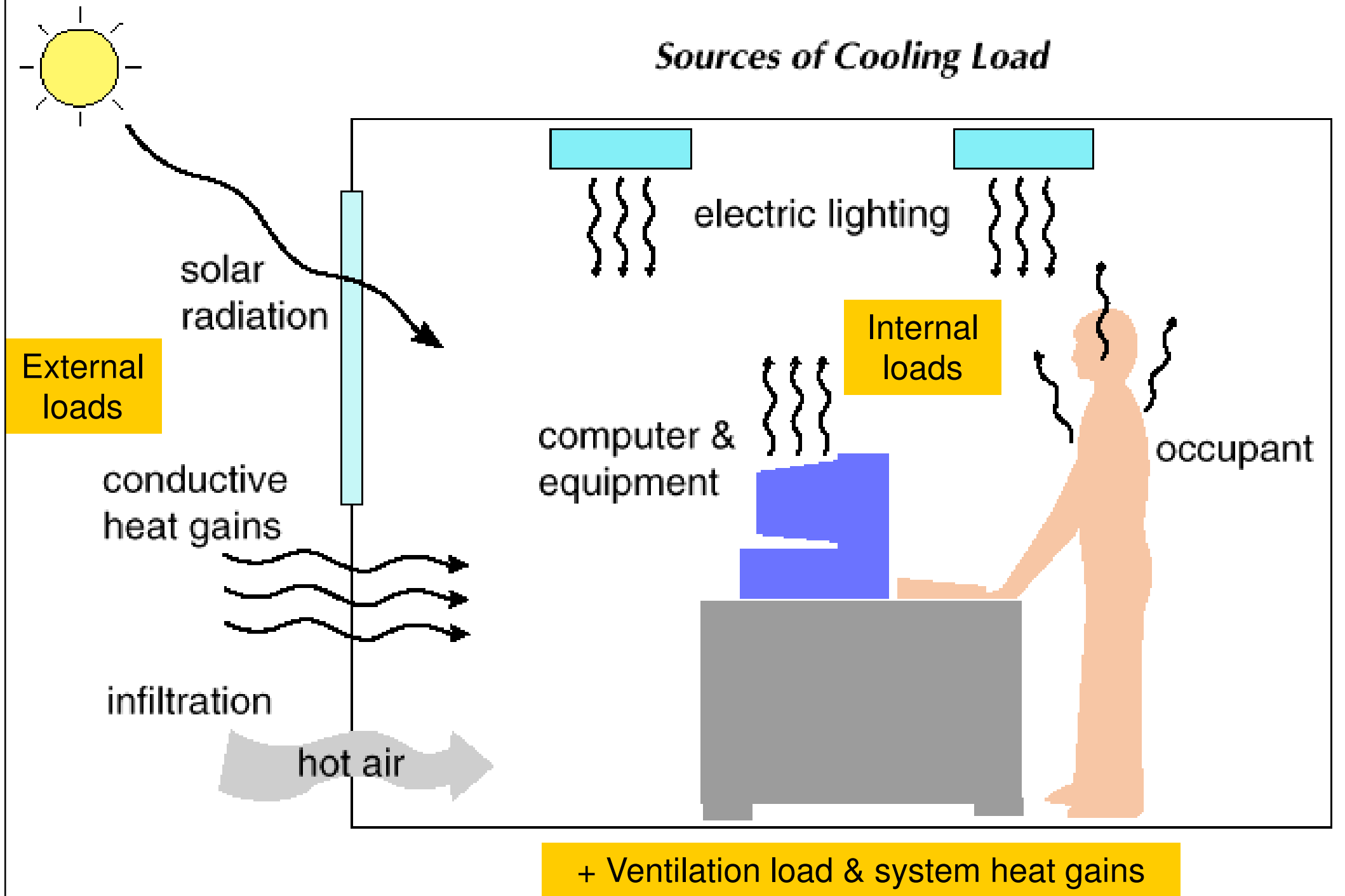

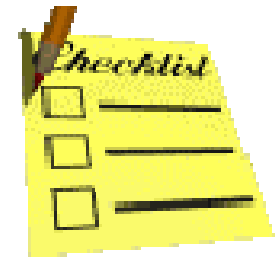

Cooling Load Components

- Total cooling load
 - Sensible cooling load + Latent cooling load
 - = $\Sigma(\text{sensible items}) + \Sigma(\text{latent items})$
- Which components have latent loads? Which only have sensible load? Why?
- Three major parts for load calculation
 - External cooling load
 - Internal cooling load
 - Ventilation and infiltration air

Table 1 Representative Rates at Which Heat and Moisture Are Given Off by Human Beings in Different States of Activity

| Degree of Activity | | Total Heat, W | | Sensible Heat, W | Latent Heat, W | % Sensible Heat that is Radiant ^b | |
|--------------------------------------|--------------------------------|---------------|----------------------------|------------------|----------------|--|--------|
| | | Adult Male | Adjusted, M/F ^a | | | Low V | High V |
| Seated at theater | Theater, matinee | 115 | 95 | 65 | 30 | | |
| Seated at theater, night | Theater, night | 115 | 105 | 70 | 35 | 60 | 27 |
| Seated, very light work | Offices, hotels, apartments | 130 | 115 | 70 | 45 | | |
| Moderately active office work | Offices, hotels, apartments | 140 | 130 | 75 | 55 | | |
| Standing, light work; walking | Department store; retail store | 160 | 130 | 75 | 55 | 58 | 38 |
| Walking, standing | Drug store, bank | 160 | 145 | 75 | 70 | | |
| Sedentary work | Restaurant ^c | 145 | 160 | 80 | 80 | | |
| Light bench work | Factory | 235 | 220 | 80 | 140 | | |
| Moderate dancing | Dance hall | 265 | 250 | 90 | 160 | 49 | 35 |
| Walking 4.8 km/h; light machine work | Factory | 295 | 295 | 110 | 185 | | |
| Bowling ^d | Bowling alley | 440 | 425 | 170 | 255 | | |
| Heavy work | Factory | 440 | 425 | 170 | 255 | 54 | 19 |
| Heavy machine work; lifting | Factory | 470 | 470 | 185 | 285 | | |
| Athletics | Gymnasium | 585 | 525 | 210 | 315 | | |

Notes:

1. Tabulated values are based on 24°C room dry-bulb temperature. For 27°C room dry bulb, the total heat remains the same, but the sensible heat values should be decreased by approximately 20%, and the latent heat values increased accordingly.
 2. Also refer to [Table 4](#), Chapter 8, for additional rates of metabolic heat generation.
 3. All values are rounded to nearest 5 W.
- ^aAdjusted heat gain is based on normal percentage of men, women, and children for the application listed, with the postulate that the gain from an adult female is

85% of that for an adult male, and that the gain from a child is 75% of that for an adult male.

^bValues approximated from data in [Table 6](#), Chapter 8, where v is air velocity with limits shown in that table.

^cAdjusted heat gain includes 18 W for food per individual (9 W sensible and 9 W latent).

^dFigure one person per alley actually bowling, and all others as sitting (117 W) or standing or walking slowly (231 W).

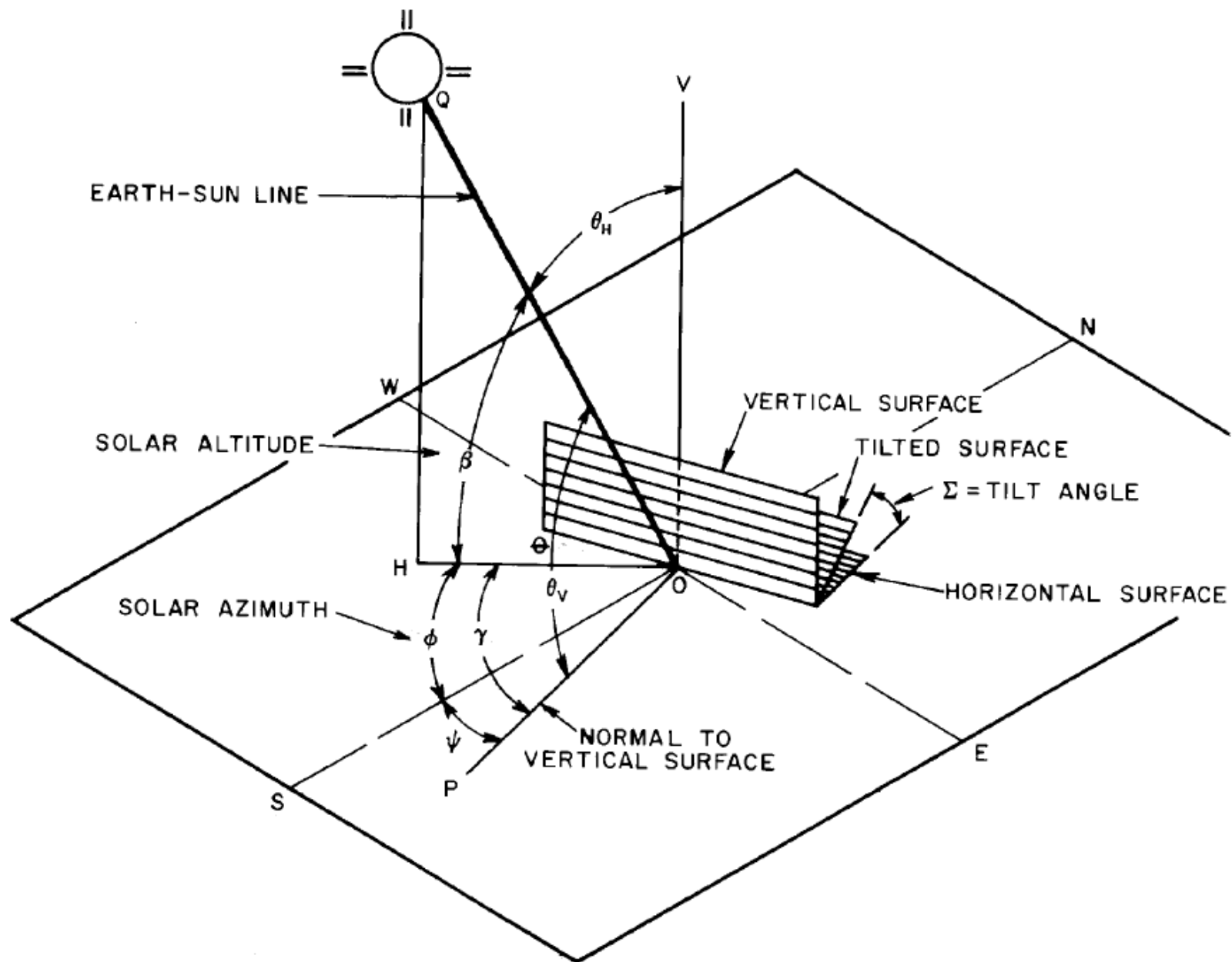

Fig. 10 Solar Angles for Vertical and Horizontal Surfaces

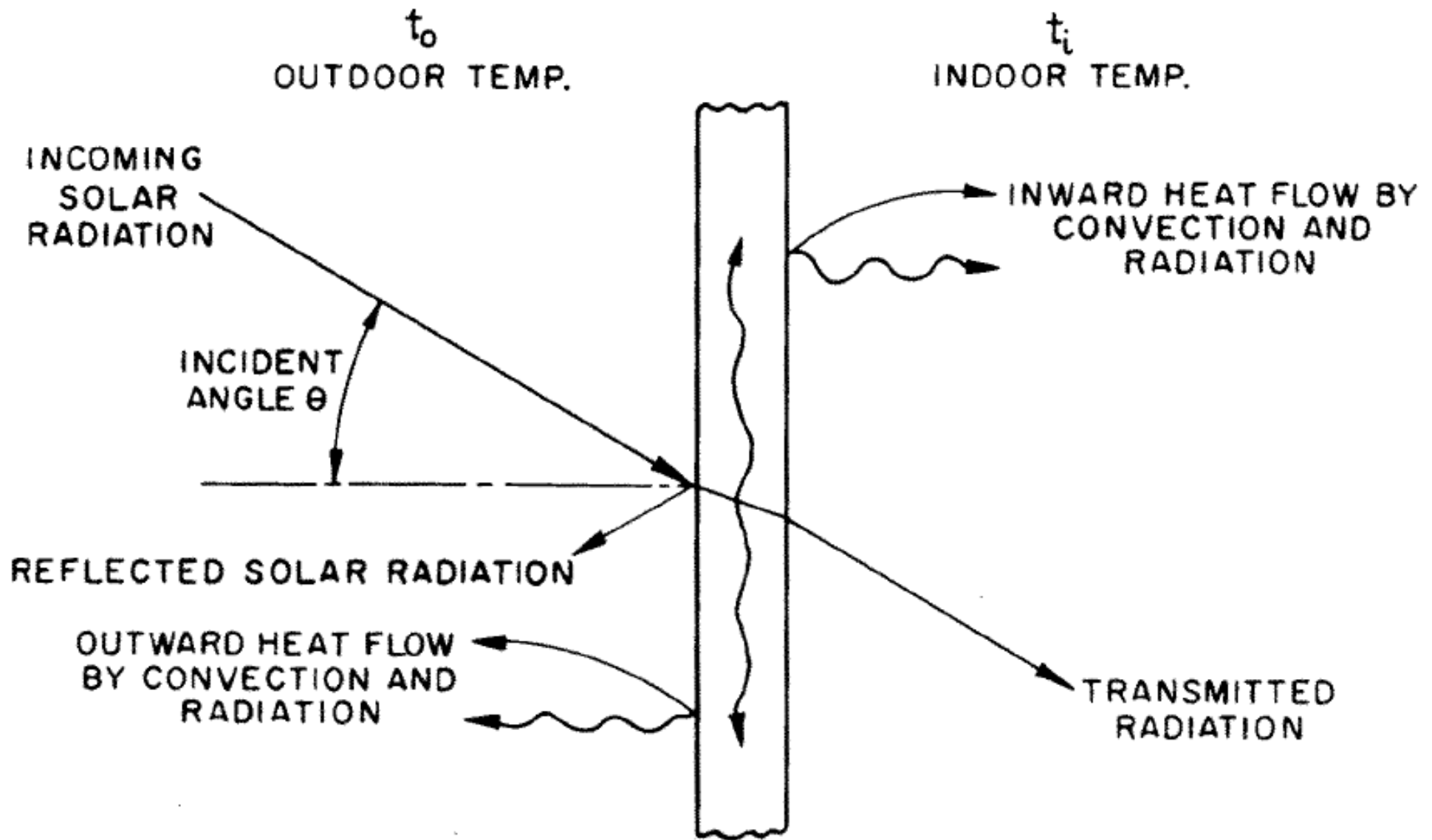
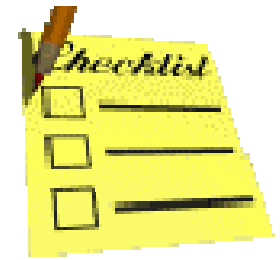
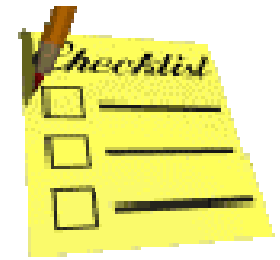

Fig. 26 Instantaneous Heat Balance for Sunlit Glazing Material



Cooling Load Components

- Cooling load calculation method
 - Example: CLTD/SCL/CLF method
 - It is a one-step, simple calculation procedure developed by ASHRAE
 - CLTD = cooling load temperature difference
 - SCL = solar cooling load
 - CLF = cooling load factor
 - See ASHRAE Handbook Fundamentals for details
 - Tables for CLTD, SCL and CLF



Cooling Load Components

- External
 - Roofs, walls, and glass conduction
 - $q = U A$ (CLTD) $U =$ U-value; $A =$ area
 - Solar load through glass
 - $q = A$ (SC) (SCL) SC = shading coefficient
 - For unshaded area and shaded area
 - Partitions, ceilings, floors
 - $q = U A (t_{\text{adjacent}} - t_{\text{inside}})$

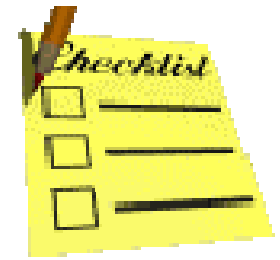

Cooling Load Components

- Internal
 - People
 - $q_{\text{sensible}} = N$ (Sensible heat gain) (CLF)
 - $q_{\text{latent}} = N$ (Latent heat gain)
 - Lights
 - $q = \text{Watt} \times F_{\text{ul}} \times F_{\text{sa}}$ (CLF)
 - F_{ul} = lighting use factor; F_{sa} = special allowance factor
 - Appliances
 - $q_{\text{sensible}} = q_{\text{input}} \times \text{usage factors}$ (CLF)
 - $q_{\text{latent}} = q_{\text{input}} \times \text{load factor}$ (CLF)

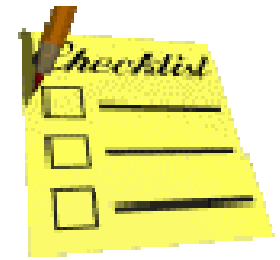

Cooling Load Components

- Ventilation and infiltration air
 - $q_{\text{sensible}} = 1.23 Q (t_{\text{outside}} - t_{\text{inside}})$
 - $q_{\text{latent}} = 3010 Q (w_{\text{outside}} - w_{\text{inside}})$
 - $q_{\text{total}} = 1.2 Q (h_{\text{outside}} - h_{\text{inside}})$
- System heat gain
 - Fan heat gain
 - Duct heat gain and leakage
 - Ceiling return air plenum

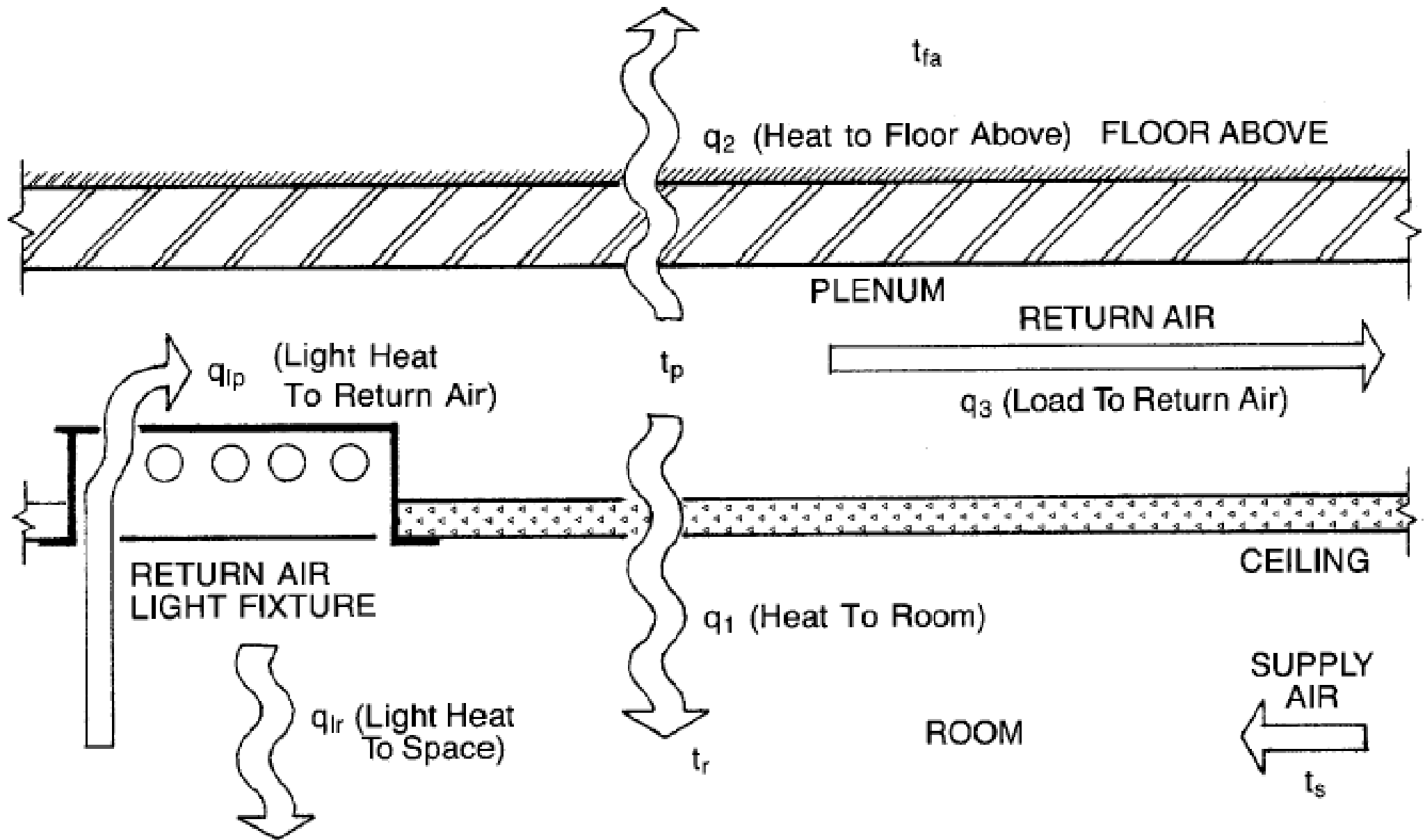

Schematic diagram of typical return air plenum

Cooling Load Principles

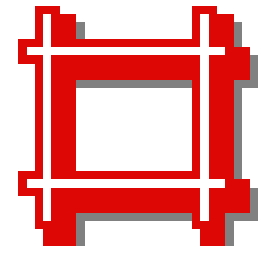

- Terminology:
 - Space – a volume w/o a partition, or a partitioned room, or group of rooms
 - Room – an enclosed space (a single load)
 - Zone – a space, or several rooms, or units of space having some sort of coincident loads or similar operating characteristics
 - Thermal zoning

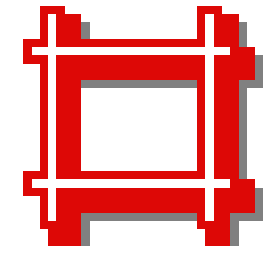

Cooling Load Principles

- Definitions
 - Space heat gain: instantaneous rate of heat gain that enters into or is generated within a space
 - Space cooling load: the rate at which heat must be removed from the space to maintain a constant space air temperature
 - Space heat extraction rate: the actual rate of heat removal when the space air temp. may swing
 - Cooling coil load: the rate at which energy is removed at a cooling coil serving the space

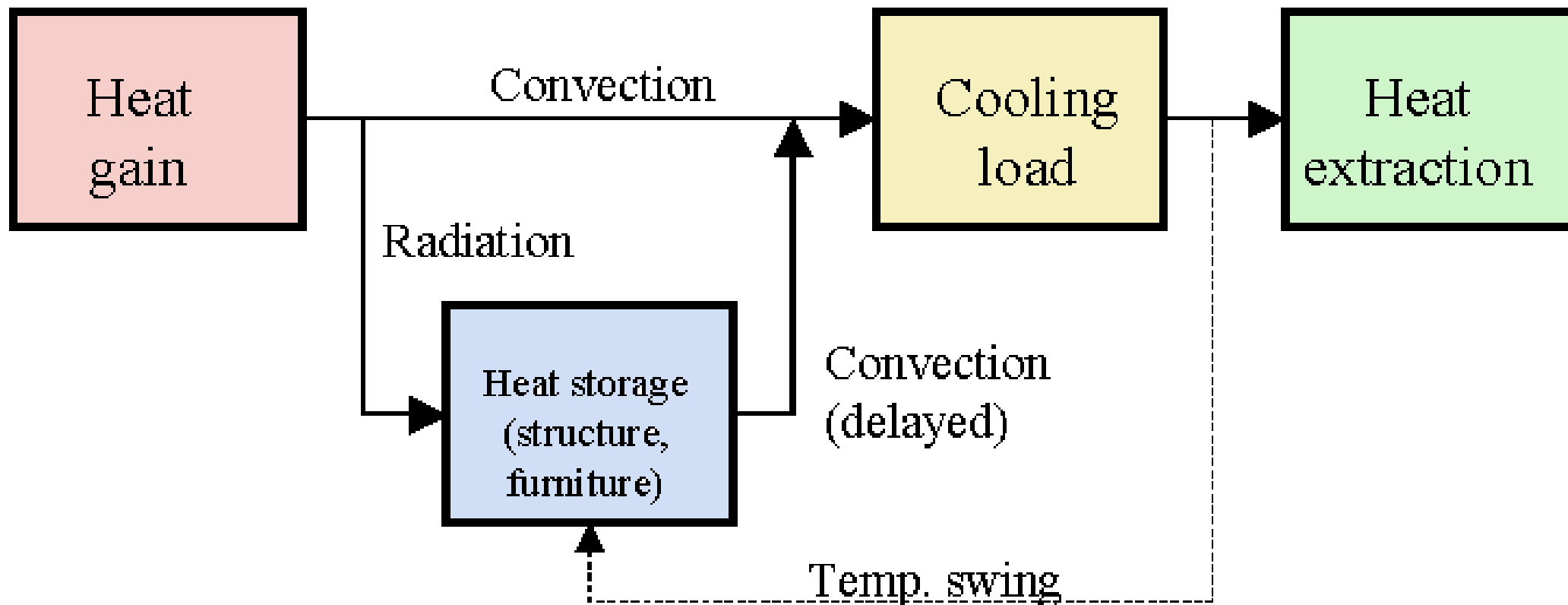

Conversion of heat gain into cooling load

Cooling Load Principles

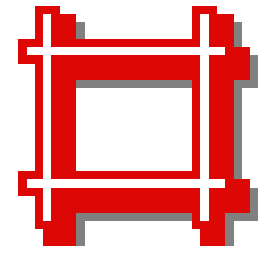

- Instantaneous heat gain vs space cooling loads
 - They are NOT the same
- Effect of heat storage
 - Night shutdown period
 - HVAC is switched off. What happens to the space?
 - Cool-down or warm-up period
 - When HVAC system begins to operate
 - Need to cool or warm the building fabric
 - Conditioning period
 - Space air temperature within the limits

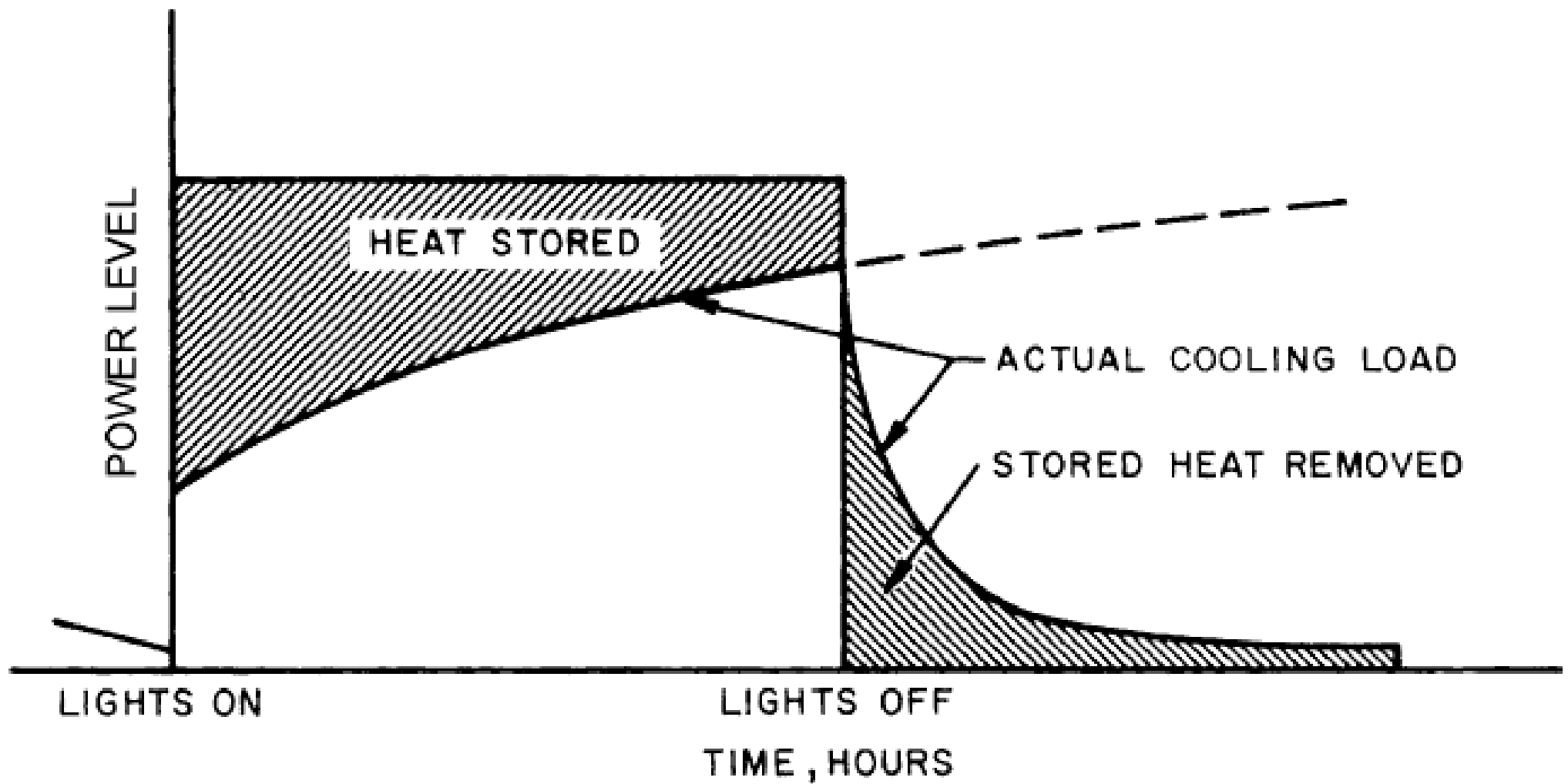

Thermal Storage Effect in Cooling Load from Lights

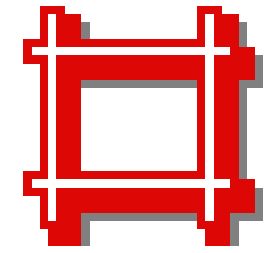

Cooling Load Principles

- Space load and equipment load
 - Space heat gain (sensible, latent, total)
 - Space cooling / heating load [*at building*]
 - Space heat extraction rate
 - Cooling / heating coil load [*at air-side system*]
 - Refrigeration load [*at the chiller plant*]
- Instantaneous heat gain
 - Convective heat
 - Radiative heat (heat absorption)

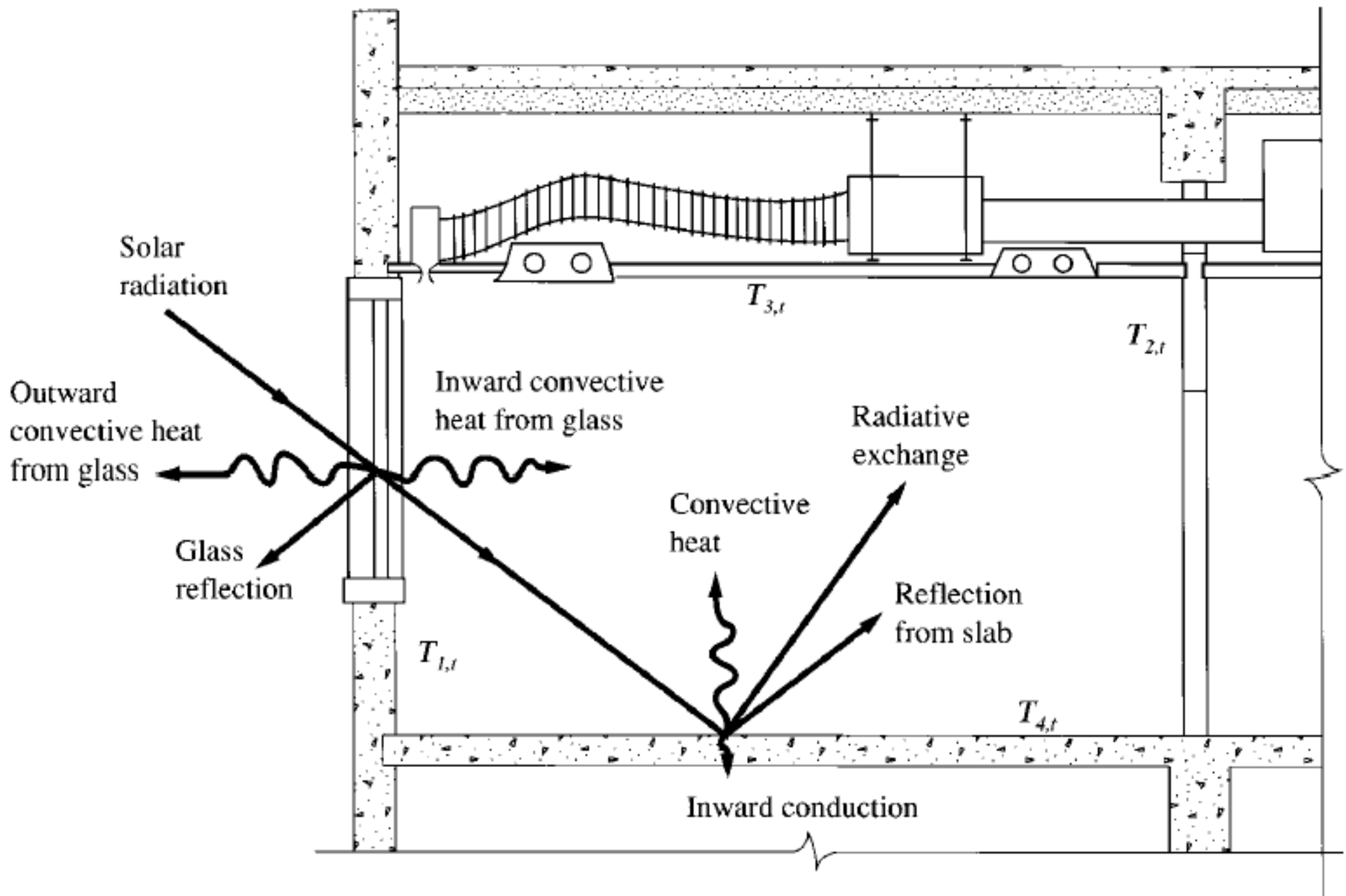

Convective and radiative heat in a conditioned space

| Sensible heat gains | Convective (%) | Radiative (%) |
|---------------------------------------|-----------------------|----------------------|
| Solar radiation with internal shading | 42 | 58 |
| Fluorescent lights | 50 | 50 |
| Occupants | 67 | 33 |
| External wall, inner surface | 40 | 60 |

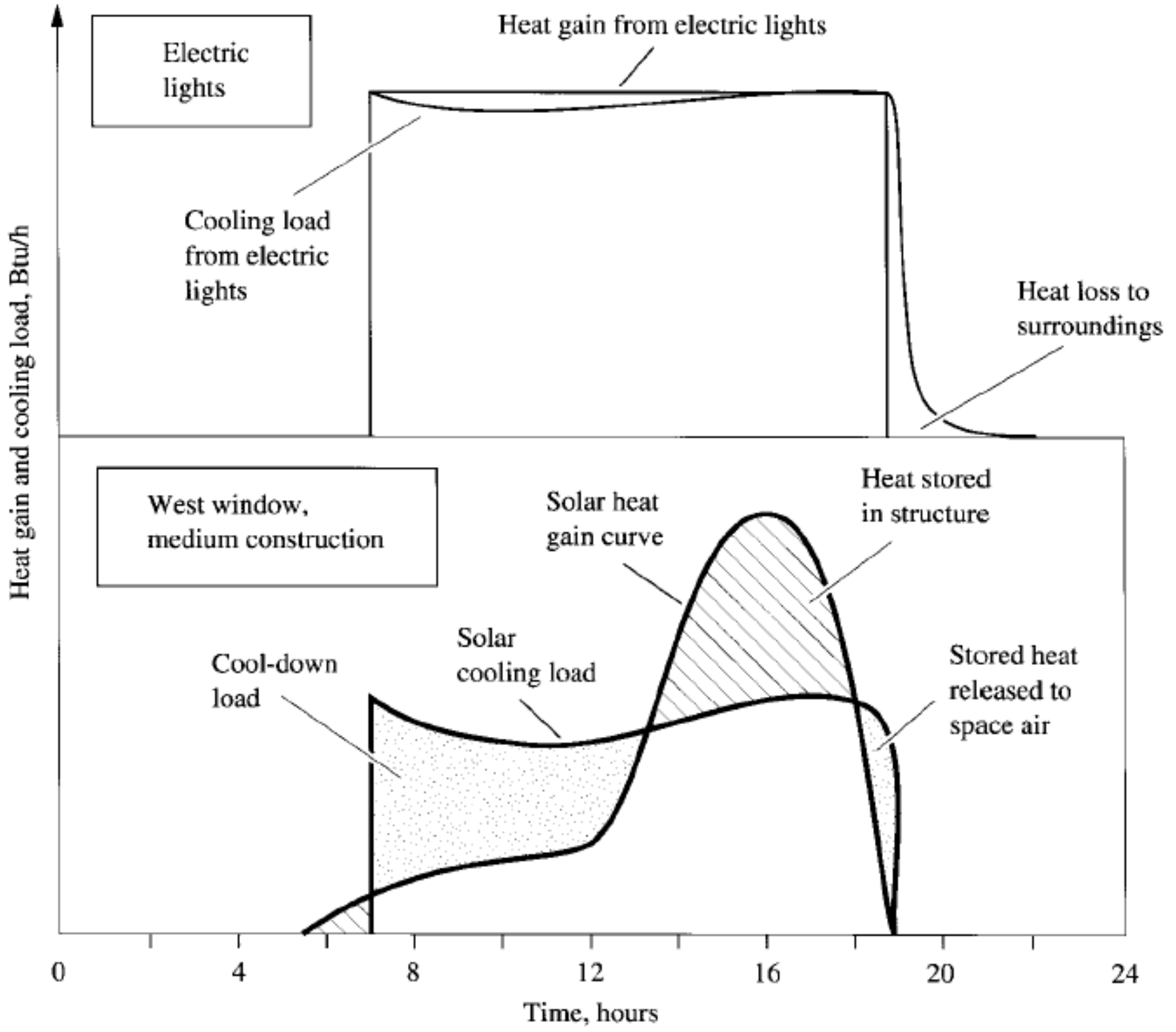

(Source: Wang, S. K., 2001. *Handbook of Air Conditioning and Refrigeration*, 2nd ed.)

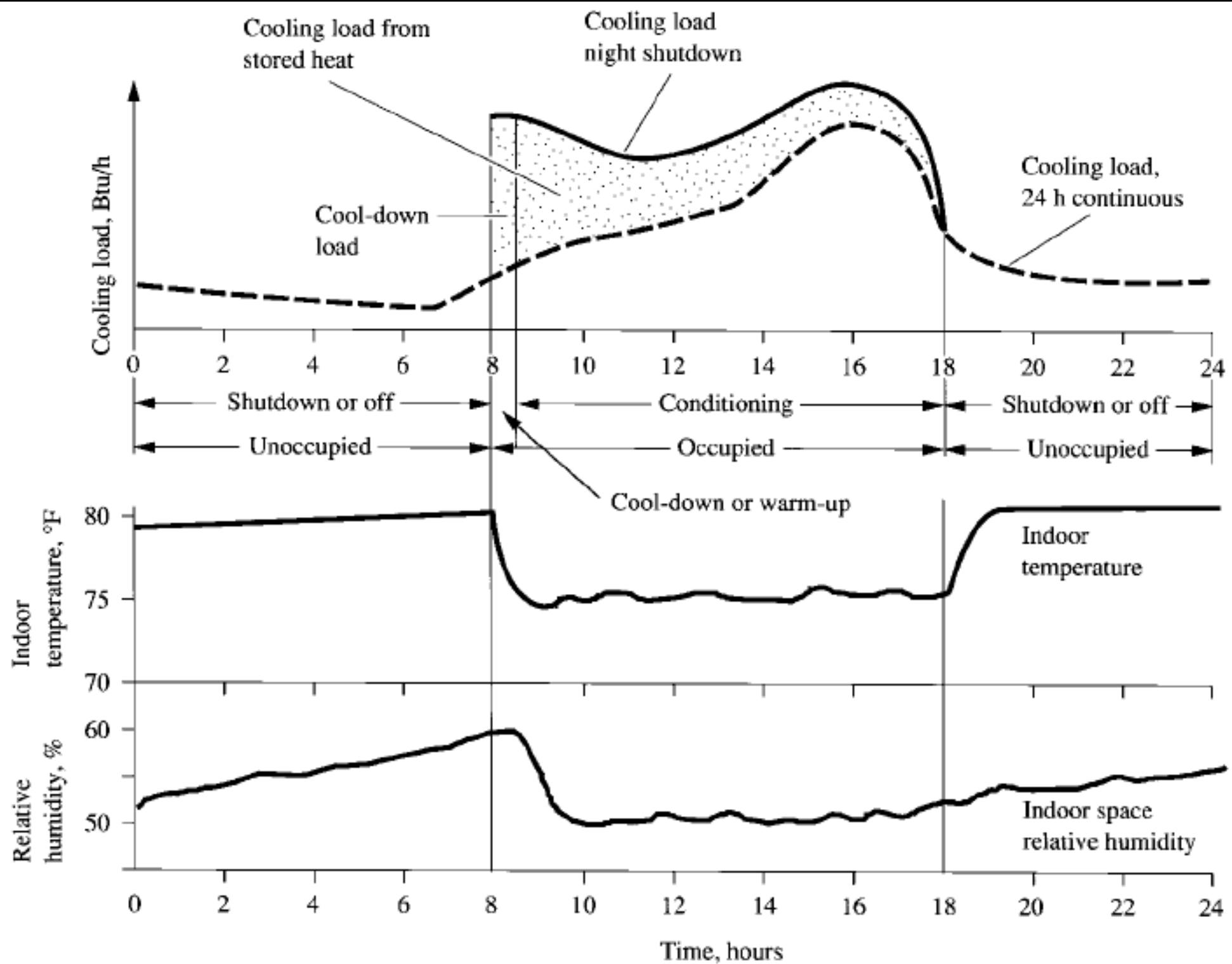

(Source: Wang, S. K., 2001. *Handbook of Air Conditioning and Refrigeration*, 2nd ed.)

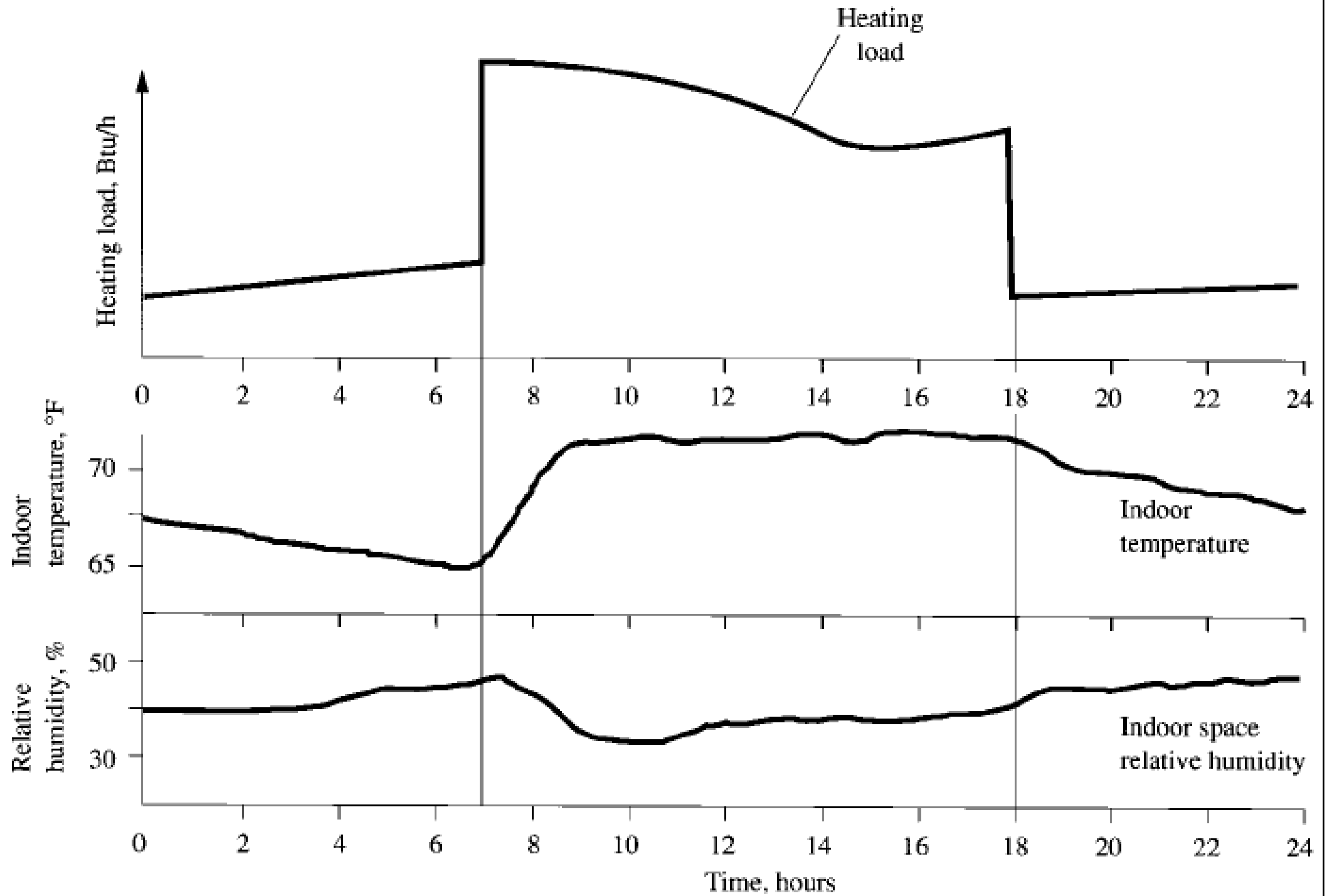

(Source: Wang, S. K., 2001. *Handbook of Air Conditioning and Refrigeration*, 2nd ed.)

Cooling Load Principles

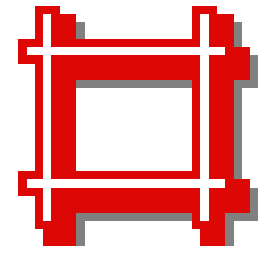

- Cooling load profiles
 - Shows the variation of space cooling load
 - Such as 24-hr cycle
 - Useful for building operation & energy analysis
 - What factors will affect load profiles?
- Peak load and block load
 - Peak load = max. cooling load
 - Block load = sum of zone loads at a specific time

Cooling load profiles

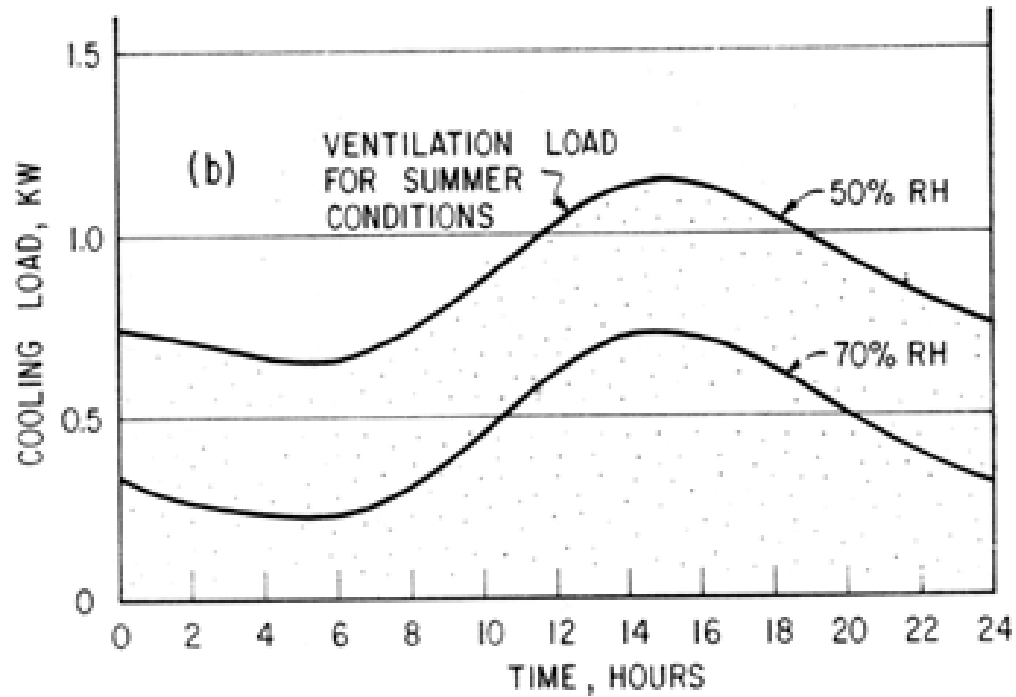
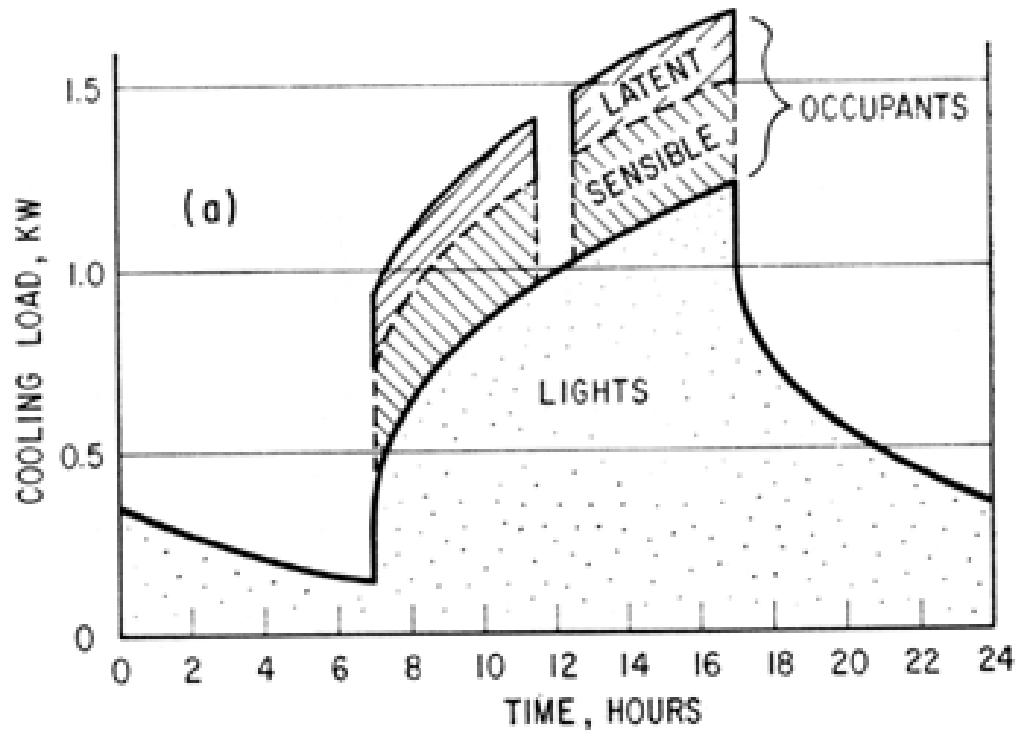

Total cooling load

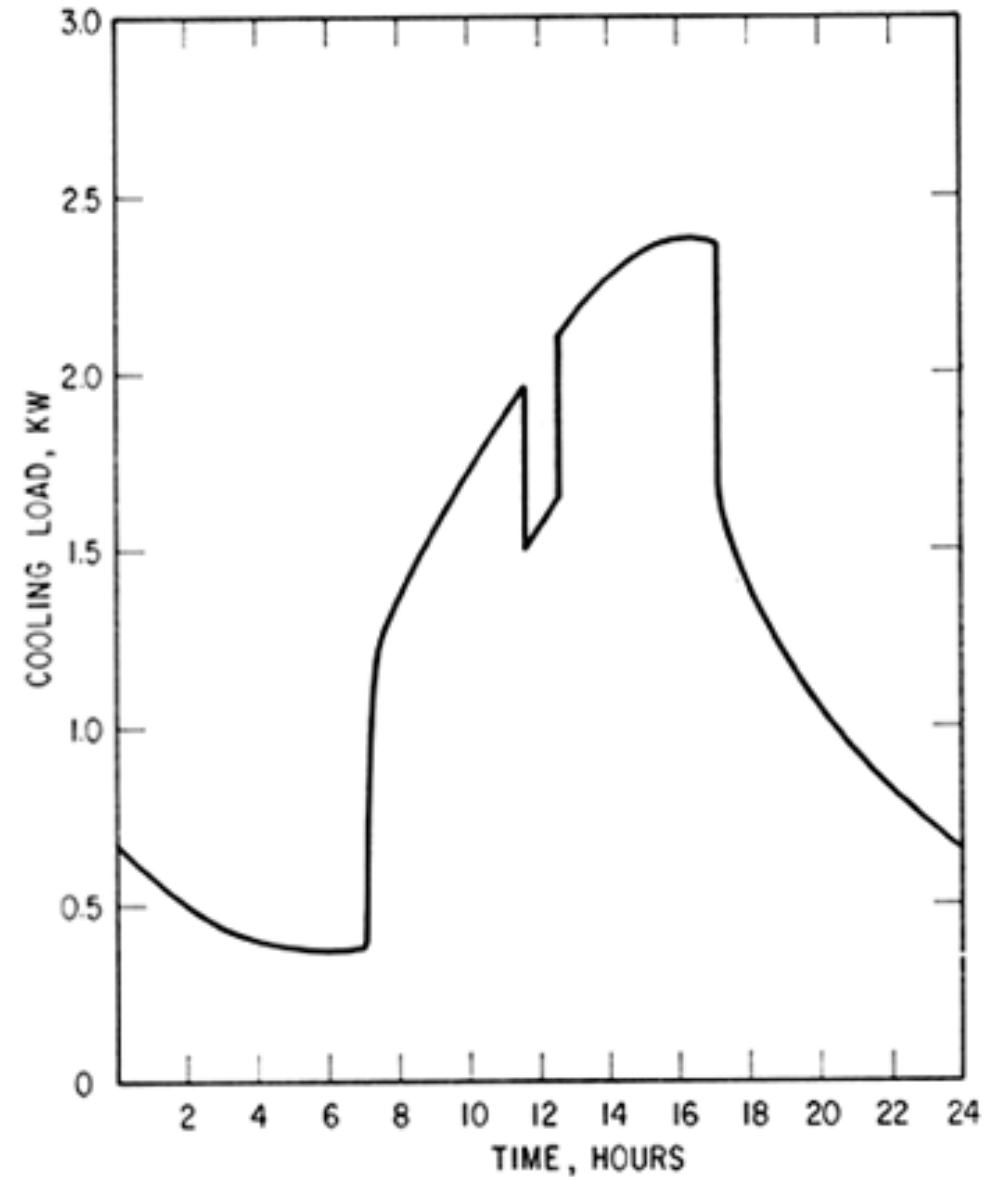

North

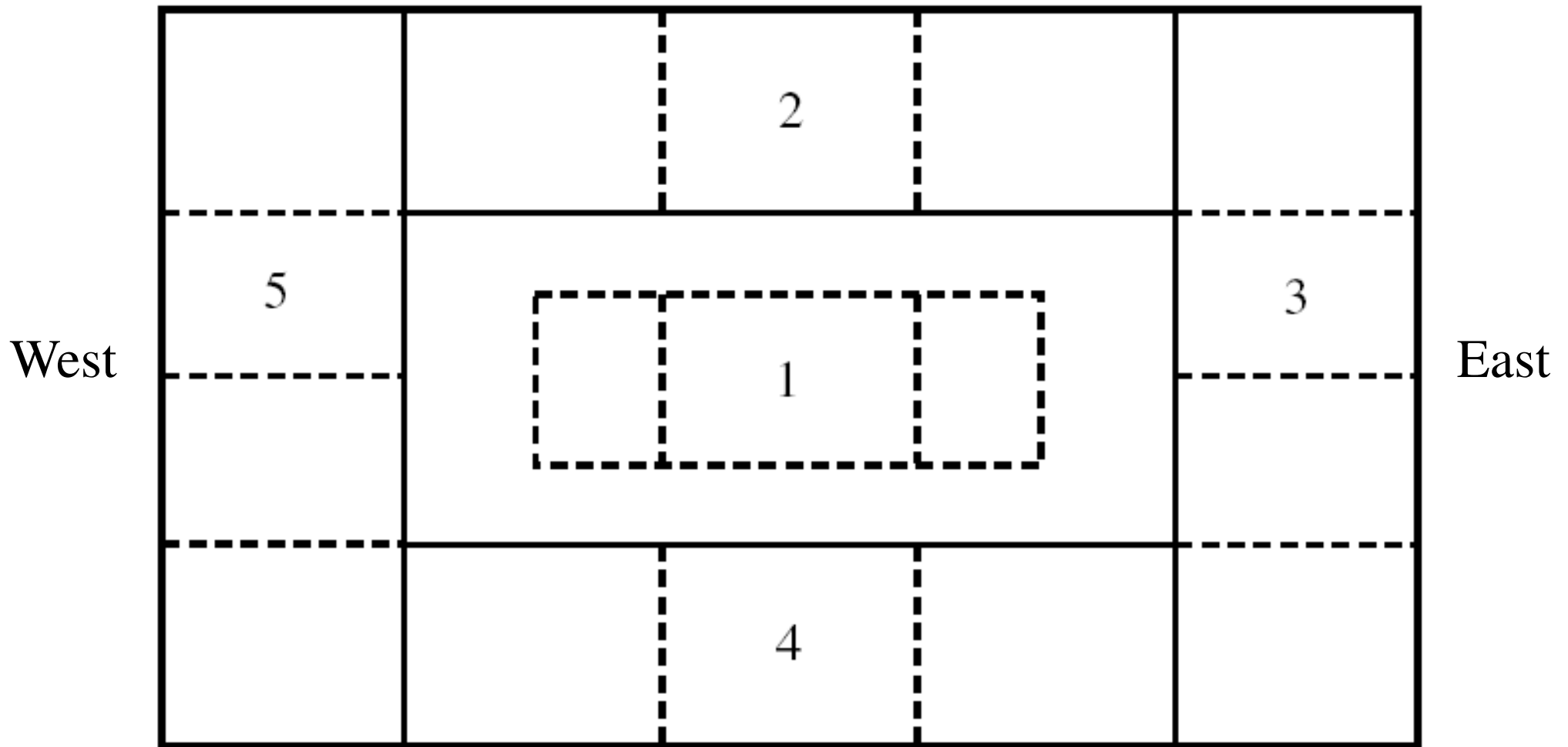

South

Block load and thermal zoning

Cooling loads due to windows at different orientations

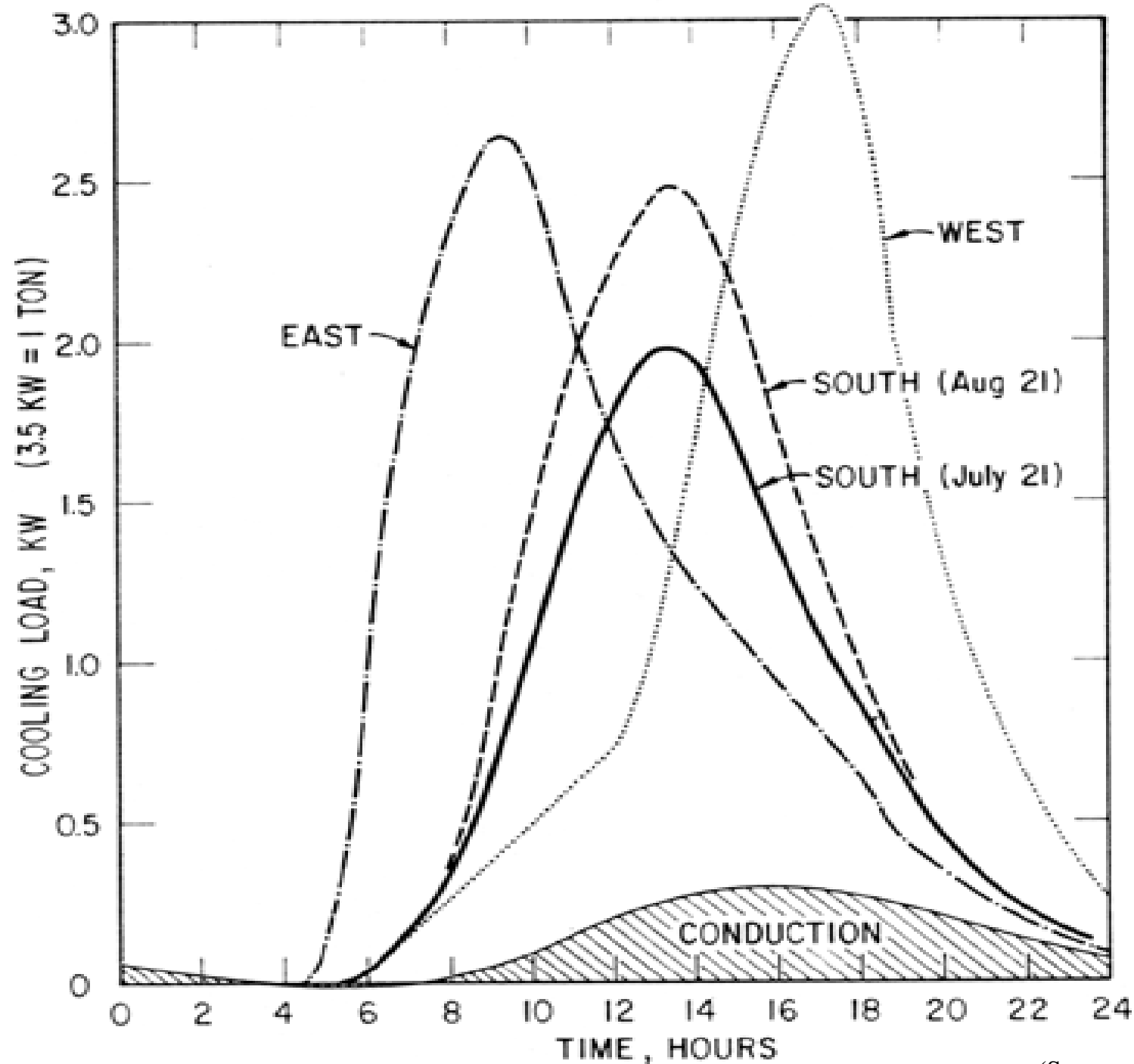

(Source: D.G. Stephenson, 1968)

Profiles of solar heat gain (July) (for latitude 48 deg N)

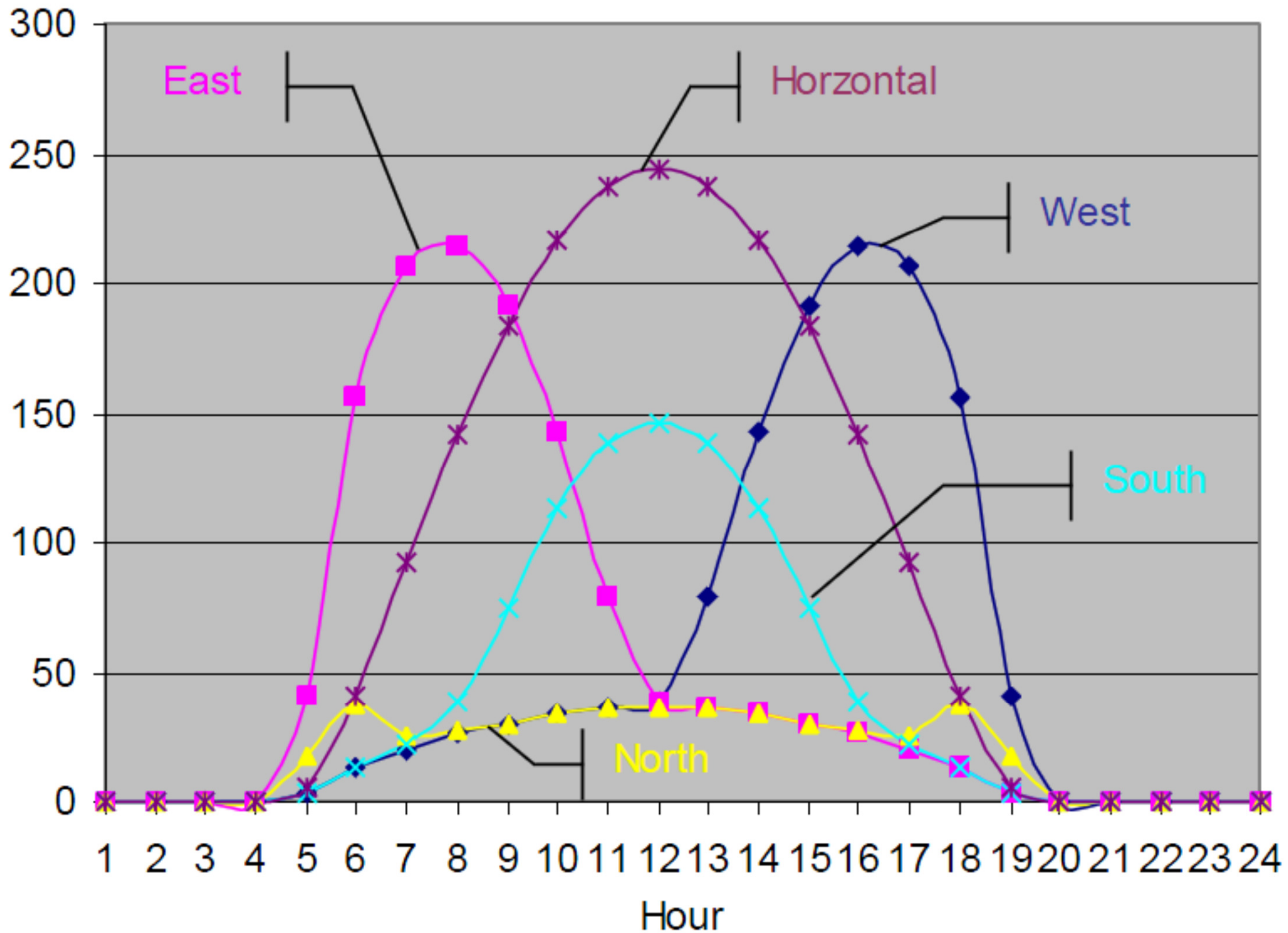

Solar cooling load vs. heat gain (July, west) (latitude 48 deg N)

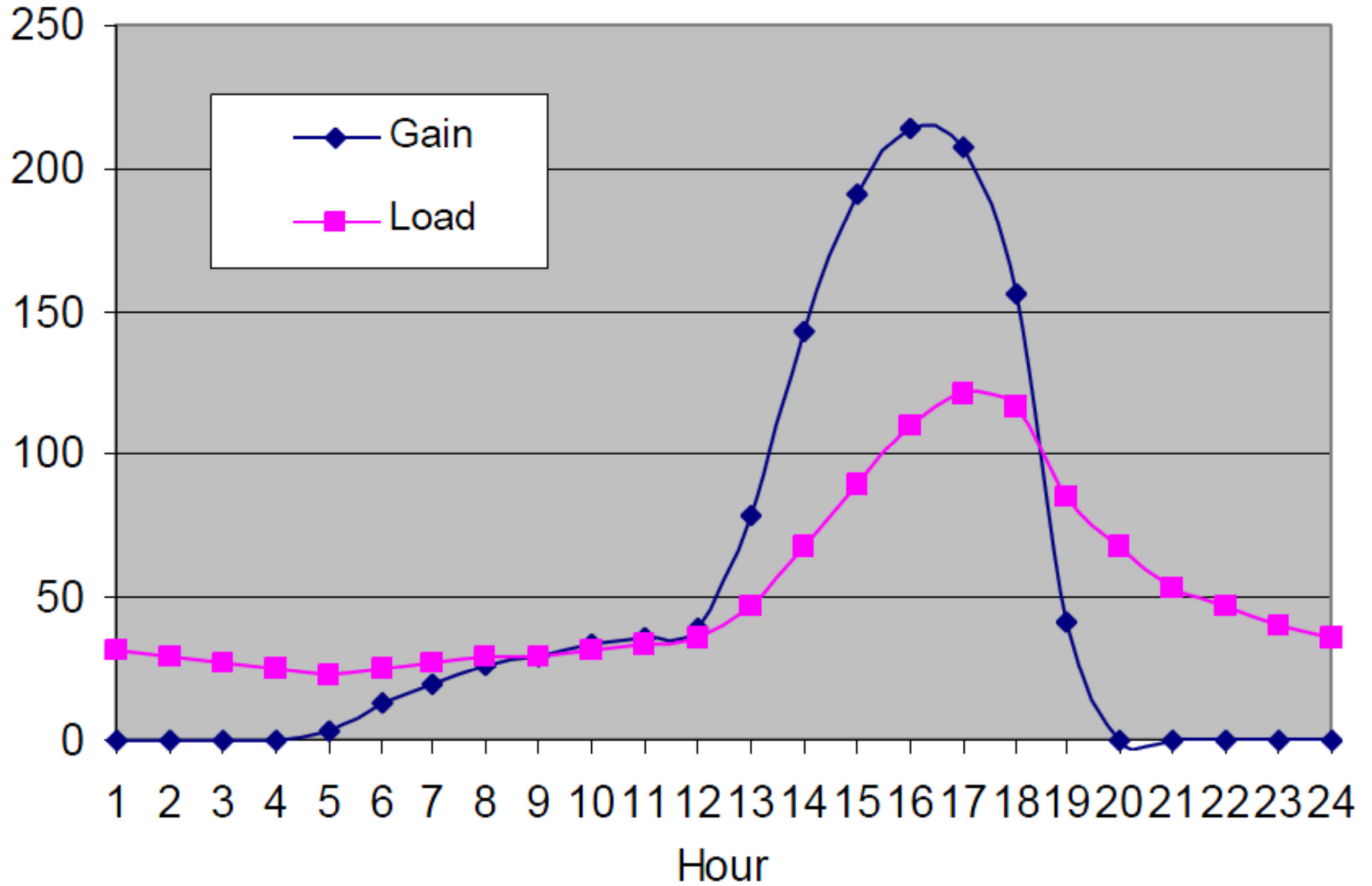

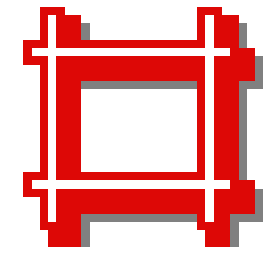

Cooling Load Principles

- Moisture transfer
 - Two paths:
 - Moisture migrates in building envelope
 - Air leakage (infiltration or exfiltration)
 - If slight RH variation is acceptable, then storage effect of moisture can be ignored
 - Latent heat gain = latent cooling load (instantaneously)
- What happens if both temp. & RH need to be controlled?

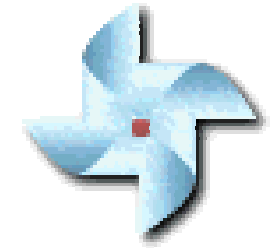

Cooling Coil Load

- Cooling coil load consists of:
 - Space cooling load (sensible & latent)
 - Supply system heat gain (fan + air duct)
 - Return system heat gain (plenum + fan + air duct)
 - Load due to outdoor ventilation rates (or ventilation load)
- Do you know how to construct a summer air conditioning cycle on a psychrometric chart?
 - See also notes in Psychrometrics

Typical summer air conditioning cycle

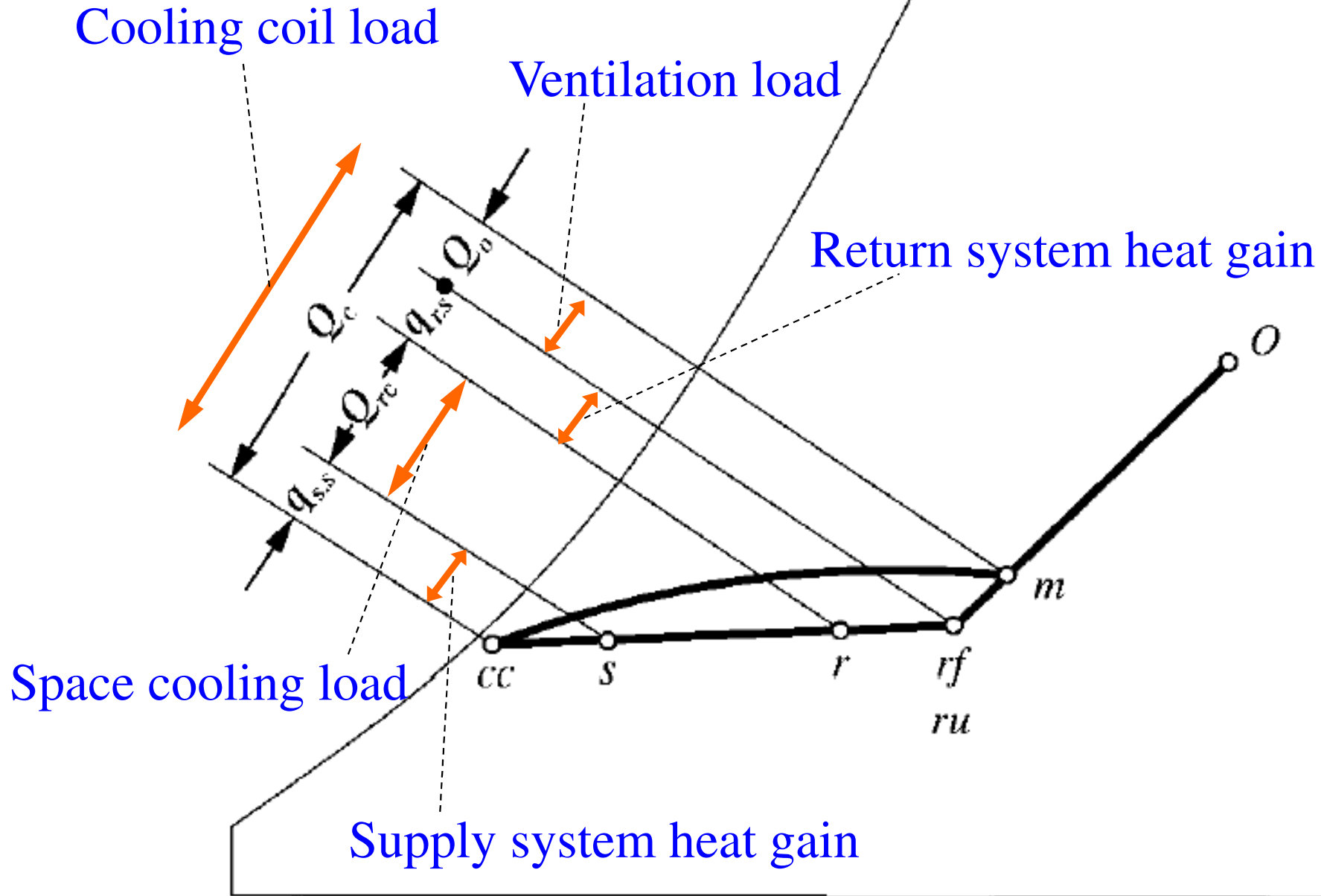

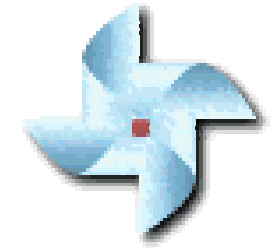

Cooling Coil Load

- Space cooling load $\text{Supply airflow (L/s)} = \frac{\text{Sensible load (kW)}}{1.2 \times \Delta t}$
 - To determine supply air flow rate & size of air system, ducts, terminals, diffusers
 - It is a component of cooling coil load
 - Infiltration heat gain is an instant. cooling load
- Cooling coil load
 - To determine the size of cooling coil & refrigeration system
 - Remember, ventilation load is a coil load

Heating Load



- Design heating load

- Max. heat energy required to maintain winter indoor design temp.
 - Usually occurs before sunrise on the coldest days
 - Include transmission losses & infiltration/ventilation
- Assumptions:
 - All heating losses are instantaneous heating loads
 - Credit for solar & internal heat gains is not included
 - Latent heat often not considered (unless w/ humidifier)
 - Thermal storage effect of building structure is ignored

Heat losses for heating load calculation

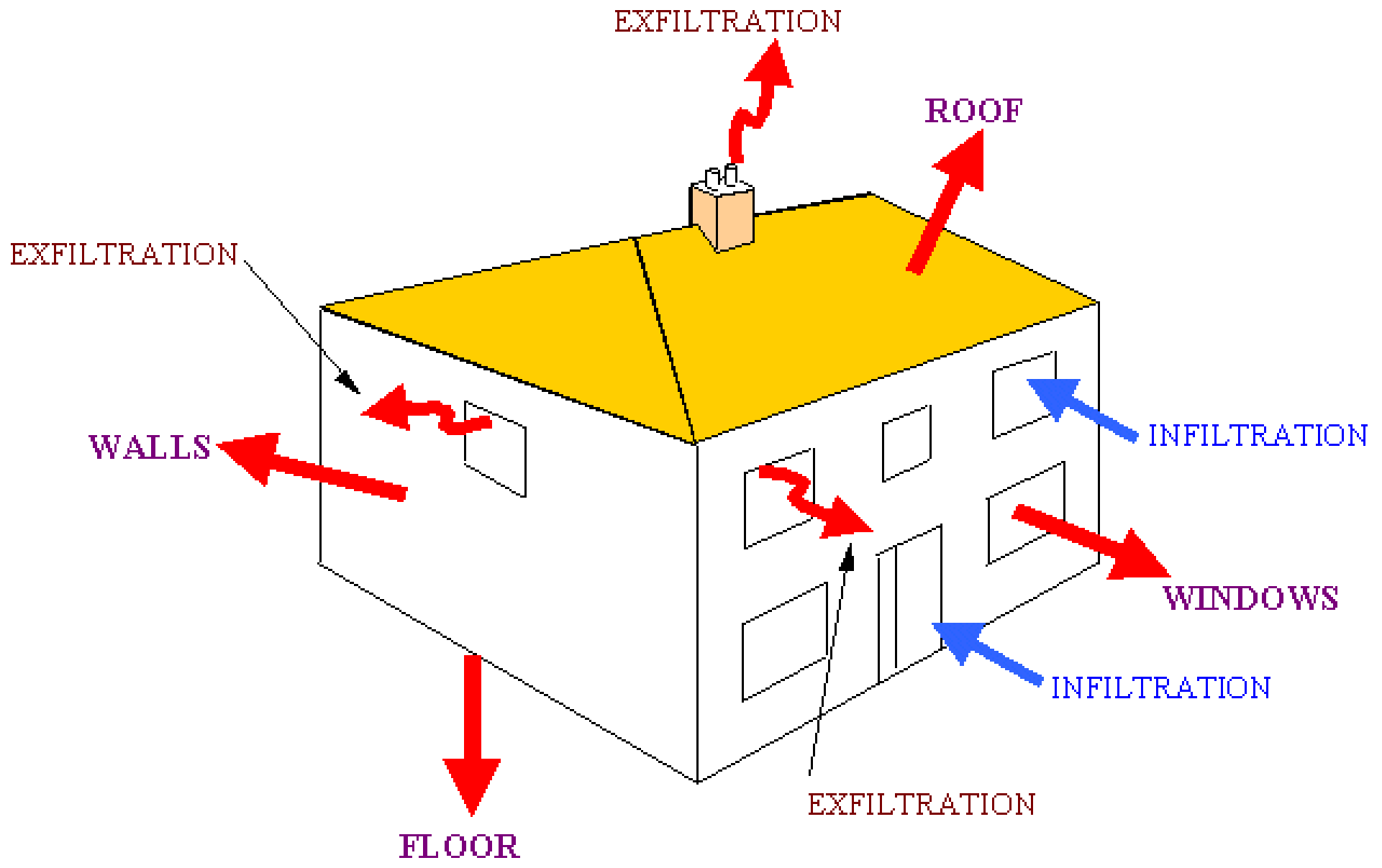

HEAT LOSS FROM A HOUSE

(Source: http://www.arca53.dsl.pipex.com/index_files/tt3.htm)

Heating Load



- A simplified approach to evaluate worst-case conditions based on
 - Design interior and exterior conditions
 - Including infiltration and/or ventilation
 - No solar effect (at night or on cloudy winter days)
 - Before the presence of people, light, and appliances has an offsetting effect
- Also, a warm-up/safety allowance of 20-25% is fairly common

Table 12 Summary of Loads, Equations, and References for Calculating Design Heating Loads

| Heating Load | Equation | Reference, Table, Description |
|----------------------------------|--------------------------|---|
| Roofs, ceilings, walls, glass | $q = U A \Delta t$ | <p>Chapter 24, Tables 1, 2, and 4</p> <p>Temperature difference between inside and outside design dry bulbs, Chapter 26. For temperatures in unheated spaces, see Equation (2); for attic temperatures, see Equation (3).</p> <p>Area calculated from plans</p> |
| Walls below grade | $q = U A \Delta t$ | <p>See Table 14.</p> <p>Use Figure 6 to assist in determining Δt.</p> |
| Floors | | |
| Above grade | $q = U A \Delta t$ | For crawl space temperatures, see Equation (4). |
| On grade | $q = F_2 P \Delta t$ | <p>See Table 16.</p> <p>See Equation (6).</p> <p>Perimeter of slab</p> |
| Below grade | $q = U A \Delta t$ | <p>Use Figure 6 to assist in determining Δt.</p> <p>See Table 15.</p> |
| Infiltration and ventilation air | | |
| Sensible | $q_s = 0.018 Q \Delta t$ | Volume of outdoor air entering building. See Chapter 25 for estimating methods for infiltration. |
| Latent | $q_t = 80.7 Q \Delta W$ | Humidity ratio difference, if humidification is to be added |

Software Applications

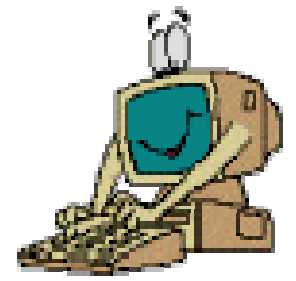

- Examples of load calculation software:
 - Carmel Loadsoft 6.0 [AV 697.00028553 L79]*
 - Commercial and industrial HVAC load calculation software based on ASHRAE 2001 Fundamentals radiant time series (RTS) method
 - Carmel Residential 5.0 [AV 697.00028553 R43]*
 - Residential and light commercial HVAC load calculation software based on ASHRAE 2001 Fundamentals residential algorithms

(* Can be found in the HKU Library.)

Software Applications

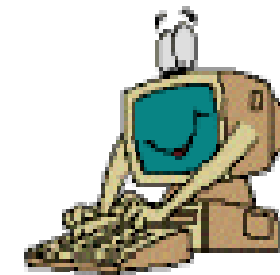

- Examples of load calculation software: (cont'd)
 - Elite Software: CHVAC and RHVAC [AV 697 E43] <http://www.elitesoft.com/> (demo version available)
 - CHVAC -- Commercial HVAC Loads
 - RHVAC – Residential HVAC Loads
 - HVAC Load Explorer (version 6)
 - http://hvac_2.okstate.edu/books/edition_6/hvac_load_6.html
 - User's Guide
<http://www.philadelphia.edu.jo/academics/sammourah/uploads/HvacLoadExplorer.pdf>

Software Applications

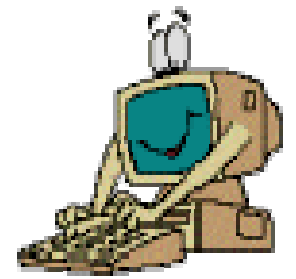

- Examples of load/energy calculation software:
 - TRACE 700
 - TRACE = Trane Air Conditioning Economics
 - Commercial programs from Trane
 - <http://www.trane.com/commercial/>
 - Most widely used by engineers in USA
 - Building load and energy analysis software
 - Carrier E20-II HAP (hourly analysis program)
 - <http://www.carrier-commercial.com/>

Further Reading

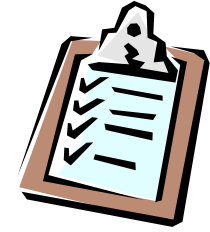

- Bruning, S. F., 2012. Load calculation spreadsheets: Quick answers without relying on rules of thumb, *ASHRAE Journal*, 54 (1): 40-46. [PDF]
- Howell, R. H., Coad, W. J. and Sauer, H. J., 2013. *Principles of Heating, Ventilating, and Air Conditioning*, 7th ed., American Society of Heating, Refrigerating and Air-Conditioning Engineers, Atlanta, GA. [ASHRAE Catalog: 697 A82 T4]
 - Chapter 4 Design Conditions
 - Chapter 5 Load Estimating Fundamentals
 - Chapter 6 Residential Cooling and Heating Load Calculations
 - Chapter 7 Nonresidential Cooling and Heating Load Calculations

Further Reading



- Cooling load calculation methods -- examples:
 - Heating & Cooling Load Calculation Form - CLTD/CLF/SCL Method (IP units) [Excel][Description: <http://www.geokiss.com/software/TideLoadInstr.pdf>]
 - Cooling load calculation of a single family house using CLTD/CLF method [PDF]
 - RTS cooling load calculations - input and results [JPG]
 - Cooling load components [JPG]
 - RTS example XLS (IP units)
http://www.hvac.okstate.edu/Software/RTS_example_Montreal_ASHRAE_Chapter_6Oct2003.xls

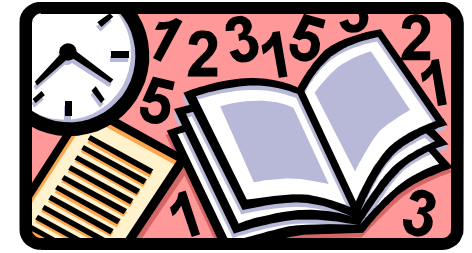

References

- Air Conditioning and Refrigeration Engineering (Wang and Norton, 2000), Chapter 6 – Load Calculations
- ASHRAE Handbook Fundamentals (2013 edition)
 - Chapter 14 – Climatic Design Information
 - Chapter 15 – Fenestration
 - Chapter 17 – Residential Cooling and Heating Load Calculations
 - Chapter 18 – Nonresidential Cooling and Heating Load Calculations
- Load Calculation Applications Manual, 2nd ed. (2014)
 - <http://www.ashrae.org/resources--publications/bookstore/load-calculation-applications-manual>

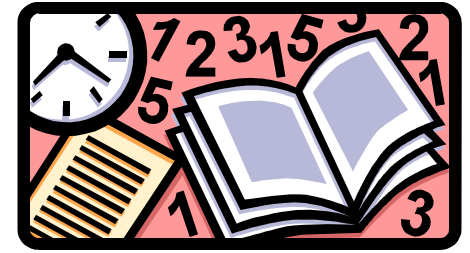

References

- Remarks:
 - “Load & Energy Calculations” in *ASHRAE Handbook Fundamentals*
 - The following previous cooling load calculations are described in earlier editions of the ASHRAE Handbook (1997 and 2001 versions)
 - CLTD/SCL/CLF method
 - TETD/TA method
 - TFM method