

Sustainable Masterplanning (II)



Ir Dr. Sam C. M. Hui

Department of Mechanical Engineering

The University of Hong Kong

E-mail: cmhui@hku.hk

Contents

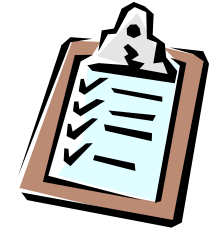

- The sustainable city
- Site planning
- Site selection and analysis
- Sustainable landscaping
- Sustainable transportation

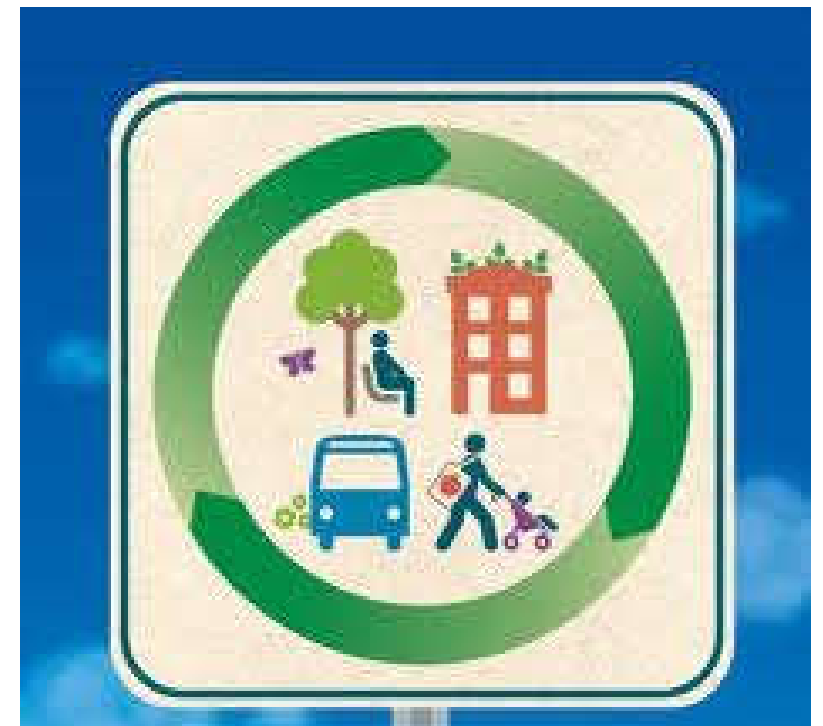



The sustainable city

- Why Urban Cities?
 - Urban population is increasing, especially in developing countries
 - Cities import energy and materials from their environment and then export back degraded energy, waste and pollution
 - Impacts of urban development (or urbanisation) are very significant and long-term
 - Economy, environment, cultural values & infrastructure

Urban and rural population by development regions (in millions)

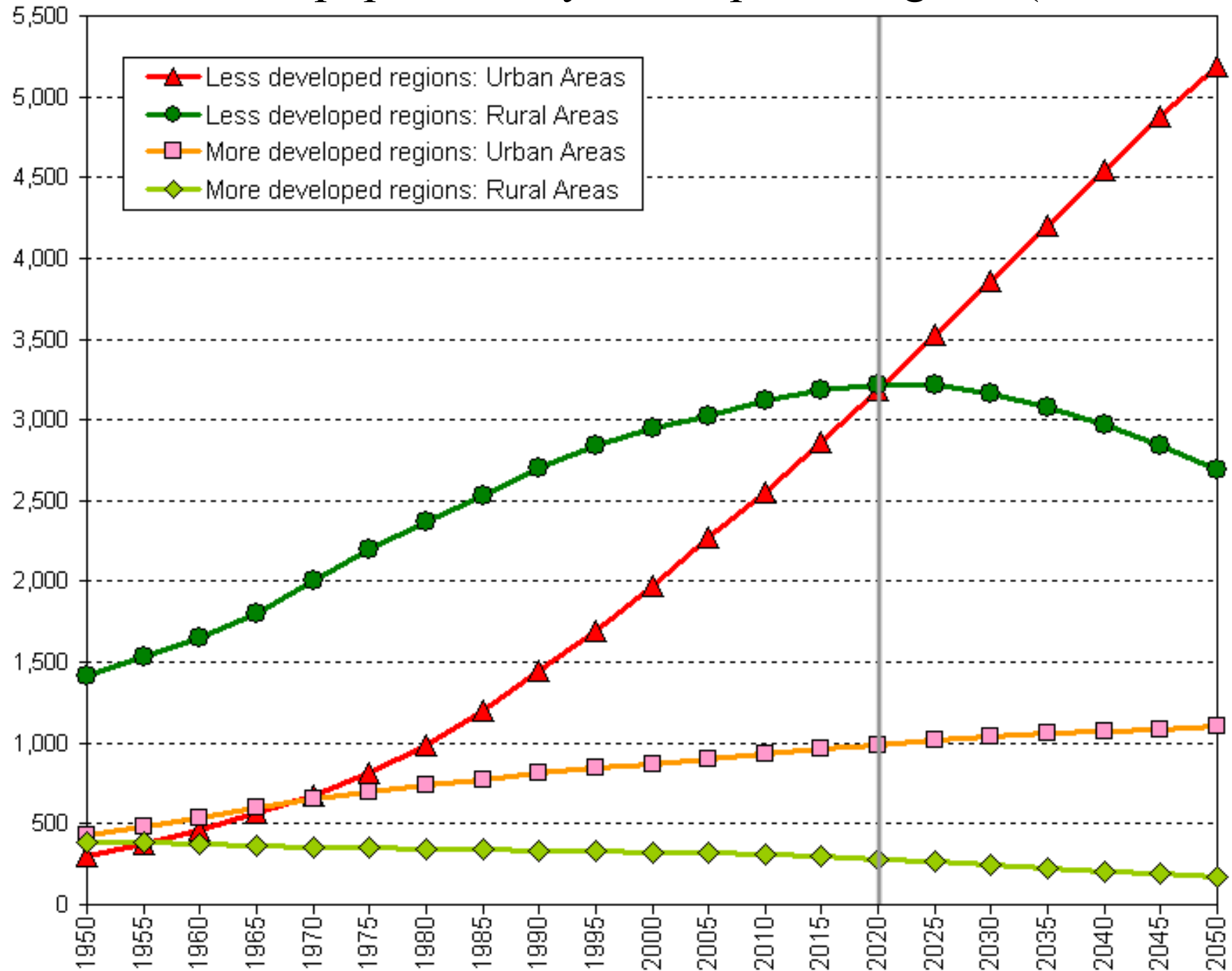

(Source: United Nations, Department of Economic and Social Affairs, Population Division, 2010. *World Urbanization Prospects, the 2009 Revision*. New York.)

Urban cities and their ecological footprints

Human needs and development

Supply ↑

Waste ↓



Supporting ecosystems and resource base

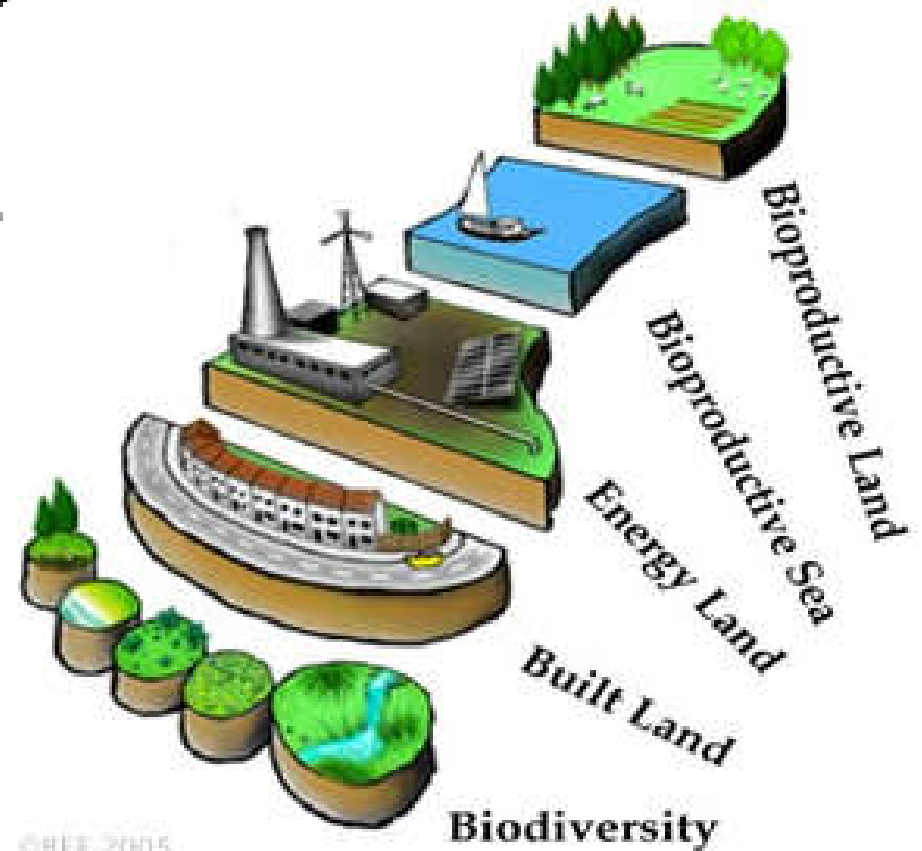
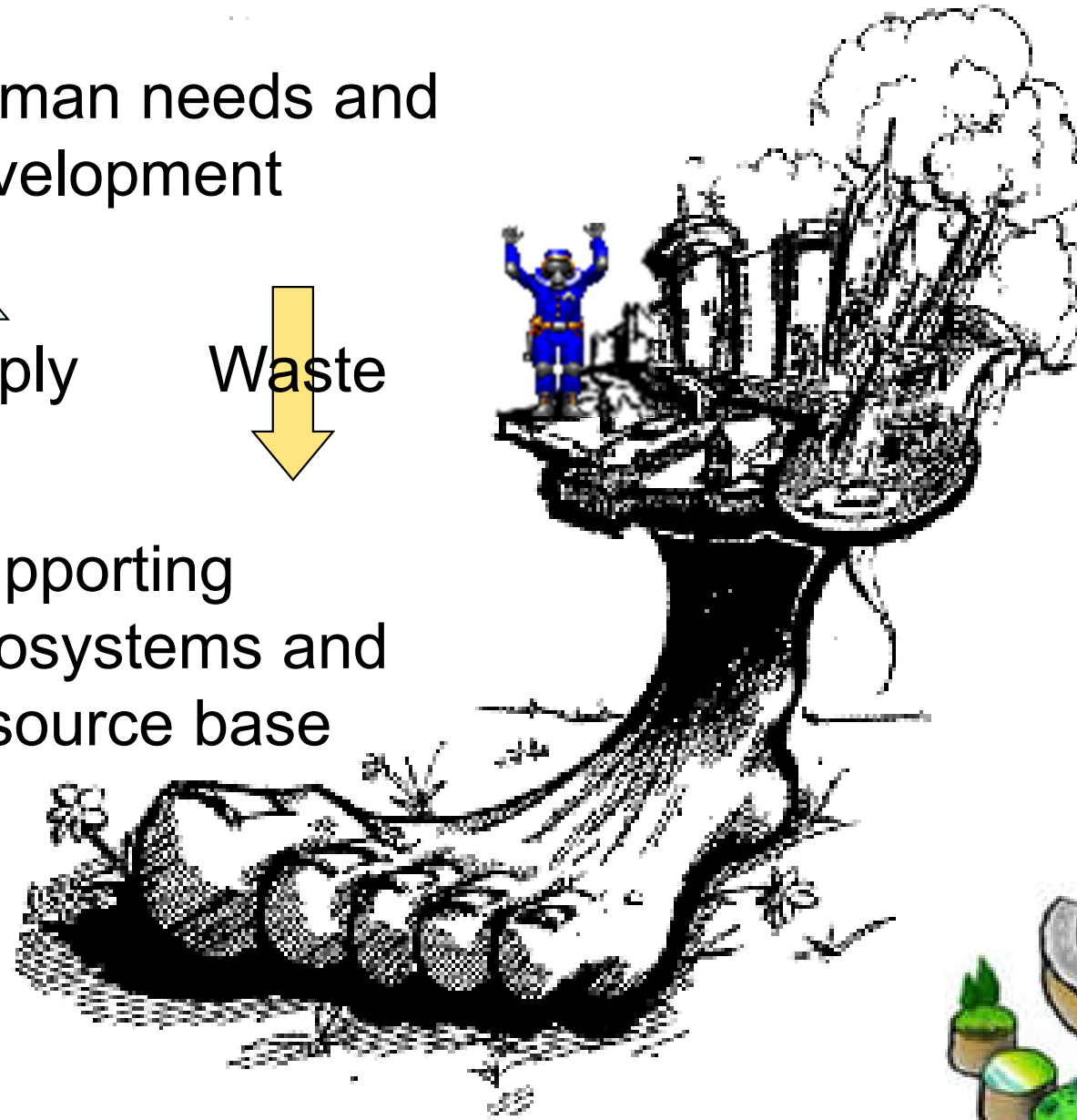

The 5 sectors of ecological footprint (for Hong Kong)

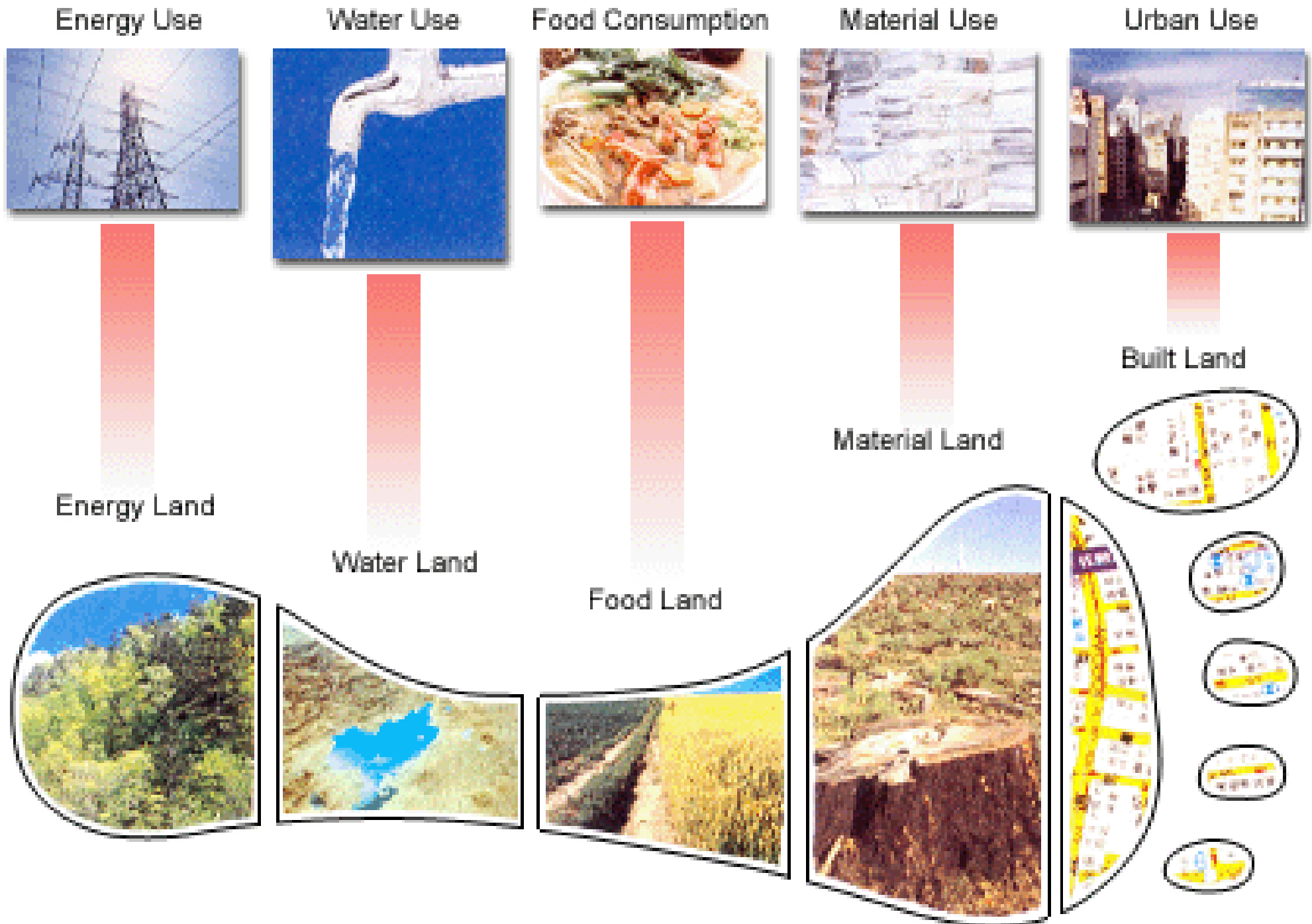



The sustainable city

- Video: Guerrilla Geography - Is Hong Kong a sustainable city? (5:05)

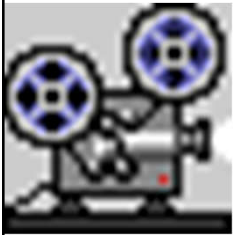

- http://youtu.be/lrKcn_CM4X4
- From a small group of International school IB Geography students...
- The impacts of the negative outputs of our city's systems - issues of air pollution as a result of the urban microclimate, leading to various health issues

Checklist for assessing impacts of urban developments

1. Local economy

- Impact on public finance
- Impact on businesses
- Impact on employment
- Change in land value
- Impact on support grants of other agencies
- Impact on land tenure

2. Local environment

- Impact on air quality
- Impact on water resources (surface/ground)
- Changes in noise & vibration
- Impact on greenbelt & open spaces
- Impact on natural habitats, species & vegetation
- Changes in land use & densities

3. Aesthetic and cultural values

- Impact on urban patterns
- Visual impacts & effects on buildings
- Impact on cultural heritage & designated areas
- Impact on amenity & personal security
- Impact on community cohesion & identity
- Impact on minority groups & equal opportunities

4. Infrastructure

- Impact on public utilities
- Impact on public services & facilities
- Impact on emergency services
- Impact on traffic conditions
- Impact on public transport
- Impact on health & safety



The sustainable city

- Major issues in urban cities
 - Traffic congestion (and also related pollution)
 - Thermal degradation (e.g. urban heat island)
 - Air pollution (e.g. smog, acidification)
 - Deterioration of indoor air quality (e.g. causing sick building syndrome)
 - Health problems (e.g. respiratory & cardiovascular disorders)
 - Noise problems



UN Environment Programme – Sustainable Liveable Cities

Sustainable Development Goal (SDG) 11: sustainable cities and human settlements

UN Environment focuses on:



Resource efficient cities

- Resource Augmentation
- Material and Energy Intensity Management
- Smart and Intelligent Cities

Approaches

- Promotion of principles Circular Economy and 3R's approaches (reduce, reuse and recycle)
- Development of lifecycle analyses
- Promotion of resource efficient smart city solutions



Clean Cities

- Pollution and Waste Prevention
- Pollution and Waste Management

- Promotion of Sustainable Consumption and Production practices to prevent unsustainable accumulation of pollution and waste
- Promotion of the Polluter Pay Principle and Extended Producer Responsibility schemes



Green and Healthy Cities

- Land-use planning for Urban Ecosystem
- Mobility Management
- Socioeconomic Equity

- Measuring and analyzing resource use in cities
- Promotion of transport planning aims to improve mobility, while reducing environmental and social impacts. This includes Just-in-Time and Intermodal Transport schemes
- Social Cents, Economic Parity, Affordability to Pay



The sustainable city

- Recommended planning strategies
 - Ecological benefits of a dense, compact city
 - Better use energy, consume fewer resources, reduce pollution and not spread over the countryside
 - More compact cities
 - Decrease the energy for transport considerably
 - Offer important economic benefits
 - Sustainable mobility
 - Transfer from cars to other more environmentally friendly modes of transport (e.g. walking, cycling, bus)





The sustainable city

- Recommended planning strategies (cont'd)
 - Making cities more liveable
 - Protect historic buildings
 - Make street the primary element of urban open space
 - Use development regulations creatively to put new buildings into context
 - Preserve a mix of different activities
 - Consider place-making as a larger social issue
 - Destruction of place may make people transient & 'rootless'





The sustainable city

- Recommended planning strategies (cont'd)

- Develop the quality of public spaces & sociability

- Enable different types of community activities

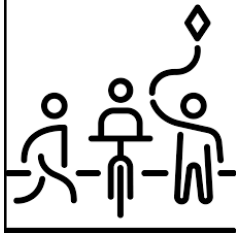

- Restore continuity of use & structure in cities

- Buildings be built to the street line
 - Ground floors on certain streets have shops in them
 - Height limits and setbacks be imposed

- Favour neighbourhood planning

- Sense of community, participation

- Increase the energy efficiency of urban systems





The sustainable city

- Design strategies
 - Create “open-minded” public spaces
 - Multi-functional, open to all
 - Order and creation of place
 - Give order & internal cohesion (linked to the past & organic growth, avoid the loss of identity)
 - Preservation of history
 - To demonstrate the ever-changing & diverse character of city life; become a historically rich place



The sustainable city

- Design strategies (cont'd)
 - Design the city parts according to a visual image of the city, e.g. by using “visual plan”
 - The inter-relationship of different parts
 - Harmonious relationship of the different parts
 - Design the image of the metropolis
 - Urban composition; fundamentally unified layout
 - The colour image of the city
 - Colour scheme to define the identity

Overall approach for a liveable high density built environment in HK

- Enhance the liveability of our high-density built environment through promoting eight city attributes
- People-centric approach focusing on social and livelihood aspects

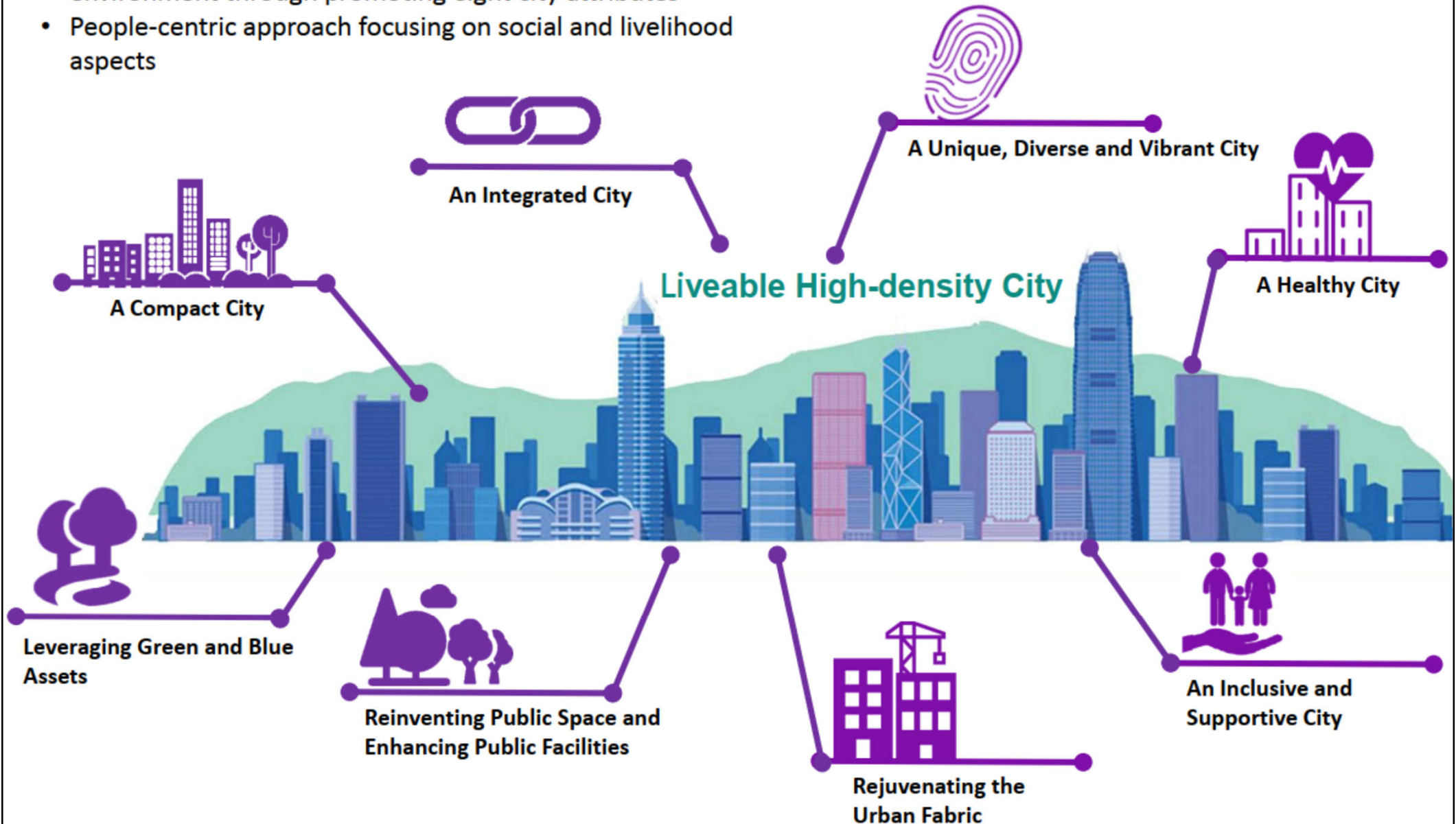

A smart, green and resilient city strategy (Hong Kong 2030+)

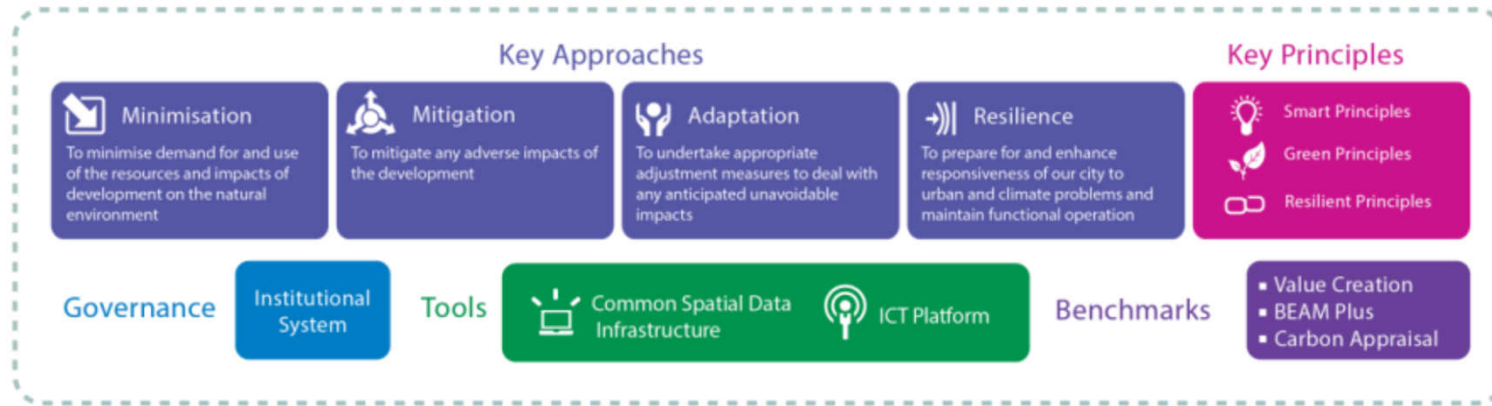



The sustainable city



- Smart, green and resilient Hong Kong for better quality living:
 - Promote sustainable planning and urban design
 - Foster smart mobility
 - Devise an integrated smart, green and resilient infrastructure system
- Set up a common spatial data infrastructure and ICT infrastructure as foundations for a smart city

6 major components of smart city

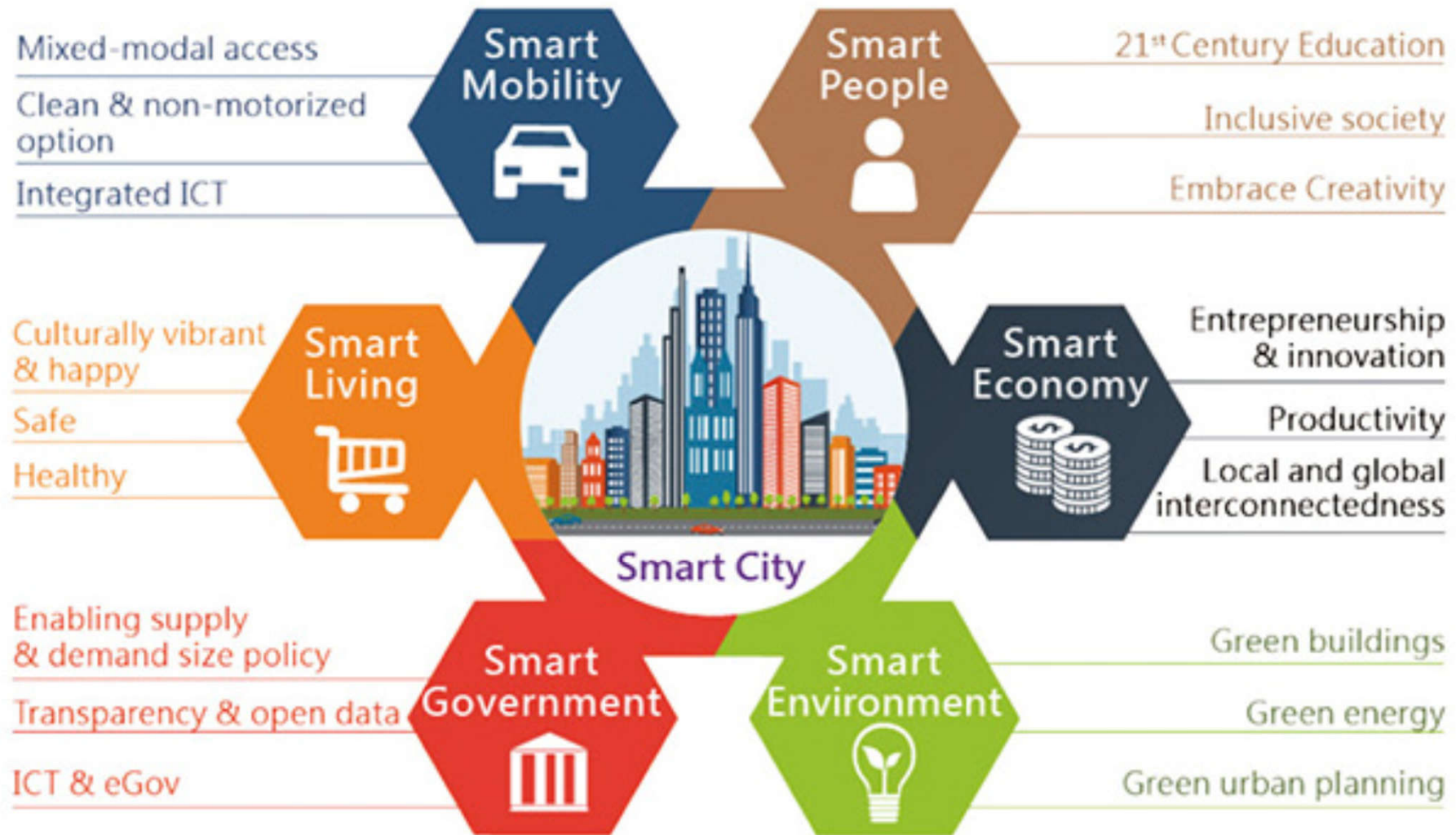

Smart City is a city which capitalises on new technologies and developments to enhance its systems, operations and service delivery. The Smart City concept embodies a focus on ICT (Information and communication technology), covers almost every aspect of society and daily life.

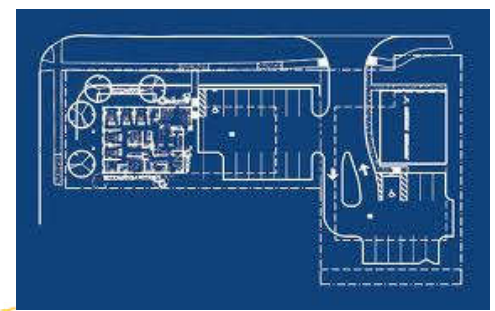

Site planning

- It is the art of arranging the external physical environment to support human behaviour
 - Site plans locate structures & activities in 3-D space and, when appropriate, in time
 - Also involve choices about where not to build
- Sustainable site planning
 - Protect & restore degraded natural & cultural resources
 - Minimise detrimental impacts of development on the environment

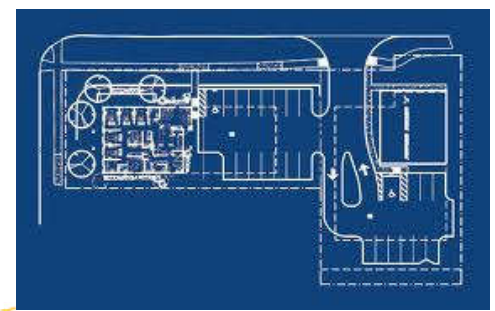

Site planning

- Site planning process
 - 1. Preproject (or Predesign) phases
 - Programming (define objectives & functional requirements)
 - 2. Site assessment phases
 - Site selection, site inventory, site analysis
 - 3. Design phases
 - Conceptual design, design development, construction documentation
 - 4. Implementation phase

Spatial hierarchy: regions, landscapes, sites

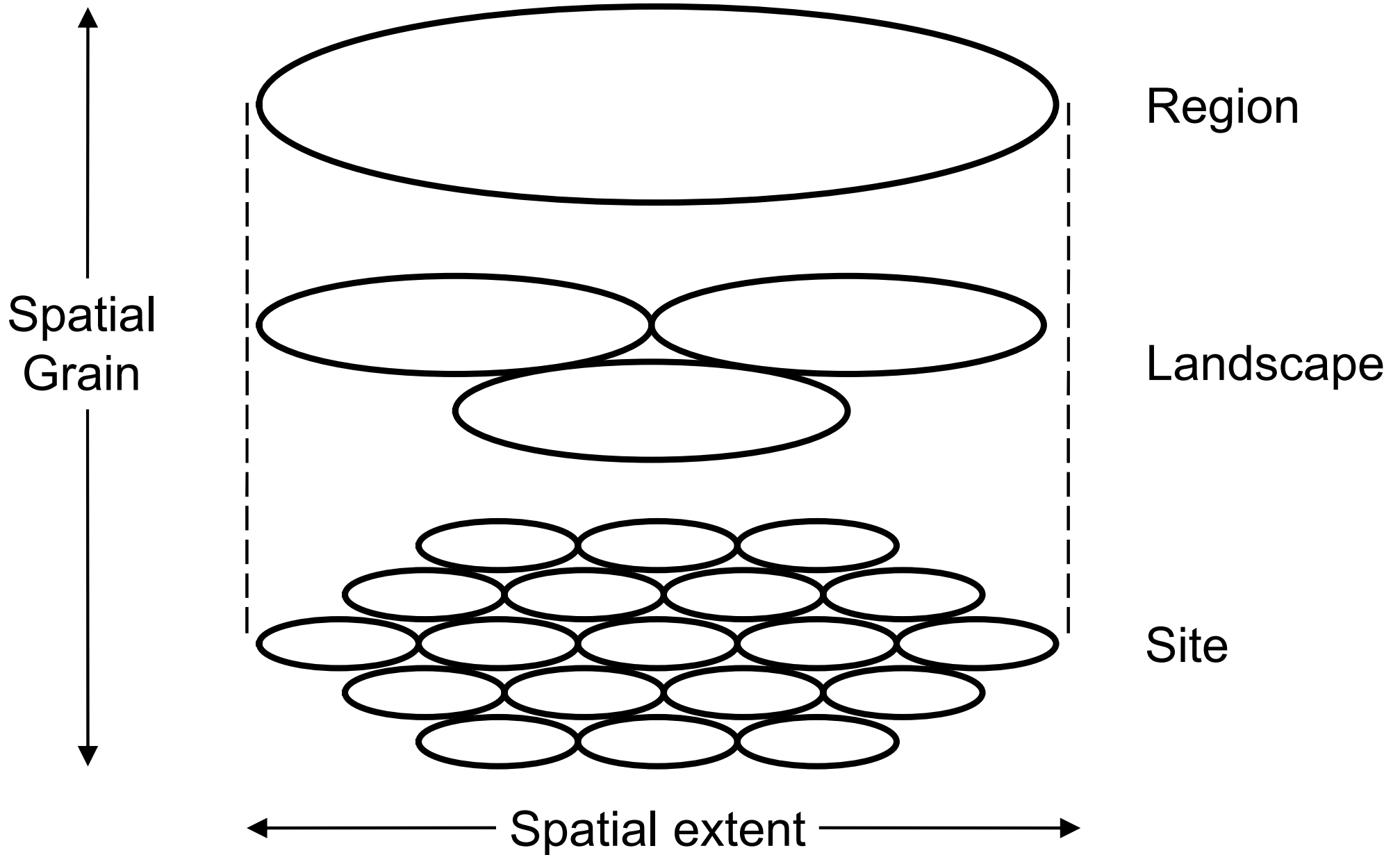

Benefits of context-sensitive, sustainable site planning & design

Society	<ul style="list-style-type: none">- Pedestrian/bicyclist safety- Opportunities for active living- Sense of community- Attractive surroundings- Safe neighbourhoods- Proximity to public services- Minimise negative impacts on surrounding properties- Protect cultural & historic resources
Economy	<ul style="list-style-type: none">- Attract investment- Attract visitors & tourists- Add property value- Create marketable “experiences”- Quicker real estate sales & rentals in tight markets- Attract high-skilled employees & employers- Less time spent commuting- Use land efficiently
Environment	<ul style="list-style-type: none">- Conserve energy- Protect biodiversity- Reduce air & water pollution, and urban heat islands- Protect natural processes & sensitive natural areas

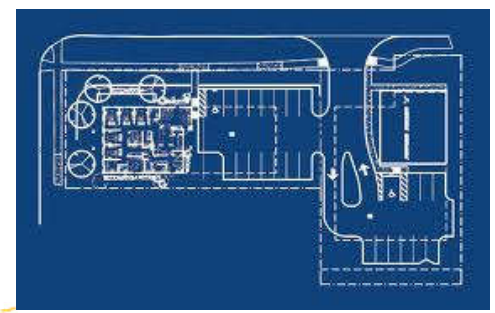

Site planning

- Smart growth (a term used in North America)
 - It is an urban planning and transportation theory that concentrates growth in compact walkable urban centers to avoid “sprawl”
 - It also advocates compact, transit-oriented, walkable, bicycle-friendly land use, including neighborhood schools, complete streets, and mixed-use development with a range of housing choices
 - In UK, known as ‘compact city’ or urban intensification

Comparison of Smart Growth and Sprawl

	Smart Growth	Sprawl
Emphasis	Accessibility: to goods, services, and activities	Mobility: physical movement, particularly by car
Density	Higher density, clustered activities	Lower density, dispersed activities
Growth pattern	Infill development	Urban periphery (greenfield) development
Land use mix	Mixed	Single use, segregated
Public services	Local, distributed, smaller, walking access	Regional, consolidated, larger, requiring car access
Transport	Multimodal transportation and land-use patterns that support walking, cycling, and public transportation	Car-oriented, poorly suited to walking, cycling, and public transportation
Connectivity	Highly connected roads, pavements, and paths allowing more direct travel by motorized & nonmotorized transport modes	Hierarchical road network with many unconnected roads and walkways, and barriers to nonmotorized transport
Street design	To accommodate a range of activities, with street calming	Designed to maximize vehicle throughput
Planning process	Planned and coordinated between jurisdictions and stakeholders	Either unplanned/little coordination, or planned (e.g., USA)
Public space	Emphasis on streetscape, pedestrian areas, public parks, and public facilities	Emphasis on the private realm: of shopping malls, gated communities, private clubs

(Source: ADB. 2007. Environment and Transport Background Paper, *Managing Asian Cities Study*. Manila.)

Site planning

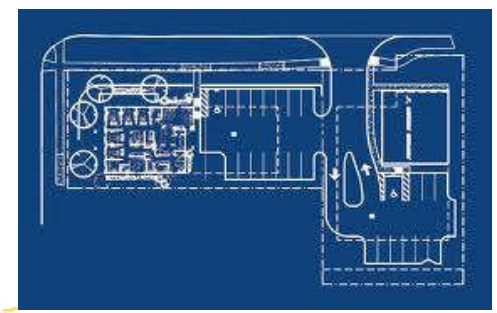

- Smart growth: 10 basic principles
 - 1. Mix land uses
 - 2. Take advantage of compact building design
 - 3. Create a range of housing opportunities & choices
 - 4. Create walkable neighborhoods
 - 5. Foster distinctive, attractive communities with a strong sense of place

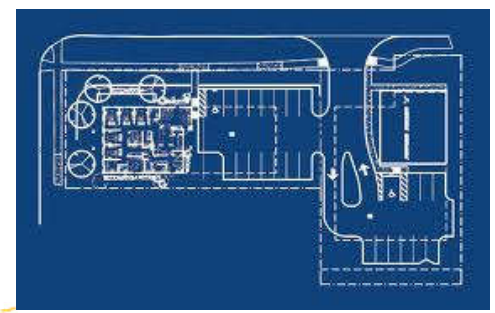

Site planning

- Smart growth: 10 basic principles (cont'd)
 - 6. Preserve open space, farmland, natural beauty, and critical environmental areas
 - 7. Strengthen and direct development towards existing communities
 - 8. Provide a variety of transportation choices
 - 9. Make development decisions predictable, fair, and cost effective
 - 10. Encourage community and stakeholder collaboration in development decisions

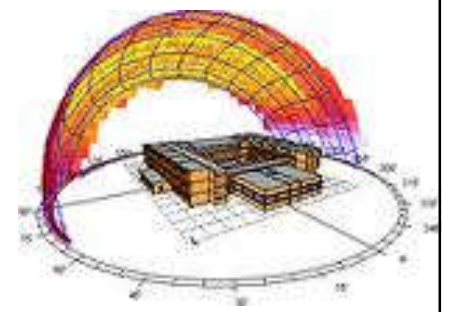

Site selection and analysis

- Site selection
 - Identify & evaluate alternative sites and select the best locations for the intended program, e.g.
 - Urban infill:
 - Development that occurs on vacant or remnant lands passed over by previous development
 - Urban redevelopment:
 - Replacement, remodelling, or reuse of existing structures to accommodate new development

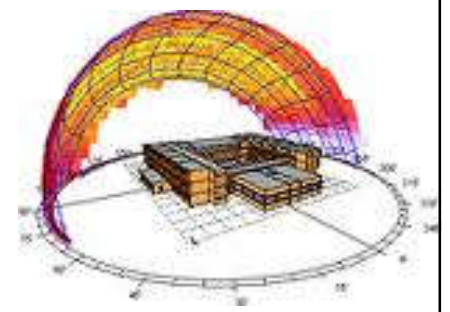

Site selection and analysis

- Site selection: good design practices
 - Select the potential site with regard to sustainable land use issues
 - Compare the potential sites pre-selected
 - Urban infrastructure & facilities
 - Resources & energy potential
 - Water issues
 - Air, water, soil & noise pollution
 - Ecosystems & biodiversity
 - Waste

Client initiates project

The site selection process

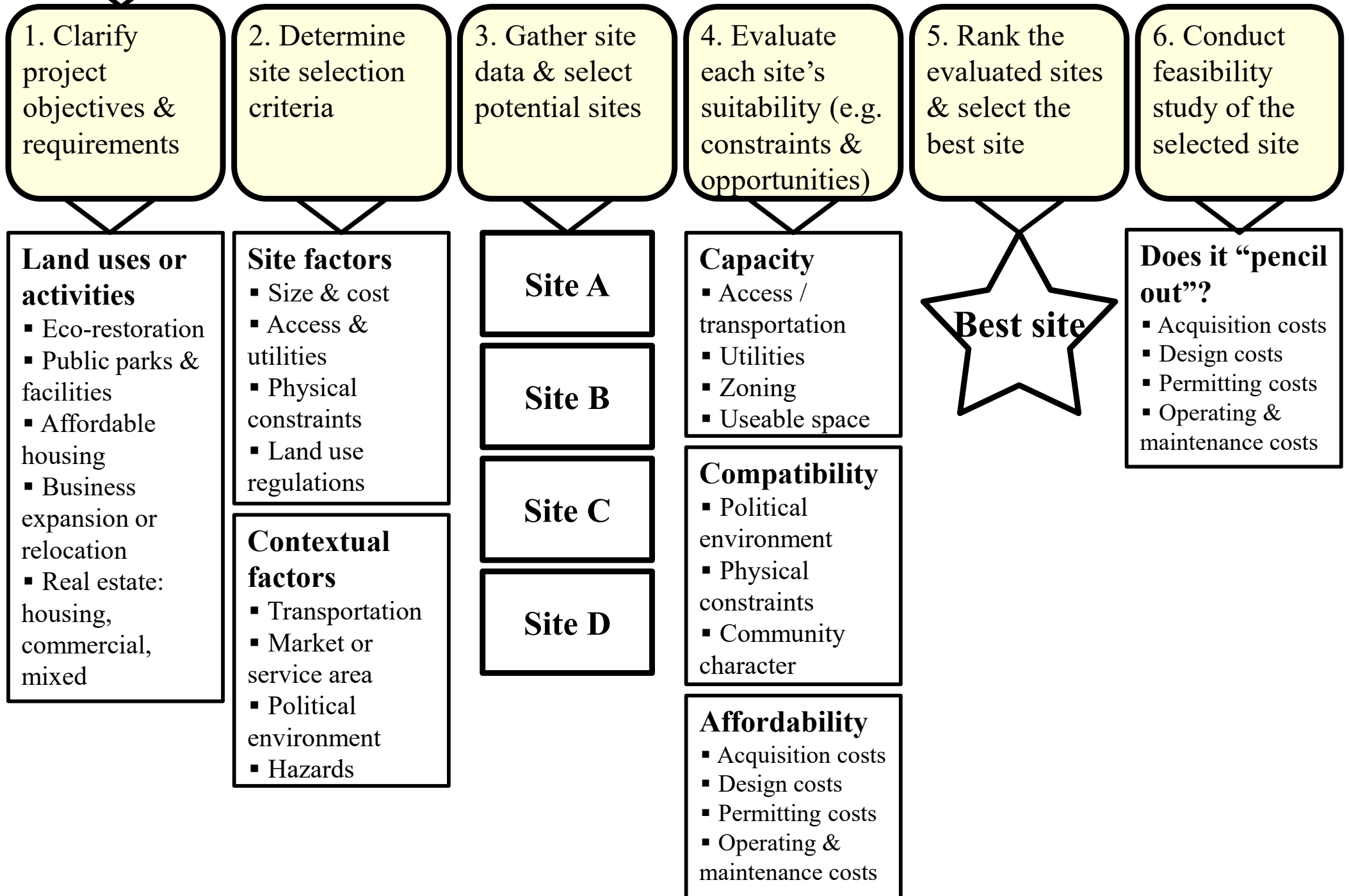

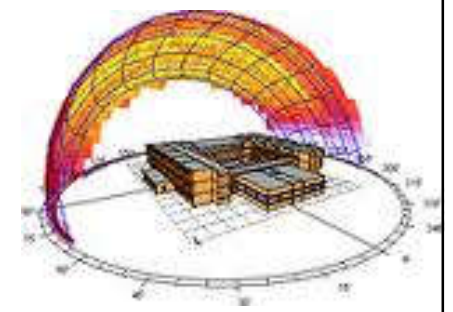

Site selection and analysis

- Site analysis
 - Summarizes the site's suitability for the programmed uses
 - Assesses the site's assets and liabilities (or opportunities and constraints)
 - Intended program:
 - Goals & objectives, land uses & activities, phasing
 - Existing conditions:
 - Physical, biological & cultural attributes

The site inventory produces mapped data on the existing conditions of the site and its context

Site Inventory

Physical Attributes

- Topography (elevation, slope, aspect)
- Hydrology (drainage patterns, wetlands, aquifer recharge areas)
- Soils (stability, erodibility, bearing capacity)
- Geology (landforms, seismic hazards, depth to bedrock)
- Microclimate (solar access, winds, fog, precipitation, frost)

Biological Attributes

- Ecological communities (green infrastructure, habitats, patches & corridors)
- Vegetation (specimen trees, exotic invasive species, endangered or threatened species)
- Wildlife (exotic invasive species habitat, endangered or threatened species)

Cultural Attributes

- Land use (districts, sites, buildings)
- Open space (parks, greenways)
- Regulations (easements, zoning, design guidelines)
- Property (ownership, value)
- Sensory perception (visibility, visual quality, noise, odors)
- Infrastructure (transportation, utilities)

Existing Site & Contextual Conditions

Sustainable landscaping



- Definition:
 - A **sustainable landscape** is designed to be both attractive and in balance with the local climate and environment and requires minimal resource inputs, e.g. fertilizer, pesticides, gasoline, time, and water
 - The design must be functional, cost-efficient, visually pleasing, environmentally friendly and maintainable
 - Preserve limited and costly resources, reduce waste and prevent air, water and soil pollution

Sustainable landscaping



- Components of **sustainable landscaping**:
 - Compost, fertilization, grass cycling, pest control measures that avoid or minimize the use of chemicals
 - Integrated pest management
 - Using the right plant in the right place
 - Appropriate use of turf
 - Irrigation efficiency
 - Xeriscaping or water-wise gardening



10 principles of sustainable landscape construction

1. Keep sites healthy
2. Heal injured sites
3. Favour living, flexible materials
4. Respect the waters of life
5. Pave less
6. Consider the origin and fate of materials
7. Know the costs of energy over time
8. Celebrate light, respect darkness
9. Quietly defend silence
10. Maintain to sustain

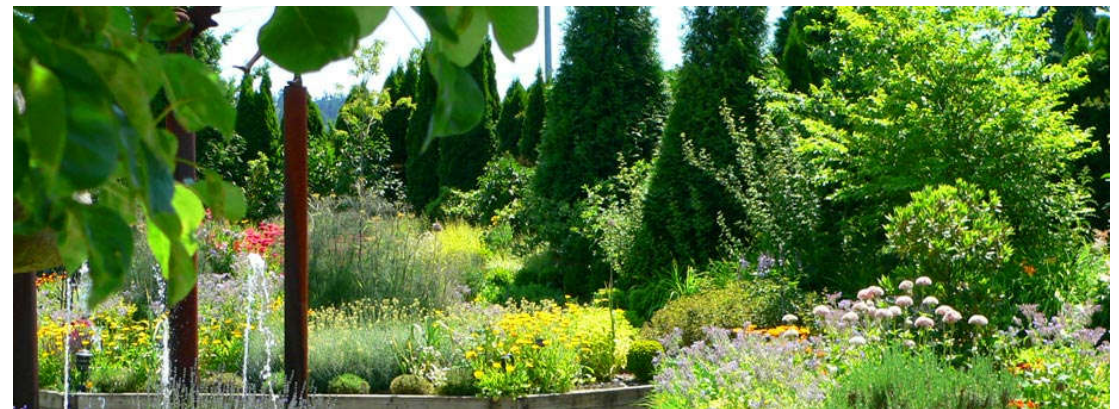

(Source: Salat, S. (ed.), 2006. *The Sustainable Design Handbook: China: High Environmental Quality Cities and Buildings*, CSTB, Cedex, France)

Sample landscape master plan

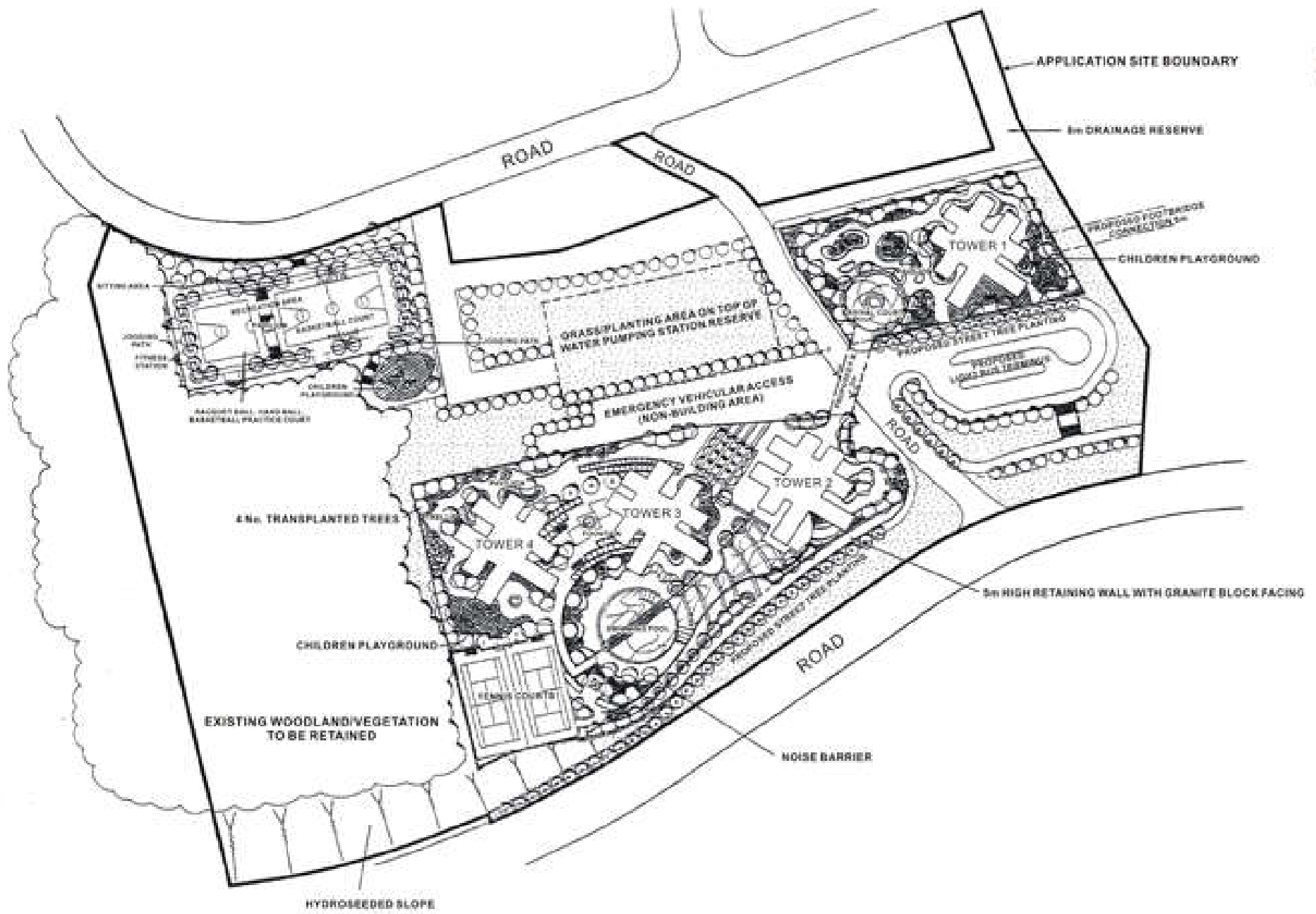

Source : Town Planning Board Guidelines for Submission of Master Layout Plan under Section 4A(2) of the Town Planning Ordinance (TPB PG-No.18A)

(Source: Hong Kong Planning Standards & Guidelines, www.pland.gov.hk/pland_en/tech_doc/hkpsg/)

Sustainable landscaping



- Design of traditional Chinese gardens
 - Integrate ecology & nature within the built environment
 - “The Craft of Gardens” (園冶) by Ji Cheng (計成) published in 1634

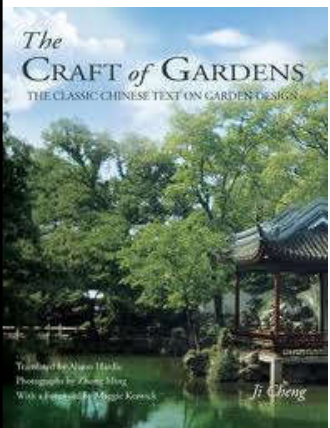

- A respect of nature and the environment; integration into the site
- Protect natural springs & preserve water tables
- Retention of existing plants
- Buildings are harmoniously oriented with the planned activities or envisaged landscape

Sustainable landscaping



- Environmental management of the **water cycle**
 - Aims: reduce water consumption, avoid potential pollution & flood risks
- Recommended planning strategies:
 - Retention: control & manage stormwater drainage
 - Infiltration: percolation of rainwater into the soil to maintain the water cycle
 - Treatment: recuperate runoff water from risk surfaces (car parks, circulation areas, etc.) & treat it prior to discharge



Sustainable landscaping

- Manage the **water cycle**: good practices
 - Water management & landscaping
 - e.g. residential housing with water scene
 - Respect groundwater tables & storm drainage
 - e.g. minimise the extent of impervious surfaces
 - Rainwater recuperation (and reuse)
 - Rainwater management using valleys, percolation wells, roadways & roofs
 - Planted (green) roofs

Sustainable landscaping



- Video: Leveraging the Landscape to Manage Water (4:03)

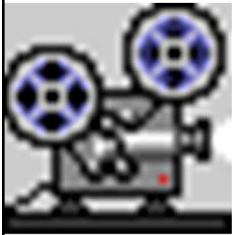

- http://www.asla.org/sustainablelandscapes/Vid_Watermanagement.html
- Enhance stormwater management
- Green roofs, bioswales, bioretention ponds, and permeable pavements are a few key examples of local green infrastructure, and all work by turning hard asphalt surfaces into green, absorbent ones

Green roof research with integrated systems 綠色屋頂的綜合系統研究

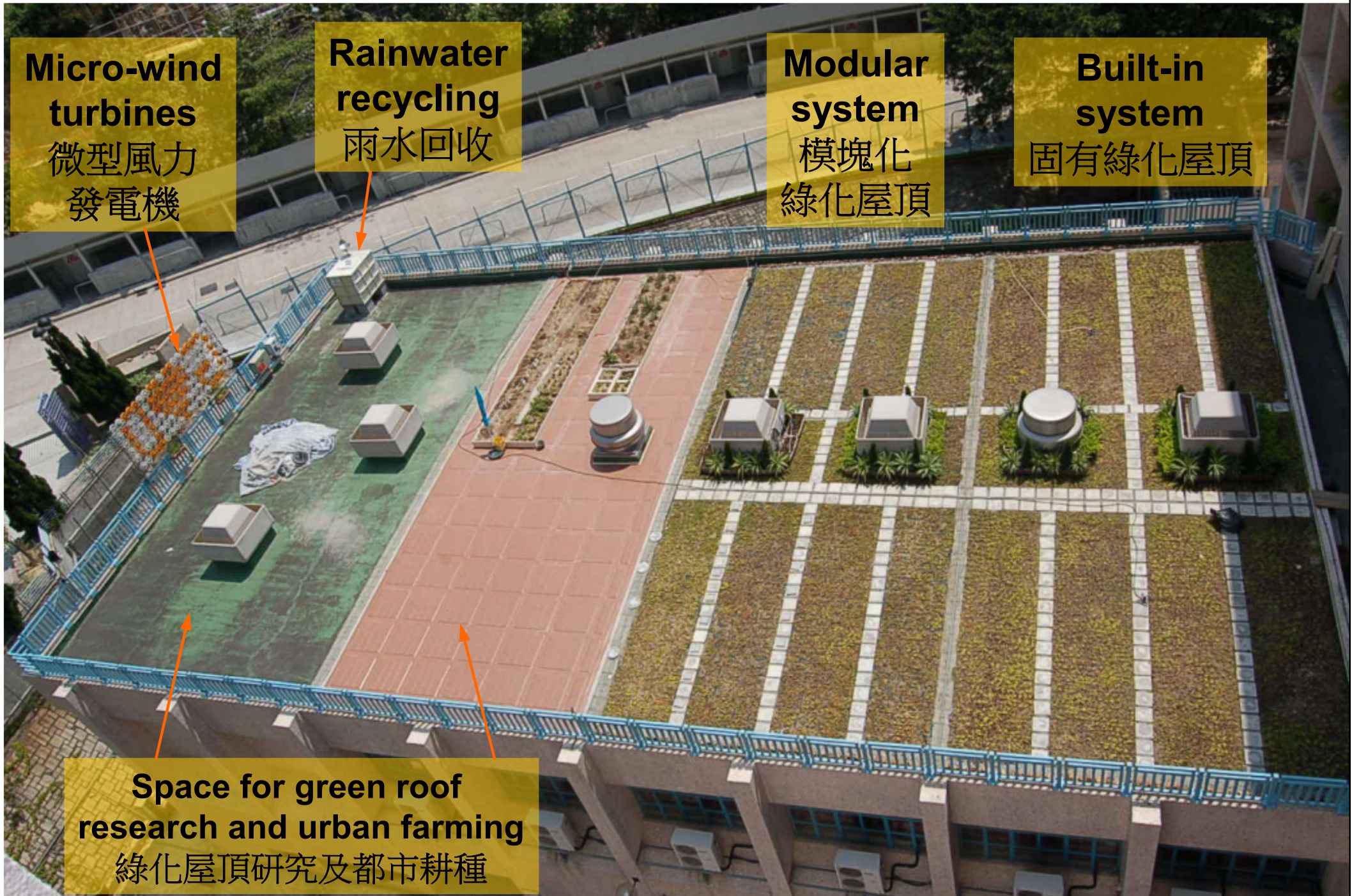

(Further information: <http://ibse.hk/greenroof/>)

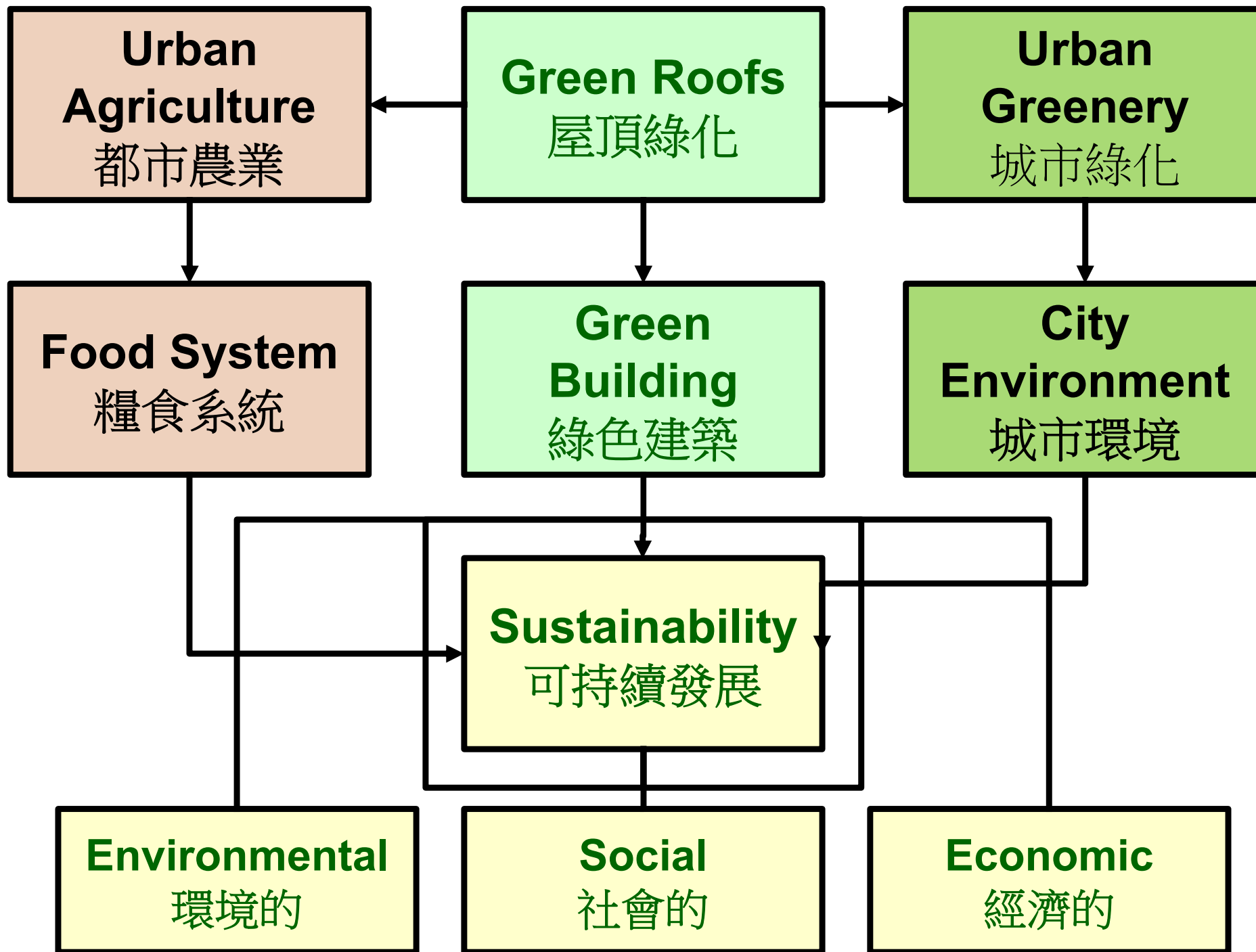

Sustainable landscaping



- Video: The Edible City (3:34)
 - https://www.asla.org/sustainablelandscapes/Vid_UrbanAg.html
 - Urban agriculture, urban farming
 - People grew vegetables, fruits, or herbs
 - Education: teaching kids where food comes from
 - Commercial urban farmers, produce grown in neighborhoods
 - Create a more healthy food system

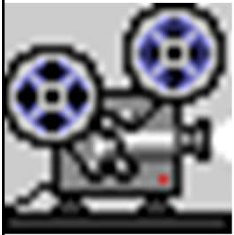

Sustainable transportation



- **Sustainable transport (or green transport)**
 - Any means of transport with low impact on the environment, including walking & cycling, transit oriented development, green vehicles, car sharing, and building or protecting urban transport systems that are fuel-efficient, space-saving & promote healthy lifestyles
- **Sustainable urban mobility (SUM)**
 - Tackle transport-related problems in urban areas,
 - e.g. SUM plans in Europe
https://ec.europa.eu/transport/themes/urban/urban-mobility/urban-mobility-actions/sustainable-urban_en

Sustainable transportation



- Sustainable transport strategy, e.g.
 - Masterplanning checklist (UK)
 - <http://www.transportforqualityoflife.com/policyresearch/planningforsustainabletransport/>
 - Location of new developments
 - Density of development
 - Local facilities & jobs
 - Street layout & design
 - Public transport
 - Parking
 - Restraint on car movement
 - Smart travel behaviour change programmes



Sustainable transportation



- Video: Designing for Active Living (3:53)
 - http://www.asla.org/sustainablelandscapes/Vid_ActiveLiving.html
- Design communities for all users, not just those driving in cars
- Provide multiple transportation options and easier access to outdoor activities
 - Create safe access to transit; “Complete Streets,” which offer wider sidewalks and bike lanes; bike share networks and stations; community trail networks; parks with exercise equipment; and community gardens

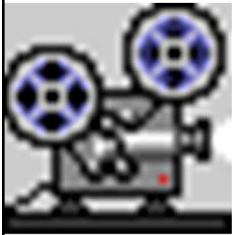

Sustainable transportation



- **Transit-oriented development (TOD)**

- A mixed-use residential or commercial area designed to maximize access to public transport, and often incorporates features to encourage transit ridership

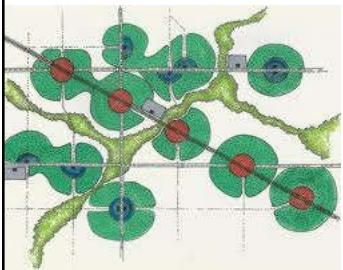

- Examples: new towns in Denmark, France, Japan, the Netherlands; cities e.g. San Francisco, Toronto, Vancouver, Edmonton
- In Hong Kong, e.g. LOHAS Park, Olympian City, Tung Chung

大眾運輸導向型發展

Sustainable transportation



- **Transit-oriented development (TOD) (cont'd)**
 - A TOD neighbourhood typically has a centre with a transit station or stop (train or subway station, tram or bus stop), surrounded by relatively high-density development with progressively lower-density development spreading outward from the center. TODs generally are located within a radius of one-quarter to one-half mile (400 to 800 m) from a transit stop, as this is considered to be an appropriate scale for pedestrians

7 principles for transit-oriented development

1. Quality Public Transit
2. Active Transport
3. Car Use Management
4. Mixed-Use Neighborhoods with Efficient Buildings
5. Neighborhood Centers and Vibrant Ground Floors
6. Public Spaces
7. Community Participation and Collective Identity

Benefits of TOD projects

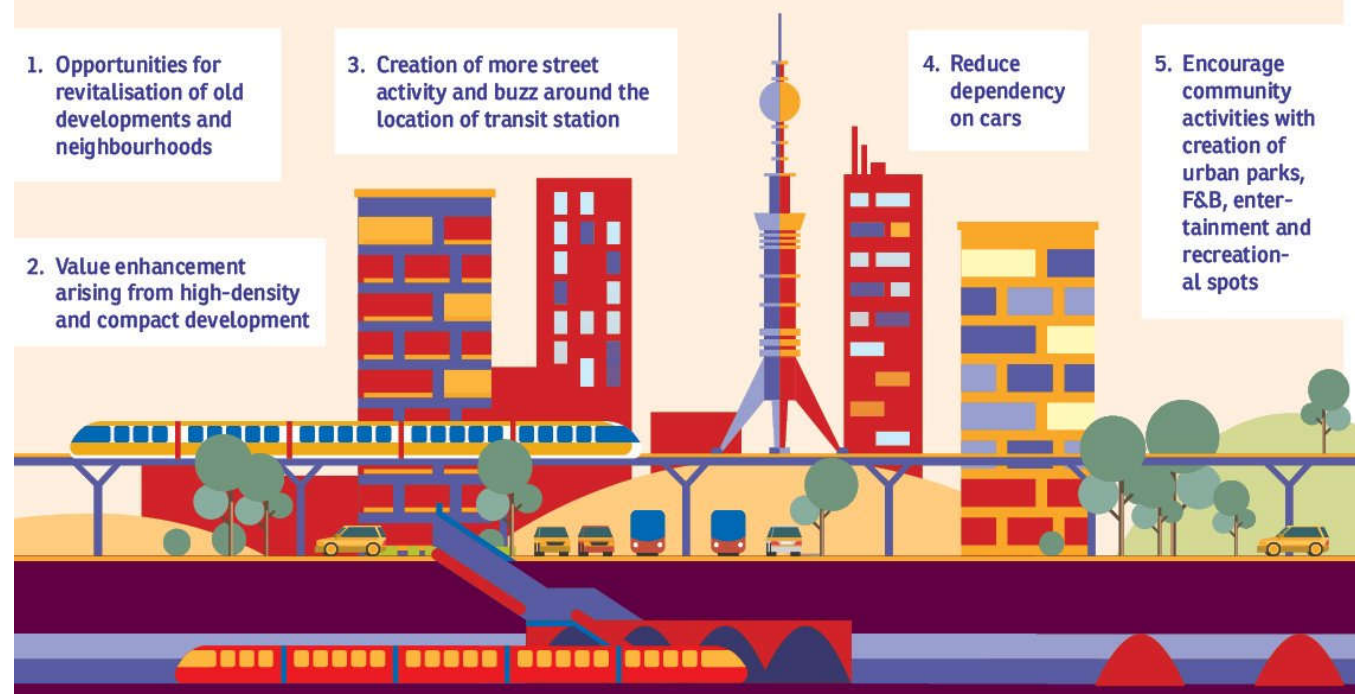

TOD the right mix matters! Building blocks for inclusive cities

THE RIGHT MIX FOR A NEIGHBORHOOD INCLUDES:

MIX OF ACTIVITIES

HOUSING, JOBS, SCHOOLS AND RETAIL
COMPLEMENTARY USES

so that your neighborhood is vibrant from morning till evening and supports good transit over long hours.

EVERYDAY NECESSITIES
ACCESS TO LOCAL SERVICES

so that you can easily walk to at least an elementary school, health services, and a fresh food market to help meet your daily needs.

GREEN AND OPEN SPACES
ACCESS TO PARKS AND PLAYGROUNDS

so that you can go out play, interact, and maintain your physical and mental health close by.



MIX OF PEOPLE

HOUSING OPPORTUNITIES FOR ALL
INCOME LEVELS
AFFORDABLE HOUSING

so that your neighborhood is diverse and offers housing options for all.

LONG-TERM AS WELL AS NEW RESIDENTS
HOUSING PRESERVATION

so that your neighborhood can grow without uprooting the people who already live there.

OLD LOCAL BUSINESSES AS WELL
AS NEW ONES
BUSINESSES AND SERVICES PRESERVATION

so that old businesses continue serving and employing local people while new ones enrich local activity.

Sustainable transportation



- Examples in other countries:
 - Greening Paris - Sustainable Transport Award (7:01) <http://youtu.be/QmW-jKhRJI>
 - Tramways (w/ greening), the Velib Cycles, road design
 - Transit Oriented Development (City of Edmonton, Canada) (3:43) <http://youtu.be/XYw8XXIMuLM>
 - Concentrates housing, shopping and employment along a network of walkable and bikeable streets within a five-minute walk in any direction of a transit station
 - https://www.edmonton.ca/city_government/urban_planning_and_design/tod-guidelines.aspx

Sustainable transportation



- Transport strategy in Hong Kong
 - Objectives:
 - Better integration of transport and land use planning
 - Better use of railways
 - Better public transport services and facilities
 - Better use of technology in traffic management
 - Better environmental protection measures in relation to transport infrastructure and activities
 - Rail systems (mass transit railway (MTR), light rail, tramways), buses, taxi, ferry

Sustainable transportation



- Urban development approach in Hong Kong
 - Public transport-oriented development, or rail-based transit-oriented development (TOD)
 - About 42% of the households, 43% of the employment population and 75% of the commercial and office floor areas are located within a radius of 500 metres of railway stations
 - Integration of land use and transport planning
 - A compact and highly efficient urban development
 - The efficiency of service industries would depend on the mobility of people

Development clusters around the railways stations in Hong Kong

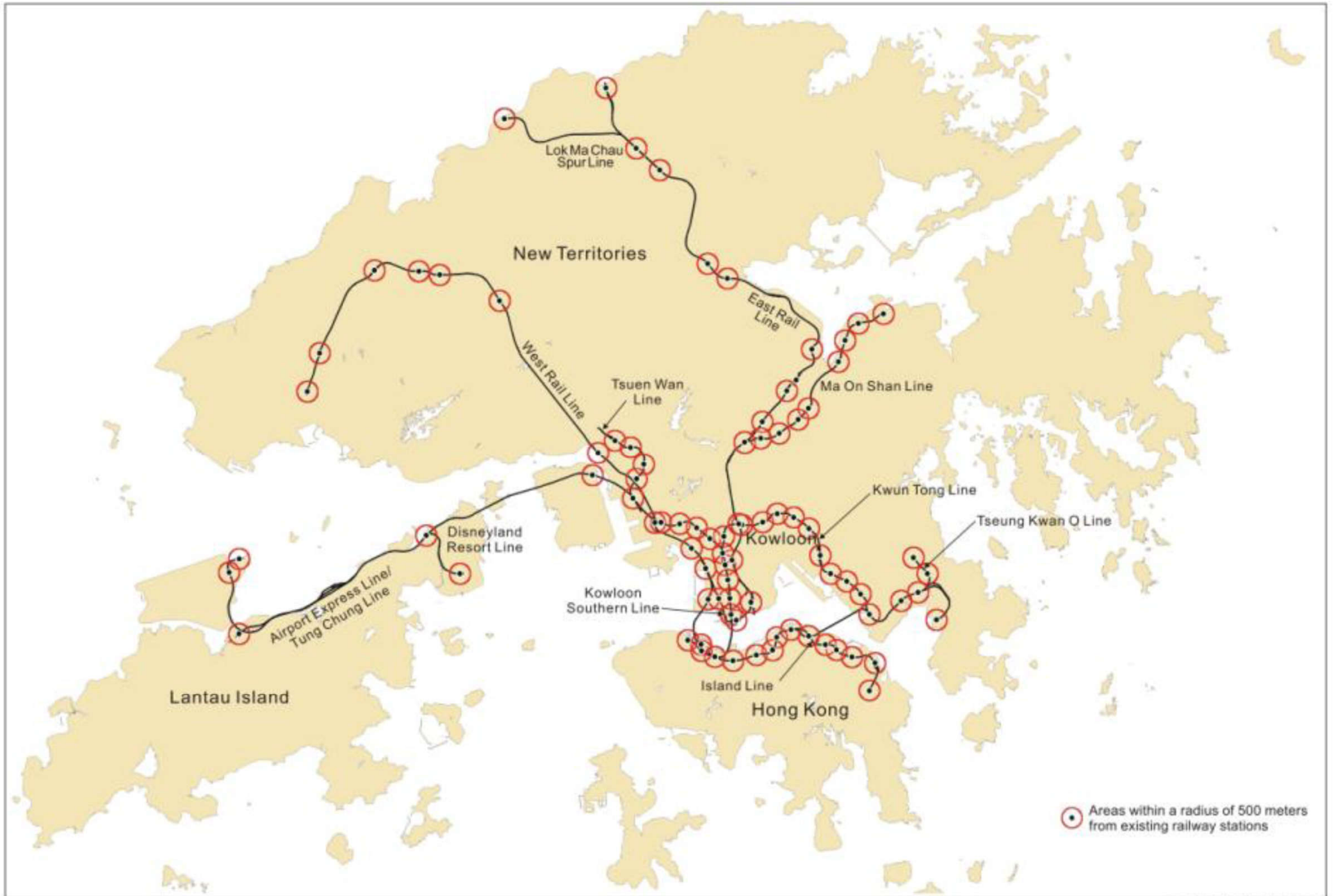

港鐵路綫圖

MTR system map 2030



(Source: www.mtr.com.hk)

Example of a typical section of a podium decking design of developments over a major public/rail transport interchange

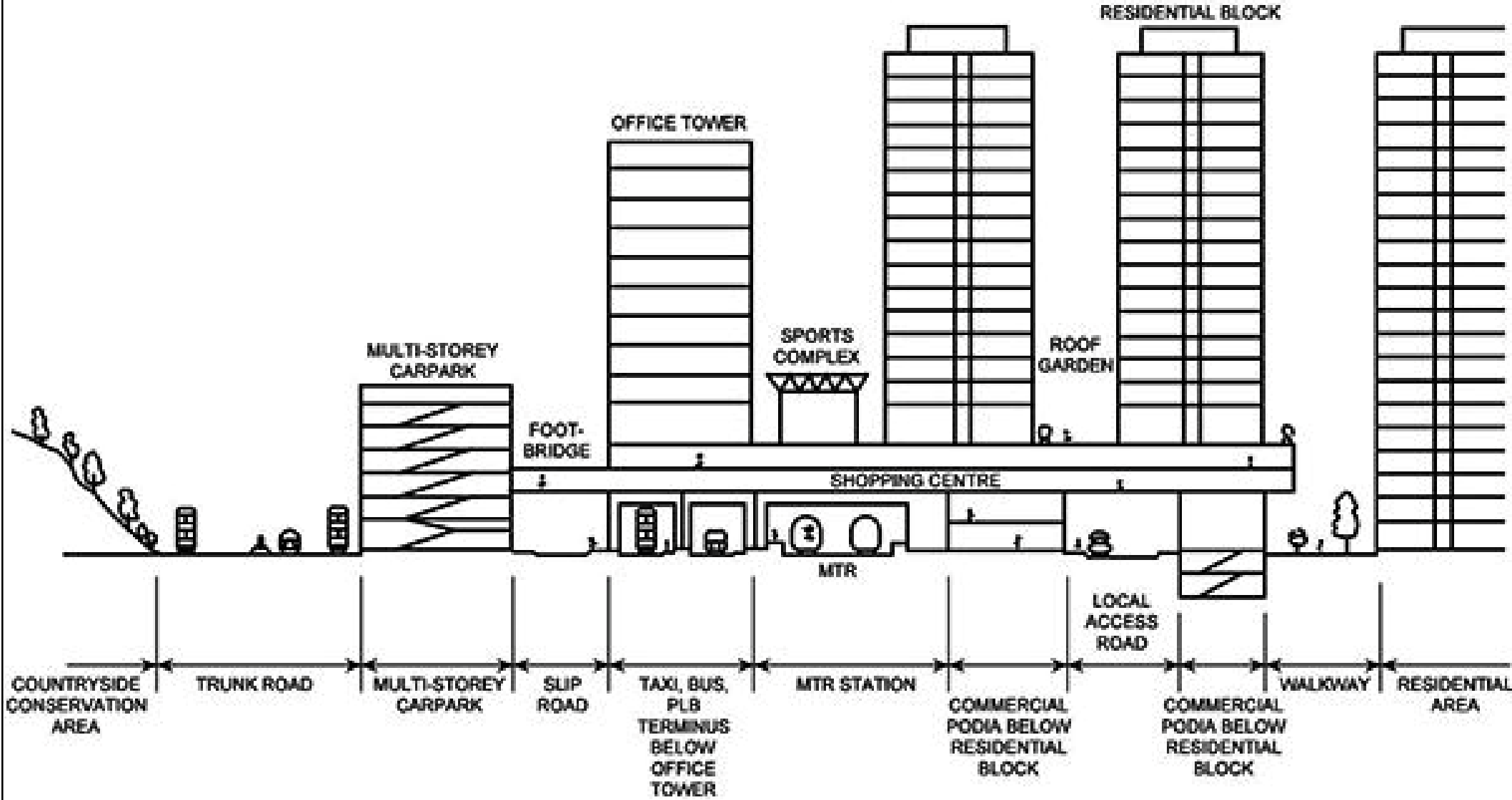

(Source: Hong Kong Planning Standards & Guidelines http://www.pland.gov.hk/pland_en/tech_doc/hkpsg/)

An example of transit-oriented development (TOD) in Hong Kong: Olympia City (奧海城), West Kowloon



Suggested field study: You may walk around this area to evaluate.

Further Reading

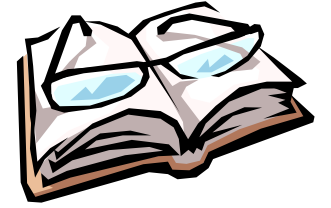

- Liveability: a People-centric Approach under Hong Kong 2030+

https://www.hk2030plus.hk/document/KSS_PPT/1st_KSS/Liveability-A_People-centric_Approach.pdf

- Designing Our Future: Sustainable Landscapes (ASLA) <http://www.asla.org/sustainablelandscapes/>

- 7 Principles for Transit-Oriented Development

<https://thecityfix.com/blog/7-principles-transit-oriented-development-tod-nossa-cidade-luisa-zottis/>

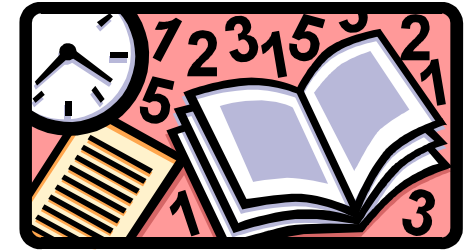

References

- LaGro, J. A., 2008. *Site Analysis: A Contextual Approach to Sustainable Land Planning and Site Design*, 2nd ed., John Wiley & Sons, Hoboken, N.J. [[720.28 L179 s](#)]
- Moughtin C. & Shirley P., 2005. *Urban Design: Green Dimensions*, 2nd ed, Architectural Press, Oxford & Boston. [[720.47 M92](#)]
- Salat, S. (ed.), 2006. *The Sustainable Design Handbook: China: High Environmental Quality Cities and Buildings*, CSTB, Cedex, France. [[720.470951 S96](#)]