

MEBS6006 Environmental Services I

<http://www.hku.hk/bse/MEBS6006>



Condensation and Heat Rejection



Dr. Benjamin P.L. Ho

Department of Mechanical Engineering

The University of Hong Kong

E-mail: benjamin.ho@hku.hk

November 2011

Content



- **Condensation**
 - **Types of Condensers**
- **Advantages and Disadvantages of Evaporative Cooling**
- **Types of Cooling Towers**
- **Considerations when using Cooling Towers**
- **Thermal Analysis of Cooling Towers**
 - **Worked Example**

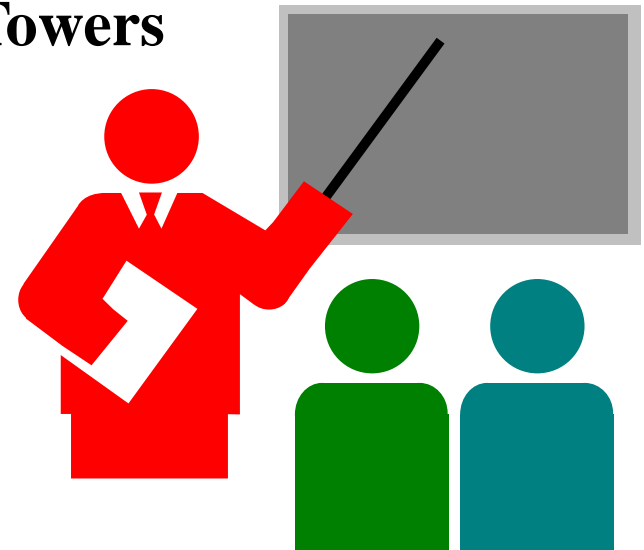

Condensation

- In the refrigeration cycle, heat is rejected at the condenser. Take the vapour compression cycle as an example, the heat transfer process occurs in three stages:
 - De-superheating of the hot gas
 - Condensing the gas to liquid state → release of latent heat
 - Subcooling of the liquid refrigerant
- Heat in the condenser is rejected from the refrigerant to a cooling medium. The two common media are: air and water
- Condensers using these media are classified as:
 - Water-cooled condensers
 - Air-cooled condensers
 - Evaporative condensers

Water-cooled Condensers

- Condenser water circulates in the condenser to remove the heat from the refrigerants. The condenser water can be either
 - Recirculating water from the cooling tower
 - Water from lake or river (inland water)
 - Seawater from seashore

Water-cooled Condensers

- Shell-and-tube: outer shell with tubes inside
- Double-tube: two tubes, one inside the other

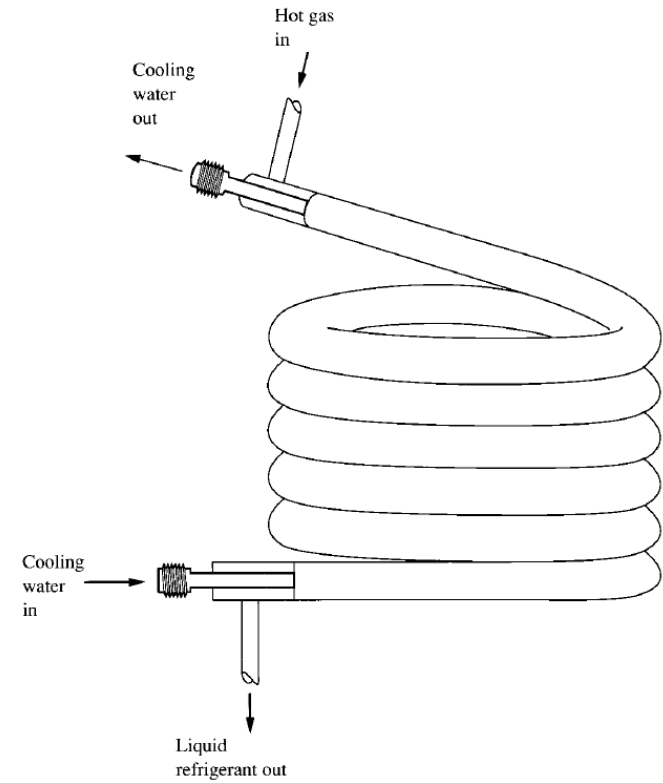
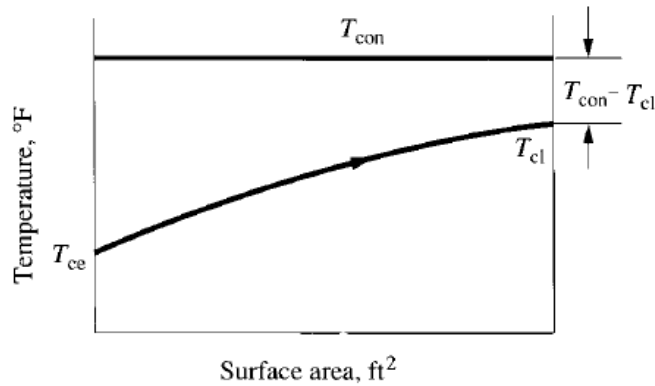
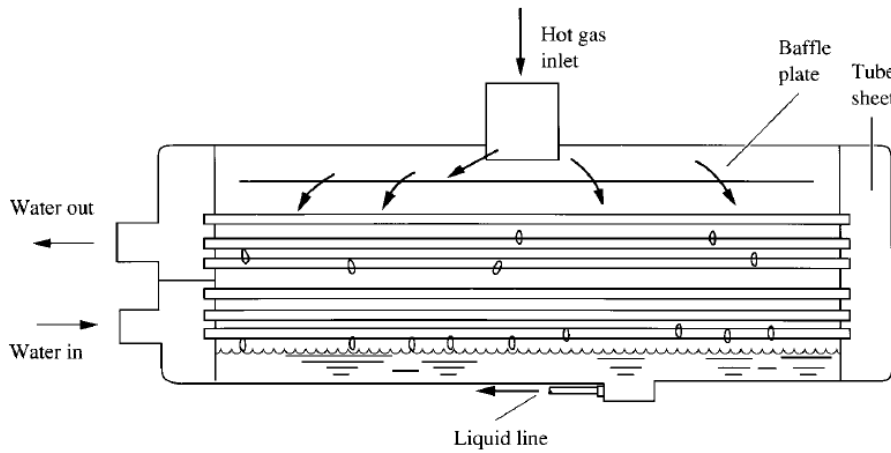

- Heat transfer in Shell-and-tube Condensers
 - T_{con} = condensing temperature of refrigerant
 - $T_{\text{ce}}, T_{\text{cl}}$ = entering and leaving water temperature
 - Commonly, $T_{\text{con}} - T_{\text{cl}} = 3$ to 6 °C
 - Heat transfer coefficient
 - $h_{\text{con}} = f (1/(T_{\text{con}} - T_s))$ where T_s = surface temperature of wall
 - $h_{\text{con}} = C_{\text{con}} [1/(Q_{\text{rej}}/A_o)]^{1/3}$

Air-cooled Condensers

- Condenser coil using copper tubes and aluminium fins (hydrocarbon refrigerant)

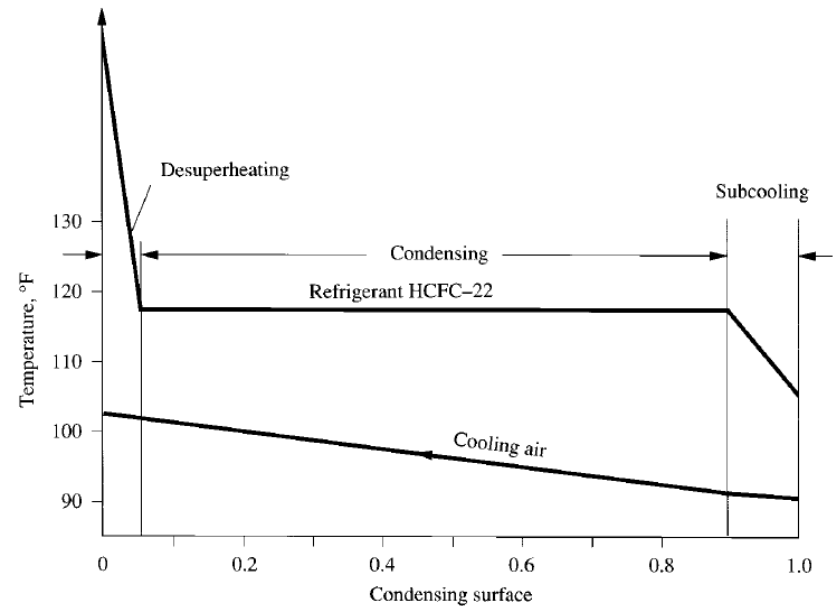
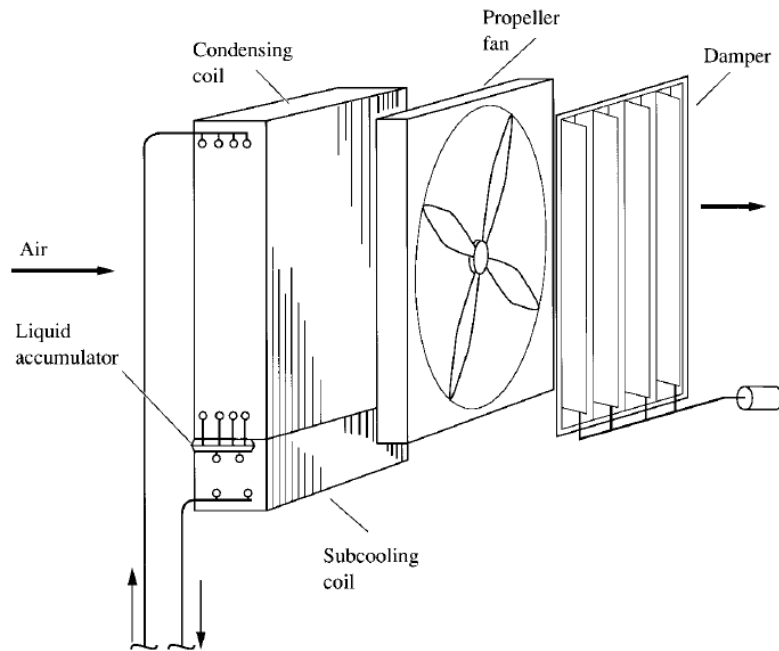

- Temperature rise of air entering and leaving ($T_{al} - T_o$) depends on the volume flowrate per unit heat rejection (V_{ca} / Q_{rej})
- Lower (V_{ca} / Q_{rej}) results in
 - lower heat transfer coefficient h ,
 - \rightarrow greater log mean temperature difference between refrigerant and air,
 - greater ($T_{al} - T_o$) \rightarrow hotter air leaving the condenser
 - \rightarrow higher condensing temperature T_{con} ,
 - lower condenser fan power
- Optimum (V_{ca} / Q_{rej}) = 80 - 161 L/s per kW

Evaporative Condensers

- Use of water spray to cool the outer surface of the condenser coil

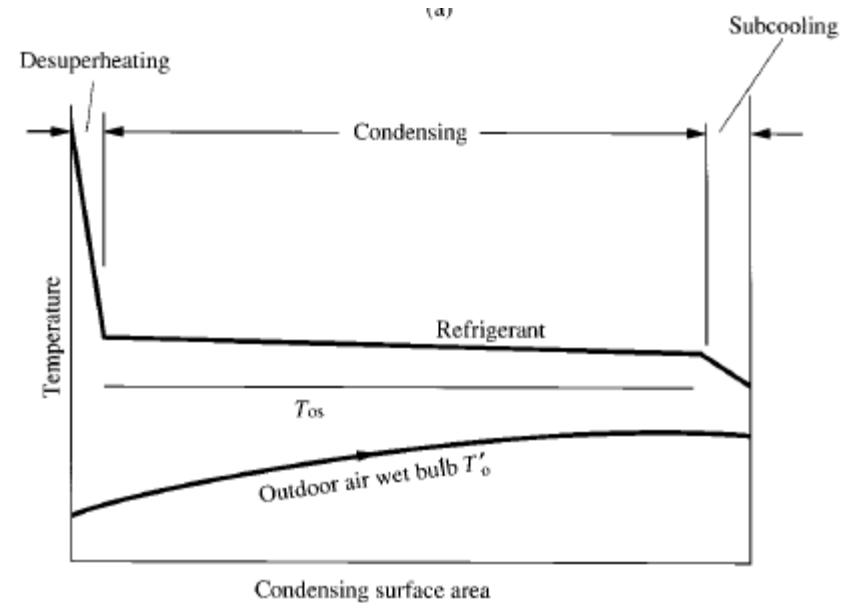
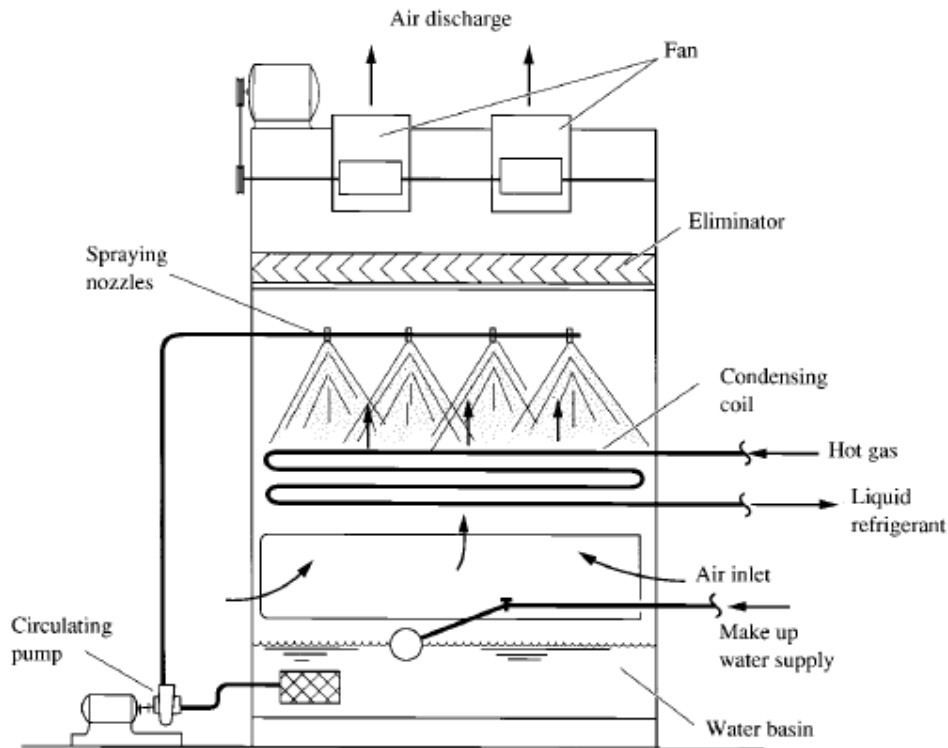

Schematic Diagram for a Typical Water-cooled Air Conditioning System

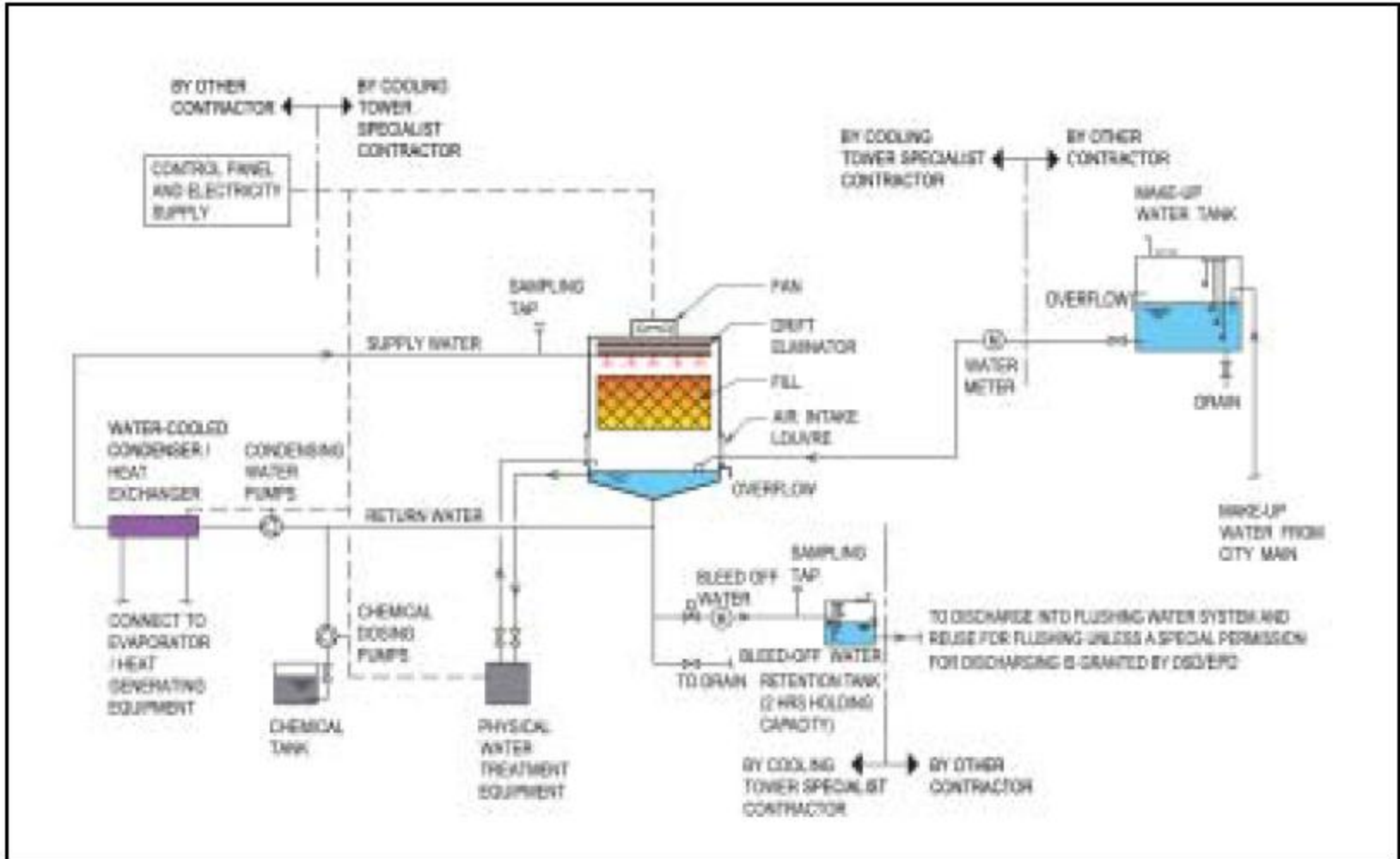
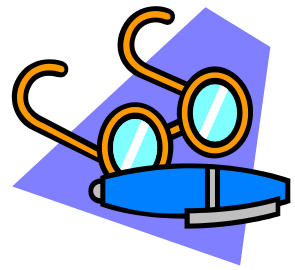

Advantages of using Evaporative Cooling

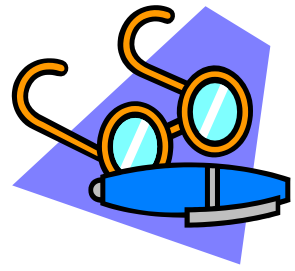

- Electricity consumption

Evaporative cooling is about 10% less than air-cooled method.

- Capital cost

Evaporative water cooling system is about 15% lower than air-cooled system

- Operating life

Air-cooled packaged chiller condensers is around 10 to 15 years

Fresh water cooling towers is around 15 to 20 years.

- Fewer power consumption

Fewer emissions of greenhouse gas and pollutants from power stations

(SO₂ , NO_x, CO₂ and particulate) to help improving air quality.

Disadvantages of using evaporative cooling

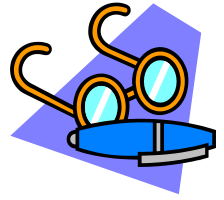

- Bleed-off of cooling tower
Evaporative cooling method → environmental impact from bleed off
- Negative impact on sewage treatment works
Depending on the effluent quality and water treatment method.
- Cost of water consumption and water treatment method
The saving on total cost may not be significant
- Spread of Legionnaires disease.
Precautionary measures needed
- Air intakes of ventilation and air conditioning system
Away from them due to water mist and noise's emission

Types of cooling tower

Counter flow forced draft



- Fan is situated at air intake (i.e. upstream of fill).
- At the bottom of the tower and blow through method is used.
- Discharged air from this type of cooling tower has a smaller velocity

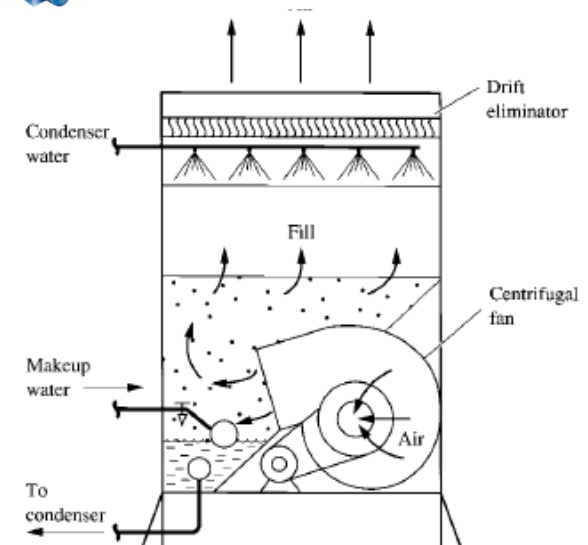

Types of cooling tower

Counter flow **forced** draft

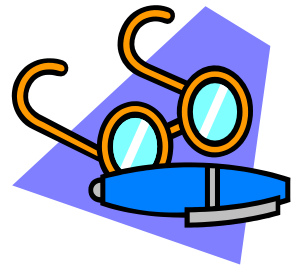

Advantages:

- Fans close to ground → minimum vibration
- More efficient than induced draught - velocity pressure converted to static pressure does useful work, while the fan handles inlet cold air → weight of air per unit greater than induced draught arrangement.
- Fans and motors are situated in a comparatively dry air stream and are more easily accessible for maintenance.

Disadvantages:

- Limited fan size → needed a larger number of smaller fans of higher speed compared with induced draught arrangement → more noise
- Low outlet air velocities → Prone to recirculation of used air into the accessible low pressure fan inlet → reduction in performance → Ducted the air away at high velocity → greater resistance and increased fan power

Types of cooling tower

Counter flow induced draught cooling tower

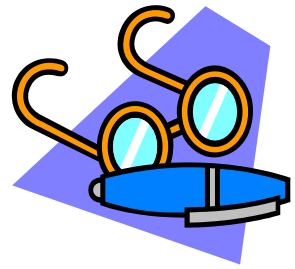

- Fan is located at the air outlet (on the top of cooling tower.)
- Air enters at the bottom and is discharged to the top.
- Water falls downward over the fill and drops to water basin.

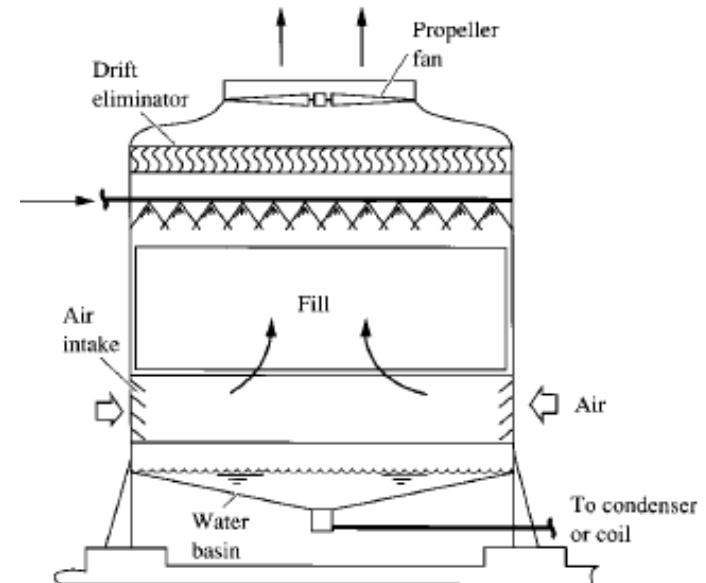

Types of cooling tower

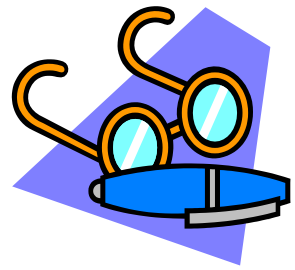

Cross flow induced cross draught cooling tower

- Fan is at the top of the cooling tower.
- Air enters at the side and moves **horizontally** through fill.
- It then move upwards and discharge at the top.
- Water spray falls across the fill and forms a cross flow arrangement with the air stream.
- Allows a greater air intake area
- Tower is lower than the counter flow one.

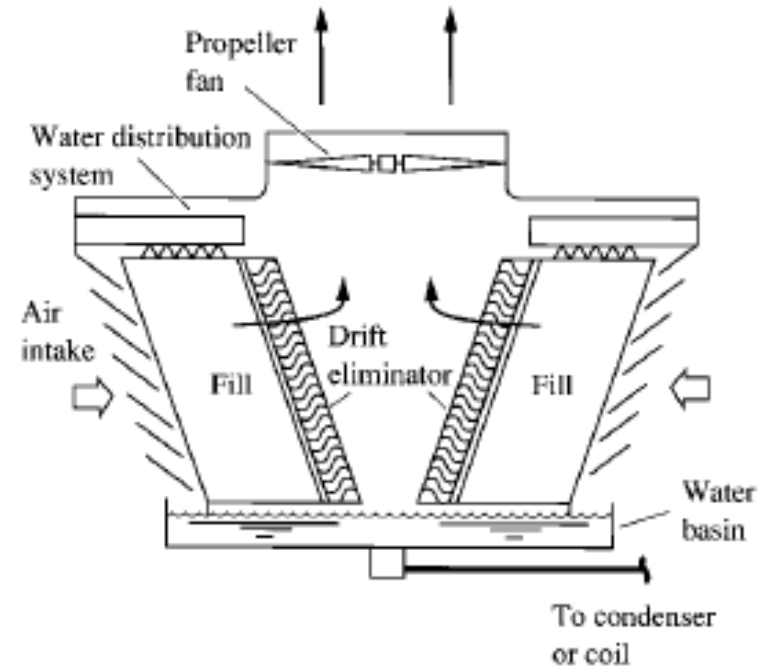
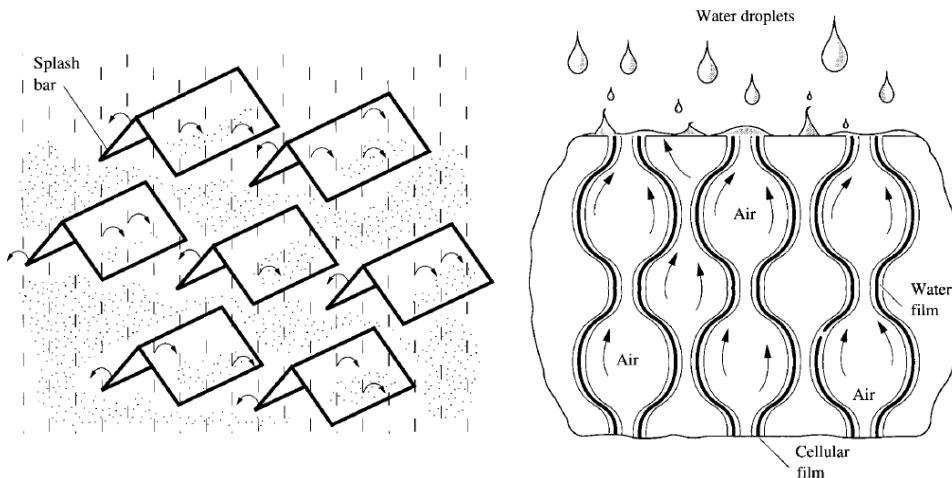

Types of cooling tower

Induced flow draught or cross flow cooling tower

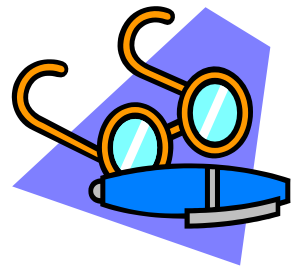

Advantages:

- Large fans possible (hence low speed and low noise).
- Recirculation of air unlikely due to higher outlet velocity.
- More compact plan area than forced draught due to absence of fans on side.

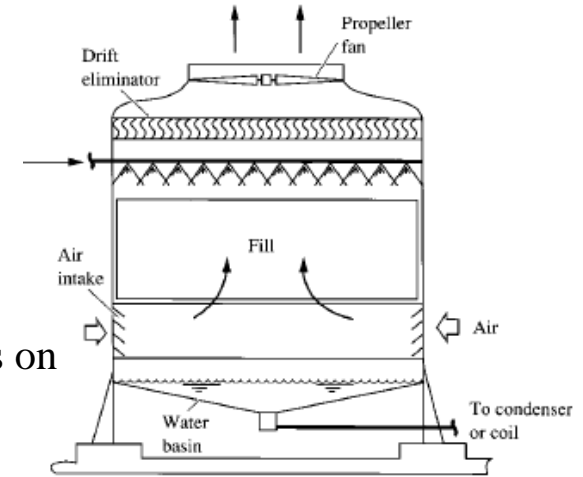

Disadvantages:

- More prone to vibration since fan is mounted on superstructure.
- Mechanical parts less readily accessible for maintenance.
- Mechanical parts located in a hot, humid air stream.
- High inlet velocities can draw in rubbish; air filters can be fitted.

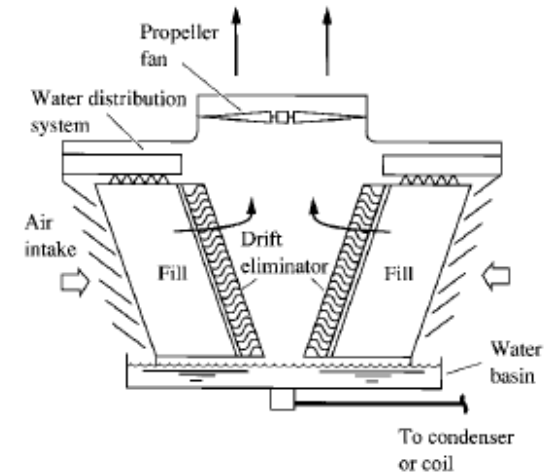

Consideration of using Cooling Towers

Sitting of cooling towers and their discharge

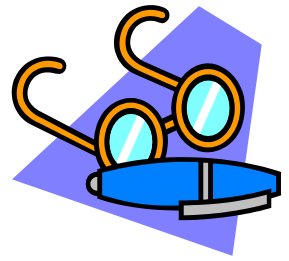

When locating cooling towers, the following factors shall be note :

- (a) the height of adjacent structures;
- (b) direction of prevailing winds;
- (c) location of building air inlets, operable windows and public access areas;
- (d) proximity of other thermal and contaminated discharges.

Consideration of using Cooling Towers

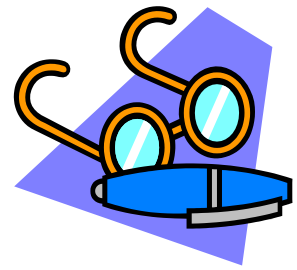

Minimum horizontal separation

Minimum separation requirement for cooling towers installed on building roof

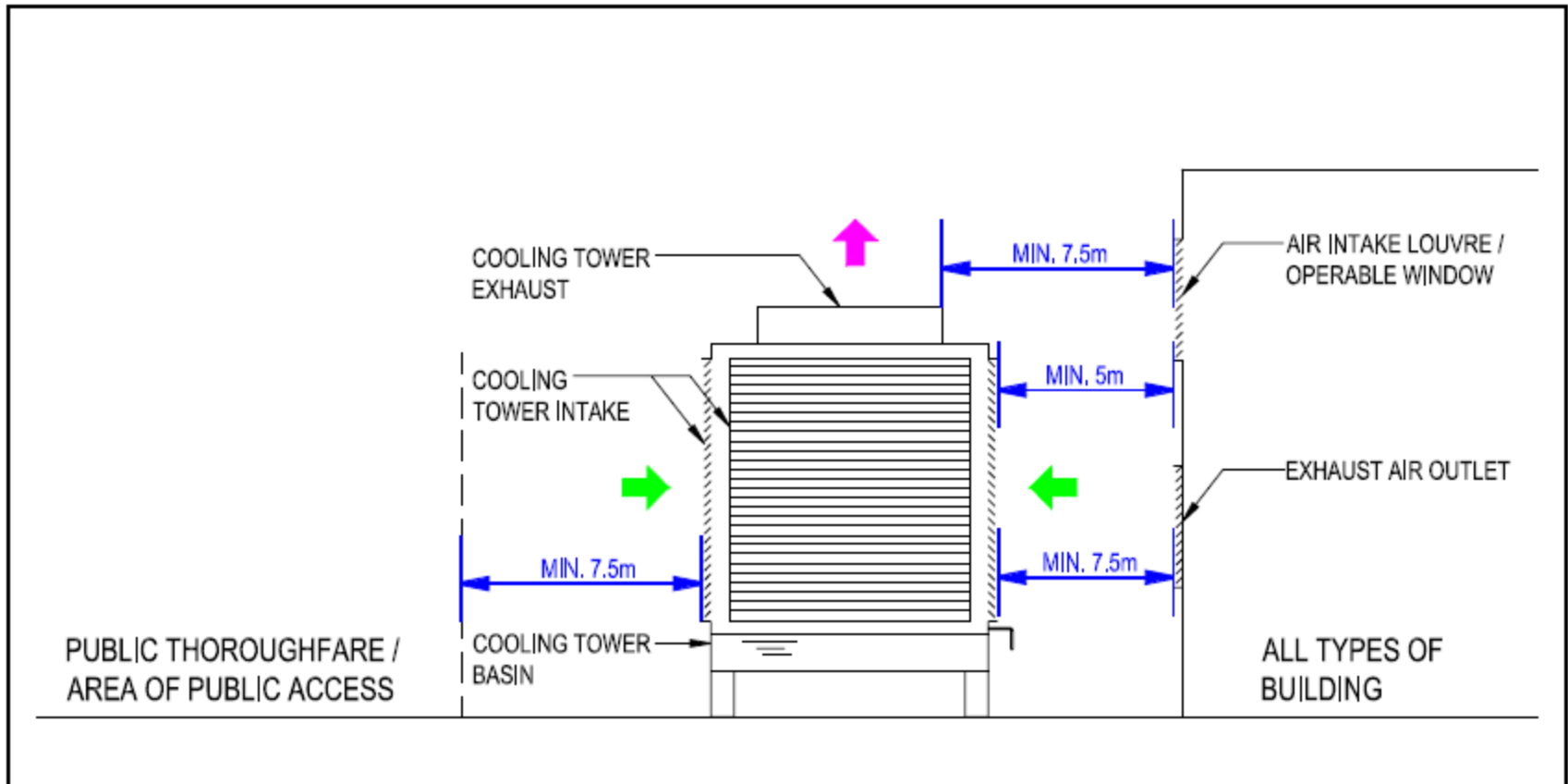

Consideration of using Cooling Towers

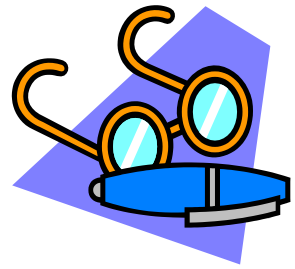

Drift Eliminator

- Drift eliminator removes entrained water from the discharged air
- Allowing air to have sudden changes in direction.
- The resulting centrifugal force separates the water droplets from the air
- The water droplets attach to the eliminator surface and allows them to return to the cooling tower basin.
- Drift emission of the drift eliminator not exceed 0.005% of the maximum design water circulation rate through the cooling tower.
- Drift emission test under design maximum air flow and maximum water flow conditions

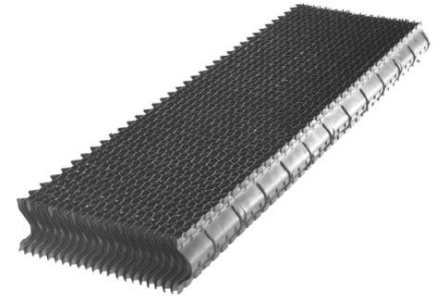

Drift eliminator not extended across whole air stream

Consideration of using Cooling Towers

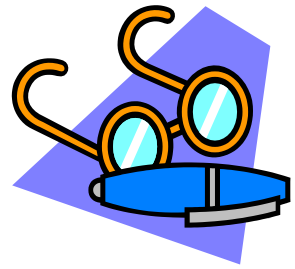

Water treatment

Purpose

- To prevent scale formation and corrosion in the system,
- To control the growth of microbial organisms in cooling water,
- To maximize the system efficiency,
- To save energy,
- To prolong the equipment life,
- To reduce the system downtime and
- To protect the public health.

Method

- Auto-dosing equipment and auto-bleed off device

Consideration of using Cooling Towers

Chemical dosing & Water sampling points

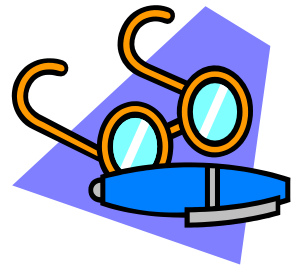

Chemical dosing

- Chemicals added to turbulent zones of the cooling tower system to achieve rapid mixing and well distribution of chemicals.
- Dosing points should be away from the sampling point
- Dosing of chemicals occur immediately after the cooled condenser water leaves the cooling tower.

Water sampling points

- Not near the downstream of chemical dosing point
- Not at the point where the bleed-off is discharged and make-up water is introduced.
- On the return line between the chillers and the cooling tower

Consideration of using Cooling Towers

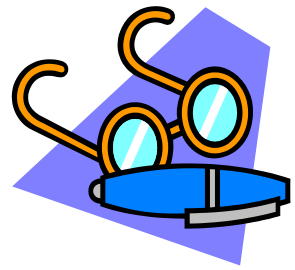

Indicative cooling water quality table for fresh water type cooling tower

Parameters	Cooling Water Quality Criteria
Heterotrophic colony count	Less than 100,000 cfu/mL
Legionella bacteria count	Less than 10 cfu/mL
Conductivity	Less than 1500 μ S/cm
Total dissolved solids	Less than 1500 ppm
Suspended solids	Less than 180 ppm
Calcium hardness	Less than 500 ppm
pH	8 – 10
Total alkalinity	80 – 500 ppm
Oxidising biocide	Follow manufacturers' specifications
Inhibitor level	Follow manufacturers' specifications
Temperature	Optimal temperature for the system design and current operating conditions
Chloride as mg/L Cl	Less than 200 mg/L
Sulphate as mg/L SO ₄	Less than 200 mg/L
Total iron as mg/L Fe	Less than 1.0 mg/L
Residual Cl	Less than 0.3 ppm
BOD ₅ COD Metal ions	Refer to EPD's Technical Memorandum on Standards for Effluent Discharged into Drainage and Sewerage Systems, Inland and Coastal Waters

Consideration of using Cooling Towers

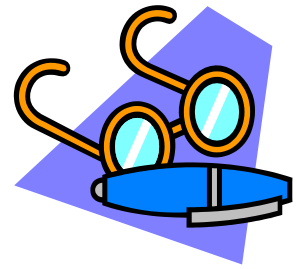

Dead legs and stagnant water

- Dead leg : any pipe that branches off from the main pipe and has a length longer than the diameter of the main pipe.
- It is a favourable place for the growth of bacteria.
- It contains stagnant water and biocides added to the system could not reach to the dead leg to control the bacterial growth.
- It shall either be removed or added with purge valves for regular draining to minimise the risk of stagnant water.



A long dead leg branches off from the main pipe



A long dead leg extends from the main pipe

Consideration of using Cooling Towers

Legionnaires Disease

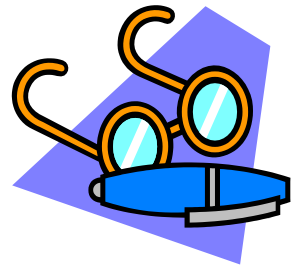

- It is a form of pneumonia and the bacterium (*Legionella pneumophila*);
- Temperature between 20 and 37°C , multiplication increases and is the greatest at 37°C.
- The bacteria was killed instantaneously at 70°C.
- Typically, the cooling water is at 27–32°C.
- Steps must be taken to prevent contaminant spray
- Drift eliminator to reduce the emission of water droplets from the outlet of a tower.
- Refer to government publication (**please read the document!**)

‘Code of Practice for the Prevention of Legionnaires’ Disease’

Consideration of using Cooling Towers

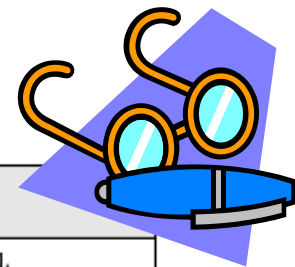

Legionnaires Disease

Legionella count (cfu/mL)	Indication	Required control strategy
Not detected (<10 cfu/mL)	System under control	(1) (a) Maintain quarterly monitoring. (b) Maintain water treatment programme.
Detected as ≥ 10 and <1,000 cfu/mL	Review programme	(2) (a) Investigate problem (b) Review water treatment programme (c) Take necessary remedial action including immediate on-line disinfection as described in section 3.3 and undertake control strategy (3)
		(3) Collect and test a water sample within 3 to 7 days after on-line disinfection (a) If not detected, collect and test another water sample. If 2 consecutive samples have no Legionella detected, repeat control strategy (1) (b) If detected at ≥ 10 and <100 cfu/mL repeat control strategy (2) (c) If detected at ≥ 100 and <1000 cfu/mL investigate problem and review water treatment programme, immediately carry out cleaning and disinfection again as described in section 3.4 and repeat control strategy (3) (d) If detected at $\geq 1,000$ cfu/mL, immediately carry out cleaning and disinfection as described in section 3.4 and undertake control strategy (5)
Detected as $\geq 1,000$ cfu/mL	Implement corrective action	(4) (a) Investigate problem (b) Review water treatment programme (c) Take necessary remedial action including immediate emergency decontamination as described in section 3.6 and undertake control strategy (5)

Consideration of using Cooling Towers

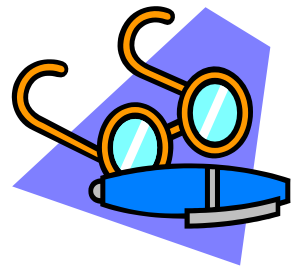

Legionnaires Disease

Legionella count (cfu/mL)	Indication	Required control strategy
		<p>(5) Collect and test a water sample within 3 days after emergency decontamination</p> <p>(a) If not detected, collect and test another water sample. If 2 consecutive samples have no Legionella detected, repeat control strategy (1)</p> <p>(b) If detected at ≥ 10 and < 100 cfu/mL, repeat control strategy (2)</p> <p>(c) If detected at ≥ 100 and $< 1,000$ cfu/mL investigate problem and review water treatment programme, immediately carry out cleaning and disinfection again as described in section 3.4 and repeat control strategy (5)</p> <p>(d) If detected at $\geq 1,000$ cfu/mL investigate problem and review water treatment programme, immediately carry out system emergency decontamination as described in section 3.6 and repeat control strategy (5)</p>

Consideration of using Cooling Towers

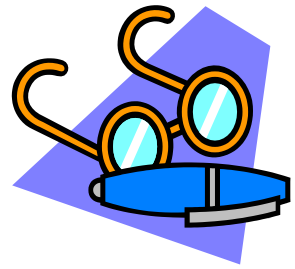

- Fresh Water Cooling Towers Scheme for Air Conditioning Systems (FWCT Scheme)
 - Pilot scheme launched in 2000, and converted to a standing scheme in 2008
 - Designated areas allow the use of cooling towers for heat rejection in chiller plants
 - Promote energy efficient water-cooled chillers
 - Guidelines can be obtained from EMSD website
<http://www.emsd.gov.hk/emsd/eng/pee/psfwct.shtml>

Definition of terms related Cooling Tower



Range: Difference between entering and leaving water temperature

Approach: Difference between leaving water temperature and entering air wet bulb temperature

Fill: Structure that forms the heat transfer surface within the cooling tower.

Water from the condenser or coil is distributed along the flow passages of the fill down to the water basin

Drift: Entrained water droplets carried off by the cooling tower

Bleed off (blowdown) : The removal of water from a cooling tower system to maintain the concentration of total dissolved solids and suspended

Makeup: Water added to the circulating water to compensate for the loss of water due to evaporation, drift, and blowdown

Definition of terms related Cooling Tower



Plume: Hot moist air discharged from the cooling tower forming a dense fog

Biocide : A physical or chemical agent that kills bacteria and other microorganisms.

Biodispersant : A chemical compound added to the water inside cooling tower system, to penetrate and break down any biofilm that may be present on the wetted surfaces of the cooling tower system.

Biofilm : A surface layer of microorganisms usually combined with particulate matter, scale and products of corrosion solids in an acceptable level.



Thermal Analysis of Cooling Tower

- v = Volume of the fill
- a = Surface area of fill per unit volume
- \dot{m}_w = Mass flow rate of water
- \dot{m}_a = Mass flow rate of air
- t = Temperature of water drop
- t' = Intermediate temperature of interfacial film of saturated air
- h' = Enthalpy of interfacial film of saturated air
- g' = Moisture content of interfacial film of saturated air
- t_a = Air temperature outside the interfacial film
- h_a = Enthalpy outside the interfacial film
- g_a = Moisture content outside the interfacial film
- K_s = Sensible heat transfer coefficient between the interfacial film and the air stream
- K_m = Convective mass transfer coefficient between the interfacial film and the air stream



Thermal Analysis of Cooling Tower

Note

$$t > t' > t_a$$

$$g' > g_a$$

$$h > h' > h_a$$

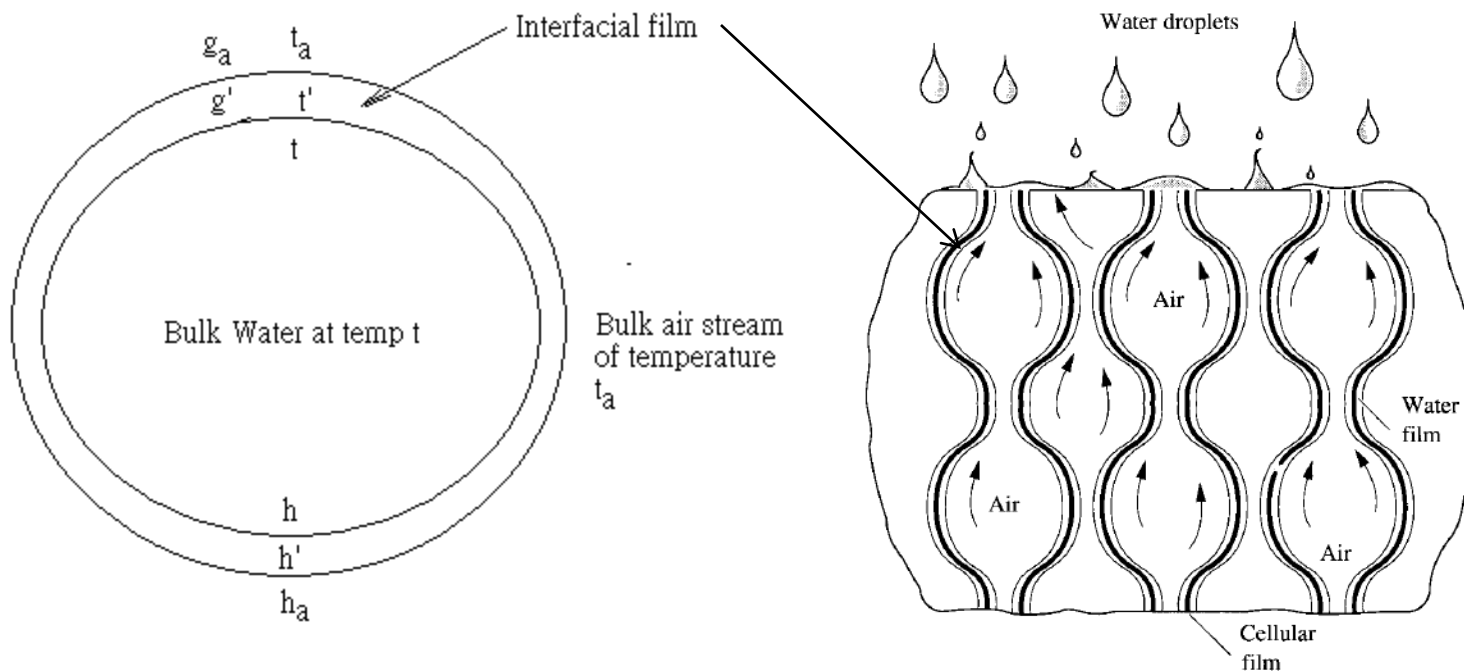



Thermal Analysis of Cooling Tower

Consider a cooling tower with the following characteristics: -

The sensible heat transfer from the interfacial film to the bulk air stream is given by:

$$dQ_s = K_s a dV (t' - t_a) \text{-----(1)}$$

And

The convective mass transfer of water vapour from saturated air film to the air stream:

$$dm = K_m a dV (g' - g_a) \text{-----(2)}$$



Thermal Analysis of Cooling Tower

Assuming latent heat of vaporization h_{fg} is a constant during this heat and mass transfer process,

the latent heat transfer from the vaporization of water at the interface is given by :-

$$dQ_e = h_{fg} d\dot{m} = h_{fg} K_m a dV (g' - g_a) \text{-----(3)}$$

The total heat transfer from water to the interfacial film may be expressed by: -

$$dQ_w = dQ_s + dQ_e = \dot{m}_w c_{pw} dt_w = [K_s (t' - t_a) + h_{fg} K_m (g' - g_a)] a dV \text{-----(4)}$$

where c_{pw} = specific heat of water (=a constant with value 4.2kJ/kg.K)



Thermal Analysis of Cooling Tower

It should be noted that convective mass transfer coefficient

$$K_m \approx \frac{K_s}{c_{pa}} \text{-----(5)}$$

where c_{pa} = specific heat of air c_{pa}

By putting (5) into (4),

$$\begin{aligned} \dot{m} c_{pw} dt &= [c_{pa} (t' - t_a) + h_{fg} (g' - g_a)] K_m adV \\ &= [(c_{pa} t' + h_{fg} g') - (c_{pa} t_a + h_{fg} g_a)] K_m adV \text{----(6)} \end{aligned}$$



Thermal Analysis of Cooling Tower

Since $c_{pa} = c_{pd} + g \cdot c_{ps}$

Where c_{pd} and c_{ps} are specific heat of dry air and water vapour and g is moisture content.

The enthalpy of the saturated air film h' can be calculated as

$$h' = c_{pa}t' + h_{fg}g' \text{-----} (7)$$

The enthalpy of air stream h_a is: -

$$h_a = c_{pa}t_a + h_{fg}g_a \text{-----} (8)$$

Putting (7) and (8) into equation (6), we get

$$\dot{m}c_{pw}dt = (h' - h_a)K_m adV \text{-----} (9)$$



Thermal Analysis of Cooling Tower

Integrating from water leaving t_{w1} to water entering temperature t_{w2} gives: -

$$\int_{t_{w1}}^{t_{w2}} \frac{dt}{(h' - h_a)} = \int_0^V \frac{K_m a dV}{\dot{m}_w c_{pw}} \text{-----(10)}$$

Let the overall heat transfer coefficient $K_a = \frac{K_m}{c_{pw}}$, then

$$\int_{t_{w1}}^{t_{w2}} \frac{dt}{(h' - h_a)} = \frac{K_a a V}{\dot{m}_w} \text{-----(11)}$$

By using numerical integration, the tower coefficient is:

$$\frac{K_a a V}{\dot{m}_w} = \frac{(t_{w2} - t_{w1})}{(h' - h_a)}$$

$\frac{K_a a V}{\dot{m}_w}$ is also known as number of transfer units NTU of a cooling tower or 'tower coefficient'.



Thermal Analysis of Cooling Tower

Tower Coefficient is a function of the water-air ratio (i.e. \dot{m}_w / \dot{m}_a)(experimental results).

The construction of the fill and is directly proportional to the height of the fill H.

The correlation may be expressed as the following equation: -

$$\frac{KaV}{\dot{m}_w} = C + H\dot{m}_w^n + \dot{m}_a^m$$

where $-0.65 < n < -0.55$, usually -0.6

m is positive value with absolute value slightly greater than n.

(note that there can be other empirical correlations but the water/air ratio and the height of the fill remain as functions of the tower coefficient)

Heat and Mass transfer process between condenser water and air

- Entering air at a temperature higher than the leaving water temperature
- Air is evaporatively cooled under air temperature approaches water temperature
- Air is humidified and heated
- Observe that the driving potential is the difference in enthalpy
- Sensible heat transfer ~5%

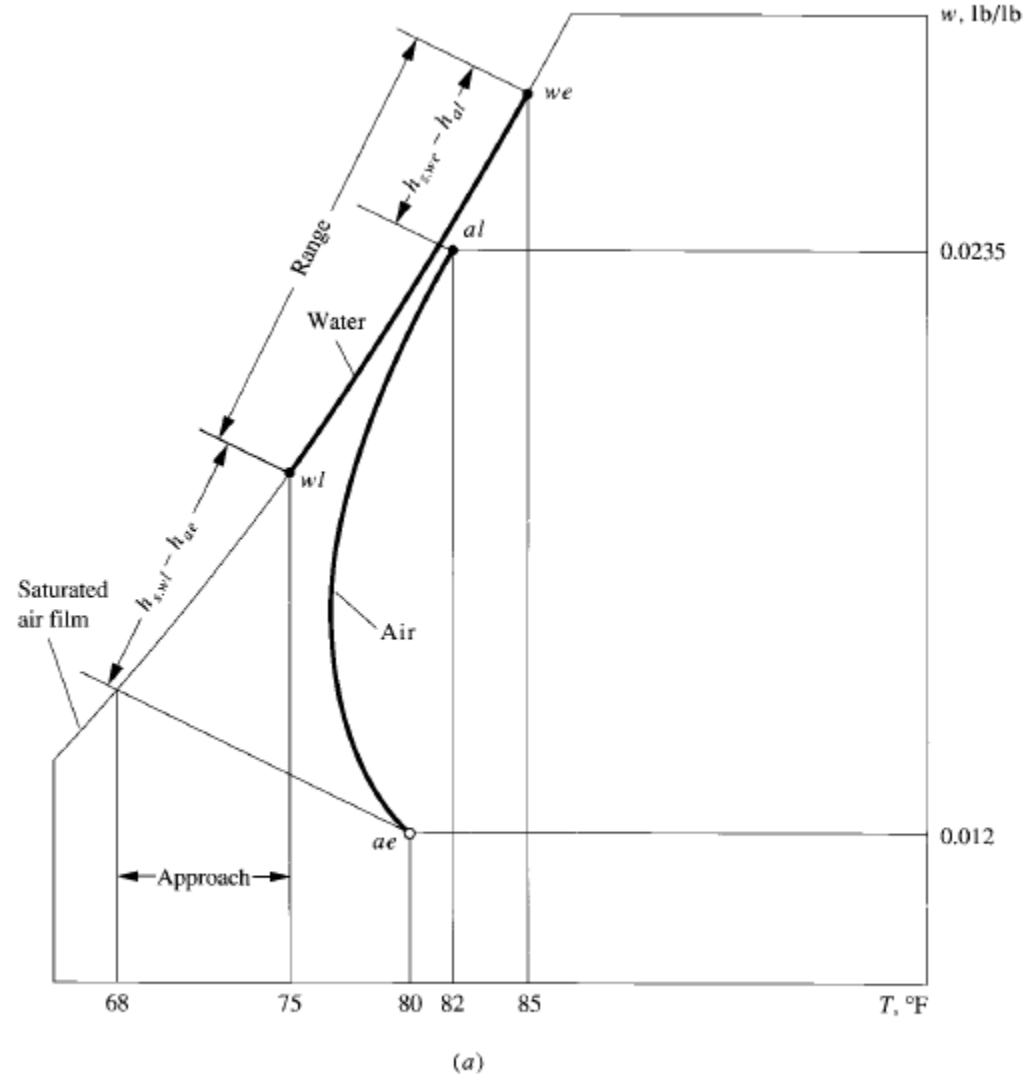

FIGURE 10.14 Heat- and mass-transfer process for a counterflow cooling tower: (a) entering air at 80°F dry-bulb and 68°F wet-bulb temperature.

Heat and Mass transfer process between condenser water and air

- Entering air at a temperature lower than the leaving water temperature
- Humidity is high (representing a rainy day)
- Air is humidified and heated
- Observe that the driving potential is the difference in enthalpy
- Sensible heat transfer ~23%

