

Space Air Diffusion I



Ir Dr. Sam C. M. Hui

Department of Mechanical Engineering

The University of Hong Kong

E-mail: cmhui@hku.hk

Contents



- Basic Principles
- Air Jets
- Outlets and Inlets
- Mixing Flow
- Design Issues



Basic Principles

- Objective of space air diffusion
 - Evenly distribute conditioned & outdoor air to provide healthy & comfortable indoor environment, or appropriate environment for process, at optimum cost
- Last process of air conditioning
 - Take place entirely within conditioned space
 - Directly affect the occupants, but it is difficult to trace & quantify



Basic Principles

- Important considerations:
 - Thermal comfort (temp., humidity, air velocity)
 - Comfort conditions, local variations
 - Indoor air quality
 - Airborne pollutants
 - Ventilation effects
 - Noise control
 - Noise criteria, sound attenuation
- Occupied zone: 1.8 m from floor

Air supply and return for a room

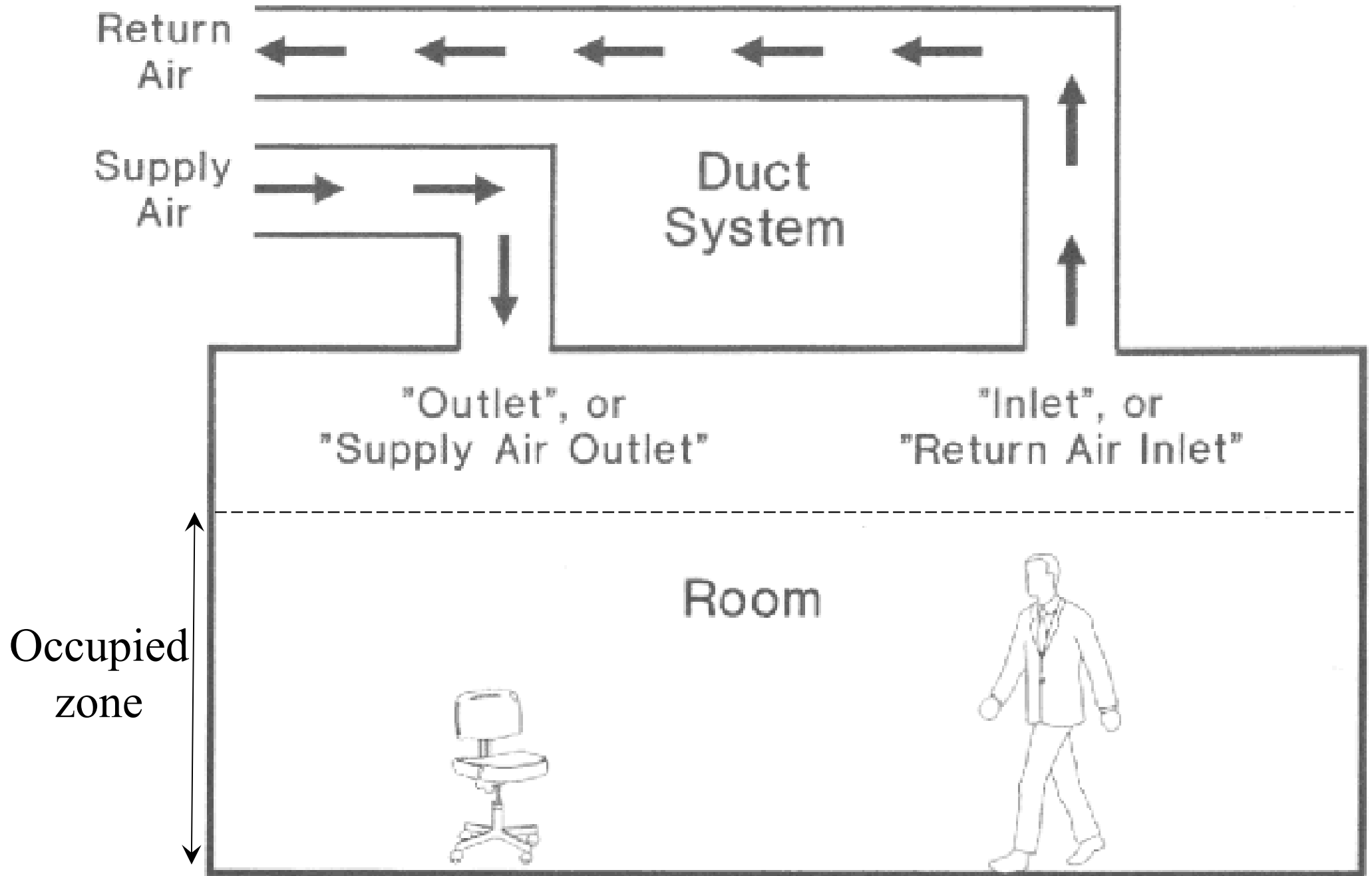



Basic Principles

Thermal Comfort

- Draft & effective draft temperature

- Draft: unwanted local cooling of human body caused by air movement & lower space air temp.
- Turbulence intensity, $I_{\text{tur}} = \sigma_v / v_m$
 - σ_v = standard deviation of air velocity fluctuation (m/s)
 - v_m = mean air velocity (m/s)
- Effective draft temperature: combines effects of uneven space air temp. & air movement
 - $\theta = T_x - T_r - a (v_x - v_{rm})$

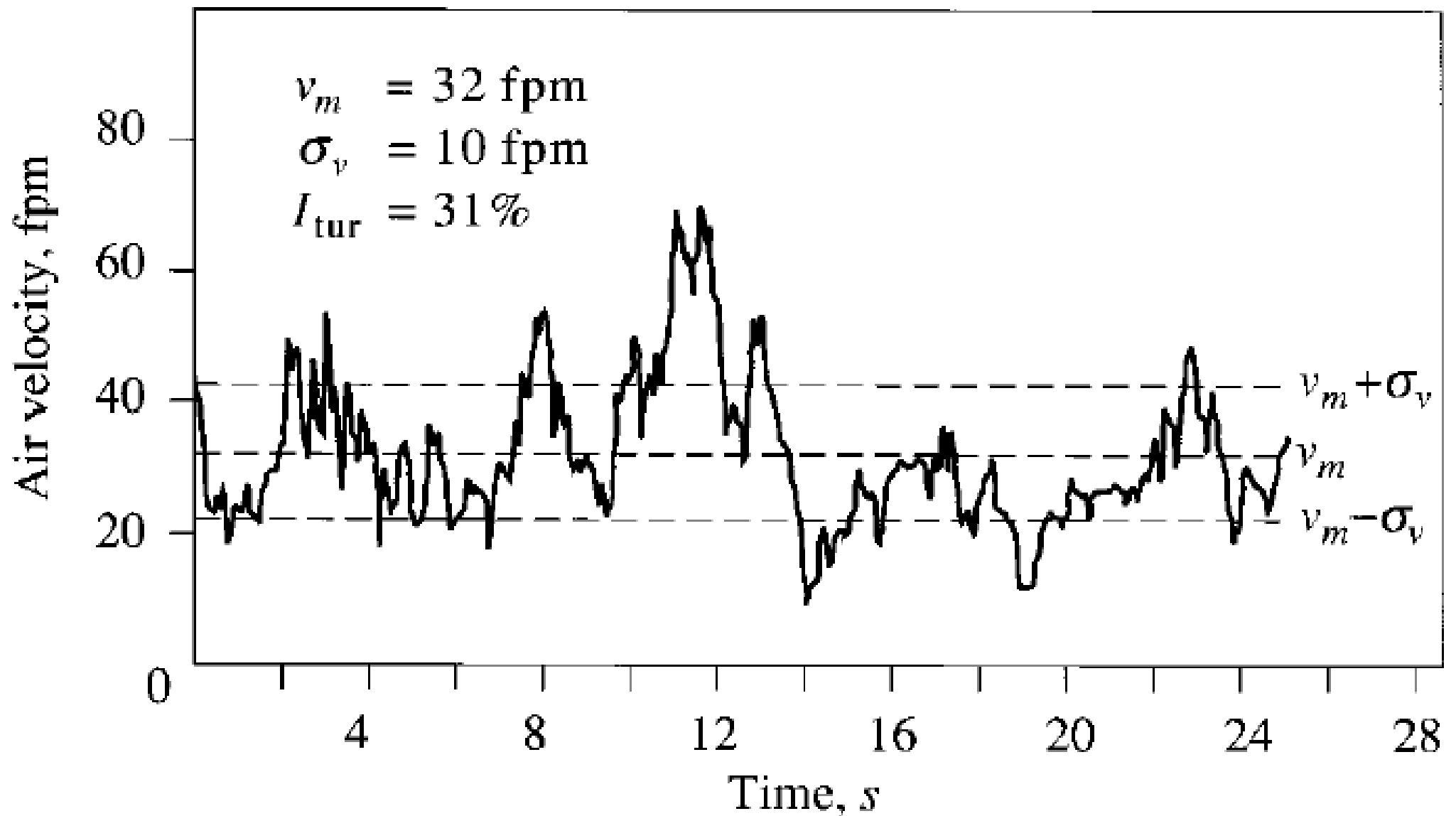

FIGURE 18.1 Fluctuations of air velocity in a typical air conditioned space. (Adapted with permission from *ASHRAE Journal*, April 1989, p. 30.)



Basic Principles

- Air diffusion performance index (ADPI)
 - $ADPI = (N_{\theta} \times 100) / N$
 - θ : effective draft temperature
 - N_{θ} : number of points measured in occupied zone in which $-1.7 \text{ }^{\circ}\text{C} < \theta < 1.1 \text{ }^{\circ}\text{C}$
 - N : total number of points measured in occupied zone
 - Higher the ADPI, higher % of occupants who feel comfortable
 - ADPI is useful for cooling mode operation
 - For heating mode, temperature gradient % 2 points may be a better indicator of thermal comfort ($< 2.8 \text{ }^{\circ}\text{C}$ typical)



Basic Principles

- Air exchange rate
 - = Volume flow rate / interior volume
 - Unit: L/s or air change per hour (ACH)
 - May consider outside air, or supply air
- Time constant (τ)
 - Inverse of air exchange rate
- Air diffusion effectiveness
 - Perfectly mixing, perfectly displacing
 - Degree of effectiveness of air diffusion



Basic Principles

- Space diffusion effectiveness factor
 - For air temperature or air contamination

$$\varepsilon_T = \frac{T_{re} - T_s}{T_r - T_s} = \frac{T_{ex} - T_s}{T_r - T_s}$$

$$\varepsilon_C = \frac{C_{ex} - C_s}{C_r - C_s}$$

- Subscript: re = recirculating air; ex = exhaust air; r = space air; s = supply air
- Effective if $\varepsilon = 1$; not so if $\varepsilon < 1$



Basic Principles

- Ventilation effectiveness
 - Air system's ability to remove internally generated contaminants from a zone, space or building
- Age of air θ_{age} (in minutes or hours)
 - Time period that outdoor ventilation air has been in a zone, space or building
 - Evaluated using tracer gas method
 - The “youngest” air = freshest air



Basic Principles

- Air change effectiveness ε_N
 - Air system's ability to deliver ventilation air
 - How well outdoor air is diffused to various locations
 - $\varepsilon_N = \tau_N / \theta_{\text{age}, N}$
 - τ_N : nominal time constant (min. or hr.)
 - ACH = supply volume flow rate / space volume
 - $\tau_N = 1 / \text{ACH}$
 - For proper air distribution system, $\varepsilon_N \approx 1$

Air Jets



- Air jets
 - Airstream discharge from an outlet with significantly higher velocity than surrounding
 - Move along its centreline until terminal velocity reduces to velocity of ambient air
 - Envelope = outer boundary of air jet
 - Common classifications
 - Free or confined
 - Isothermal or non-isothermal
 - Axial or radial

Air Jets



- Air jets
 - Free air jet: envelope not confined by enclosure
 - Confined air jet: envelope confined by ceiling, floor, walls, windows, furniture, etc
 - Air jet approaches a free air jet if $\sqrt{A_r} / D_o > 50$
 - A_r = cross-sectional area of the enclosure perpendicular to the air jet centreline
 - D_o = diameter or circular equivalent of supply outlet
 - Isothermal jets: whose temperature is equal to the ambient air (c.f.: non-isothermal jets)

Four zones of a free, isothermal, axial air jet

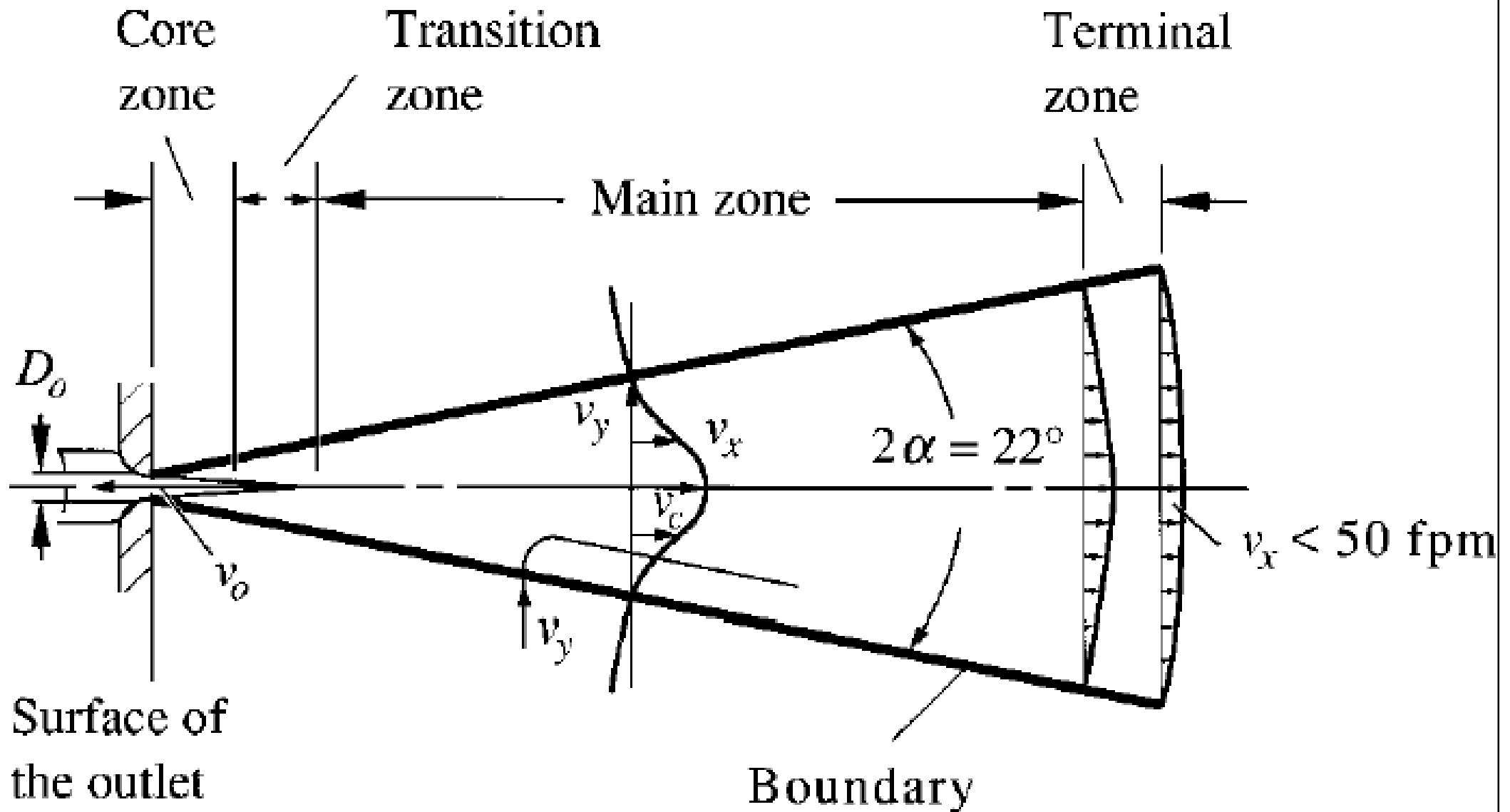

Zones of expansion for axial or radial air jets

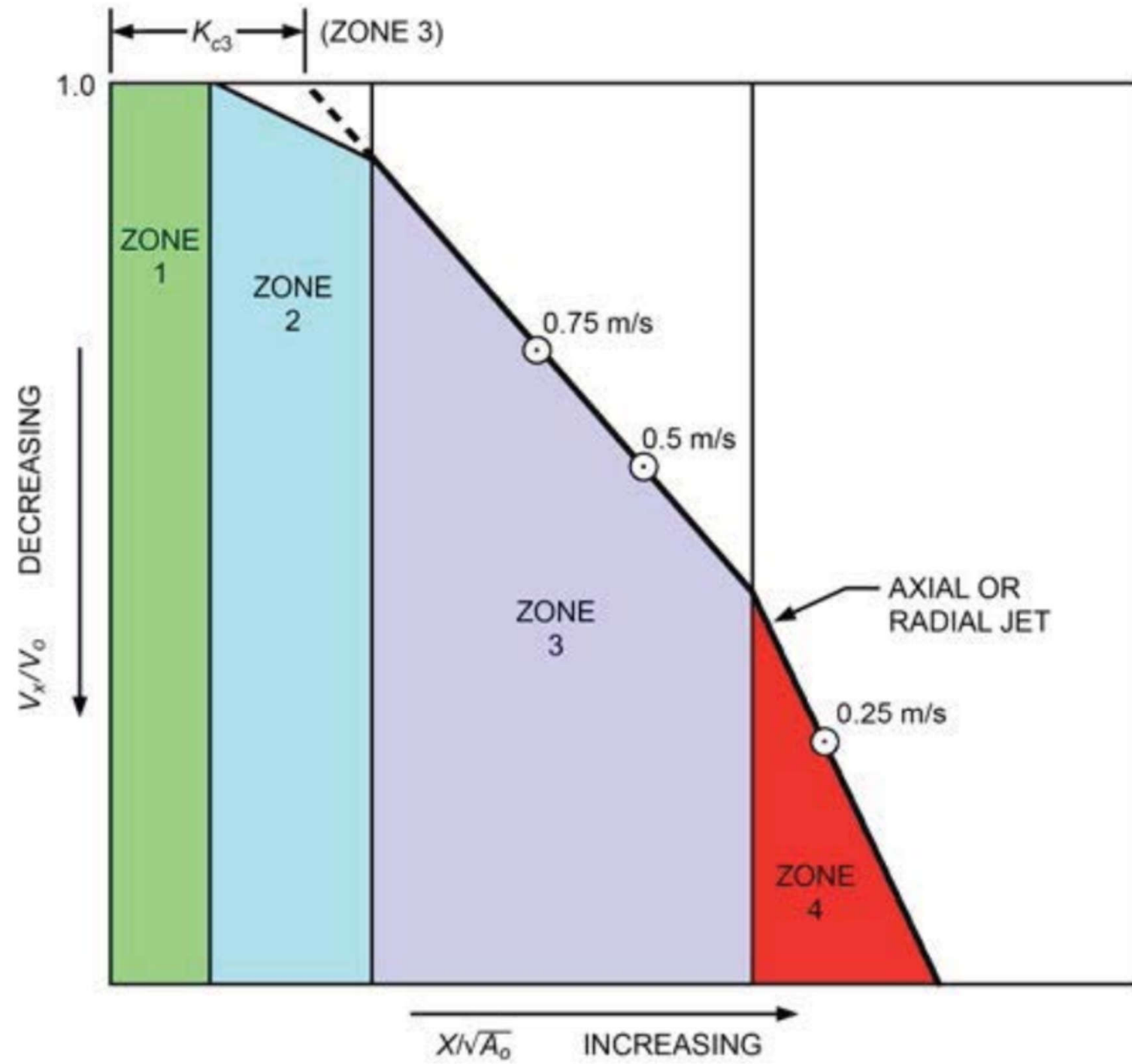

Air Jets



- Free isothermal jets
 - Core zone
 - Centreline velocity remains unchanged
 - Extends about $4 D_o$ from the outlet
 - Transition zone
 - Centreline velocity decreases inversely w/ square root of distance from outlet
 - Extends about $8 D_o$ from the outlet
 - Main zone
 - Turbulent flow is fully developed
 - Extends about $25-100 D_o$ from the outlet
 - Terminal zone
 - Max. air velocity decreases rapidly to less than 0.25 m/s

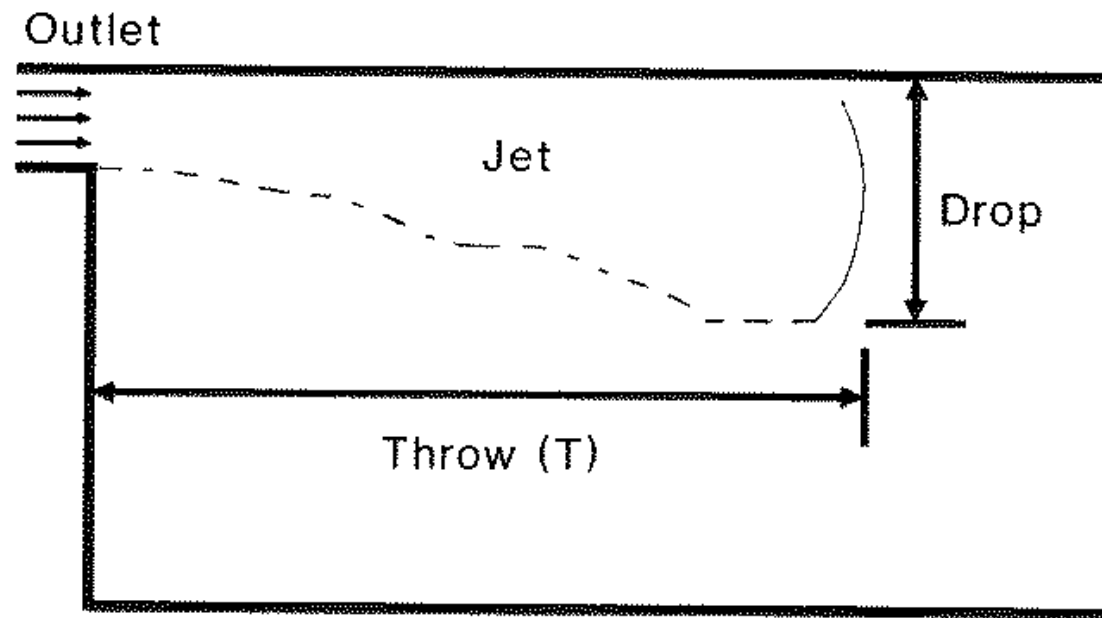

Section View

Air jet
terminology

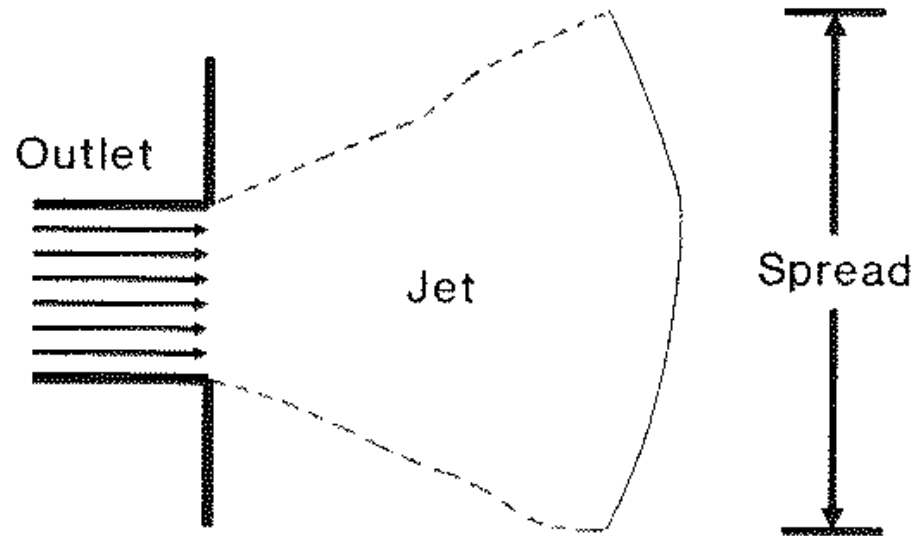

Plan View

Air Jets



- Throw, T_v (m)

- Horizontal or vertical axial distance from outlet to a cross-sectional plane where max. velocity of airstream at the terminal zone has been reduced to 0.25, 0.5, or 0.75 m/s

$$T_v = \frac{K' \times \dot{V}_s}{v_{t,\max} \sqrt{A_c C_d R_{fa}}}$$

K' = centreline velocity constant

\dot{V}_s = supply volume flow rate

$v_{t,\max}$ = max. velocity at terminal zone

A_c = core area of outlet

C_d = discharge coefficient

R_{fa} = ratio of free area to gross area

Air Jets



- Entrainment ratio

- Ratio of volume flow rate to the total air at a specific cross-sectional plane of the air jet to volume flow rate of the supply air discharged from outlet (primary air)
- Total air = sum of supply air and induced air
- Proportional to the distance or square root of the distance from outlet

Air Jets



- Characteristic length, L
 - Horizontal distance from outlet to the nearest vertical opposite wall, or to the midplane between 2 outlets in the direction, OR the distance to the closest intersection of air jets
 - Ratio of T_v/L is related to ADPI of various supply outlets and has been used a parameter in space diffusion design

Table 3. Characteristic Length for Various Diffuser Types

Diffuser Type	Characteristic Length, L
High Sidewall Grille	Distance to wall perpendicular to jet
Circular Ceiling Diffuser	Distance to closest wall or intersecting air jet
Sill Grille	Length of room in the direction of the jet flow
Ceiling Slot Diffuser	Distance to wall or midplane between outlets
Light Troffer Diffusers	Distance to midplane between outlets, plus distance from ceiling to top of occupied zone
Perforated, Louvered Ceiling Diffusers	Distance to wall or midplane between outlets



Air Jets



- Confined air jets (in practical cases)
 - Surface effect (or Coanda effect)
 - Primary airstream from supply outlet flows along a surface (at high velocity)
 - A lower pressure region is formed near the surface
 - Induced ambient air presses the air jet to the surface
 - Friction between airstream & boundary
 - Decreases the centreline velocity of the air jets
 - With the surface effect, throw of a confined air jet is longer, drop from horizontal axis smaller than that of a free air jet

(See also: What is coanda effect and why it is important to HVAC supply air diffusers selection?

<https://www.practicalhvac.com/air-conditioning/coanda-effect/>)

Surface effect (or Coanda effect)

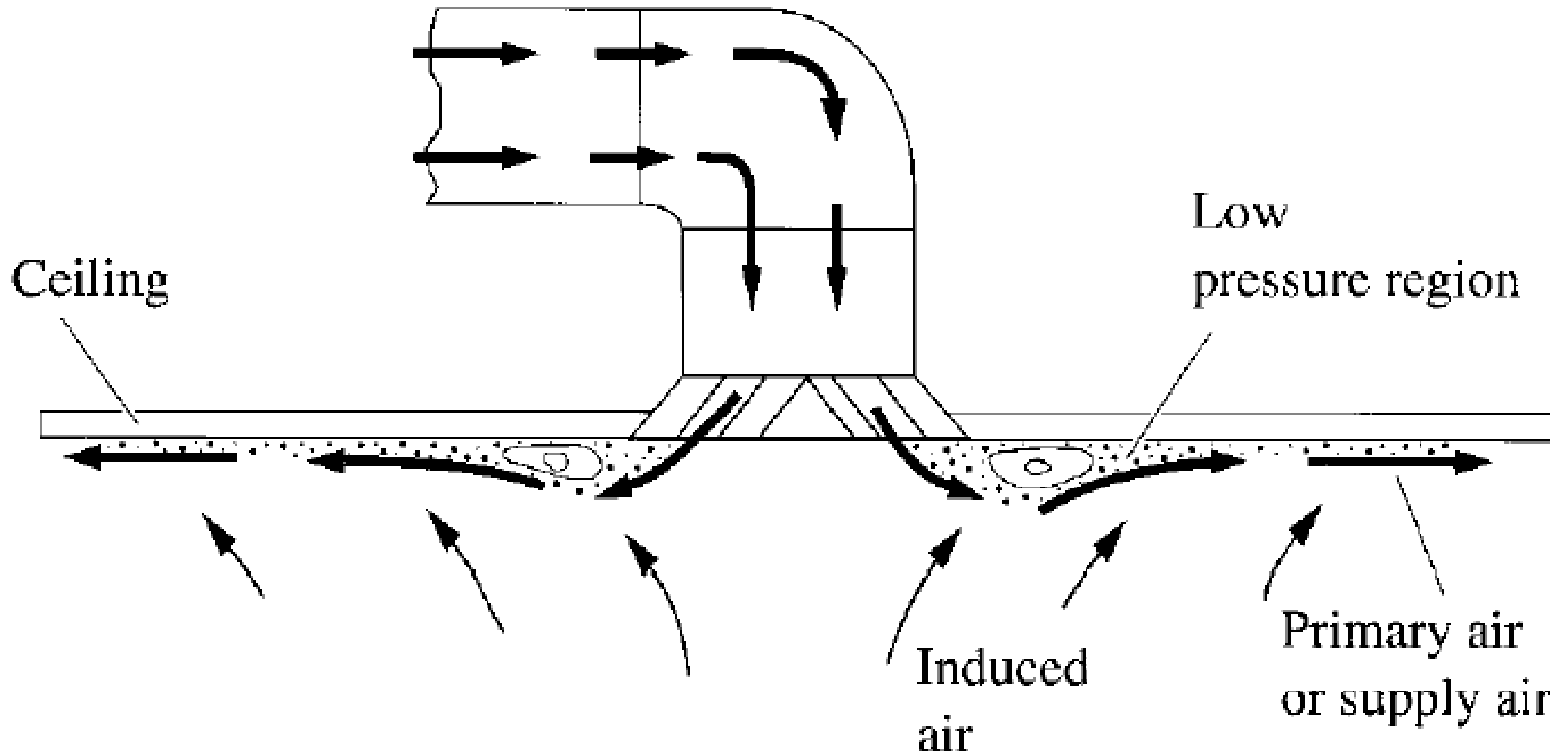

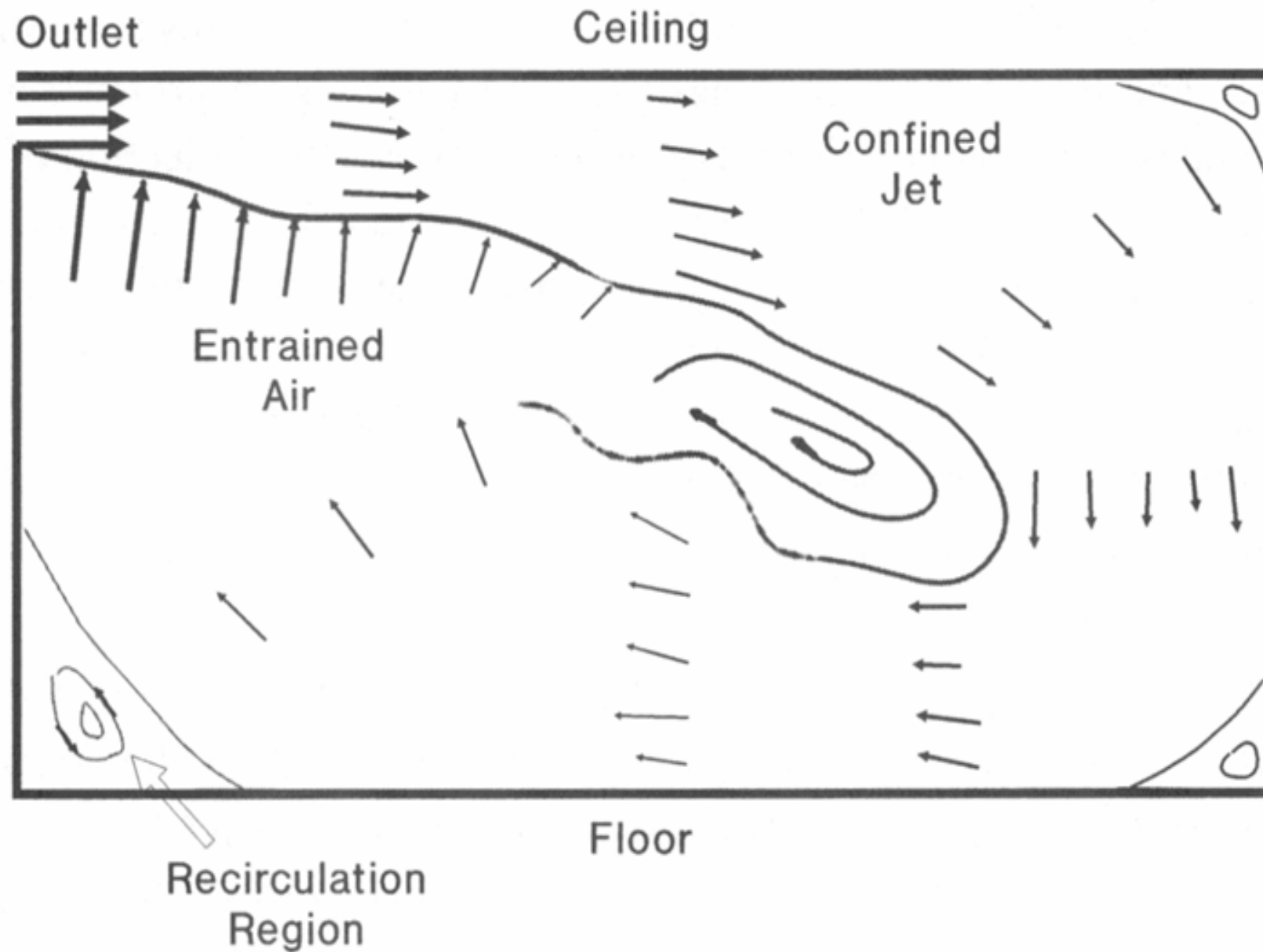
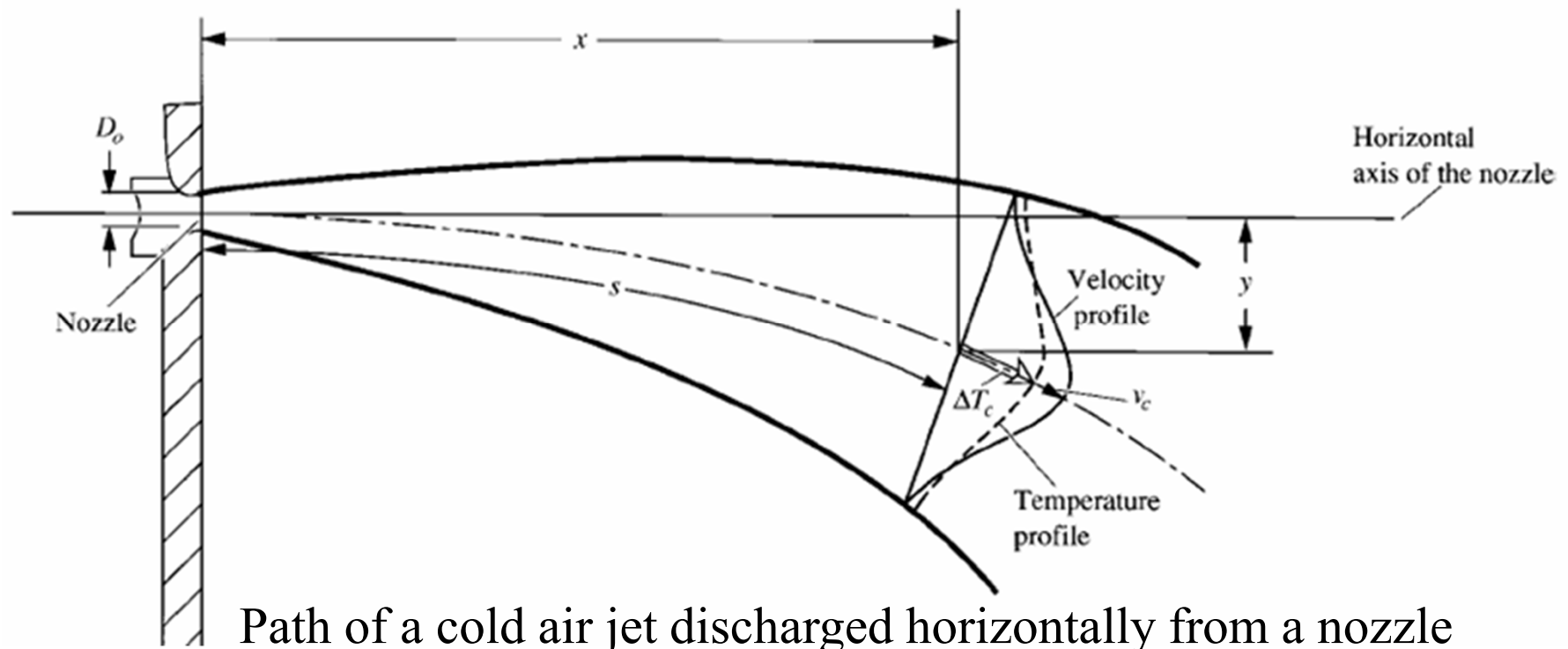

Figure 5.11 *Because a real room has a limited volume, a jet's growth and shape are affected. A "confined jet" is the result.*



Air Jets

- Free nonisothermal jets
 - Supply air at different temp. from ambient air
 - Buoyancy of air causes trajectory of the air jet



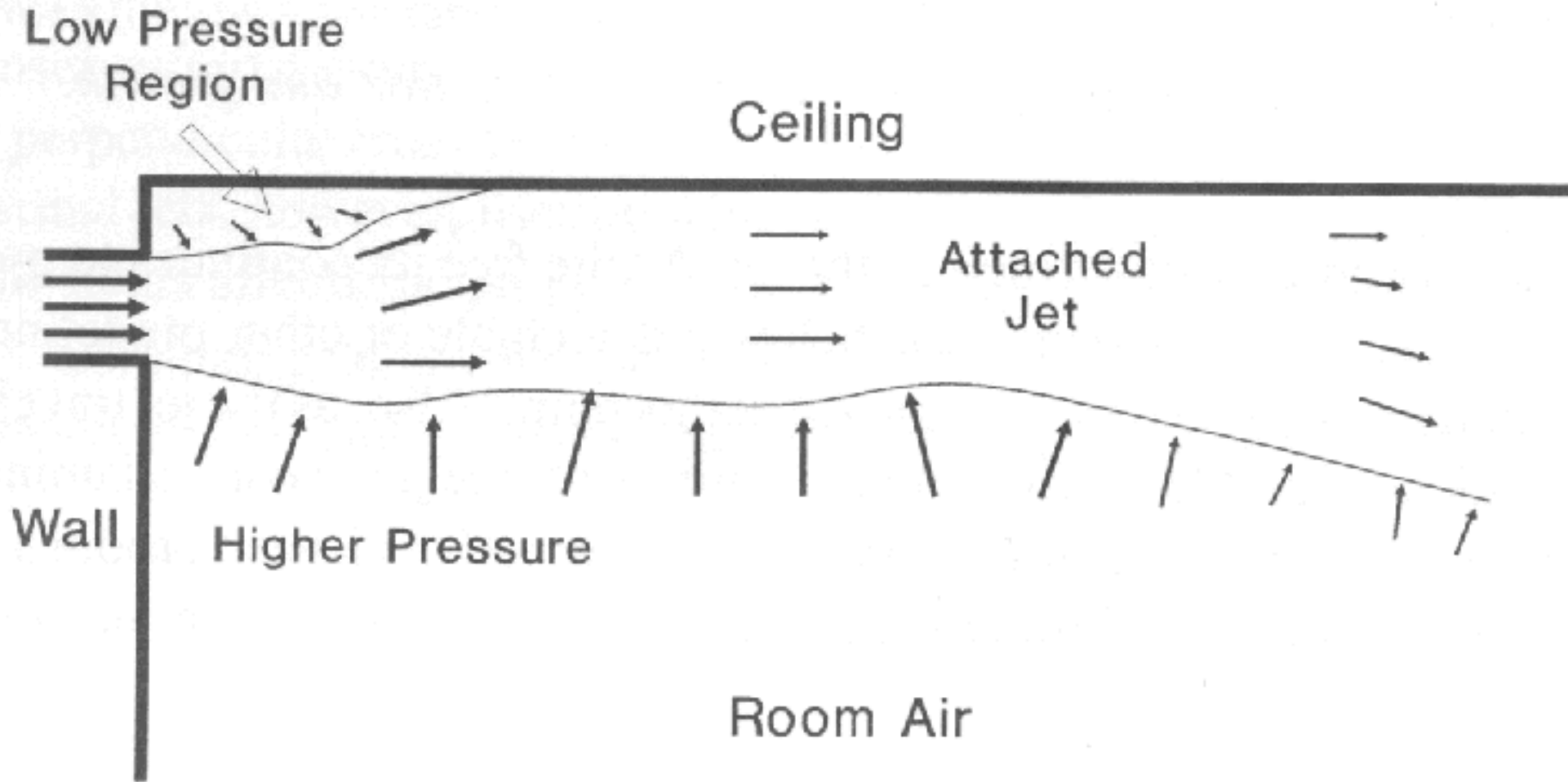

Figure 5.9 *A jet attaches to a surface like a ceiling because entrainment is limited on that side.*

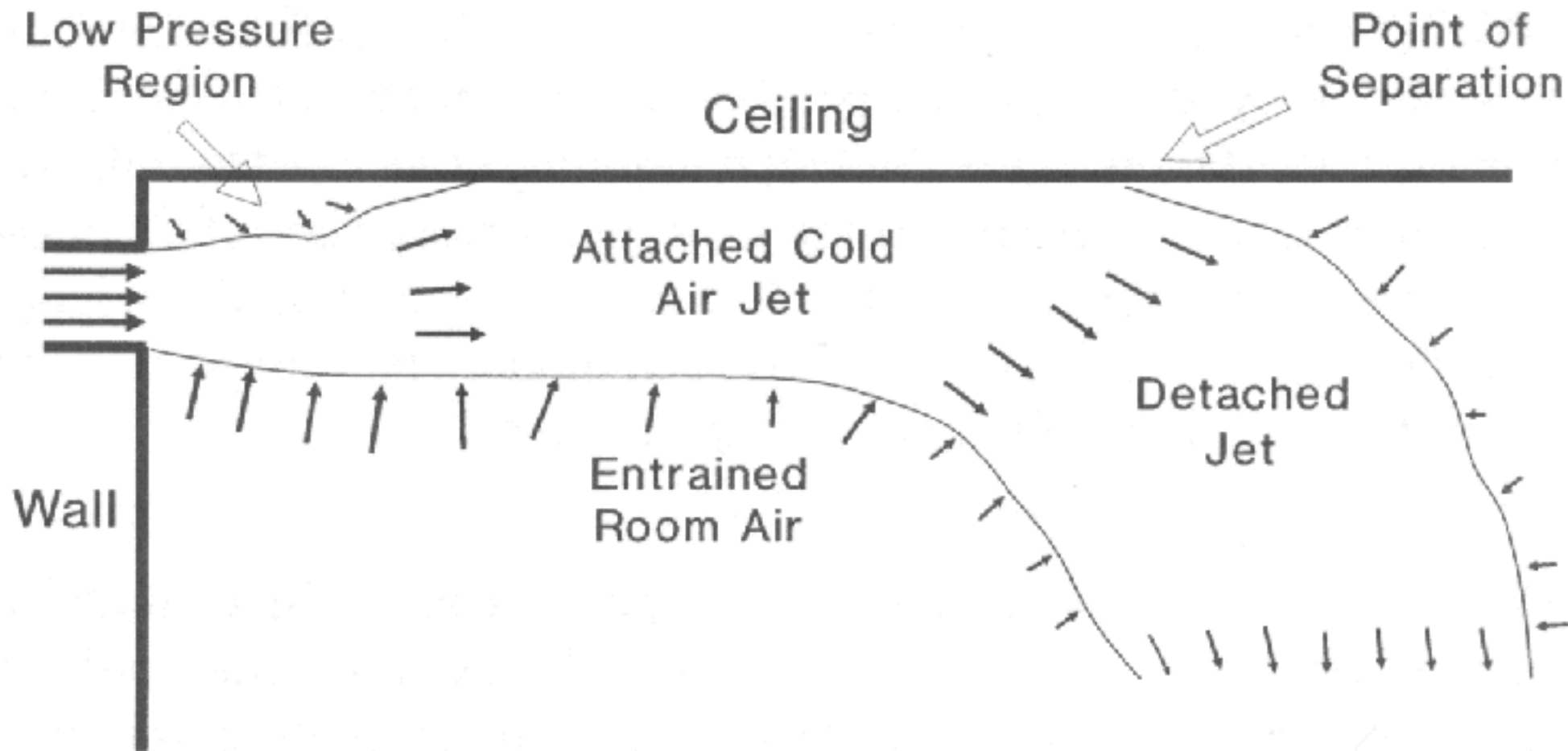
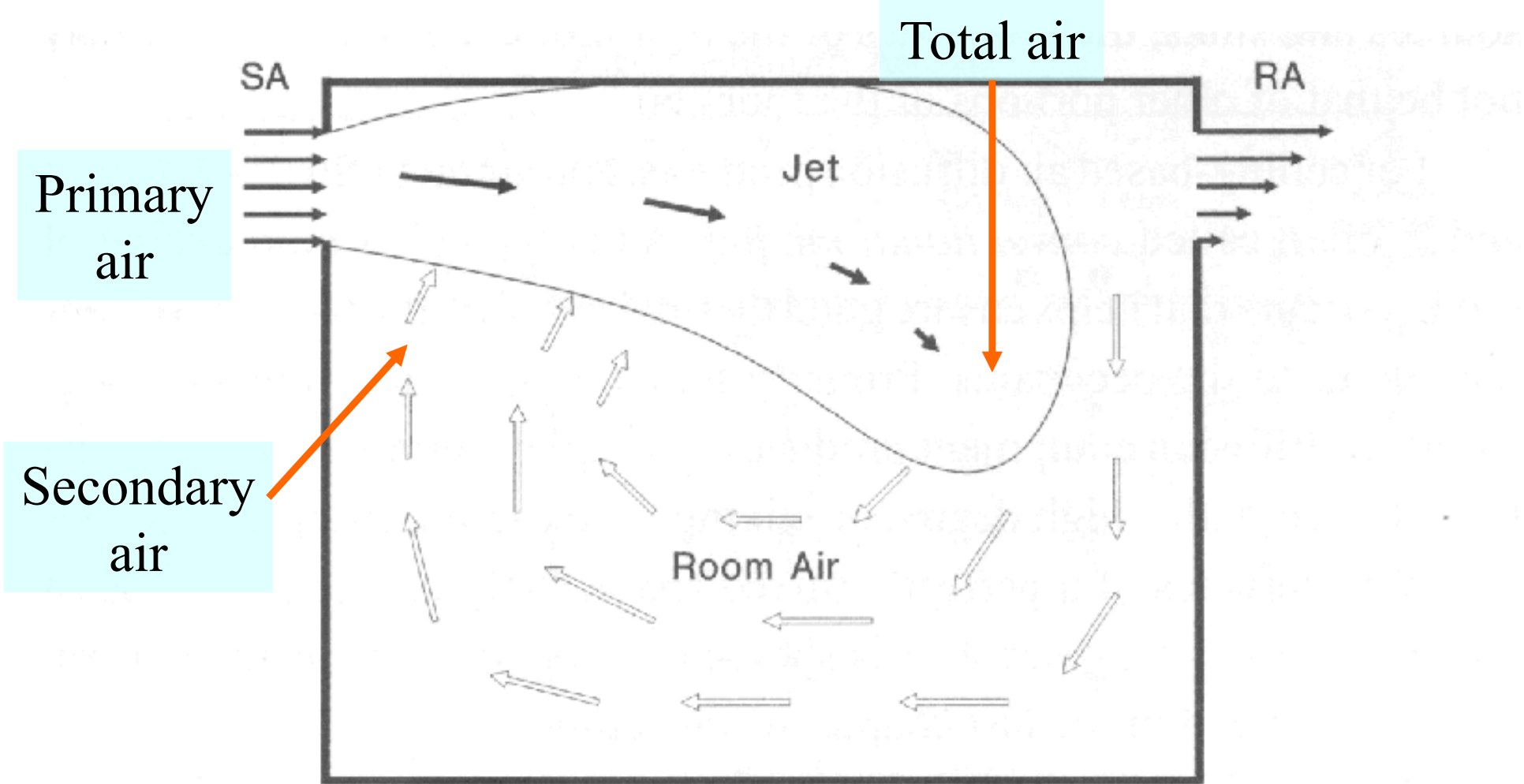

Figure 5.10 *If a cool air ceiling jet slows to the point that negative buoyancy overcomes the force causing attachment, the jet detaches from the ceiling.*



"Entrainment" or "Conventional-Mixing" Flow

Figure 6.2 *Real airflows in rooms are most often "entrainment flow" or "conventional mixing" where confined jets and surfaces affect the resulting pattern.*

(Source: Rock, B. A. and Zhu, D., 2002. *Designer's Guide to Ceiling-based Air Diffusion*.)

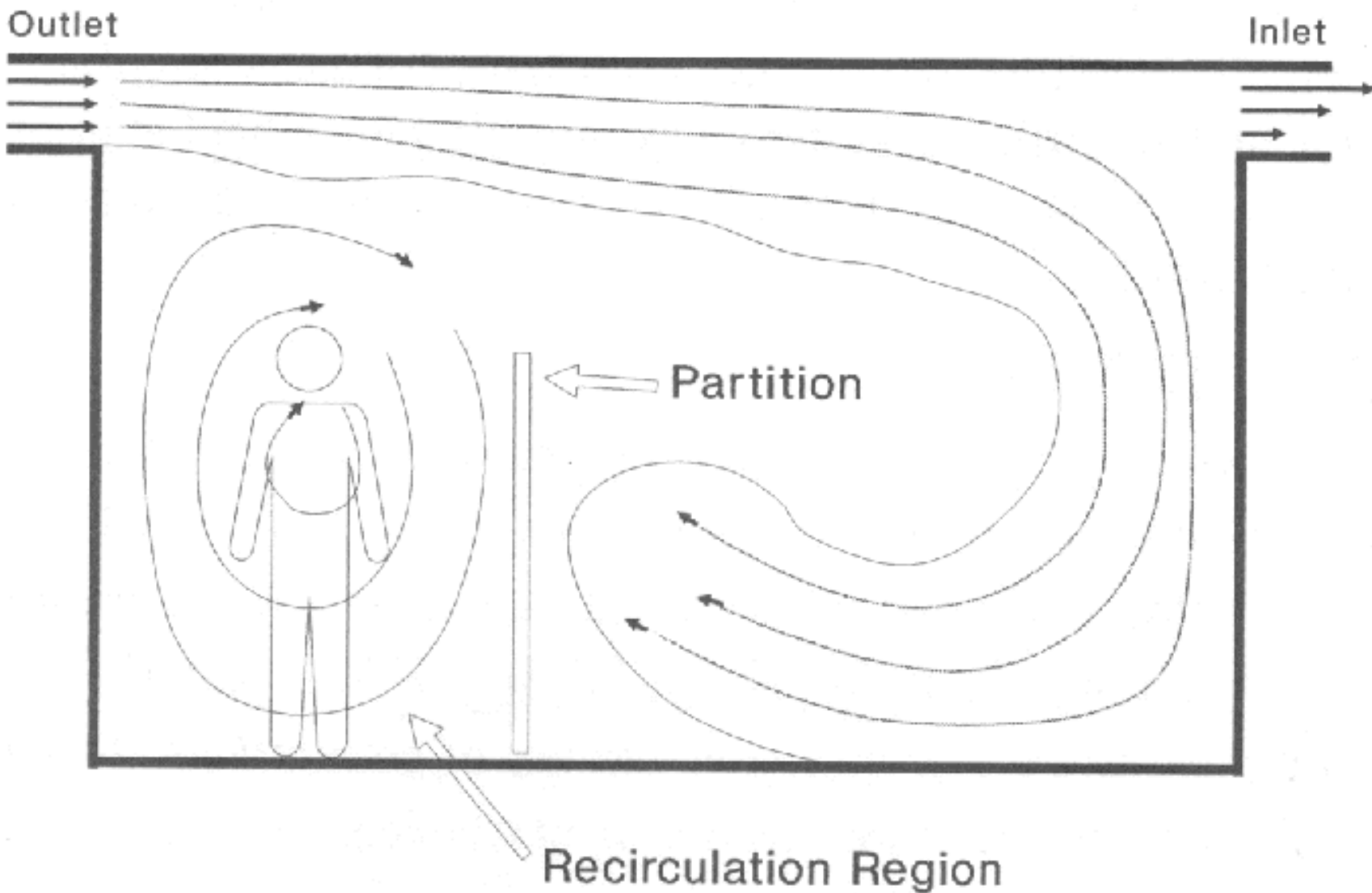

Figure 6.3 *Recirculation regions often form due to limiting objects and surfaces within spaces, or the characteristics of the jet and the room.*

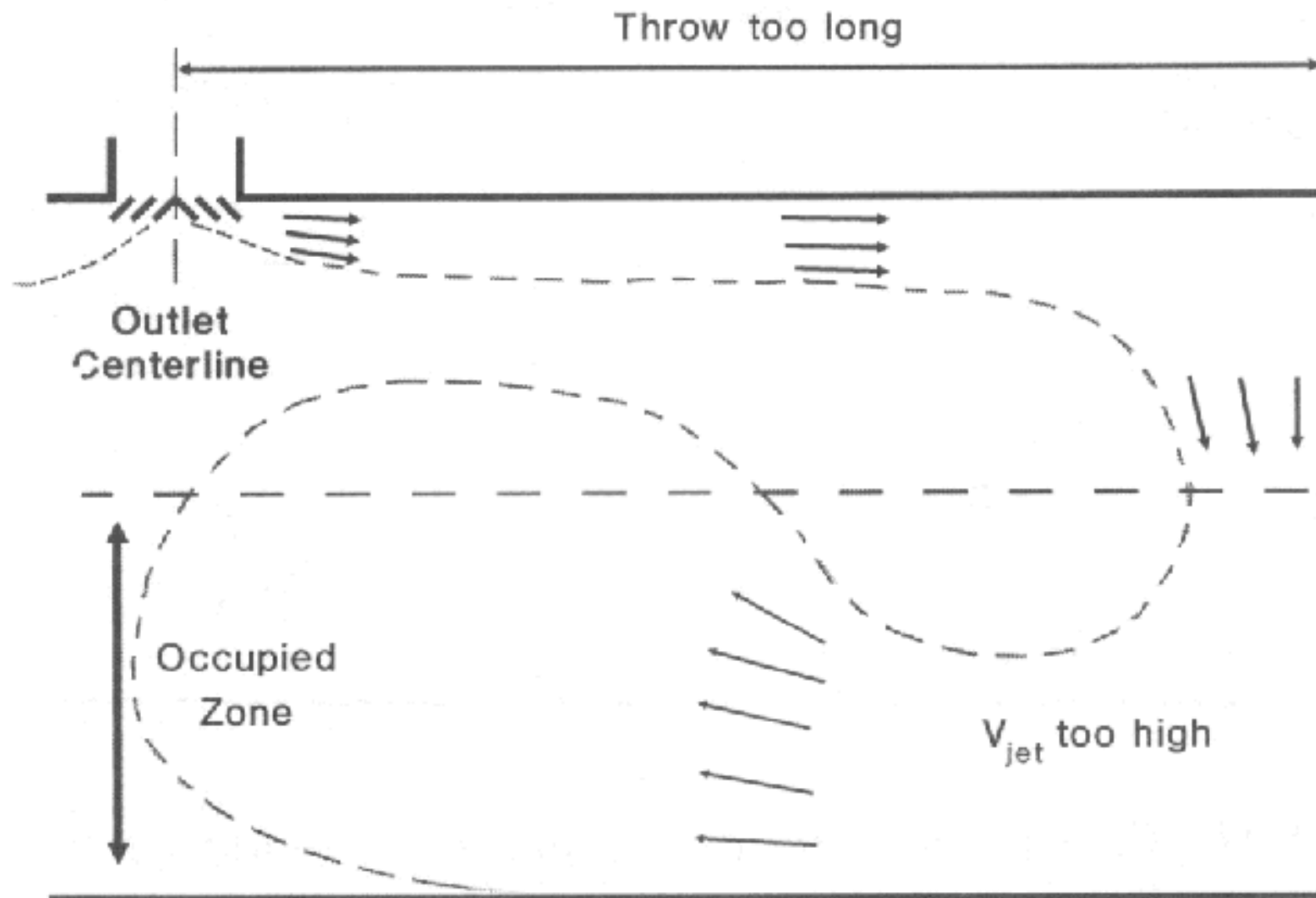

Figure 6.9 When a jet's throw is too long, the velocity and the temperature of the air entering the occupied zone may be objectionable.

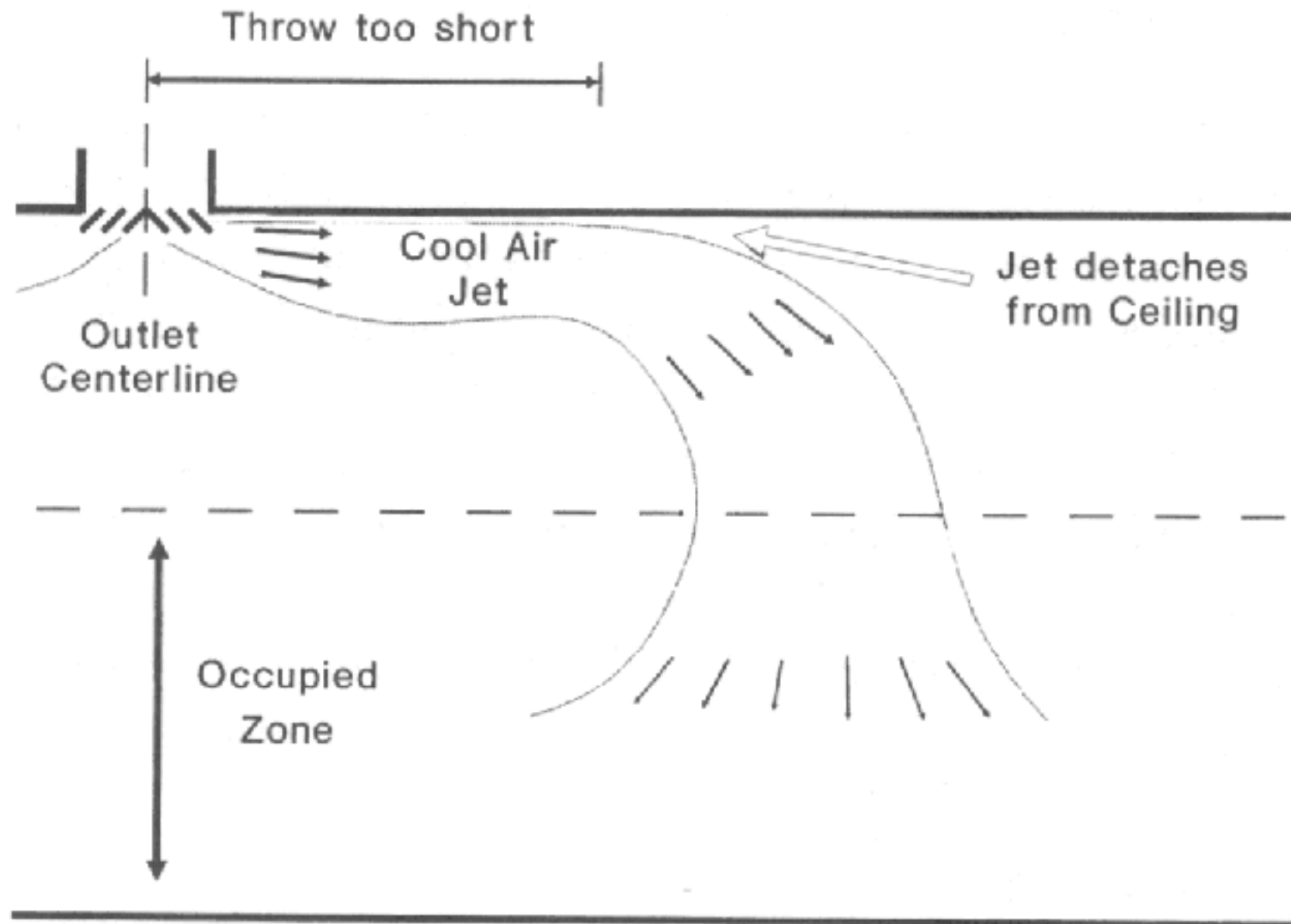

Figure 6.10 “Dumping” is when a jet enters the occupied zone and is objectionable. Detachment is one potential cause of dumping, and can be created by too little airflow and/or an oversized outlet.

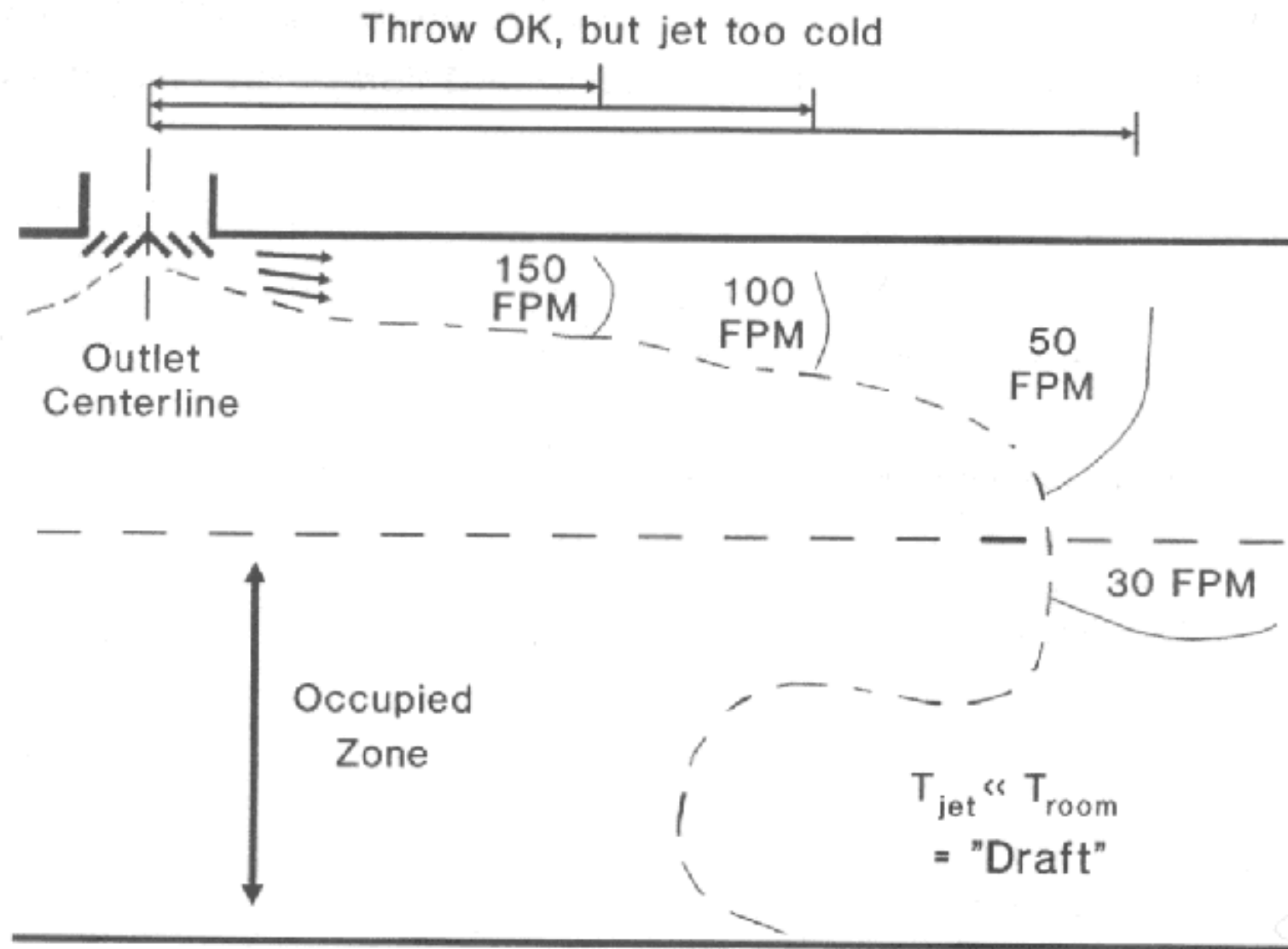

Figure 6.11 Even if velocities are acceptable, too large a temperature difference between the jet and the room air can also cause "draft" complaints.



Outlets and Inlets

- Supply outlets
 - Grilles and registers
 - Ceiling diffusers
 - Slot diffusers
 - Nozzles
- Return & exhaust inlets
- Light troffer diffuser & troffer-diffuser slot
- Design issues: architectural setup, airflow pattern needed, indoor requirements, load conditions

Supply grille and register

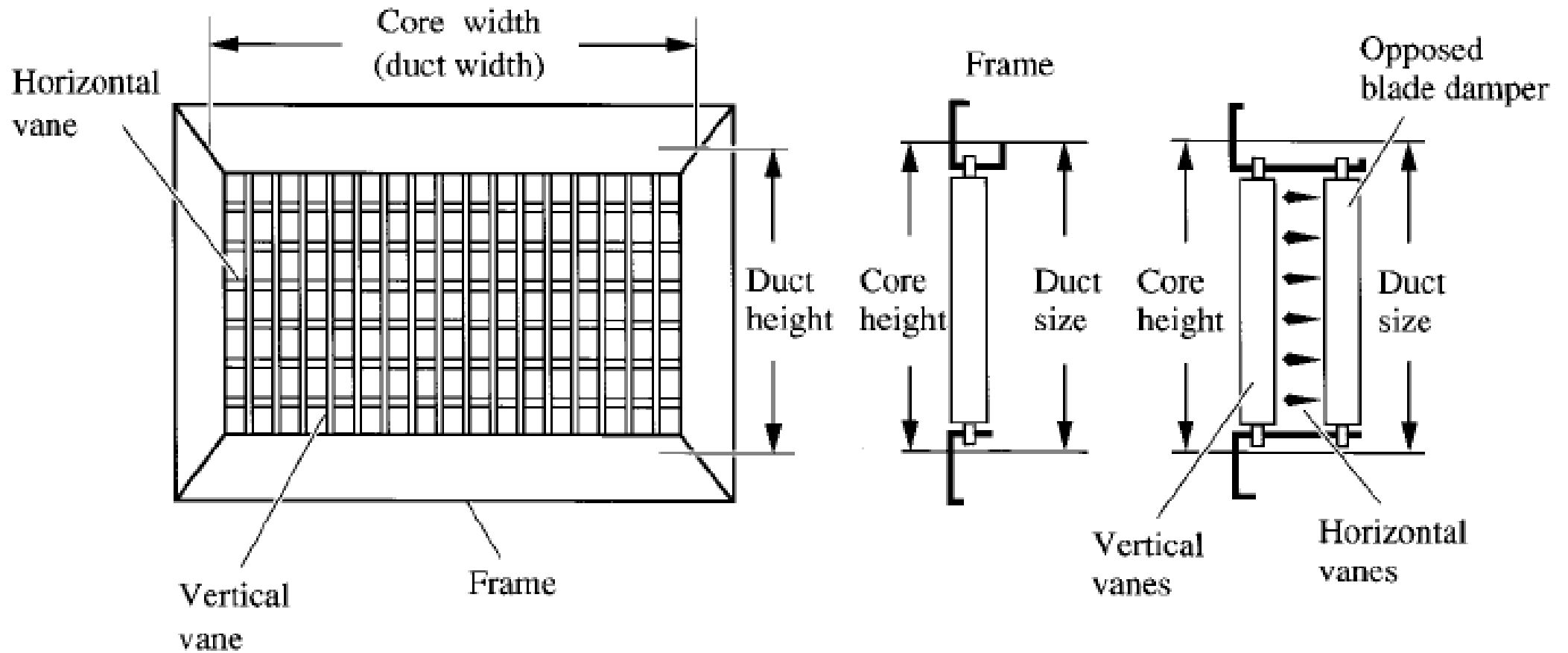

Airflow patterns of high sidewall supply grilles

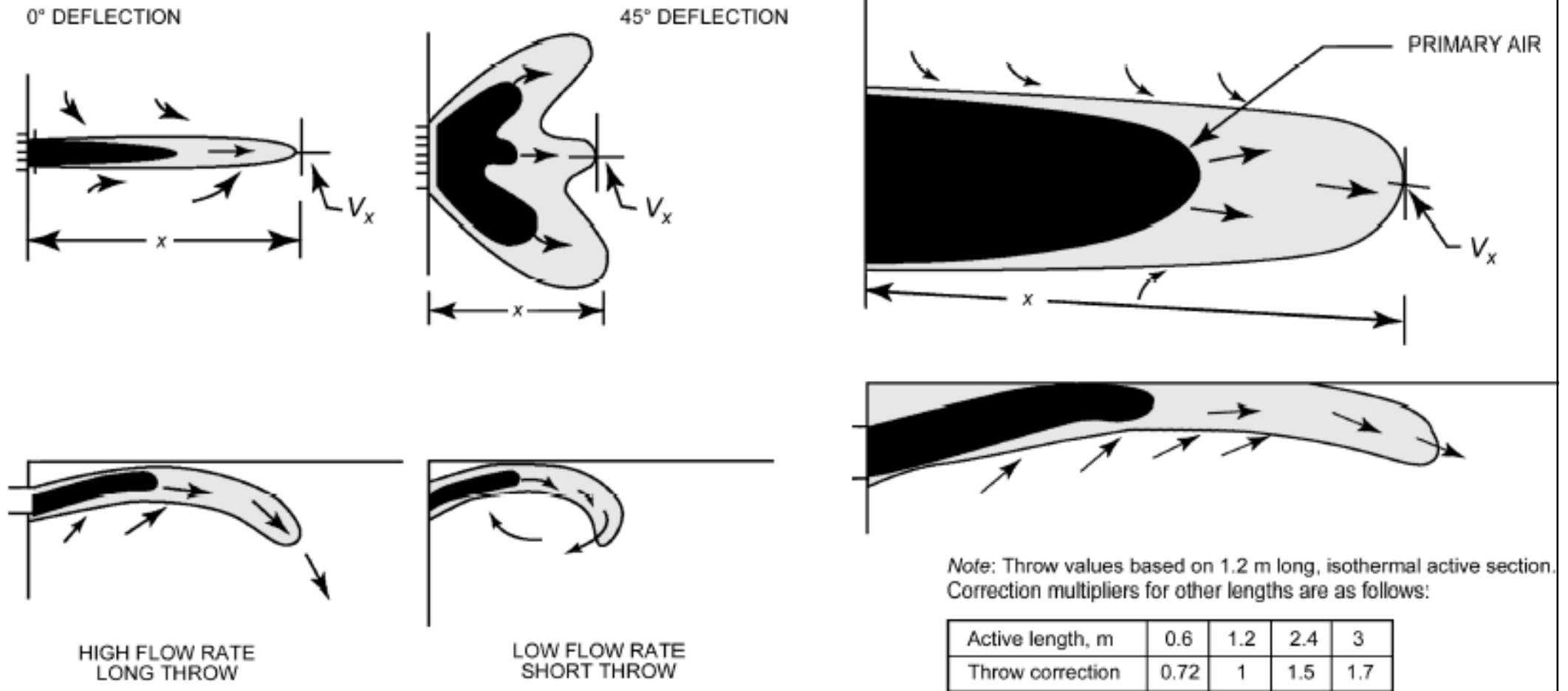

A. HIGH SIDEWALL GRILLES

B. HIGH SIDEWALL LINEAR



Outlets and Inlets

- Performance data of grilles and registers
 - Core size or core area
 - Volume flow rate
 - Air velocity
 - Total pressure loss
 - Throw at various terminal velocities
 - Noise criteria curve

Ceiling diffusers

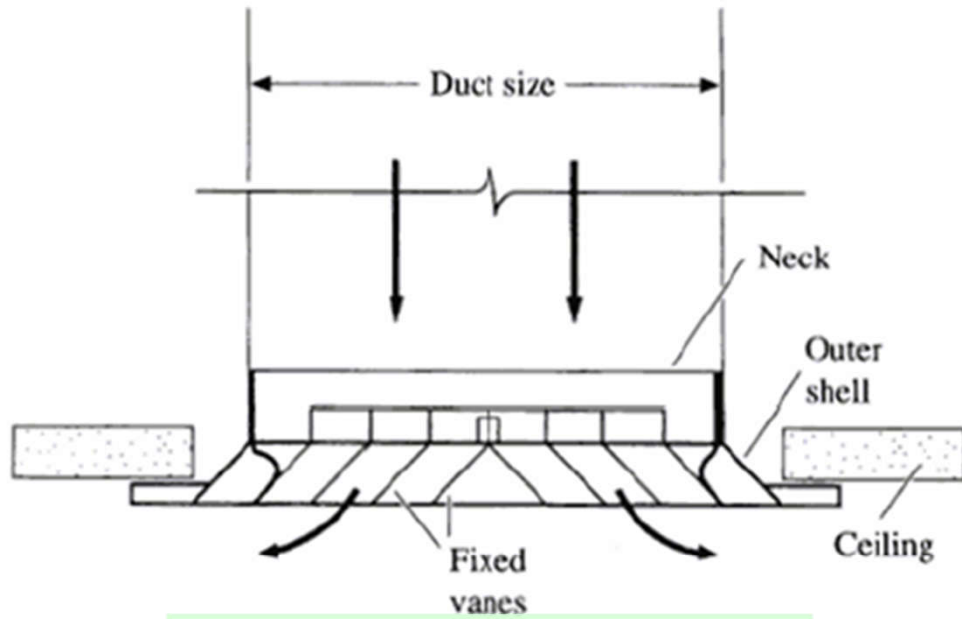

Square & rectangular

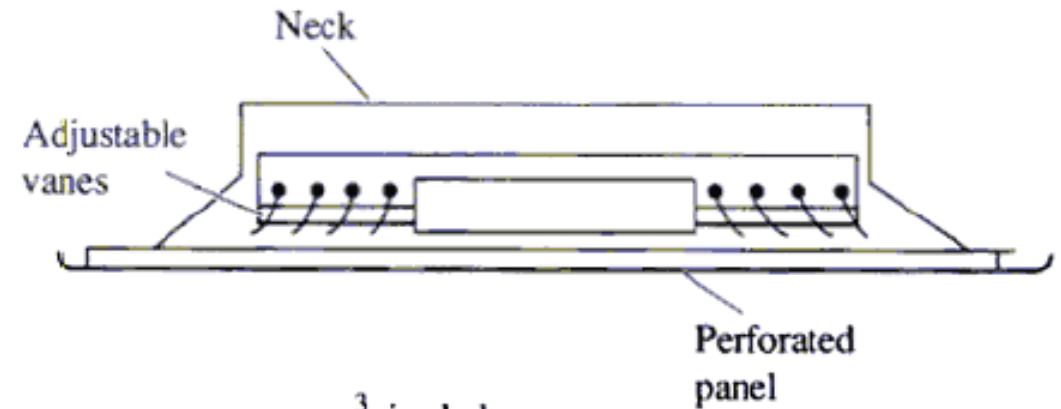

Removable inner-core

$\frac{3}{16}$ in. hole

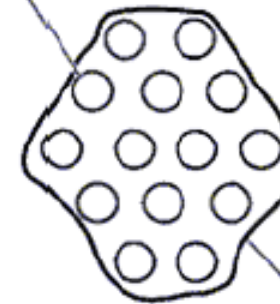

Perforated panel

Perforated ceiling diffuser

Slot diffusers

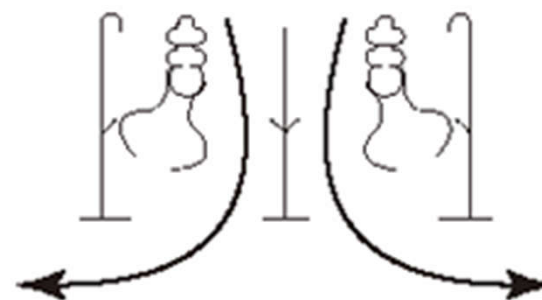
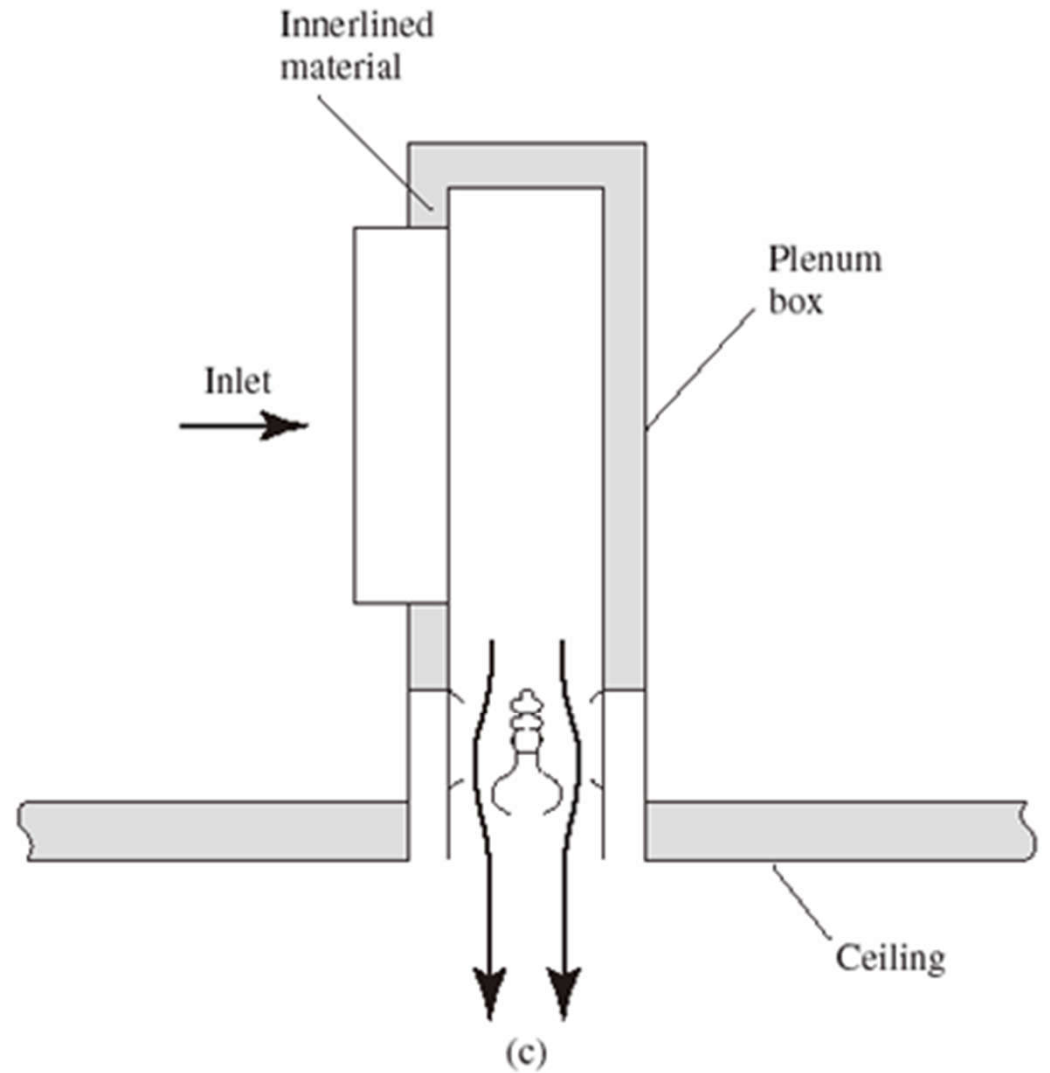
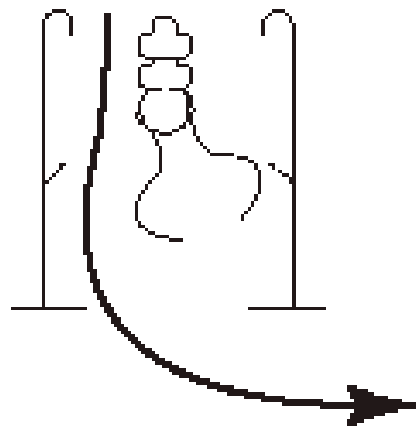
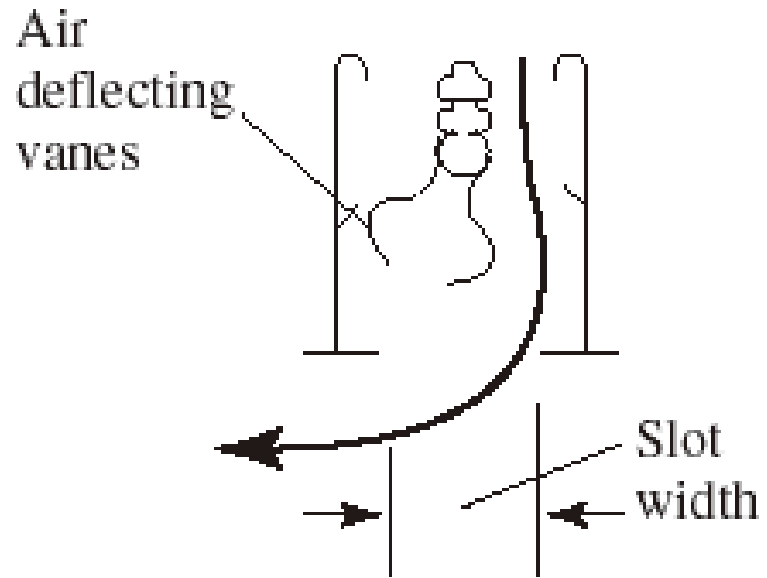

Nozzle diffusers

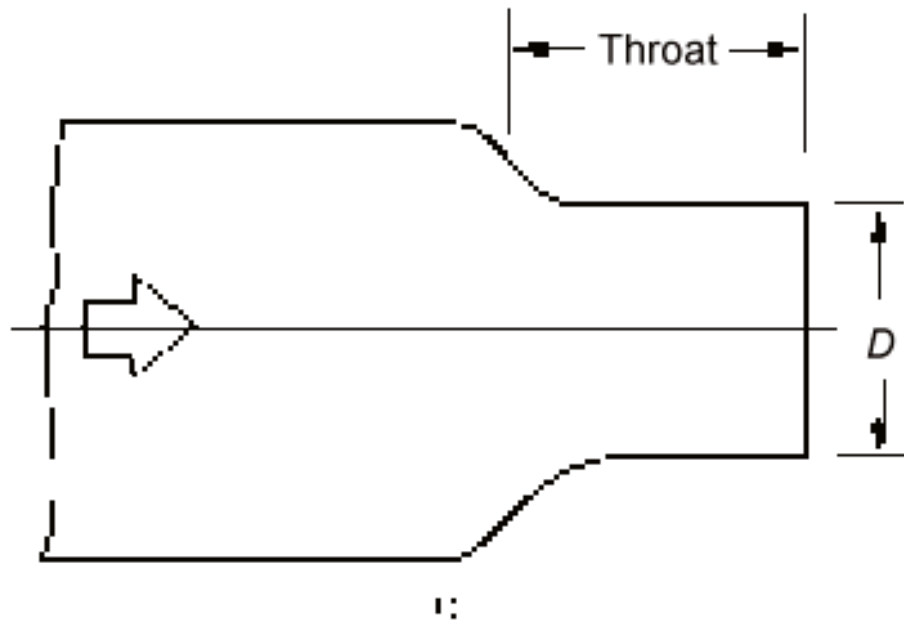

Round nozzle

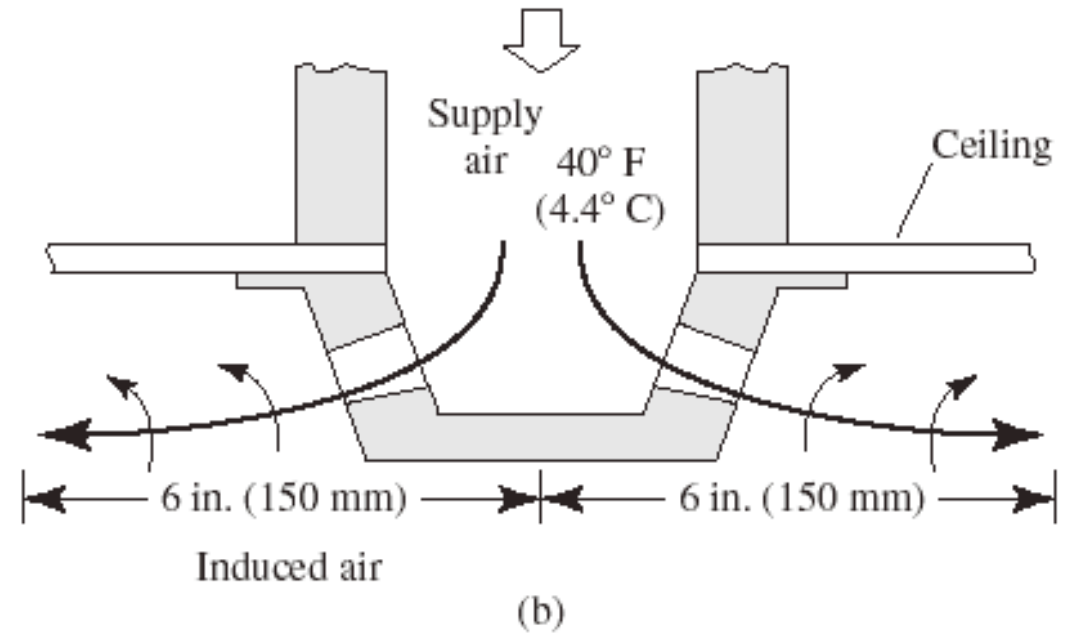

Nozzle diffuser

Accessories for supply outlets

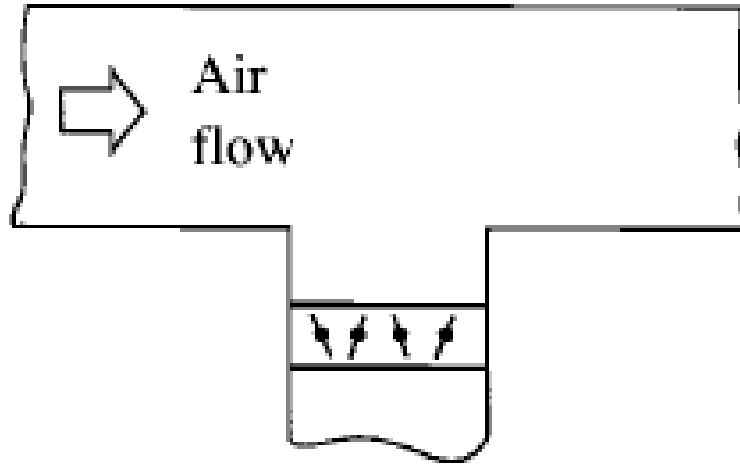

Outlet collar

(a)

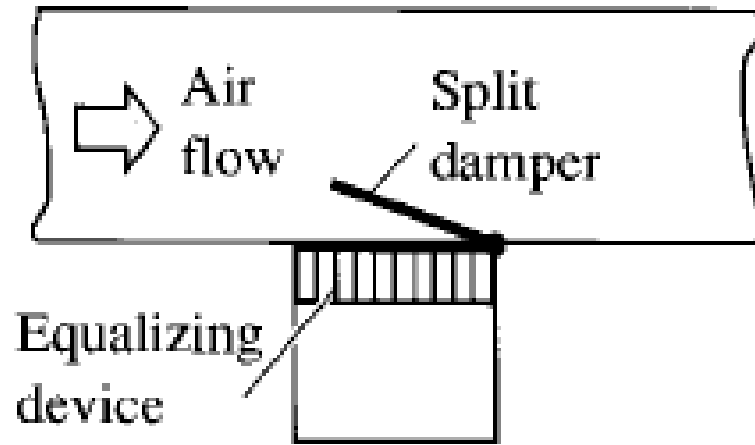

Outlet collar

(b)

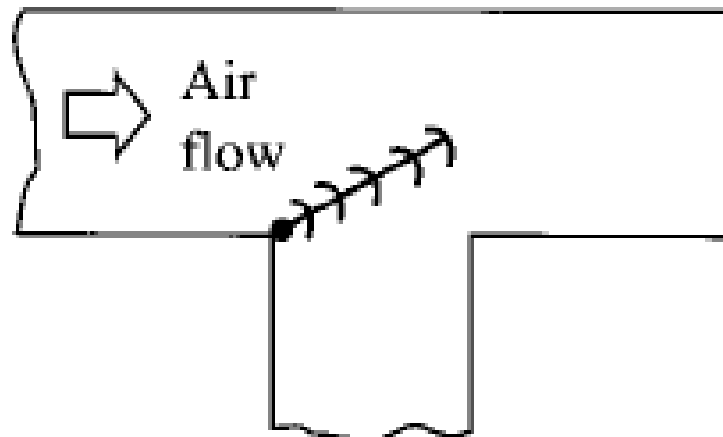

(c)

Return grilles and registers

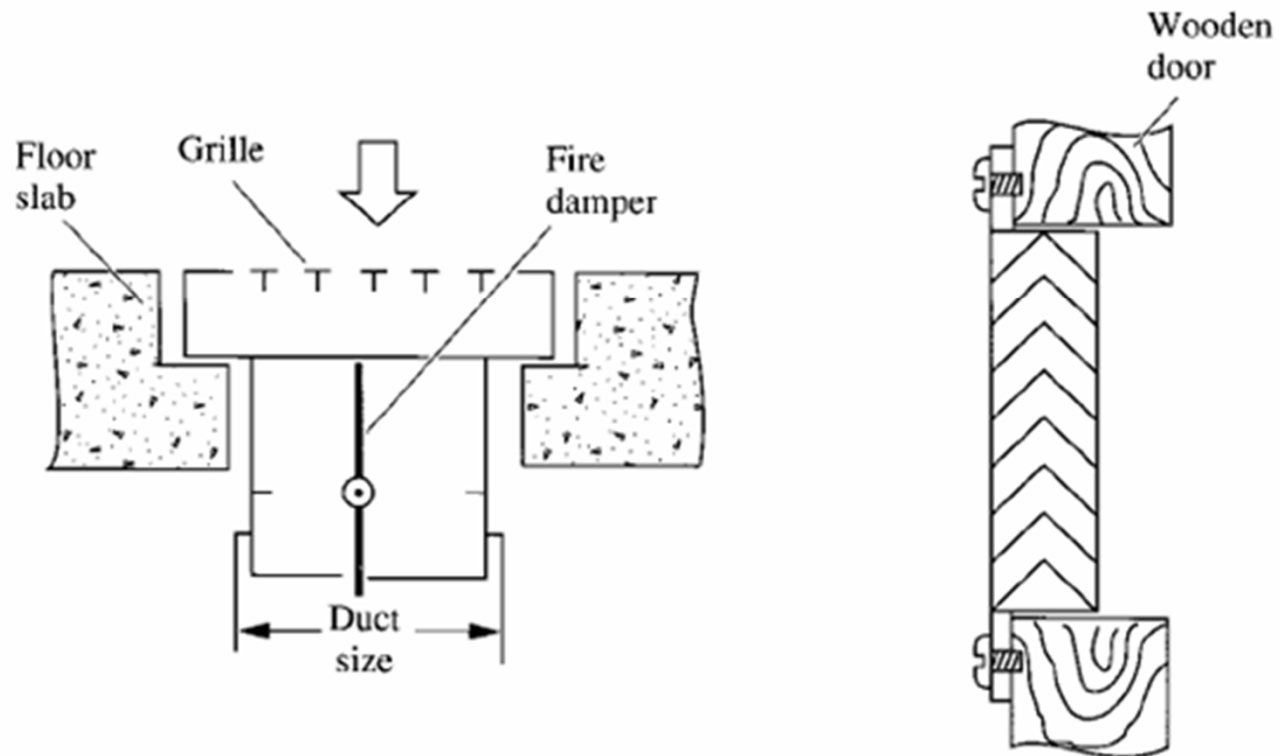
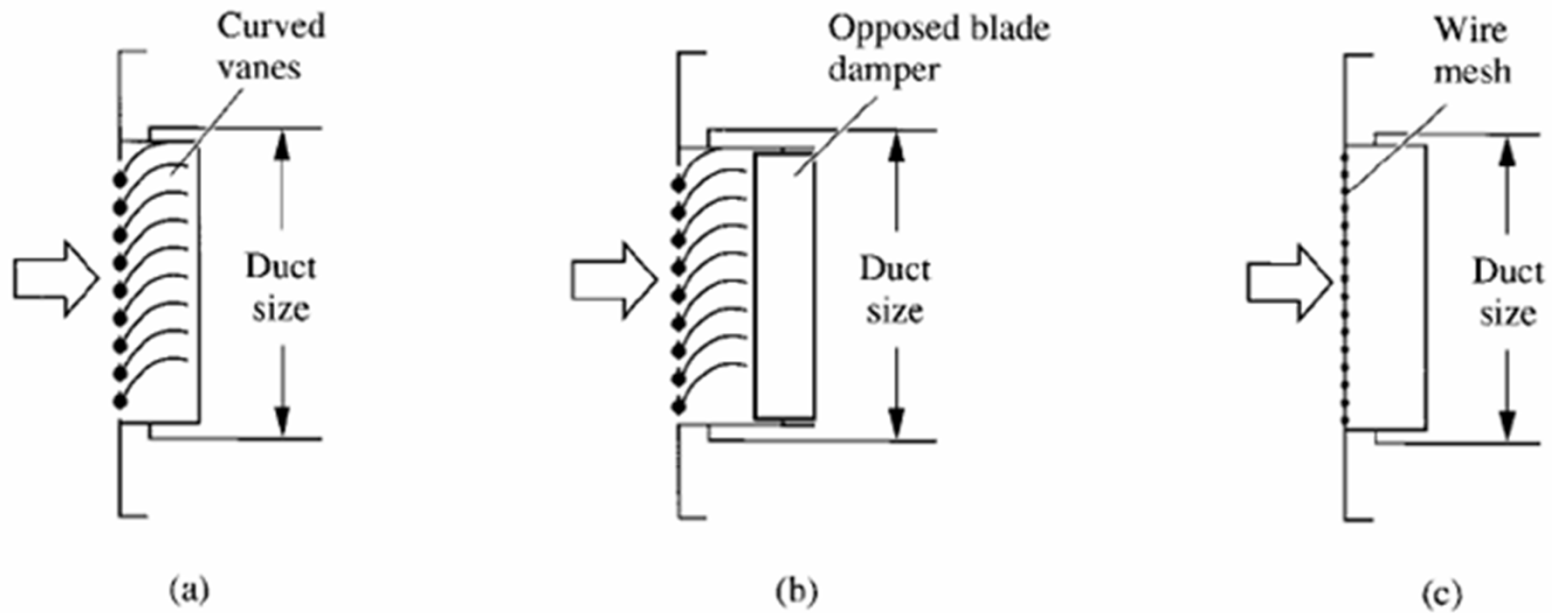

Return slots

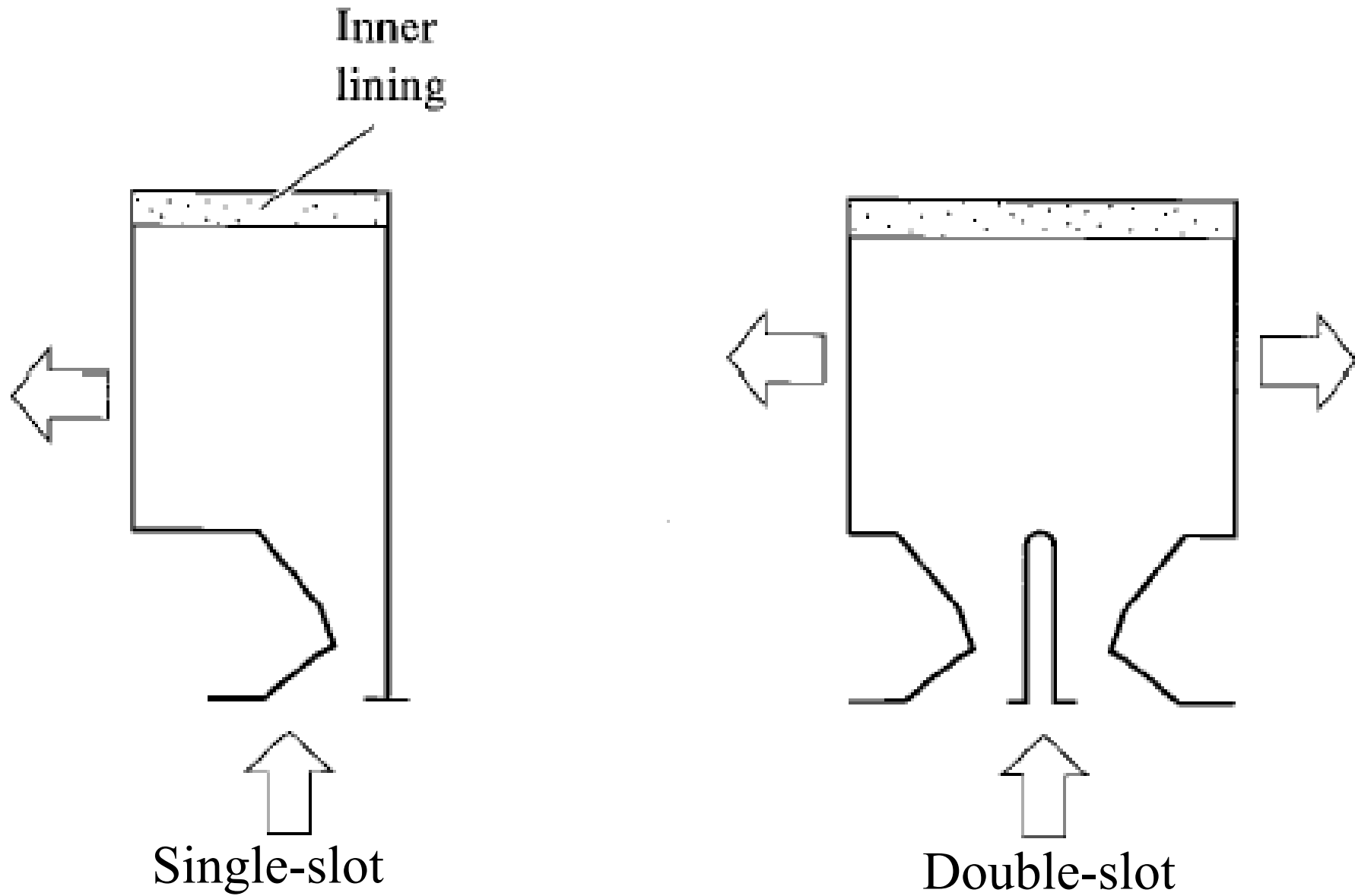

Light troffer, slot diffuser and return slot combination

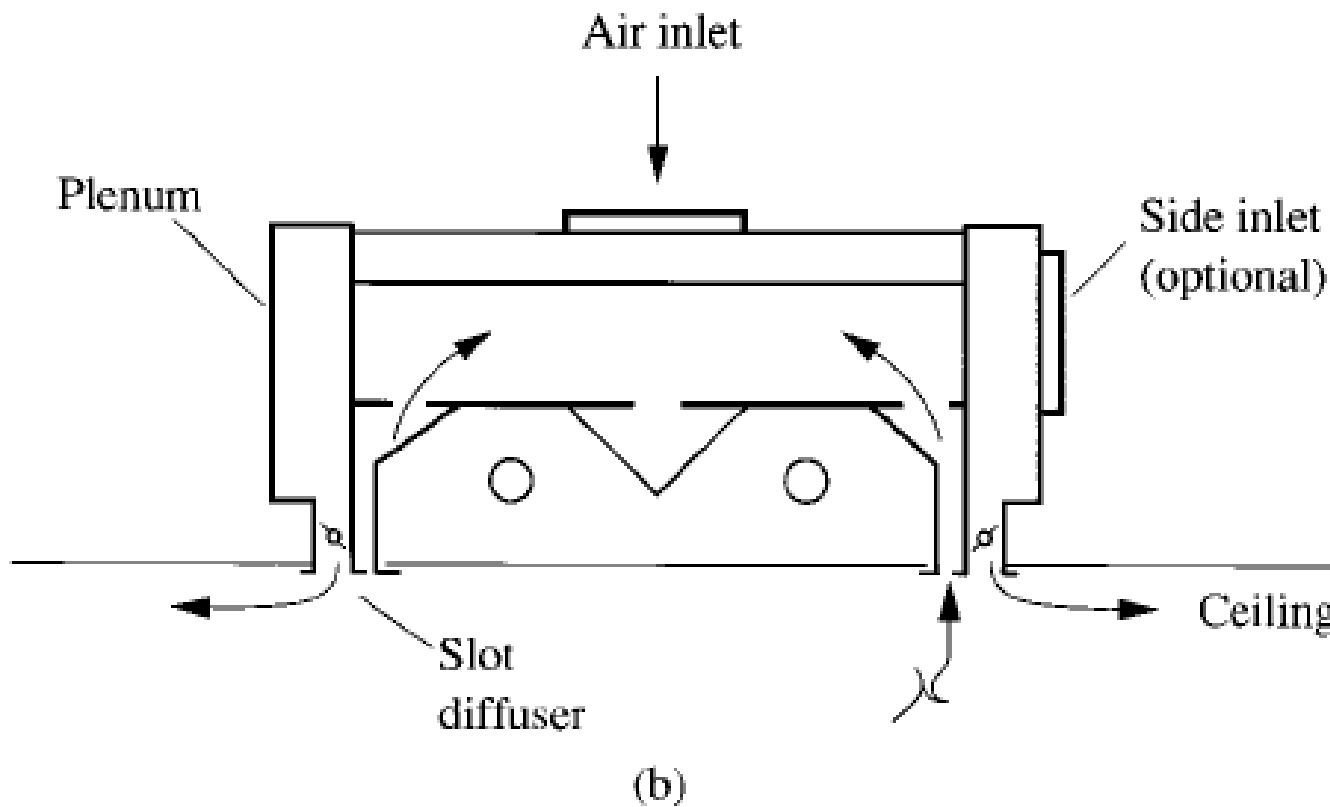
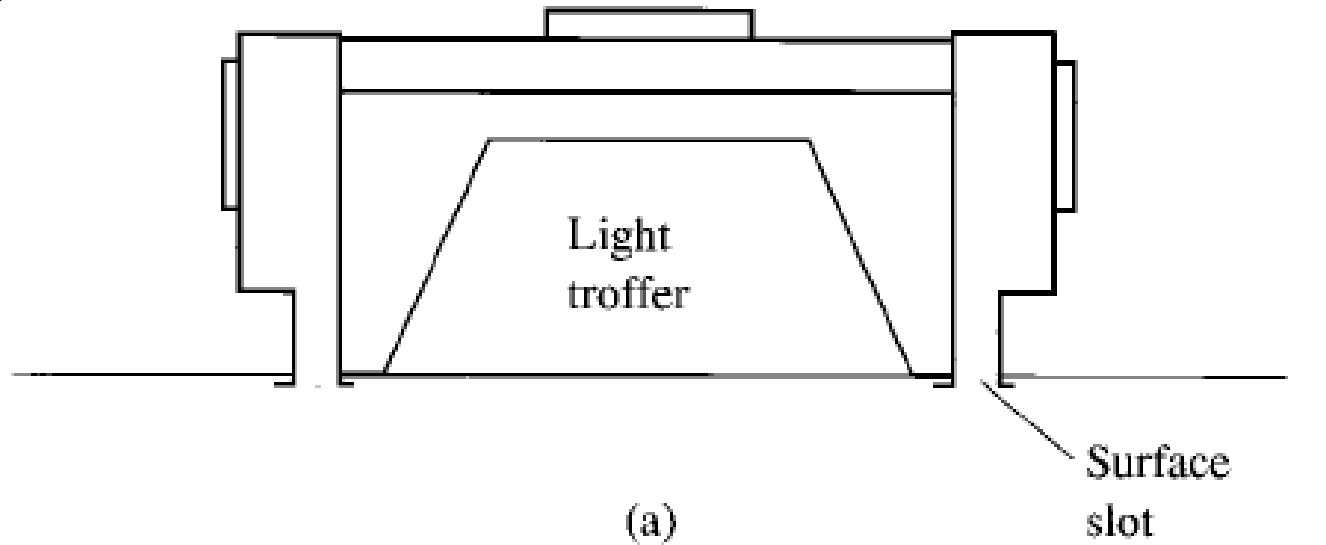

Mixing Flow

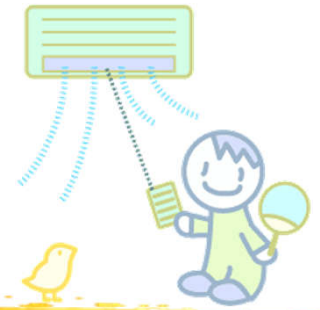

- Four typical airflow patterns
 - Mixing flow (most common)
 - Displacement flow
 - Projecting flow
 - Upward flow
- Also, task or personal air-conditioning systems
- Thermal stratification of air and mixing of air
 - Air distribution strategies

Classification of air distribution strategies

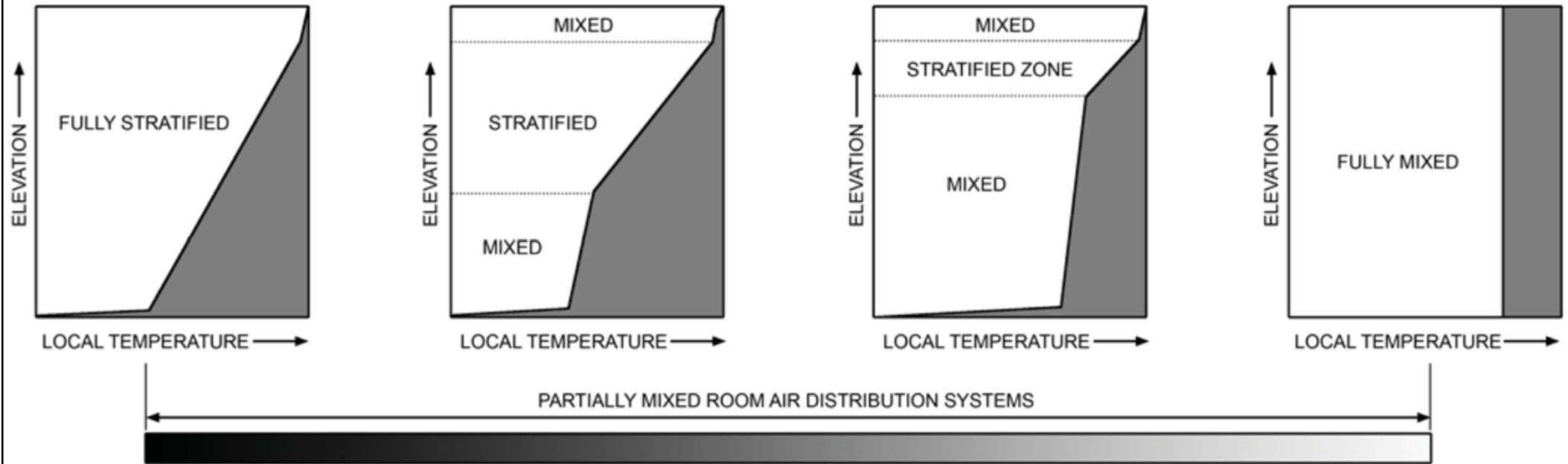

1. Fully mixed systems	Have little or no thermal stratification of air within the occupied and/or process space, e.g. overhead air distribution
2. Fully stratified systems	Have little or no mixing of air within the occupied and/or process space, e.g. Thermal displacement ventilation
3. Partially mixed systems	Provide some mixing of air in the occupied and/or process space while creating stratified conditions in the volume above, e.g. most underfloor air distribution designs
4. Task/ambient air distribution	Focuses on conditioning only a portion of the space for thermal comfort and/or process control, e.g. task/ambient systems are personally controlled desk outlets and spot-conditioning systems

Mixing Flow

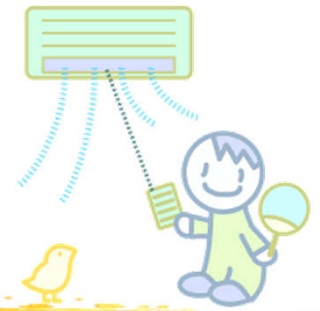

- Principles of mixing flow systems
 - Conditioned air discharged from outlets at high velocity
 - Conditioned air temperature may be above, below or equal to room air, depending on cooling/heating
 - Supply air mixed with room air by entrainment
 - Occupied zone is dominated by induced recirculating flow
 - Creates relatively uniform air velocity, temperature, humidity, and air quality

Space air diffusion with overhead cooling and heating

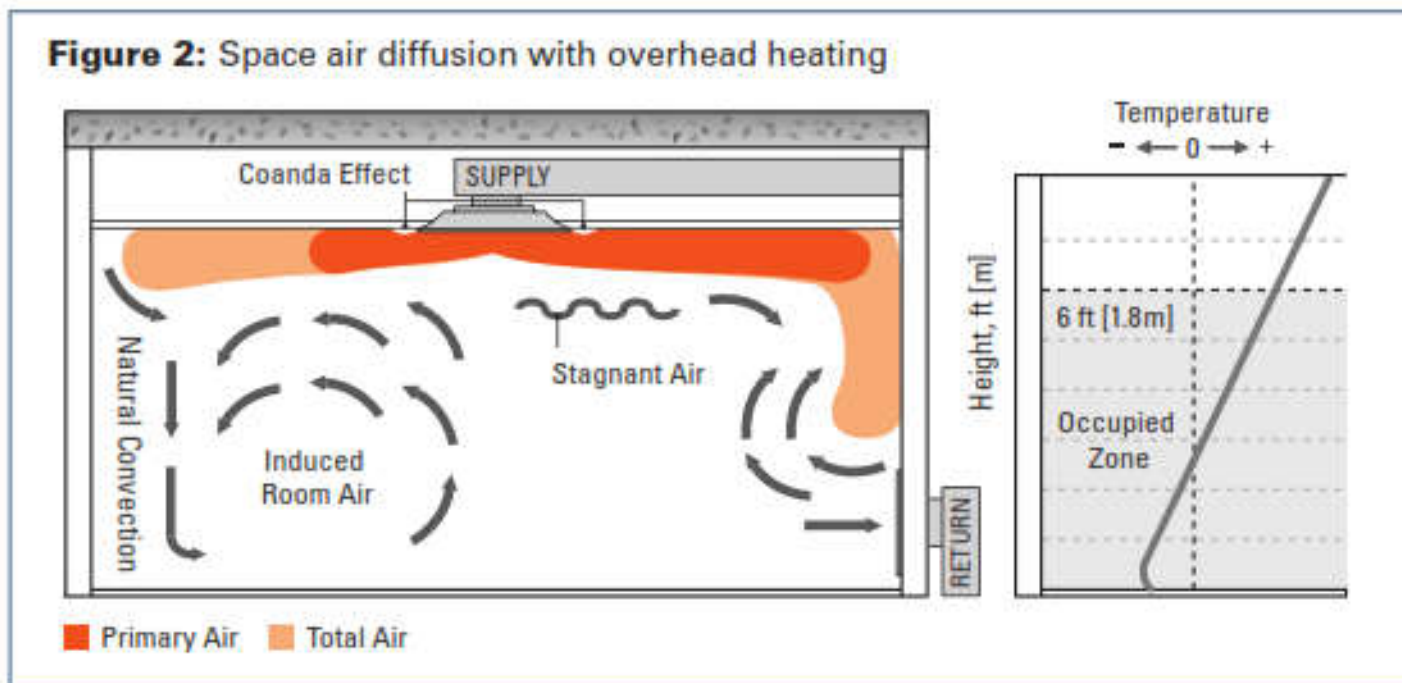
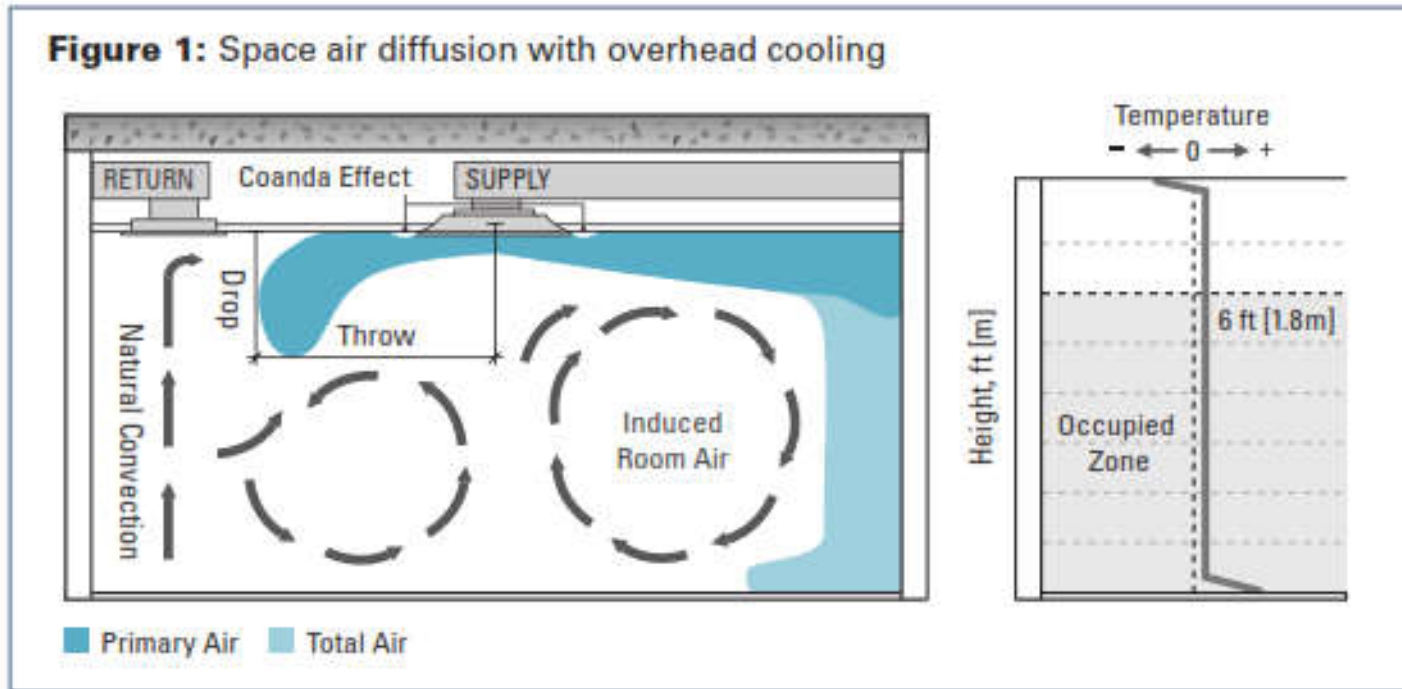

Mixing Flow

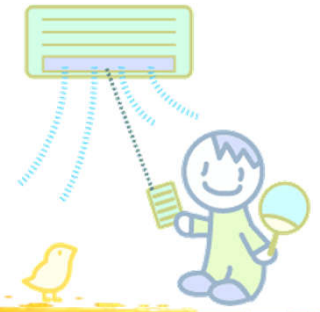

- Characteristics of mixing flow
 - Induction of space air into the air jet
 - Reverse airstream (induced) in occupied zone
 - Minimise the stagnant area in occupied zone
 - Air velocity of stagnant area < 0.1 m/s
 - Types & locations of return & exhaust inlets
 - Does not significantly affect airflow pattern
 - Does affect the thermal effectiveness factor ε_T

Mixing Flow

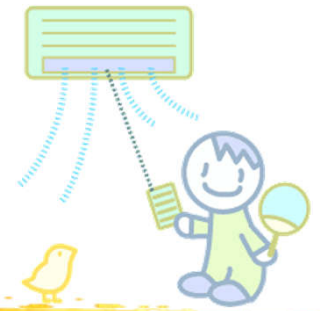

- Outlet classification (from ASHRAE)
 - Group A. mounted in or near ceiling that discharge air horizontally
 - Group B. mounted in or near floor that discharge air vertically in a non-spreading jet
 - Group C. mounted in or near floor that discharge air vertically in a spreading jet
 - Group D. mounted in or near floor that discharge air horizontally
 - Group E. mounted in or near ceiling that project primary air vertically

Group A Outlets

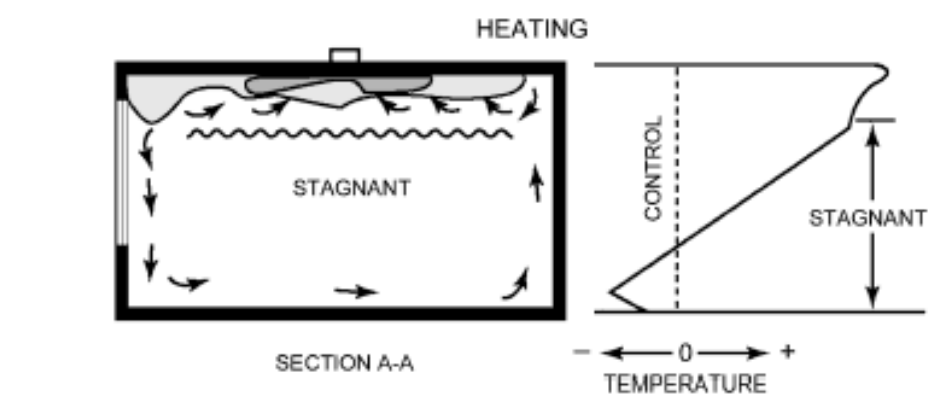
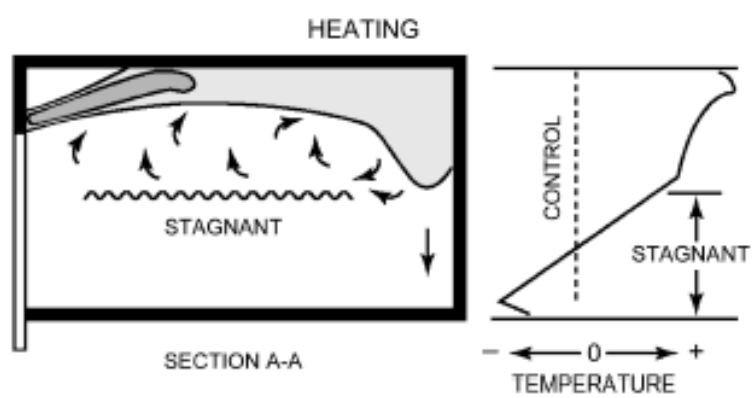
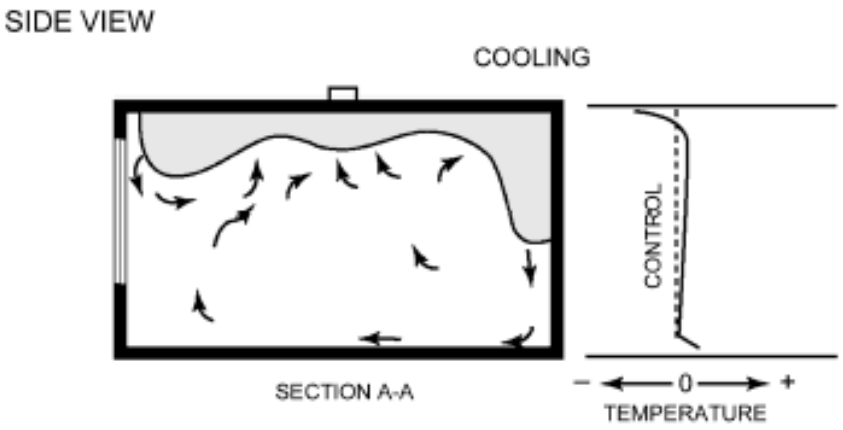
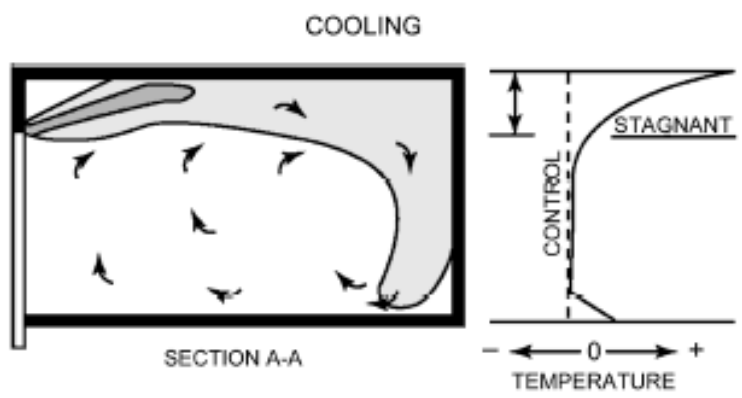
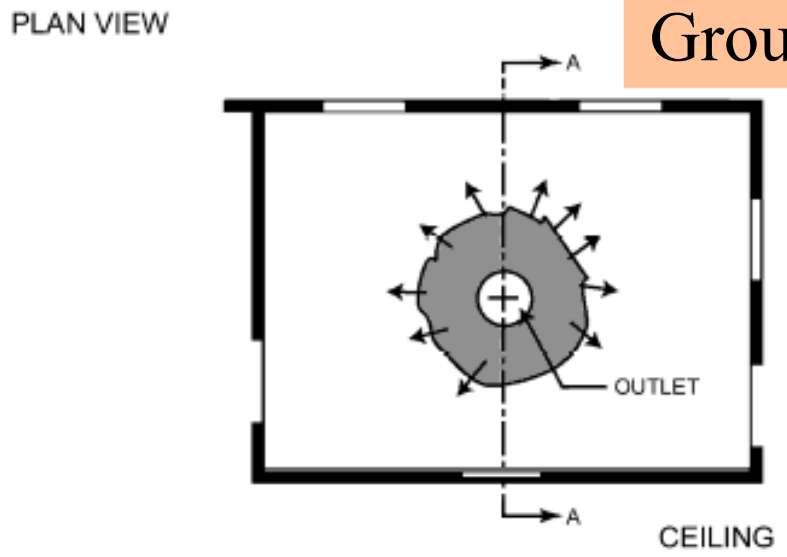
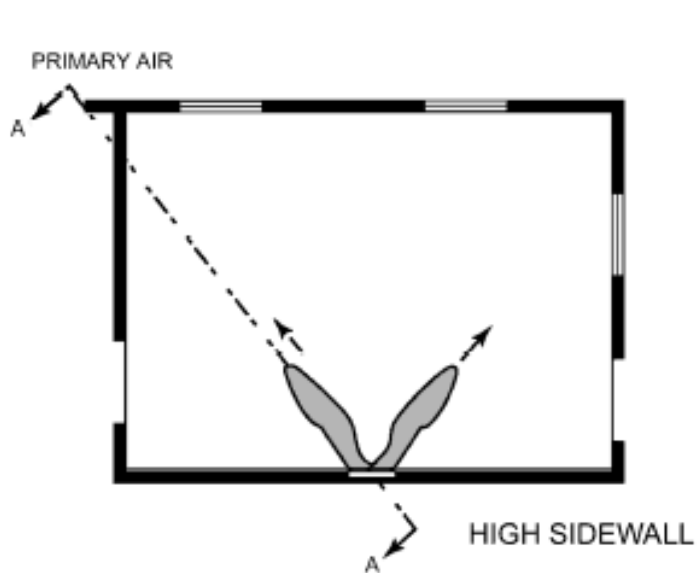

(Source: ASHRAE Handbook Fundamentals 2001)

Group B Outlets

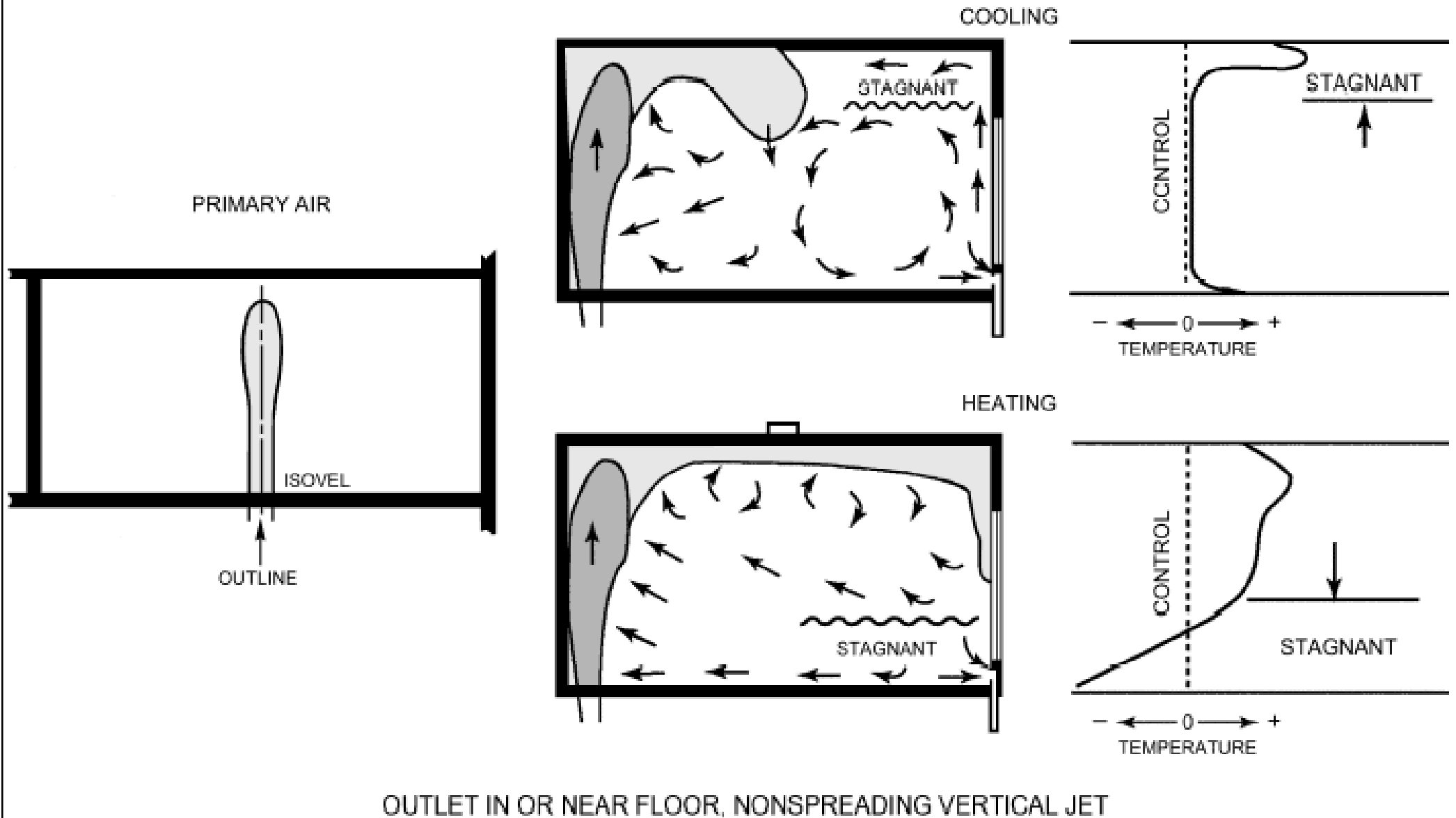

Group C Outlets

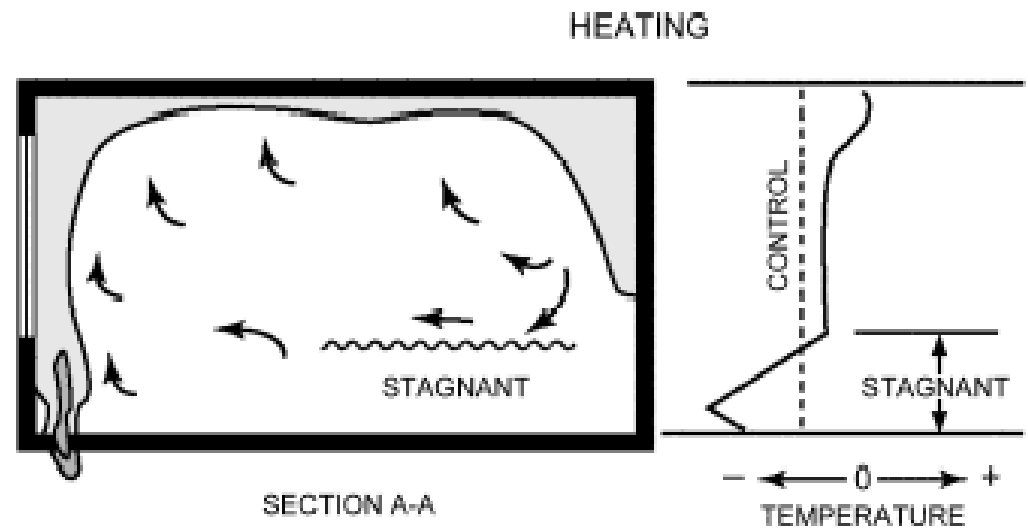
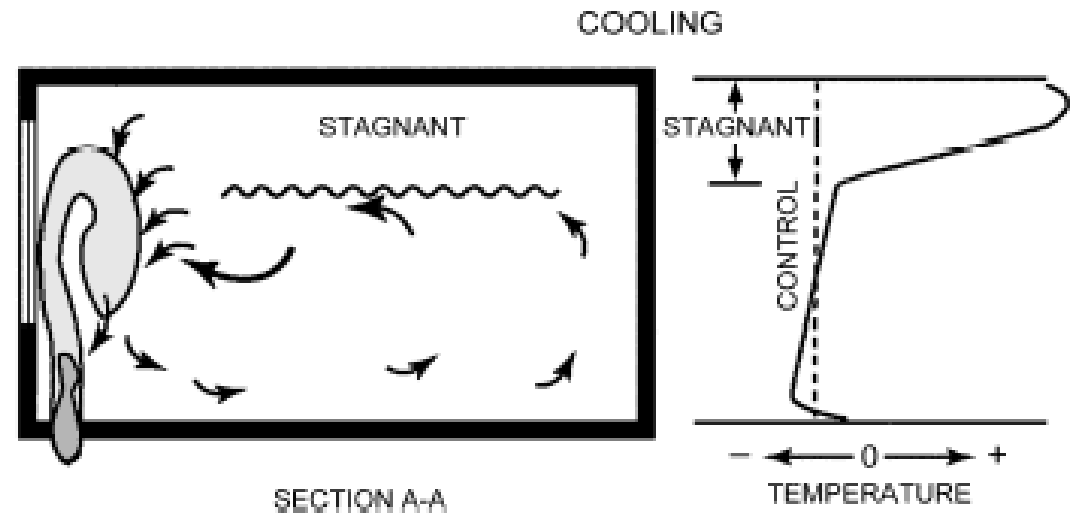
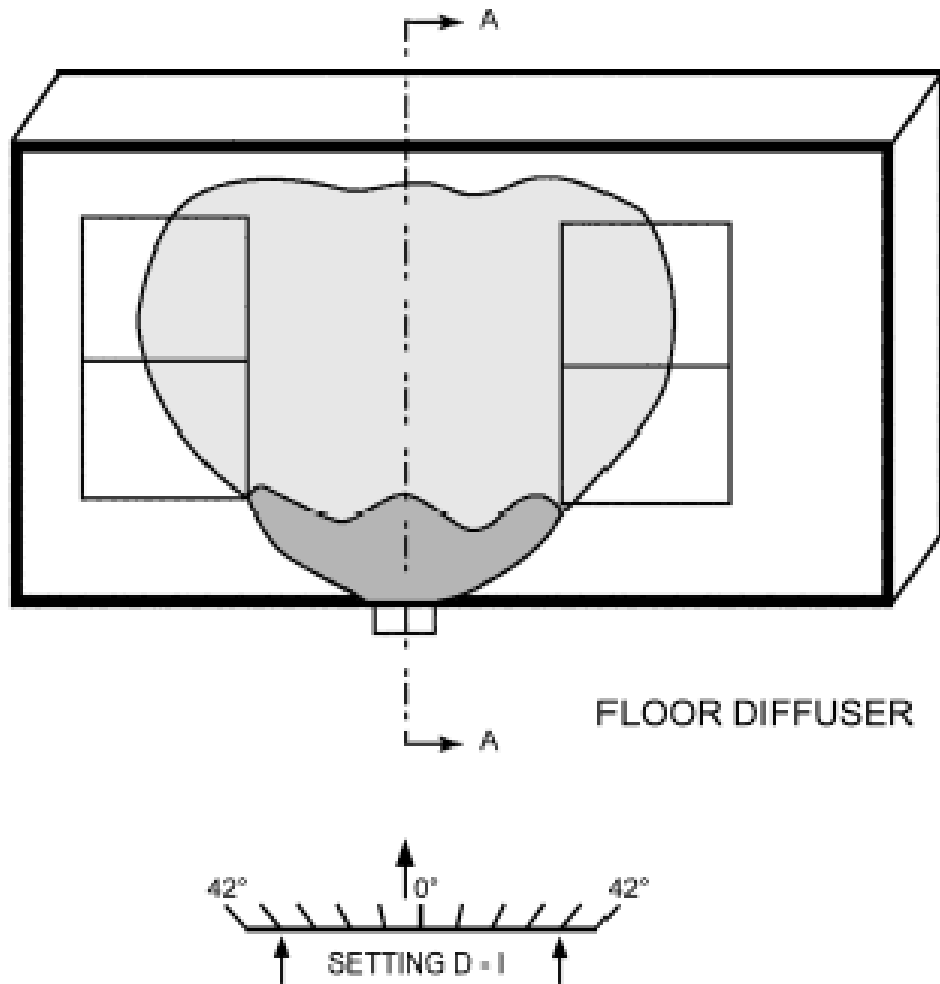

Group D Outlets

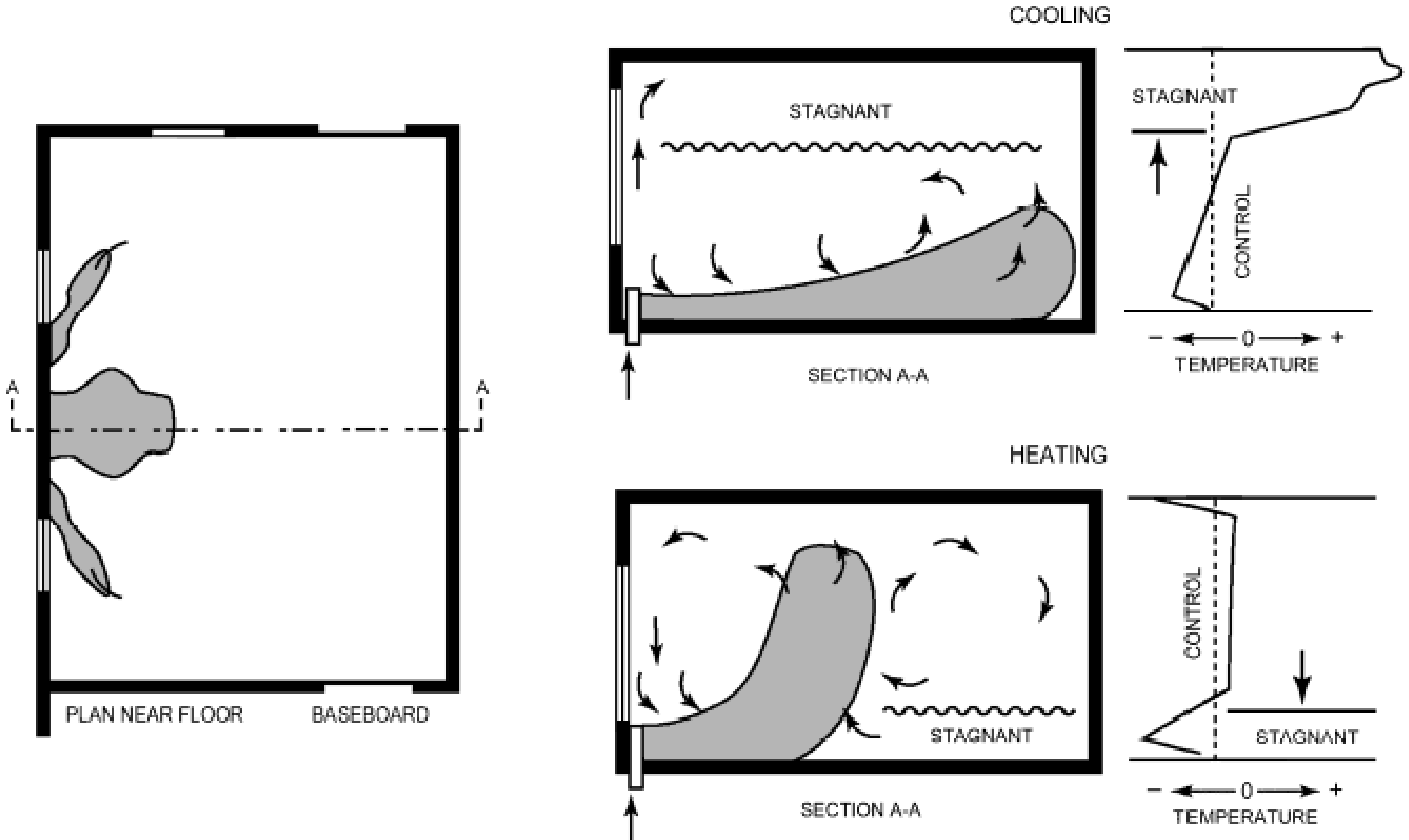

Group E Outlets

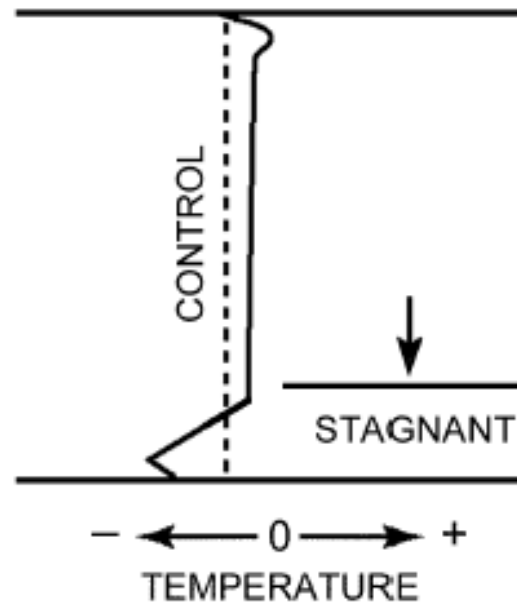
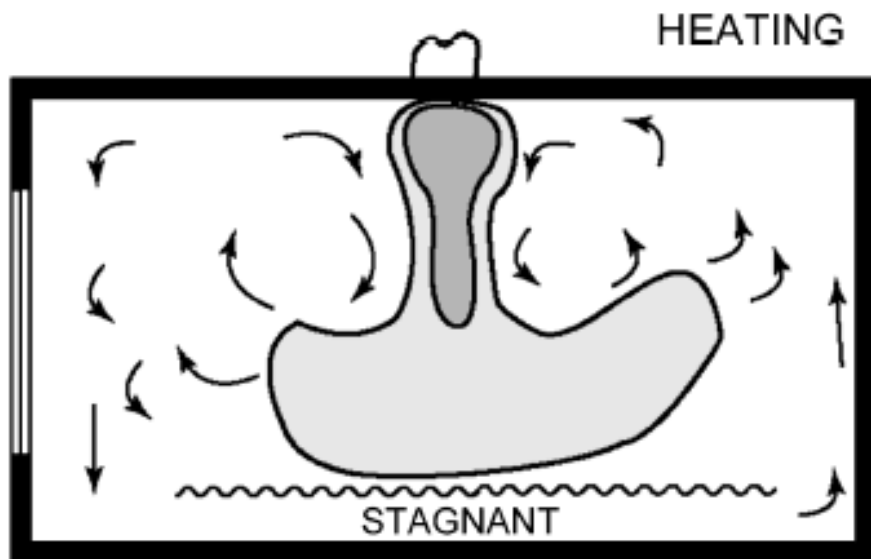
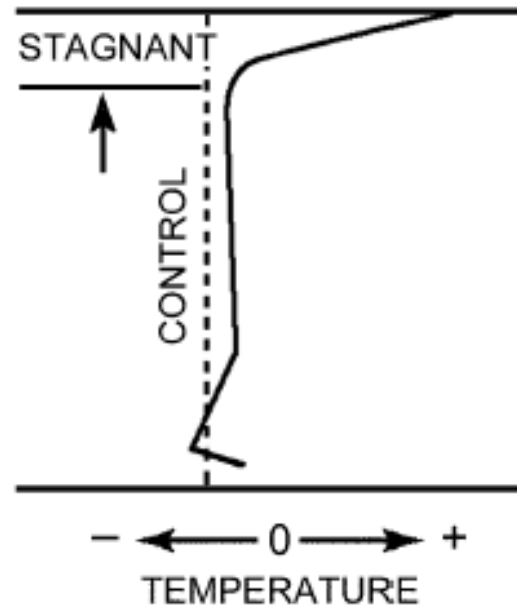
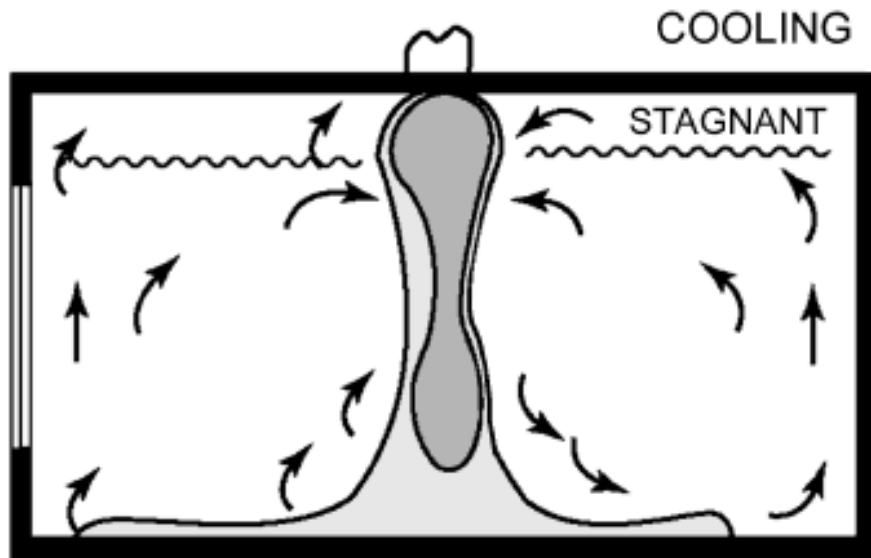

Mixing Flow

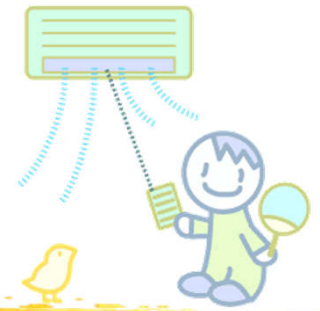

- Common types & locations of outlets
 - High side outlets
 - Ceiling diffusers
 - Slot diffusers
 - Sill and floor outlets
 - Outlets from stratified mixing flow
- Key questions
 - Will the air jet enter the occupied zone?
 - Will stagnant zone be formed?

Mixing flow using high side outlets

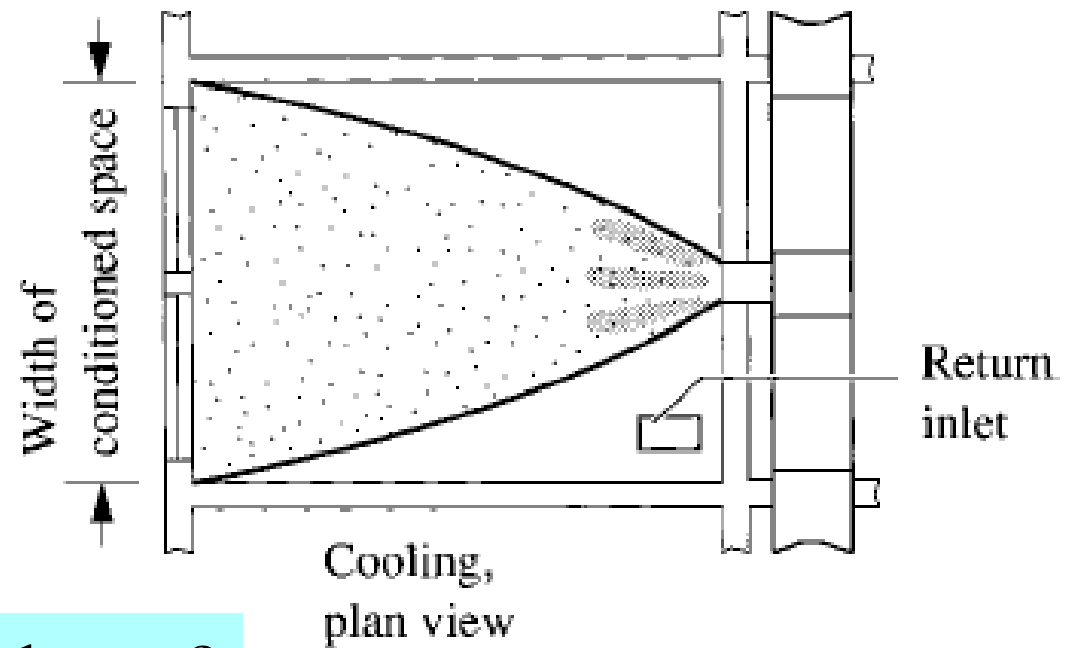
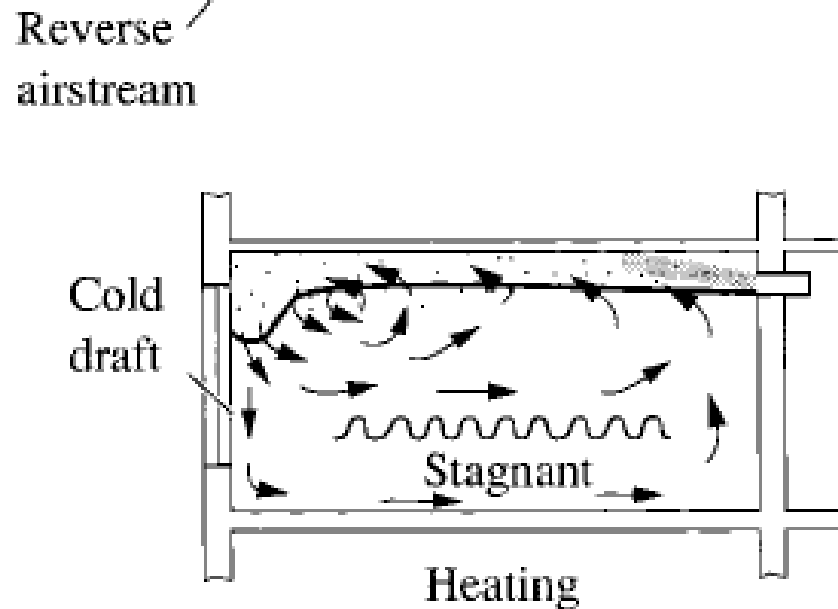
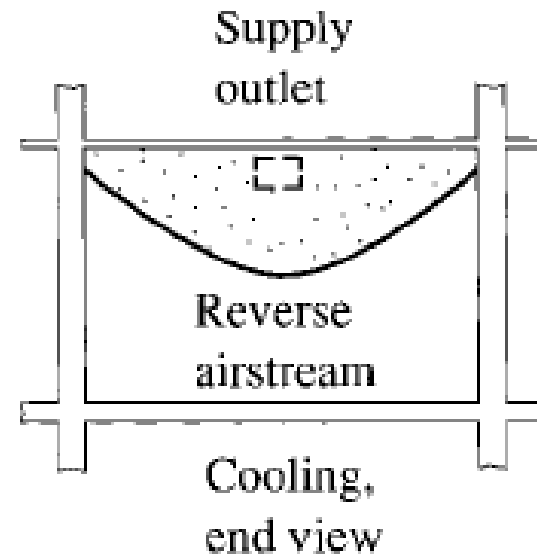
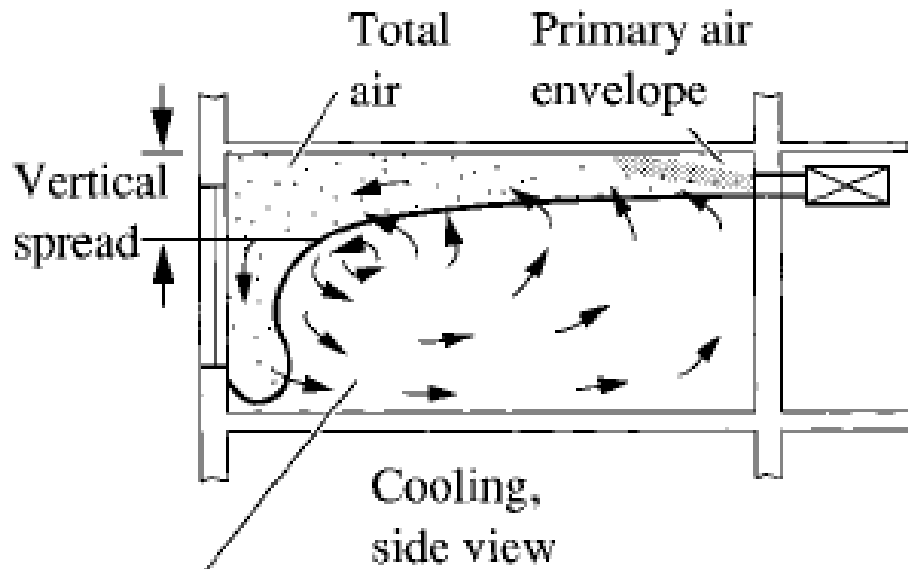

Will the air jet enter the occupied zone?
Will stagnant zone be formed?

Mixing flow using ceiling diffusers

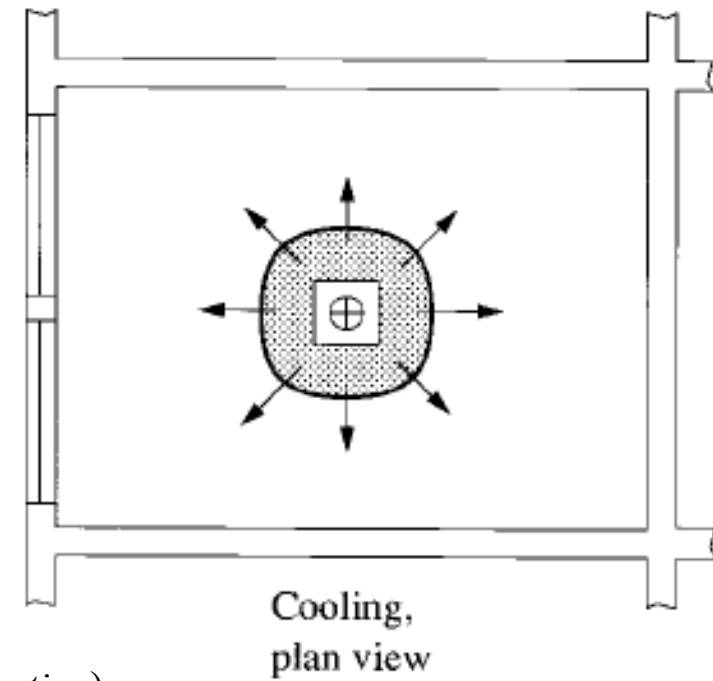
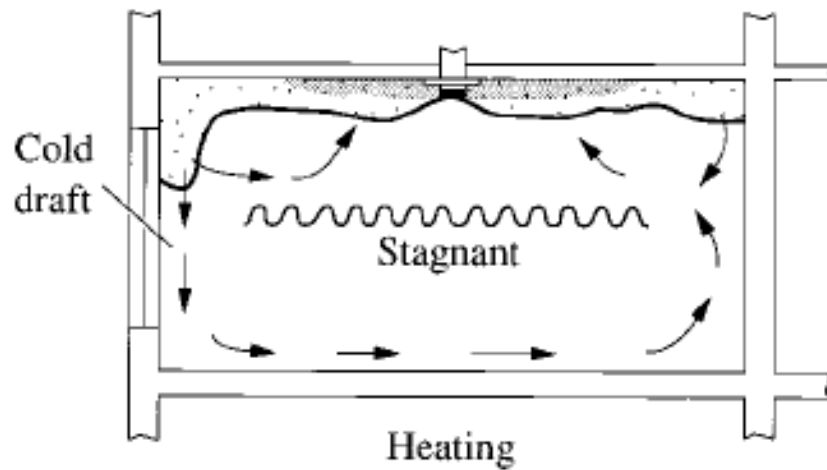
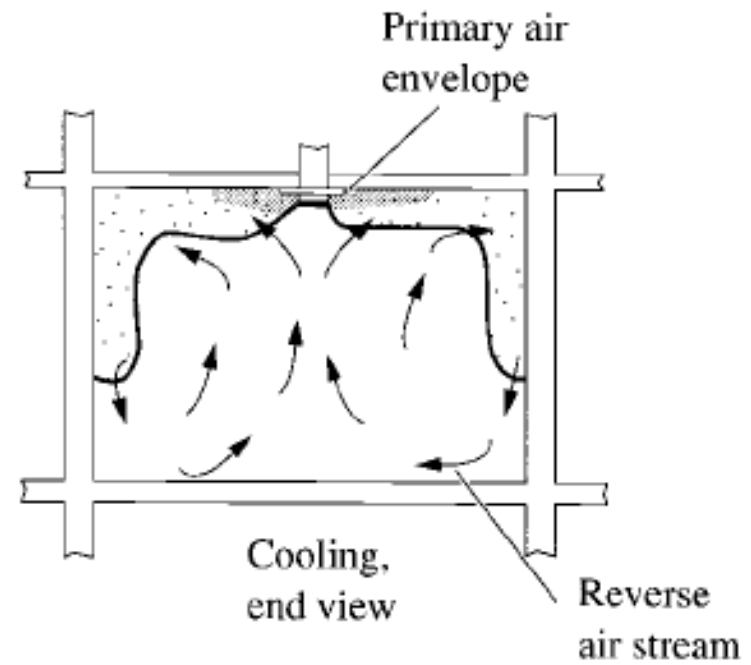
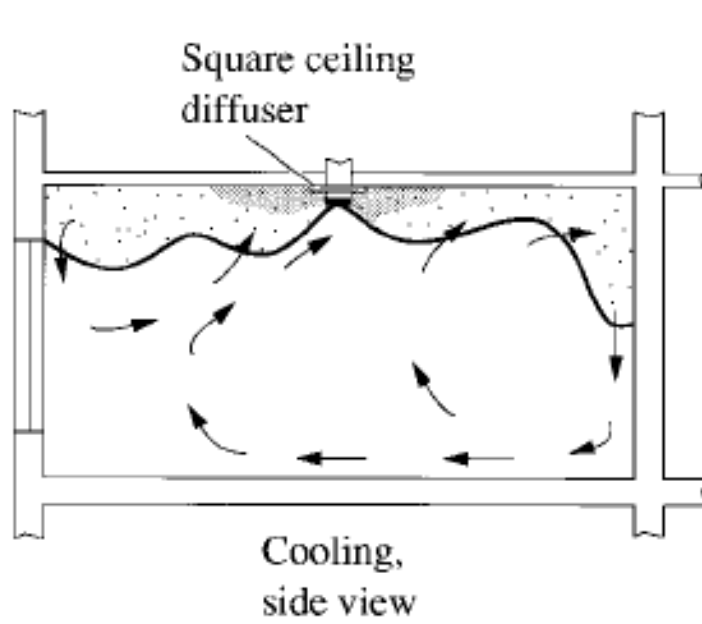

Mixing flow using slot diffusers

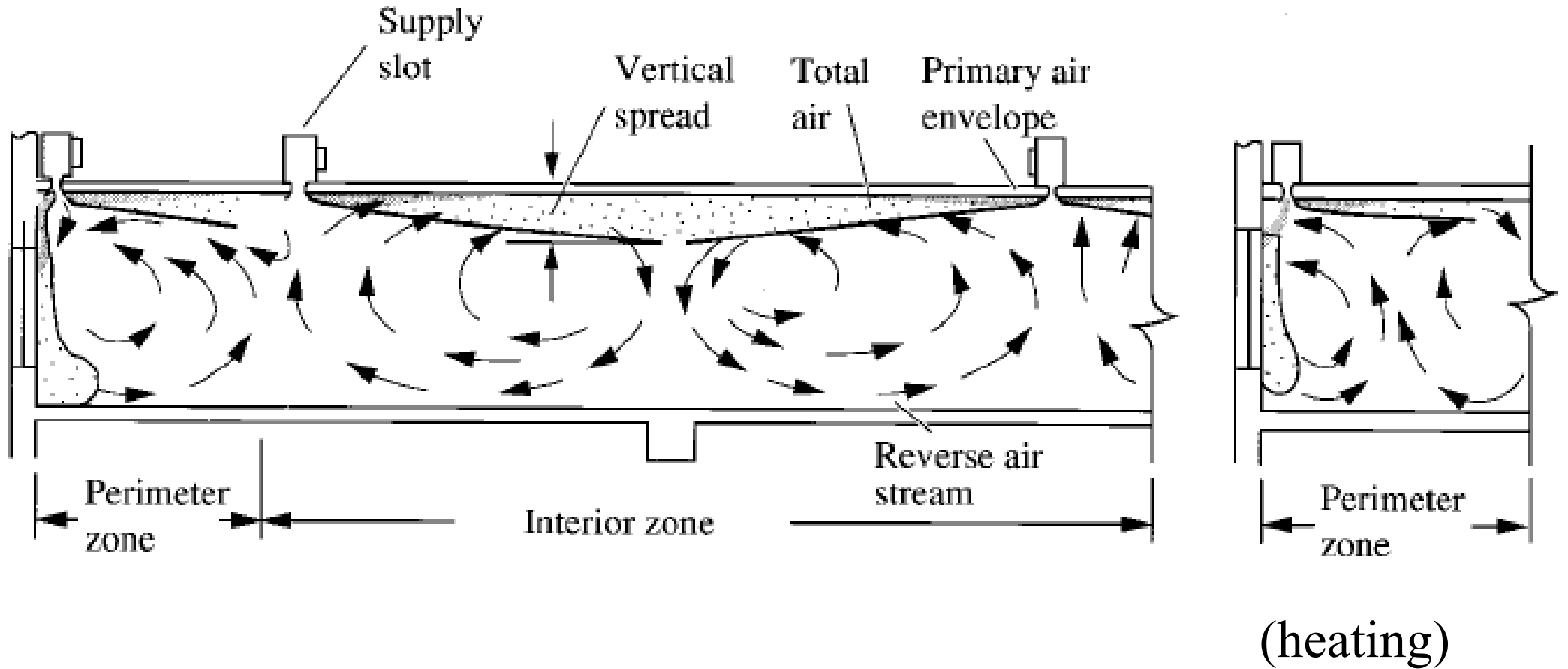

Mixing flow using sill outlet

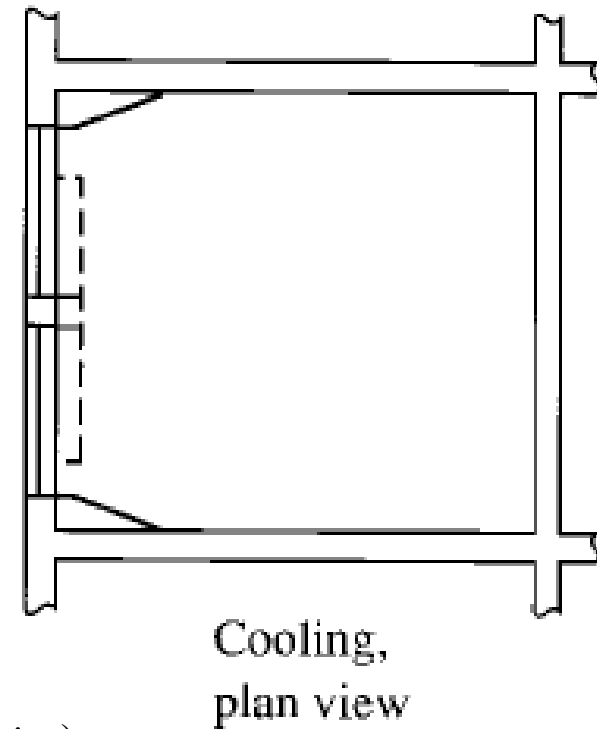
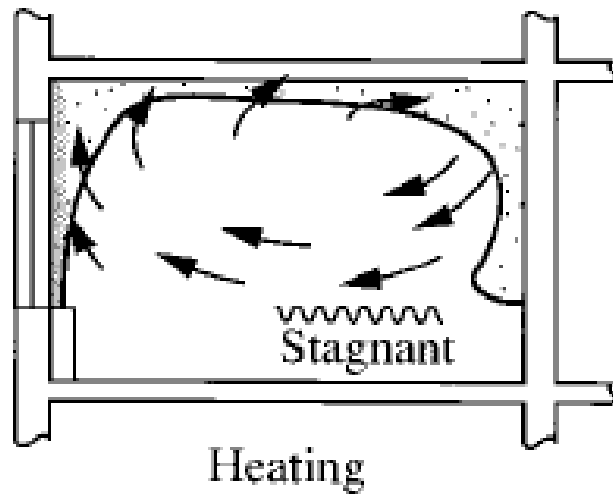
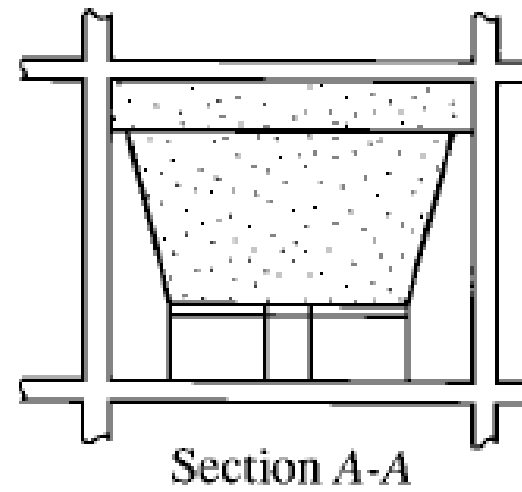
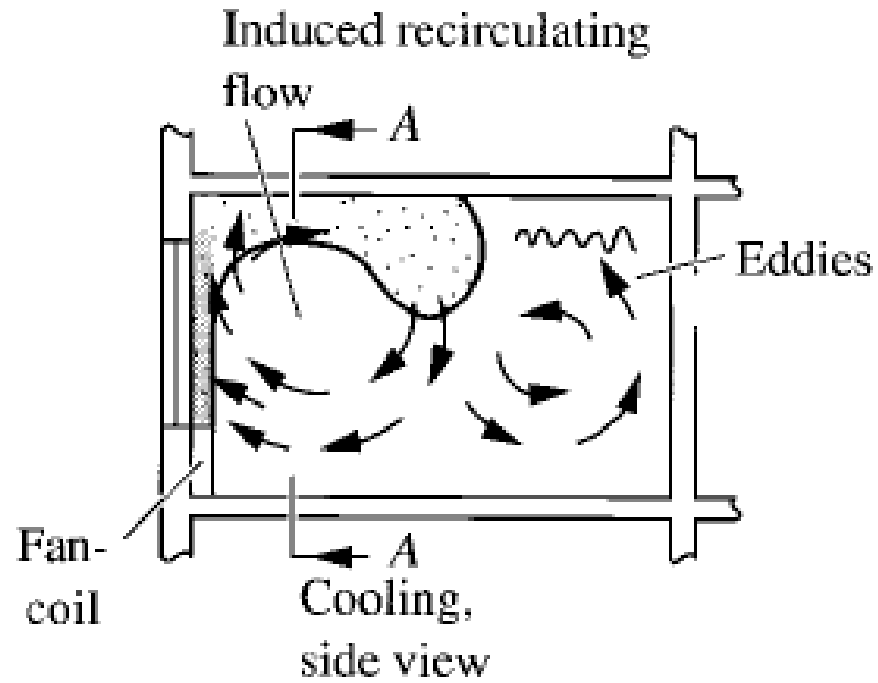

Space air diffusion with overhead cooling

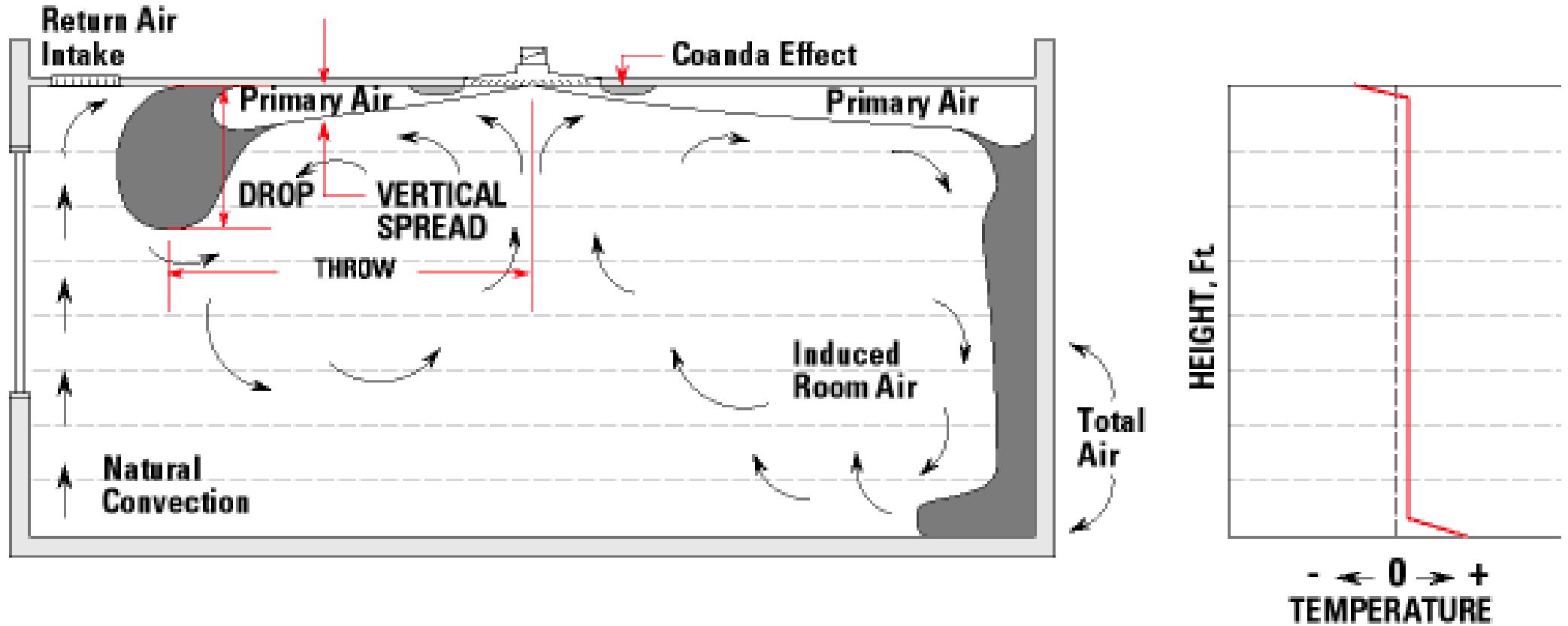

Space air diffusion with overhead heating

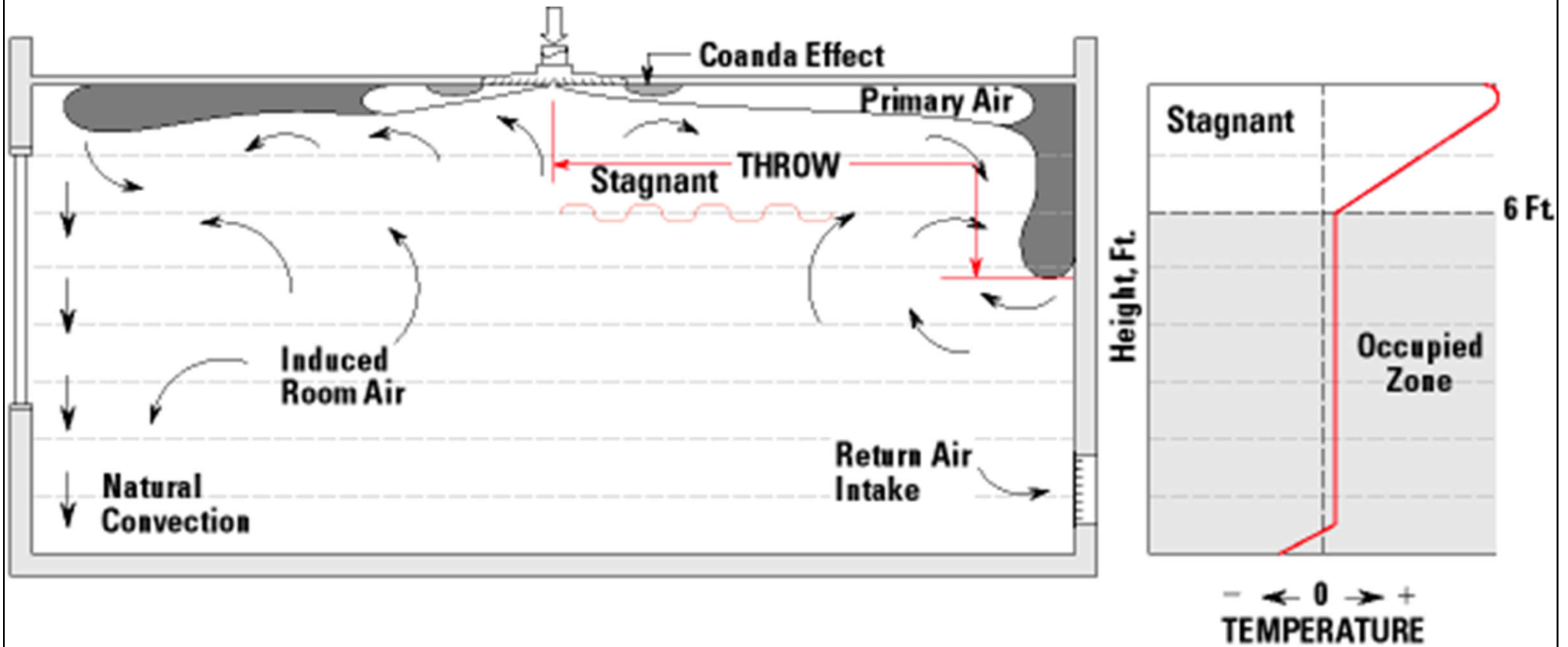

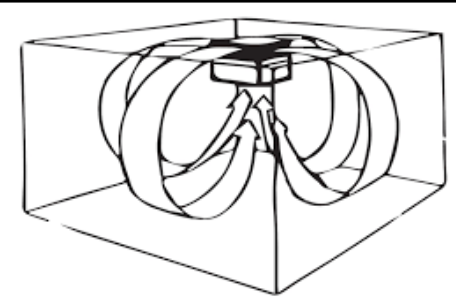

Design Issues

- In buildings with high ceiling (large spaces)
 - More economical to stratify the air vertically into zones during cooling
 - Upper boundary of the lower zone is at the level of the supply outlet where air jet projects horizontally
 - Examples:
 - Stratified mixing flow in a nuclear plant
 - Large, high-ceiling indoor stadium (w/ supply nozzles)
 - Chek Lap Kok Airport
 - Assembly halls

Stratified mixing flow in a nuclear facility

During cooling

During heating

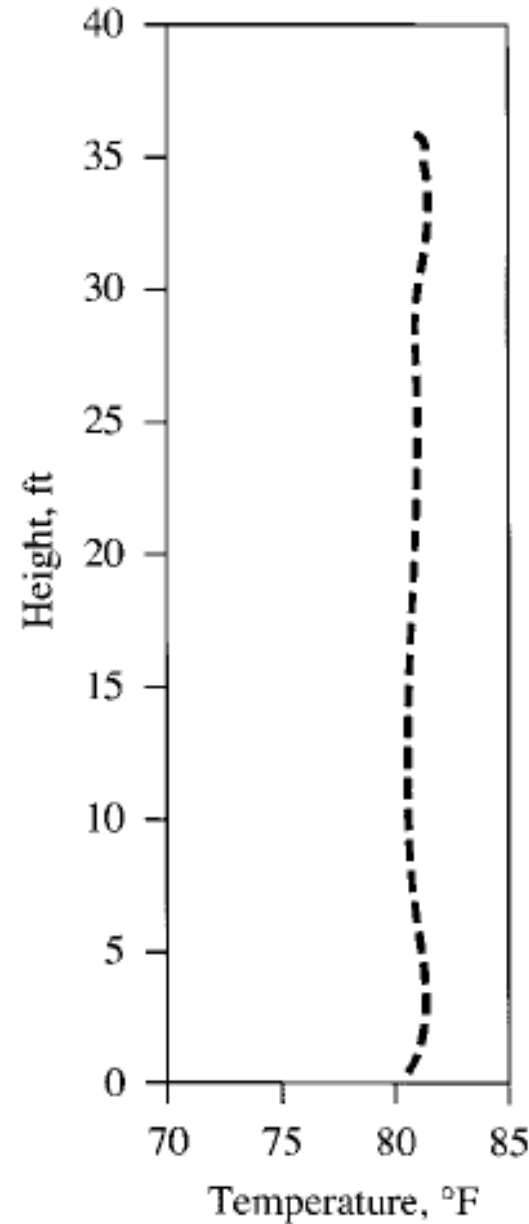
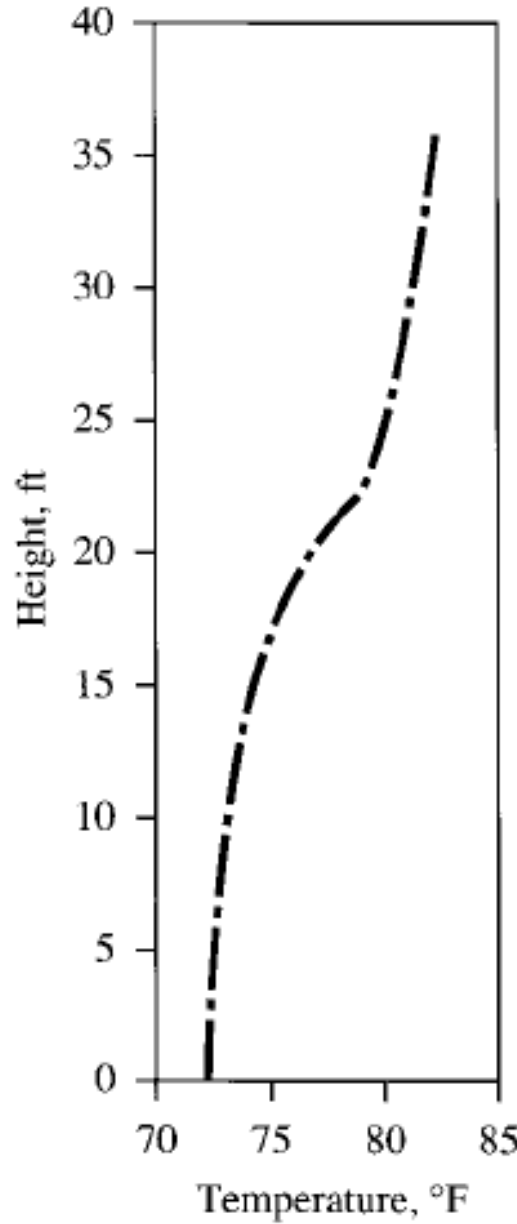
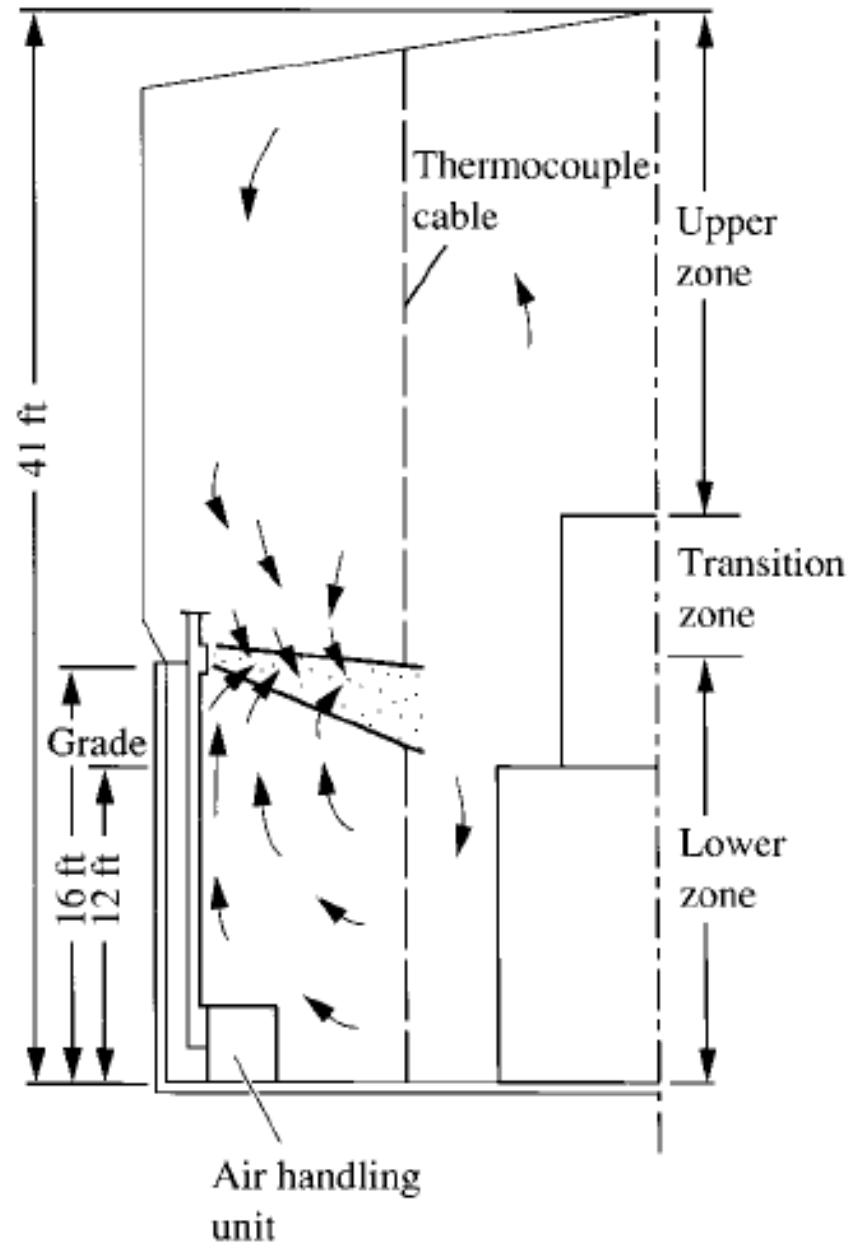

(Source: Wang, S. K., 2001. Handbook of Air Conditioning and Refrigeration)

Stratified mixing flow in a large indoor stadium using supply nozzles

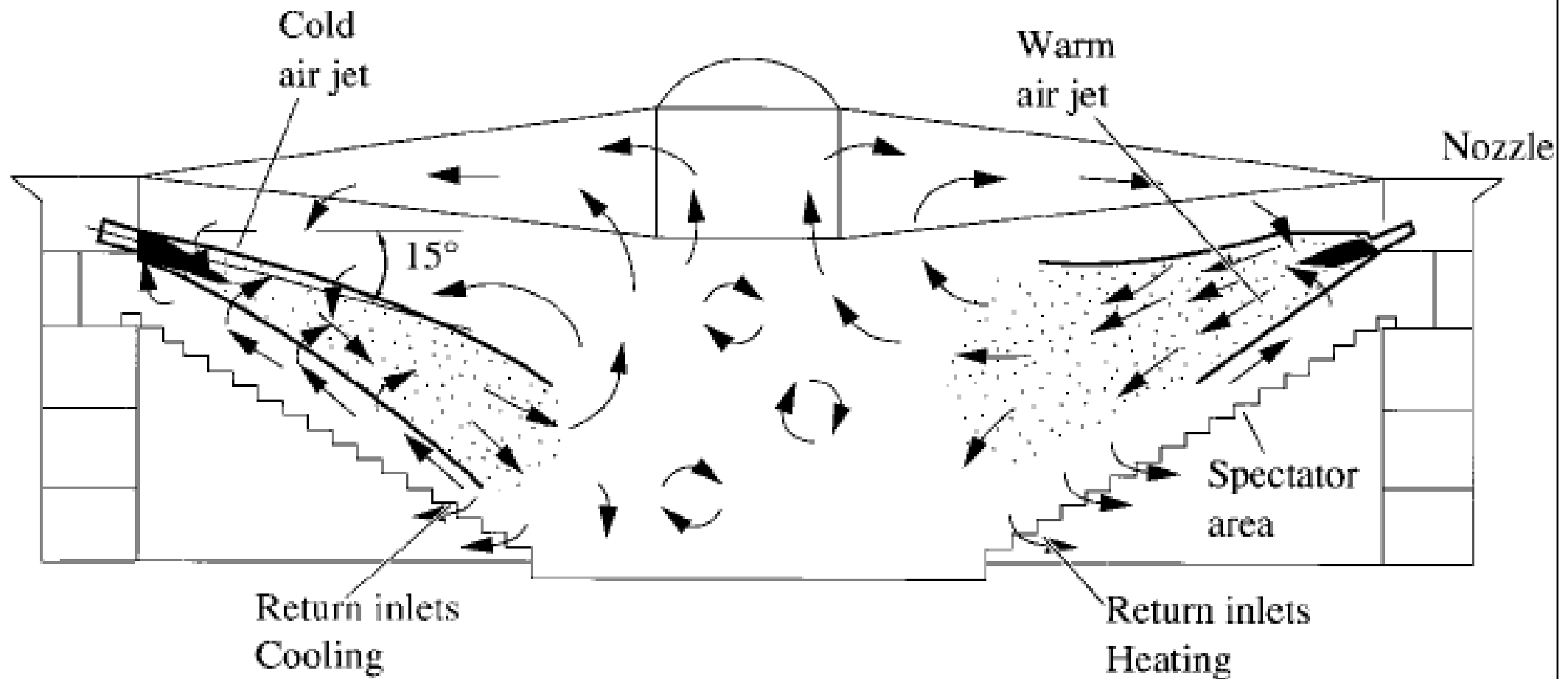

Hong Kong International Airport



Assembly hall air distribution

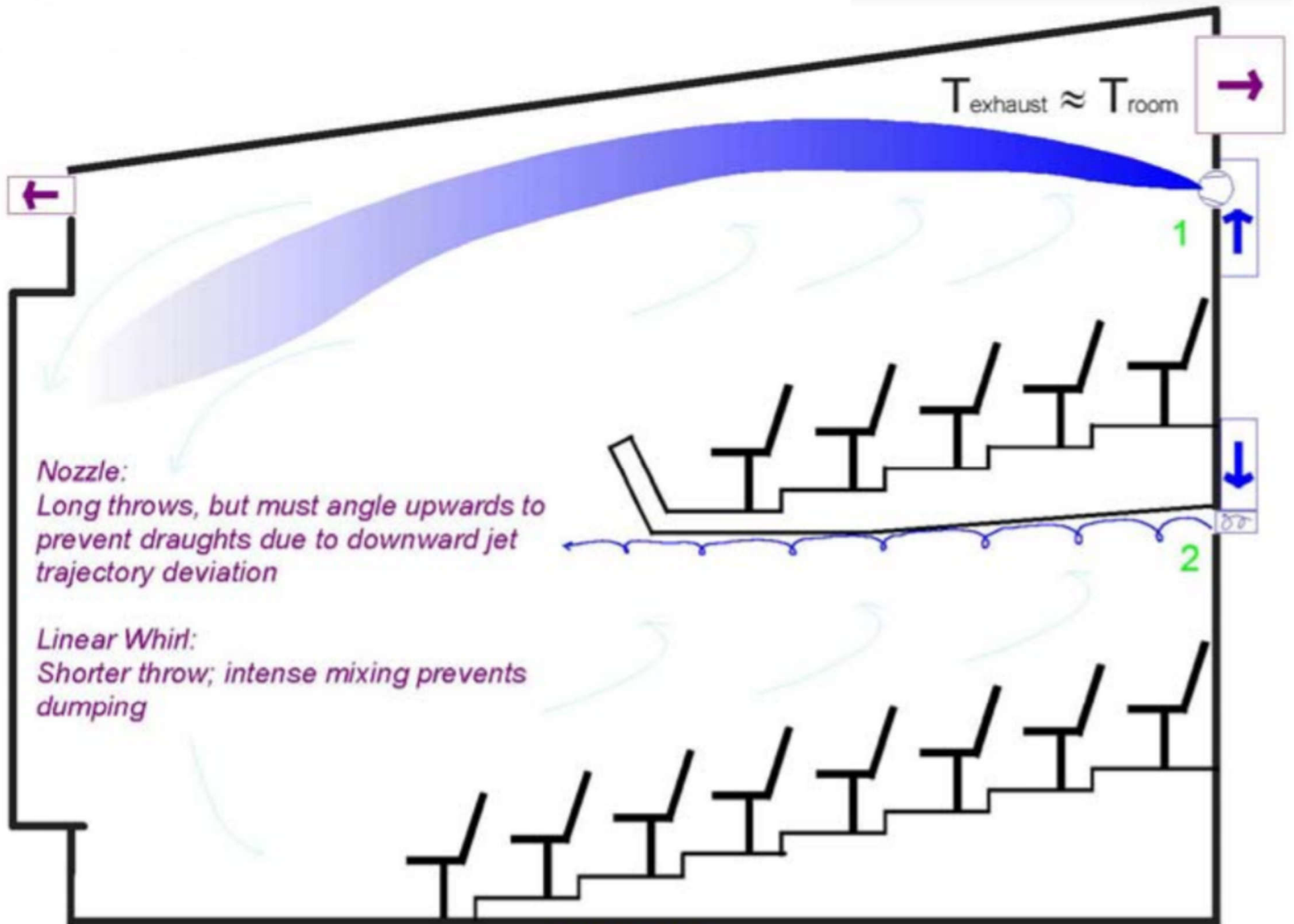

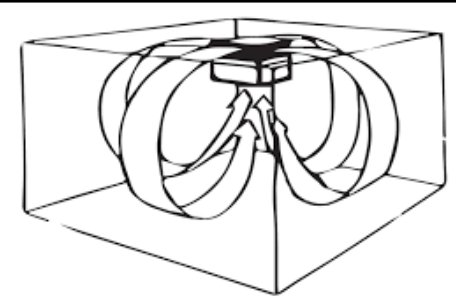

Design Issues

- Characteristics of stratified mixing flow
 - Convective heat transfer from hot roof is blocked
 - Cooling loads in lower zone is offset by supply air
 - Radiant heat from roof, wall & lights in upper zone enters the occupied zone and becomes cooling load
 - Although supply airflow rate & temp. affect the throw & drop of the air jet, the induced recirculating airflow patterns in upper & lower zones remain the same
 - Height of supply air jet determines upper boundary of the lower zone
 - Location of return inlets influences cooling load only when they are located in the upper zone

Design Issues

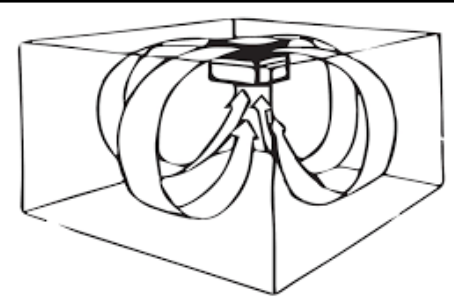

- Design & selection method
 - Review the form & use of the space, and determine if cooling or heating will be provided
 - Determine the amounts of airflow rates
 - Decide location for equipment
 - Obtain & review equipment catalogues (find acceptable styles & models of air terminals)
 - Lay out rough locations for air terminals
 - Select specific models & sizes

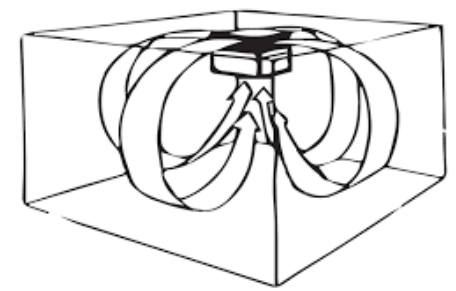

Design Issues

- Design & selection method (cont'd)
 - Check performance criteria (patterns, throws, sound levels, pressure drops)
 - Relocate, reselect, recheck if needed
 - Select any terminal boxes, size & lay out branch ductwork
 - Prepare schedules, drawings & specifications
 - Coordinate with other consultants (e.g. architect, interior designer)

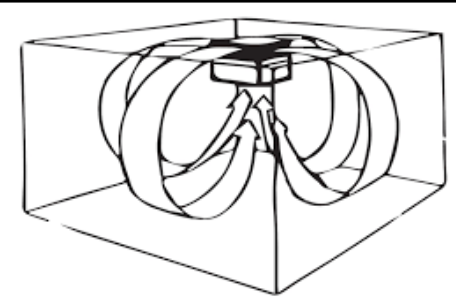

Design Issues

- Select type of supply outlet
 - Requirements of indoor environmental control
 - Such as precise air movement & air temperature
 - Shape, size, and ceiling height of the building
 - Surface effect
 - Volume flow per unit floor area
 - Determine the number of outlets
 - Appearance
 - Cost

Table 1 Guide to Use of Various Outlets

Type of Outlet	Air Loading of Floor Space, Max. L/s per m²	Approx. Max. Air Changes per Hour for 3 m Ceiling
Grille	3 to 6	7
Slot	4 to 10	12
Perforated panel	5 to 15	18
Ceiling diffuser	5 to 30	30

**Table 4 Air Diffusion Performance Index (ADPI)
Selection Guide**

Terminal Device	Room Load, W/m ²	$T_{0.25}/L$ for Maximum ADPI	Maximum ADPI	For ADPI Greater than	Range of $T_{0.25}/L$
High sidewall grilles	250	1.8	68	—	—
	190	1.8	72	70	1.5–2.2
	125	1.6	78	70	1.2–2.3
	65	1.5	85	80	1.0–1.9
Circular ceiling diffusers	250	0.8	76	70	0.7–1.3
	190	0.8	83	80	0.7–1.2
	125	0.8	88	80	0.5–1.5
	65	0.8	93	90	0.7–1.3
Sill grille, straight vanes	250	1.7	61	60	1.5–1.7
	190	1.7	72	70	1.4–1.7
	125	1.3	86	80	1.2–1.8
	65	0.9	95	90	0.8–1.3
Sill grille, spread vanes	250	0.7	94	90	0.6–1.5
	190	0.7	94	80	0.6–1.7
	125	0.7	94	—	—
	65	0.7	94	—	—
Ceiling slot diffusers (for T_{100}/L)	250	0.3	85	80	0.3–0.7
	190	0.3	88	80	0.3–0.8
	125	0.3	91	80	0.3–1.1
	65	0.3	92	80	0.3–1.5
Light troffer diffusers	190	2.5	86	80	<3.8
	125	1.0	92	90	<3.0
	65	1.0	95	90	<4.5
Perforated, louvered ceiling diffusers	35–160	2.0	96	90	1.4–2.7
				80	1.0–3.4

[Source: *ASHRAE Handbook Fundamentals 2001*, Chapter 32]

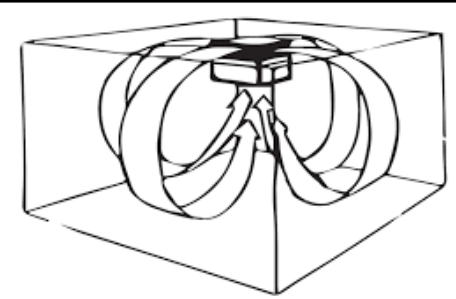

Design Issues

- Select & check the specific supply outlet
 - Major parameters
 - Sound level
 - Combined sound level shall be at least 3 dB lower than the recommended NC criteria
 - Typical air velocities: 2.5 to 6.25 m/s
 - Drop of cold air jet
 - Will cold air jet enter the occupied zone?
 - Total pressure loss
 - Typically, total pressure loss shall be lower than 50 Pa

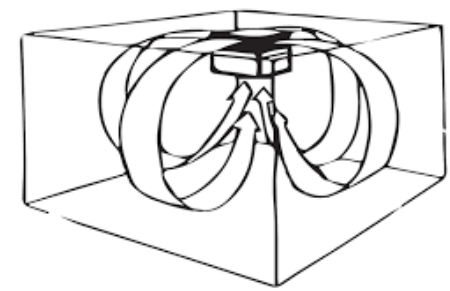

Design Issues

- Determination of the final layout is often an iteration process
- Some good practices for return inlets:
 - If a ceiling plenum is used as return plenum, return inlets shall be located outside supply air jet, above return airstream, or near a concentrated heat source
 - Recommended face velocities for return inlets:
 - Above occupied zone: 4 to 5 m/s
 - Within occupied zone: 2 to 3 m/s
 - Door louvres: 1.5 to 2.5 m/s



Further Reading

- Price Industries Training (videos)

<https://www.priceindustries.com/resources?Category=Videos>

- HVAC Training - Comfort Criteria (10:07)

<https://youtu.be/FRERtz0Ez-c>

- Space Air Diffusion (8:49) <https://youtu.be/5ReA3B2eINM>

- Air Outlet Selection (31:21) <https://youtu.be/GpXMTL10FGY>

- NPTEL E-learning course -- Refrigeration and Air Conditioning <http://nptel.ac.in/courses/112105129/>

- Lesson 39 Space Air Distribution

<https://nptel.ac.in/content/storage2/courses/112105129/pdf/R&AC%20Lecture%2039.pdf>

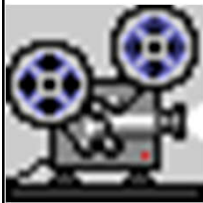

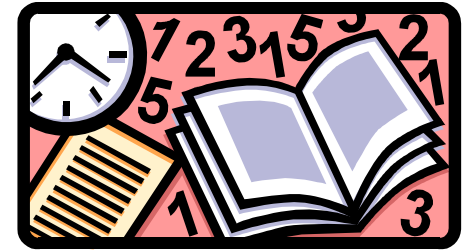

References

- ASHRAE, 2017. *ASHRAE Fundamentals Handbook 2017*, SI edition, Chp. 20 - Space Air Diffusion, American Society of Heating, Refrigerating, and Air-Conditioning Engineers, Atlanta, GA.
- ASHRAE, 2016. *ASHRAE Systems and Equipment Handbook 2016*, SI edition, Chp. 20 - Room Air Distribution Equipment, American Society of Heating, Refrigerating, and Air-Conditioning Engineers, Atlanta, GA.
- Heiselberg, P., Murakarni, S. and Roulet, C.-A. (eds.), 1998. *Ventilation of Large Spaces in Buildings: Analysis and Prediction Techniques*, IEA Energy Conservation in Buildings and community Systems, Annex 26: Energy Efficient Ventilation of Large Enclosures, Aalborg University, Aalborg, Denmark. [[PDF](#)]

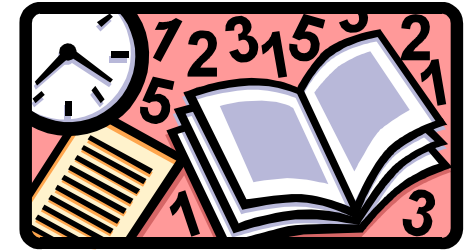

References

- HVACMA (Heating Ventilating and Air Conditioning Manufacturers Association), 2000. *Guide to Air Distribution Technology for the Internal Environment*, Federation of Environmental Trade Associations, Marlow, Bucks, UK. [P 697.932 G9]
<http://seedengr.com/Guide%20to%20Air%20Distribution%20Technology%202000.pdf>
- Rock, B. A. and Zhu, D., 2002. *Designer's Guide to Ceiling-based Air Diffusion*, American Society of Heating, Refrigerating and Air-Conditioning Engineers, Atlanta, GA. [697.92 R68]
- Wang, S. K., 2001. *Handbook of Air Conditioning and Refrigeration*, 2nd ed., Chp. 18, McGraw-Hill, New York. [697.93 W24 h]