

## Load Estimation



*Dr. Sam C. M. Hui*

Department of Mechanical Engineering

The University of Hong Kong

E-mail: [cmhui@hku.hk](mailto:cmhui@hku.hk)

# Contents

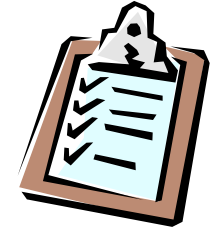

- Basic Concepts
- Outdoor Design Conditions
- Indoor Design Conditions
- Cooling Load Components
- Cooling Load Principles
- Cooling Coil Load
- Heating Load
- Software Applications

# Basic Concepts

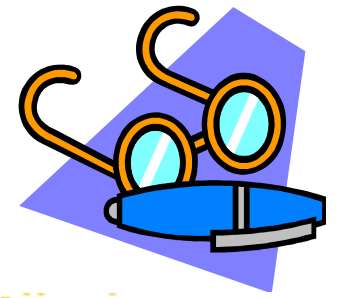

- Heat transfer mechanism

- Conduction
- Convection
- Radiation

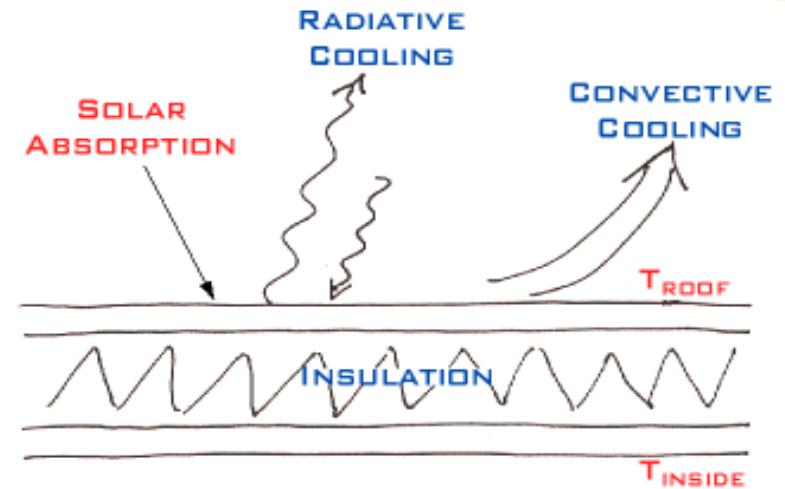

$$Q_{IN} = U \cdot (T_{ROOF} - T_{INSIDE})$$

- Thermal properties of building materials

- Overall thermal transmittance (U-value)
- Thermal conductivity
- Thermal capacity (specific heat)

$$Q = U A (\Delta t)$$

# Basic Concepts

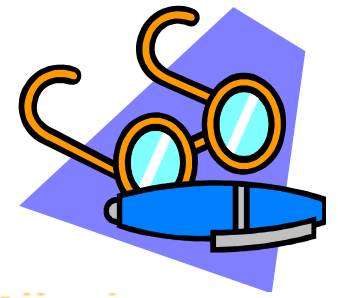

- Thermal transmission in buildings
  - [http://www.arca53.dsl.pipex.com/index\\_files/tt1.htm](http://www.arca53.dsl.pipex.com/index_files/tt1.htm)
  - External walls, windows, roof, doors and floors
  - Insulation (thermal) to reduce the heat transfer
  - Ventilation (infiltration and exfiltration)
  - Thermal properties of building materials and construction components
  - Examples of U-value calculations
    - [http://www.arca53.dsl.pipex.com/index\\_files/tt4.htm](http://www.arca53.dsl.pipex.com/index_files/tt4.htm)

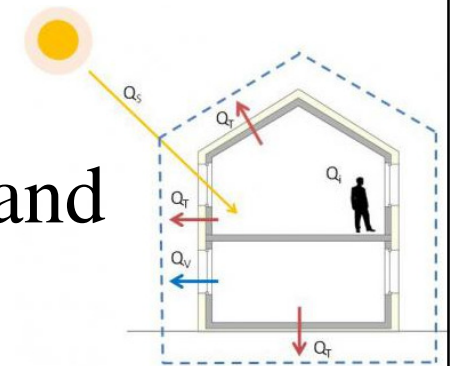

# Basic Concepts

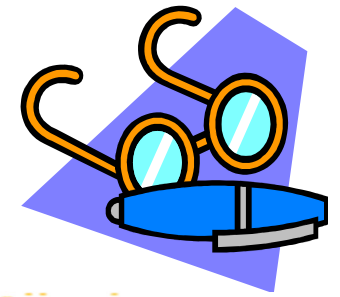

- Calculating heat gains

- [http://www.arca53.dsl.pipex.com/index\\_files/hgain1.htm](http://www.arca53.dsl.pipex.com/index_files/hgain1.htm)

- Heat gain through external walls

- Heat gain through roof

- Solar heat gain through window glass

- Conduction heat through window glass

- Internal heat gains

- Ventilation and/or infiltration heat gains

- Latent heat gains (moisture transfer/generation)

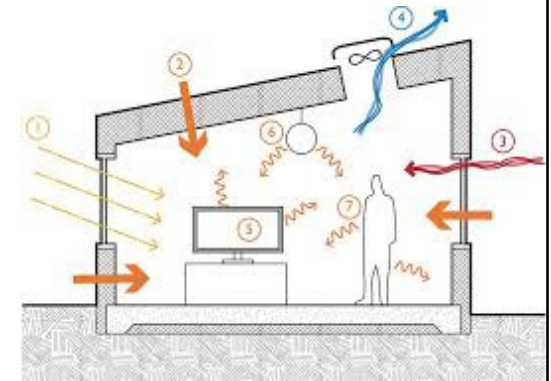

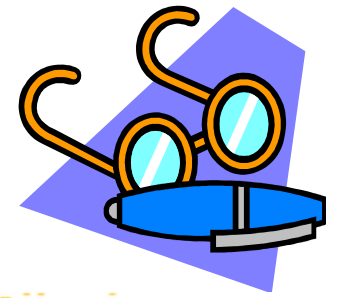

# Basic Concepts

- Heat transfer basic relationships (for air at sea level) (SI units)
  - Sensible heat transfer rate:
    - $q_{\text{sensible}} = 1.23 \text{ (Flow rate, L/s)} (\Delta t)$
  - Latent heat transfer rate:
    - $q_{\text{latent}} = 3010 \text{ (Flow rate, L/s)} (\Delta w)$
  - Total heat transfer rate:
    - $q_{\text{total}} = 1.2 \text{ (Flow rate, L/s)} (\Delta h)$
  - $q_{\text{total}} = q_{\text{sensible}} + q_{\text{latent}}$

# Basic Concepts

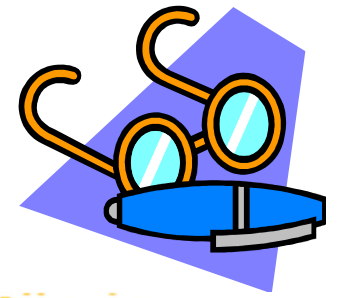

- Thermal load
  - The amount of heat that must be added or removed from the space to maintain the proper temperature in the space
- When thermal loads push conditions outside of the comfort range, HVAC systems are used to bring the thermal conditions back to comfort conditions



# Basic Concepts

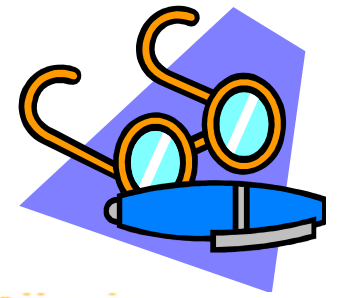

- Purpose of HVAC load estimation
  - Calculate peak design loads (cooling/heating)
  - Estimate likely plant/equipment capacity or size
  - Specify the required airflow to individual spaces
  - Provide info for HVAC design e.g. load profiles
  - Form the basis for building energy analysis
- Cooling load is our main target
  - Important for warm climates & summer design
  - Affect building performance & its first cost



# Basic Concepts

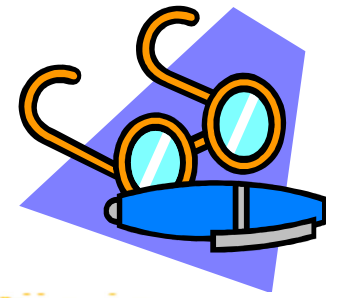

- General procedure for cooling load calculations
  - 1. Obtain the characteristics of the building, building materials, components, etc. from building plans and specifications
  - 2. Determine the building location, orientation, external shading (like adjacent buildings)
  - 3. Obtain appropriate weather data and select outdoor design conditions
  - 4. Select indoor design conditions (include permissible variations and control limits)

# Basic Concepts

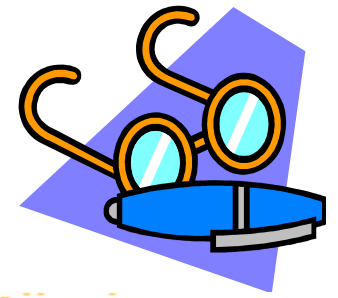

- General procedure for cooling load calculations (cont'd)
  - 5. Obtain a proposed schedule of lighting, occupants, internal equipment appliances and processes that would contribute to internal thermal load
  - 6. Select the time of day and month for the cooling load calculation
  - 7. Calculate the space cooling load at design conditions
  - 8. Assess the cooling loads at several different time or a design day to find out the peak design load

# Total Cooling Load - Tons

January Through June

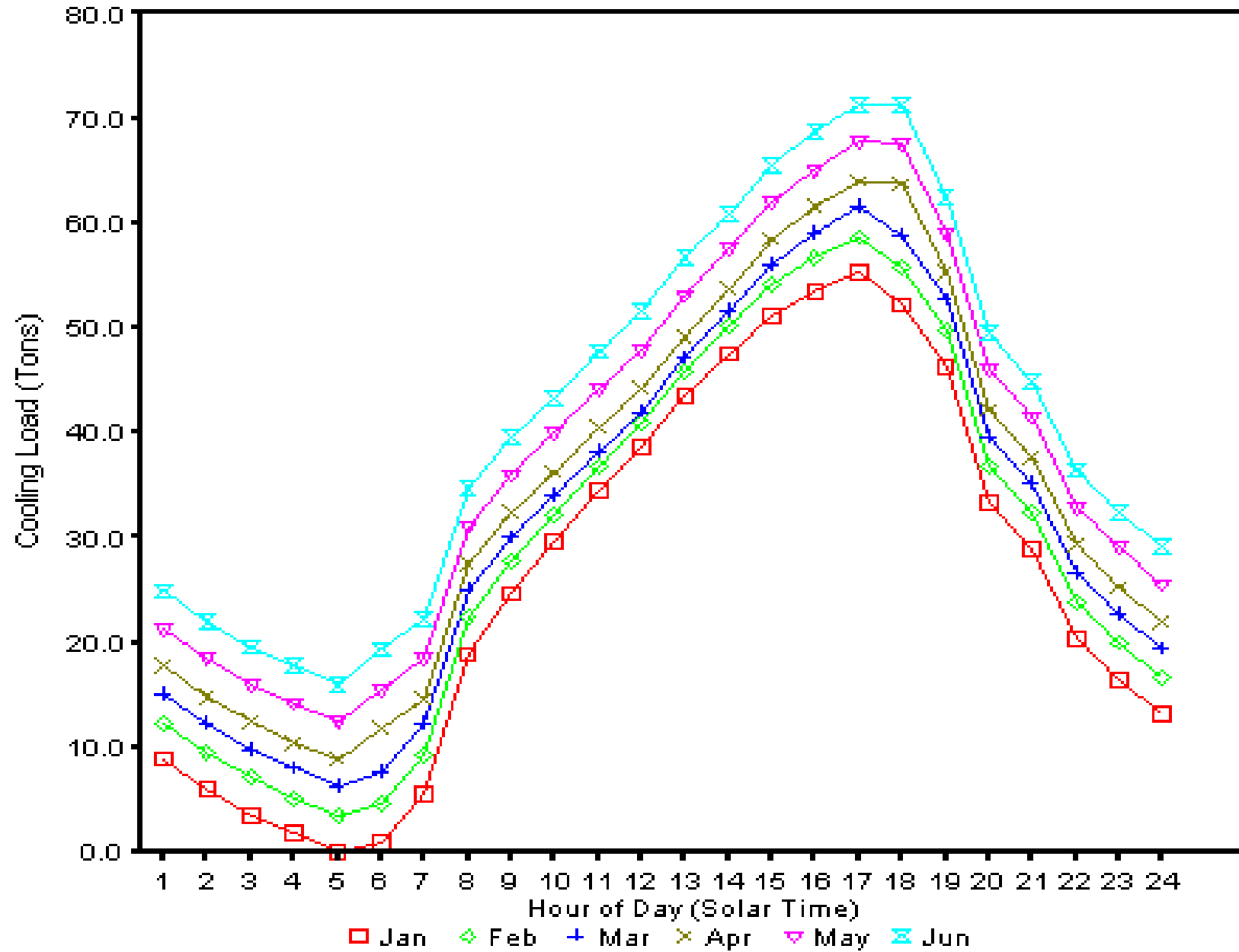

Cooling load profiles

# Basic Concepts

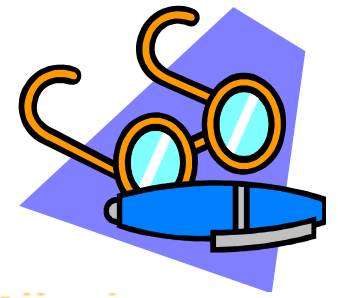

- A building survey will help us achieve a realistic estimate of thermal loads
  - Orientation of the building
  - Use of spaces
  - Physical dimensions of spaces
  - Ceiling height
  - Columns and beams
  - Construction materials
  - Surrounding conditions
  - Windows, doors, stairways

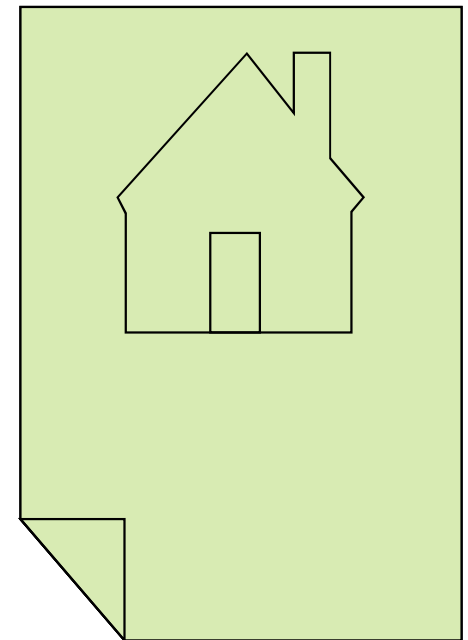

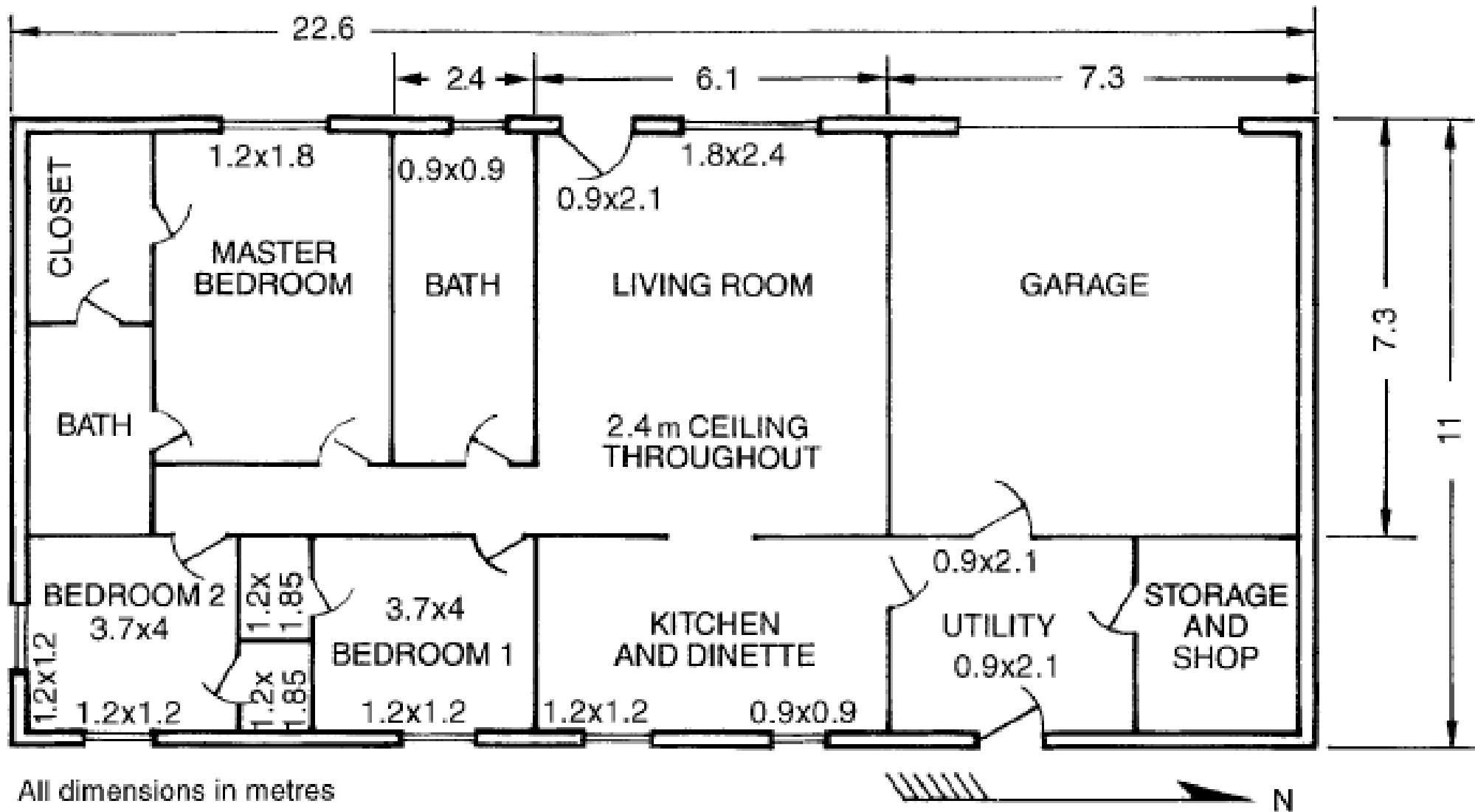

# Basic Concepts

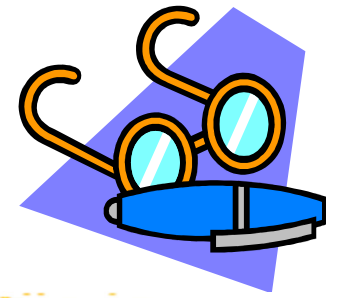

- Key info for load estimation
  - People (number or density, duration of occupancy, nature of activity)
  - Lighting ( $\text{W}/\text{m}^2$ , type)
  - Appliances (wattage, location, usage)
  - Ventilation (criteria, requirements)
  - Thermal storage (if any)
  - Continuous or intermittent operation

# Basic Concepts

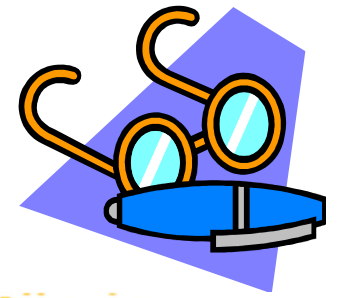

- Typical HVAC load design process
  - 1. Rough estimates of design loads & energy use
    - Such as by rules of thumb & floor areas
    - See “Cooling Load Check Figures” \*
    - See references for some examples of databooks
  - 2. Develop & assess more info (design criteria, building info, system info)
    - Building layouts & plans are developed
  - 3. Perform detailed load & energy calculations

(\* Cooling Load Check Figures [http://www.iklimnet.com/expert\\_hvac/cooling\\_load\\_check\\_figures.html](http://www.iklimnet.com/expert_hvac/cooling_load_check_figures.html);  
[http://me.hku.hk/bse/cpd/HVACdesign-L1/CoolingLoadCheckFigures\\_CLTDequations.pdf](http://me.hku.hk/bse/cpd/HVACdesign-L1/CoolingLoadCheckFigures_CLTDequations.pdf))

# Outdoor Design Conditions

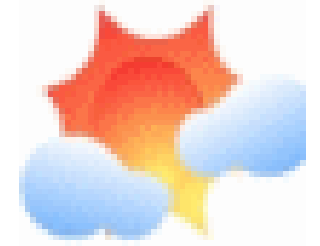

- They are used to calculate design space loads
- Climatic design information
  - General info: e.g. latitude, longitude, altitude, atmospheric pressure
  - Outdoor design conditions include
    - Derived from statistical analysis of weather data
    - Typical data can be found in handbooks/databooks, such as ASHRAE Fundamentals Handbook



# Outdoor Design Conditions

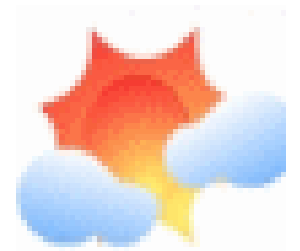

- Climatic design conditions (ASHRAE, 2009):
  - Annual heating & humidif. design conditions
    - Coldest month
    - Heating dry-bulb (DB) temp.
    - Humidification dew point (DP)/ mean coincident dry-bulb temp. (MCDB) and humidity ratio (HR)
    - Coldest month wind speed (WS)/mean coincident dry-bulb temp. (MCDB)
    - Mean coincident wind speed (MCWS) & prevailing coincident wind direction (PCWD) to 99.6% DB

# Outdoor Design Conditions

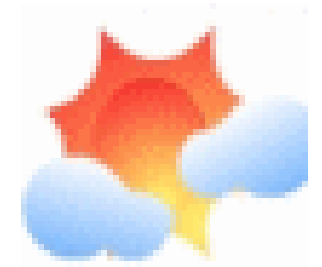

- Climatic design conditions (ASHRAE, 2009):
  - Cooling and dehumidification design conditions
    - Hottest month and DB range
    - Cooling DB/MCWB: Dry-bulb temp. (DB) + Mean coincident wet-bulb temp. (MCWB)
    - Evaporation WB/MCDB: Web-bulb temp. (WB) + Mean coincident dry-bulb temp. (MCDB)
    - MCWS/PCWD to 0.4% DB
    - Dehumidification DP/MCDB and HR: Dew-point temp. (DP) + MDB + Humidity ratio (HR)
    - Enthalpy/MCDB

# Outdoor Design Conditions

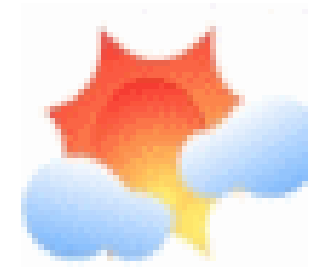

- Climatic design conditions (ASHRAE, 2009):
  - Extreme annual design conditions
  - Monthly climatic design conditions
    - Temperature, degree-days and degree-hours
    - Monthly design DB and mean coincident WB
    - Monthly design WB and mean coincident DB
    - Mean daily temperature range
    - Clear sky solar irradiance

# Recommended Outdoor Design Conditions for Hong Kong

Location	Hong Kong (latitude 22° 18' N, longitude 114° 10' E, elevation 33 m)				
Weather station	Royal Observatory Hong Kong				
Summer months	June to September (four hottest months), total 2928 hours				
Winter months	December, January & February (three coldest months), total 2160 hours				
Design temperatures:	For comfort HVAC (based on summer 2.5% or annualised 1% and winter 97.5% or annualised 99.3%)		For critical processes (based on summer 1% or annualised 0.4% and winter 99% or annualised 99.6%)		
	Summer	Winter	Summer	Winter	
	DDB / CWB	32.0 °C / 26.9 °C	9.5 °C / 6.7 °C	32.6 °C / 27.0 °C	8.2 °C / 6.0 °C
	CDB / DWB	31.0 °C / 27.5 °C	10.4 °C / 6.2 °C	31.3 °C / 27.8 °C	9.1 °C / 5.0 °C

- Note:
1. DDB is the design dry-bulb and CWB is the coincident wet-bulb temperature with it; DWB is the design wet-bulb and CDB is the coincident dry-bulb with it.
  2. The design temperatures and daily ranges were determined based on hourly data for the 35-year period from 1960 to 1994; extreme temperatures were determined based on extreme values between 1884-1939 and 1947-1994.

(Source: Research findings from Dr. Sam C M Hui)

## Recommended Outdoor Design Conditions for Hong Kong (cont'd)

Extreme temperatures:	Hottest month: July mean DBT = 28.6 °C absolute max. DBT = 36.1 °C mean daily max. DBT = 25.7 °C		Coldest month: January mean DBT = 15.7 °C absolute min. DBT = 0.0 °C mean daily min. DBT = 20.9 °C	
Diurnal range:	Summer	Winter	Whole year	
- Mean DBT	28.2	16.4	22.8	
- Daily range	4.95	5.01	5.0	
Wind data:	Summer	Winter	Whole year	
- Wind direction	090 (East)	070 (N 70° E)	080 (N 80° E)	
- Wind speed	5.7 m/s	6.8 m/s	6.3 m/s	

Note: 3. Wind data are the prevailing wind data based on the weather summary for the 30-year period 1960-1990. Wind direction is the prevailing wind direction in degrees clockwise from north and the wind speed is the mean prevailing wind speed.

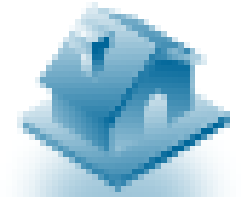

# Indoor Design Conditions

- Basic design parameters: (for thermal comfort)
  - Air temp. & air movement
    - Typical: summer 24-26 °C; winter 21-23 °C
    - Air velocity: summer < 0.25 m/s; winter < 0.15 m/s
  - Relative humidity
    - Summer: 40-50% (preferred), 30-65 (tolerable)
    - Winter: 25-30% (with humidifier); not specified (w/o humidifier)
  - See also ASHRAE Standard 55
    - ASHRAE comfort zone



# Indoor Design Conditions

- Indoor air quality: (for health & well-being)
  - Air contaminants
    - e.g. particulates, VOC, radon, bioeffluents
  - Outdoor ventilation rate provided
    - ASHRAE Standard 62.1
  - Air cleanliness (e.g. for processing), air movement
- Other design parameters:
  - Sound level (noise criteria)
  - Pressure differential between the space & surroundings (e.g. +ve to prevent infiltration)

Type of area	Recommended NC or RC range (dB)
Hotel guest rooms	30–35
Office	
Private	30–35
Conference	25–30
Open	30–35
Computer equipment	40–45
Hospital, private	25–30
Churches	25–30
Movie theaters	30–35

(NC = noise criteria; RC = room criteria)

\* Remark: buildings in HK often have higher NC, say add 5-10 dB (more noisy).



# Inputs for cooling load calculations

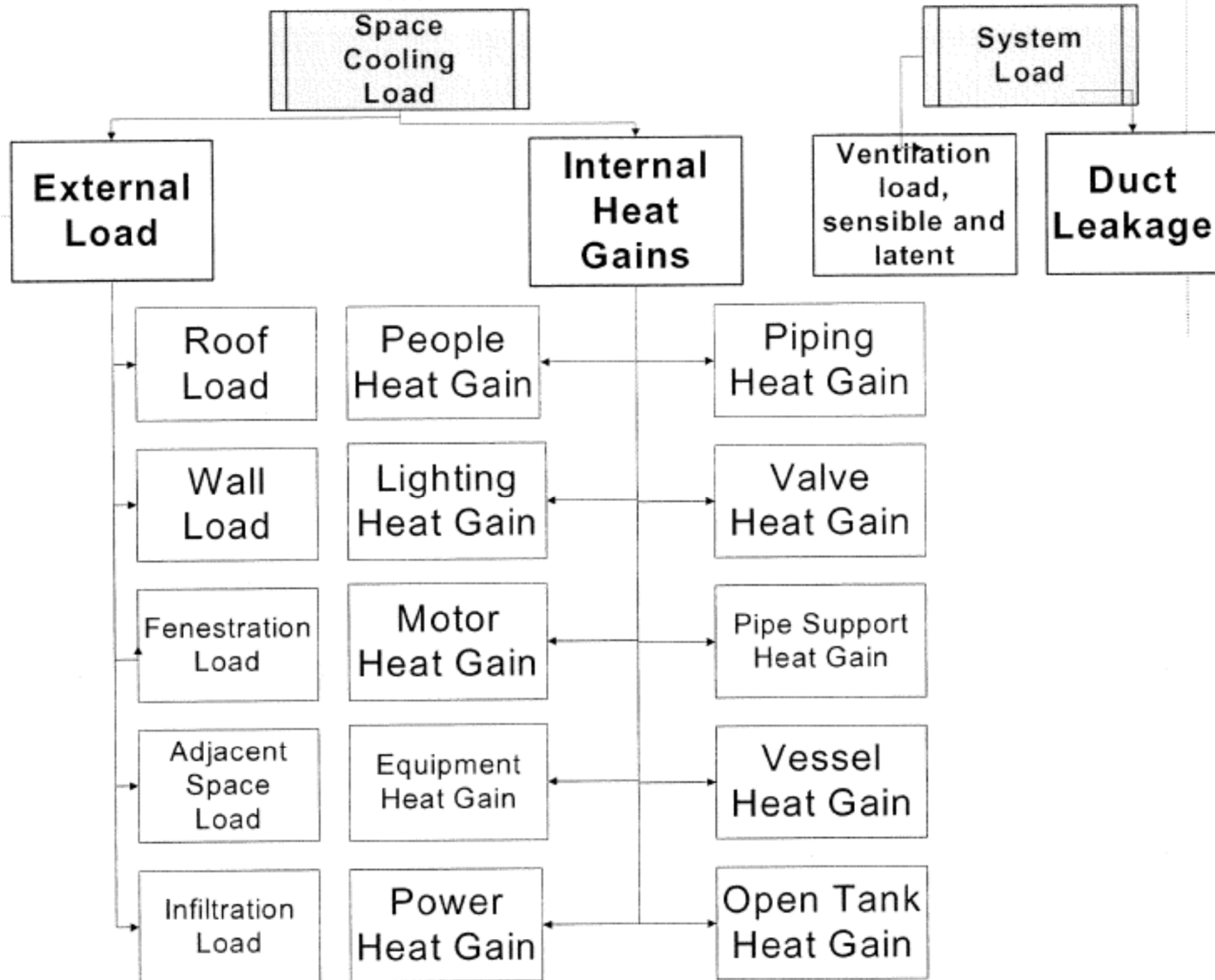

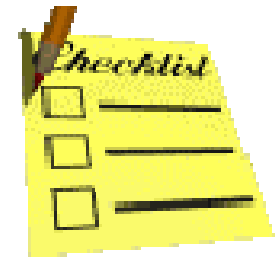

# Cooling Load Components

- External
  - 1. Heat gain through exterior walls and roofs
  - 2. Solar heat gain through fenestrations (windows)
  - 3. Conductive heat gain through fenestrations
  - 4. Heat gain through partitions & interior doors
- Internal
  - 1. People
  - 2. Electric lights
  - 3. Equipment and appliances

# Cooling Load Components

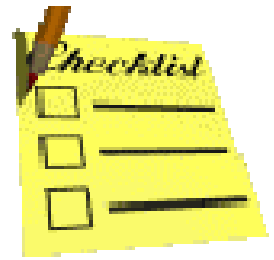

- Infiltration

- Air leakage and moisture migration, e.g. flow of outdoor air into a building through cracks, unintentional openings, normal use of exterior doors for entrance

- System (HVAC)

- Outdoor ventilation air
- System heat gain: duct leakage & heat gain, reheat, fan & pump energy, energy recovery

# Components of building cooling load

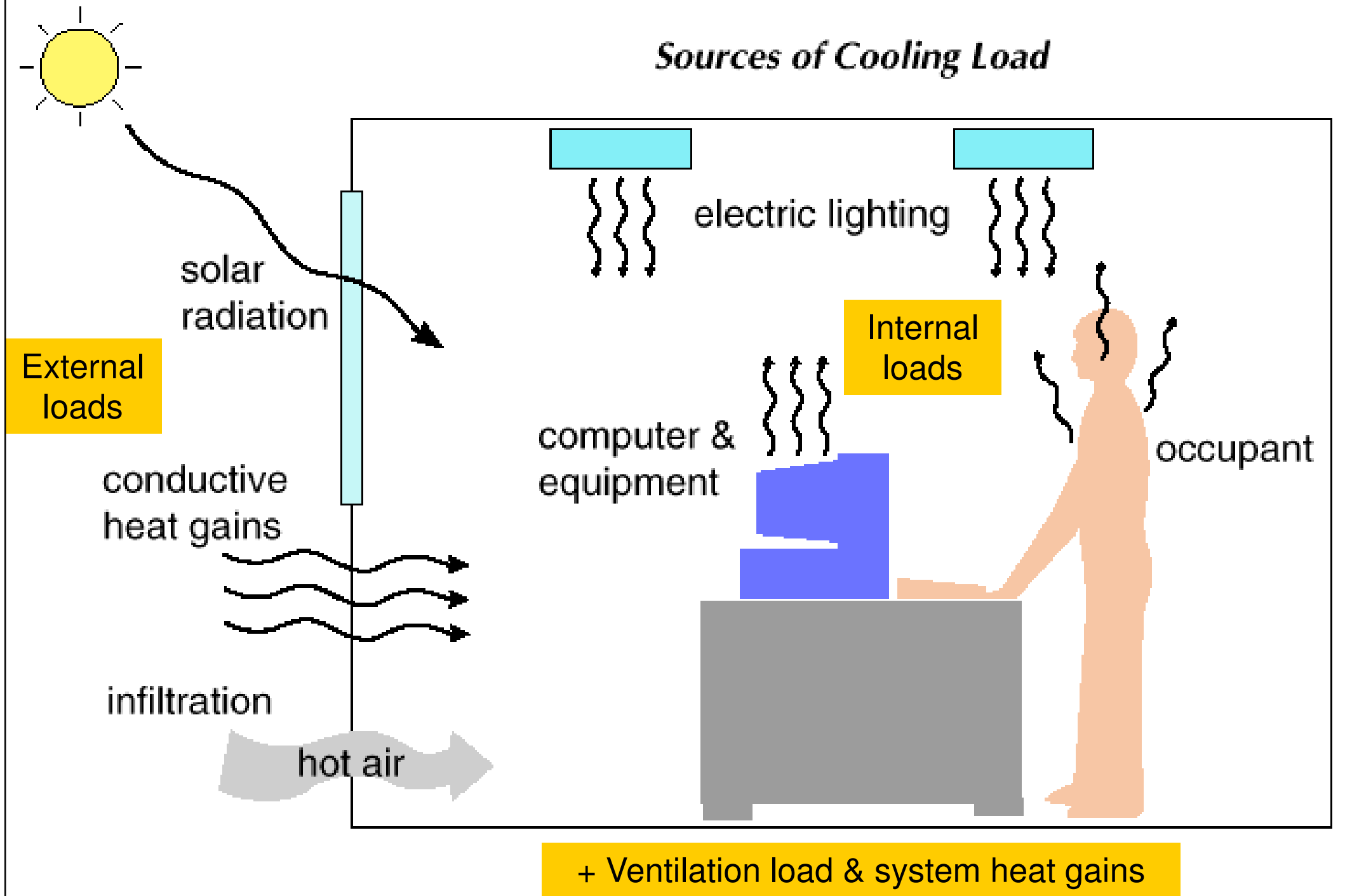

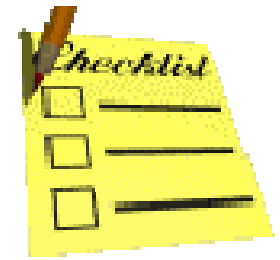

# Cooling Load Components

- Total cooling load
  - Sensible cooling load + Latent cooling load
  - =  $\Sigma(\text{sensible items}) + \Sigma(\text{latent items})$
- Which components have latent loads? Which only have sensible load? Why?
- Three major parts for load calculation
  - External cooling load
  - Internal cooling load
  - Ventilation and infiltration air

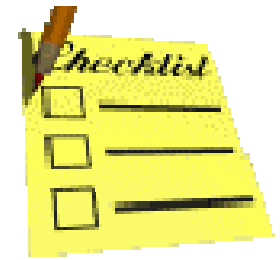

# Cooling Load Components

- Cooling load calculation method
  - Example: CLTD/SCL/CLF method
    - It is a one-step, simple calculation procedure developed by ASHRAE
    - CLTD = cooling load temperature difference
    - SCL = solar cooling load
    - CLF = cooling load factor
  - See ASHRAE Handbook Fundamentals for details
    - Tables for CLTD, SCL and CLF

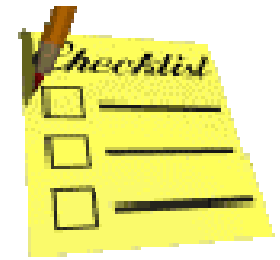

# Cooling Load Components

- External
  - Roofs, walls, and glass conduction
    - $q = U A$  (CLTD)       $U = U\text{-value}; A = \text{area}$
  - Solar load through glass
    - $q = A (SC)$  (SCL)      SC = shading coefficient
      - For unshaded area and shaded area
  - Partitions, ceilings, floors
    - $q = U A (t_{\text{adjacent}} - t_{\text{inside}})$

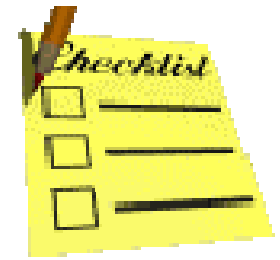

# Cooling Load Components

- Internal
  - People
    - $q_{\text{sensible}} = N$  (Sensible heat gain) (CLF)
    - $q_{\text{latent}} = N$  (Latent heat gain)
  - Lights
    - $q = \text{Watt} \times F_{\text{ul}} \times F_{\text{sa}}$  (CLF)
      - $F_{\text{ul}}$  = lighting use factor;  $F_{\text{sa}}$  = special allowance factor
  - Appliances
    - $q_{\text{sensible}} = q_{\text{input}} \times \text{usage factors}$  (CLF)
    - $q_{\text{latent}} = q_{\text{input}} \times \text{load factor}$  (CLF)



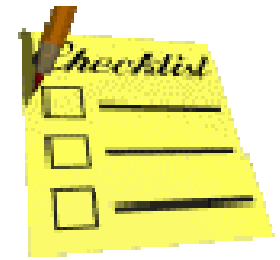

# Cooling Load Components

- Ventilation and infiltration air
  - $q_{\text{sensible}} = 1.23 Q (t_{\text{outside}} - t_{\text{inside}})$
  - $q_{\text{latent}} = 3010 Q (w_{\text{outside}} - w_{\text{inside}})$
  - $q_{\text{total}} = 1.2 Q (h_{\text{outside}} - h_{\text{inside}})$
- System heat gain
  - Fan heat gain
  - Duct heat gain and leakage
  - Ceiling return air plenum

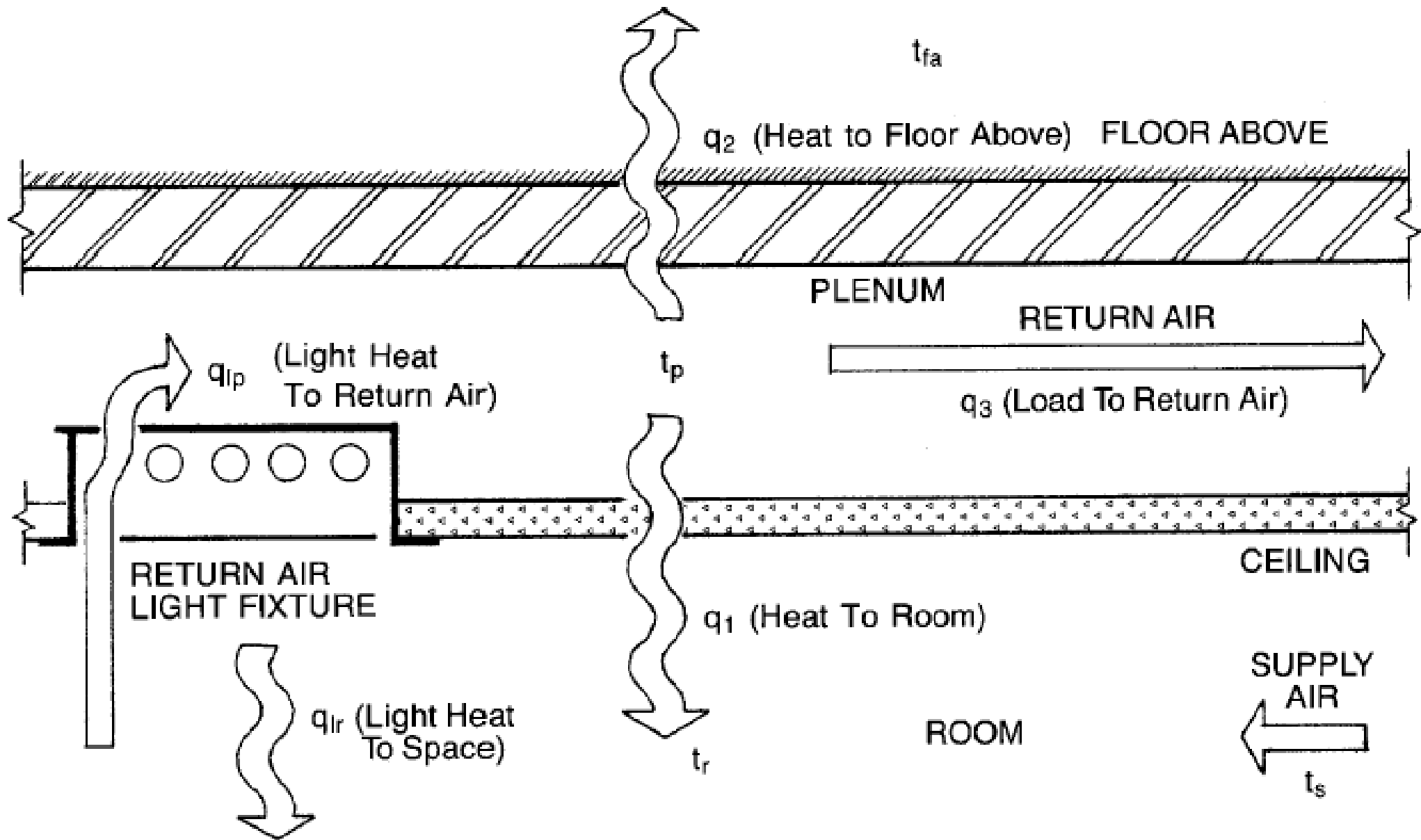

Schematic diagram of typical return air plenum

# Cooling Load Principles

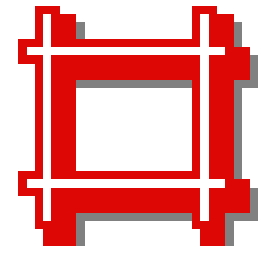

- Terminology:
  - Space – a volume w/o a partition, or a partitioned room, or group of rooms
  - Room – an enclosed space (a single load)
  - Zone – a space, or several rooms, or units of space having some sort of coincident loads or similar operating characteristics
    - Thermal zoning

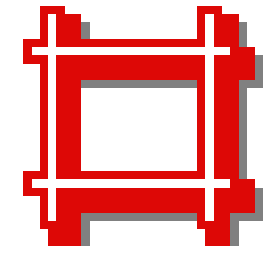

# Cooling Load Principles

- Definitions

- Space heat gain: instantaneous rate of heat gain that enters into or is generated within a space
- Space cooling load: the rate at which heat must be removed from the space to maintain a constant space air temperature
- Space heat extraction rate: the actual rate of heat removal when the space air temp. may swing
- Cooling coil load: the rate at which energy is removed at a cooling coil serving the space

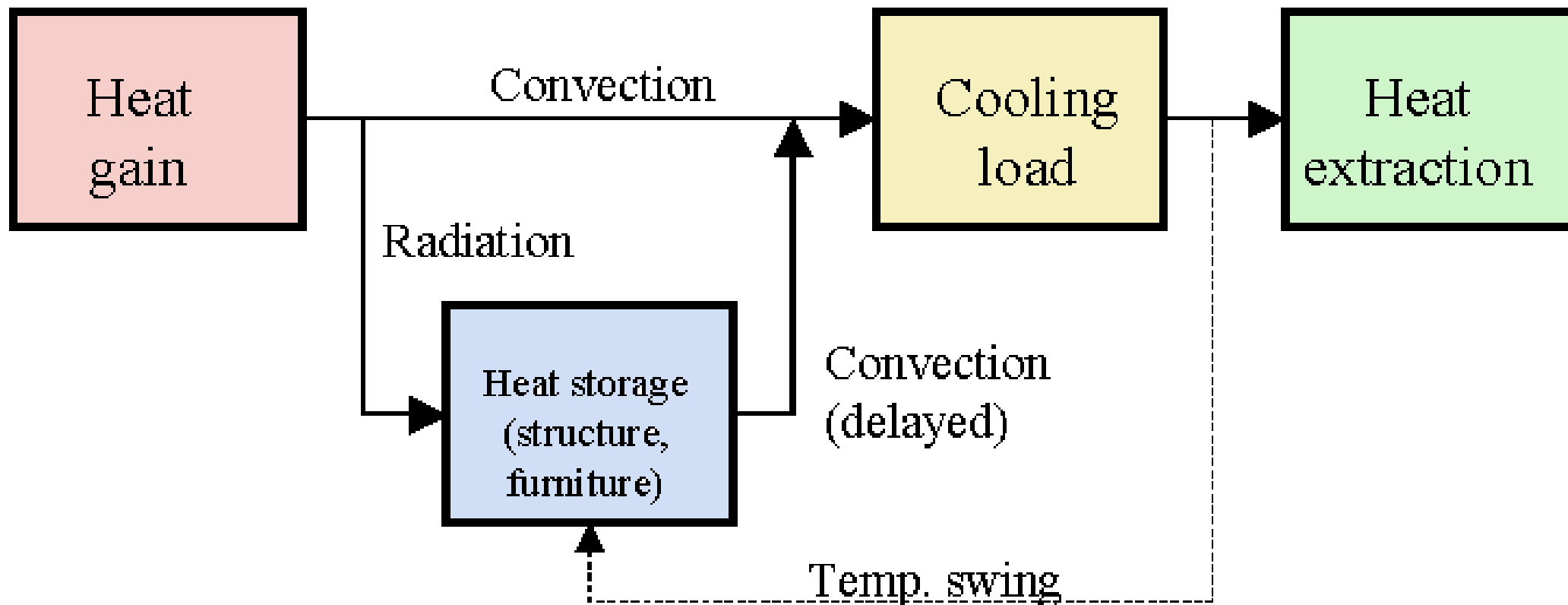

Conversion of heat gain into cooling load

# Cooling Load Principles

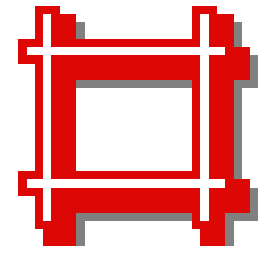

- Instantaneous heat gain vs space cooling loads
  - They are NOT the same
- Effect of heat storage
  - Night shutdown period
    - HVAC is switched off. What happens to the space?
  - Cool-down or warm-up period
    - When HVAC system begins to operate
    - Need to cool or warm the building fabric
  - Conditioning period
    - Space air temperature within the limits

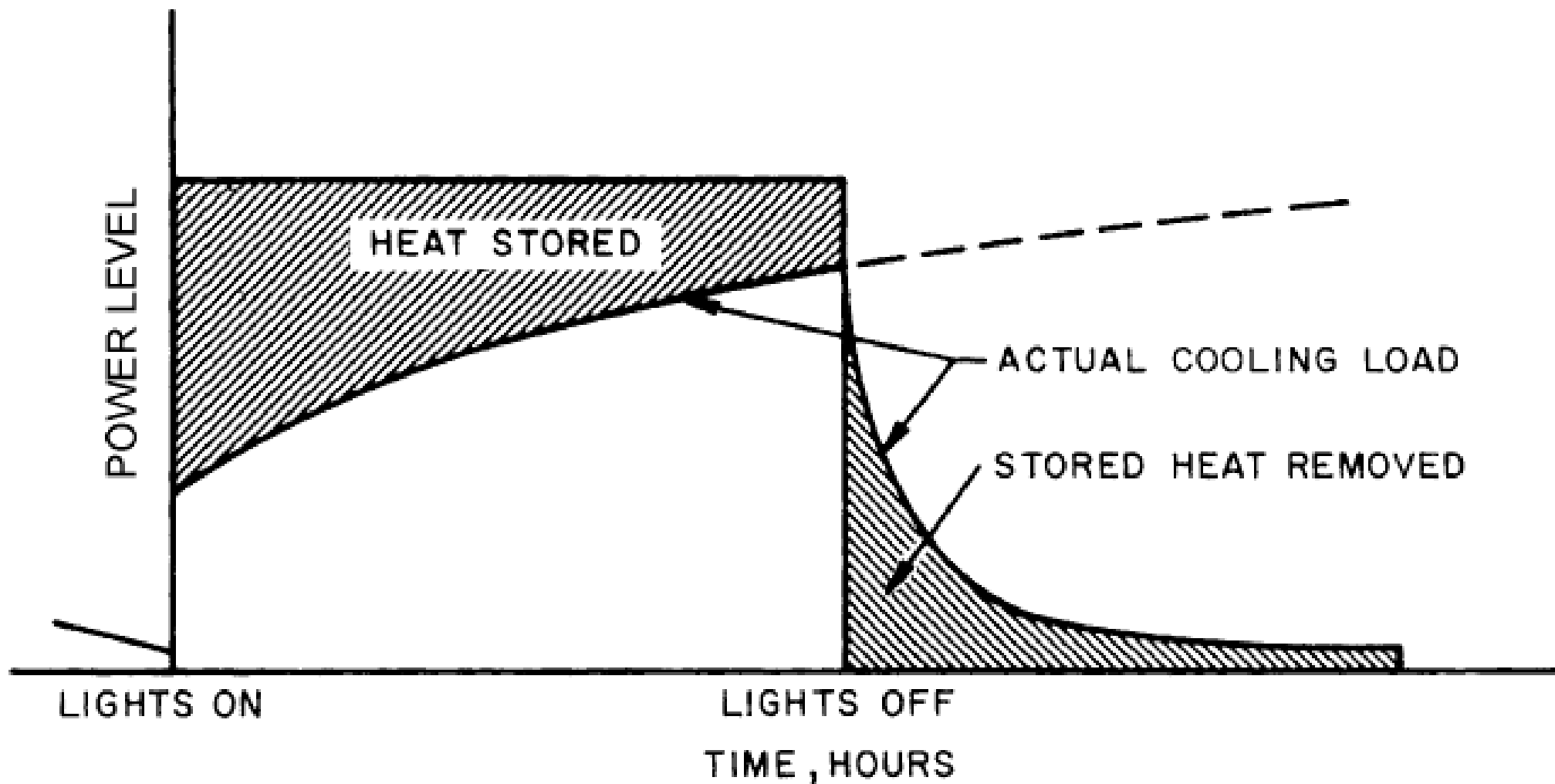

## Thermal Storage Effect in Cooling Load from Lights

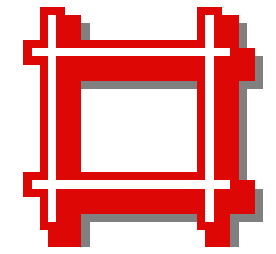

# Cooling Load Principles

- Space load and equipment load
  - Space heat gain (sensible, latent, total)
  - Space cooling / heating load [*at building*]
  - Space heat extraction rate
  - Cooling / heating coil load [*at air-side system*]
  - Refrigeration load [*at the chiller plant*]
- Instantaneous heat gain
  - Convective heat
  - Radiative heat (heat absorption)



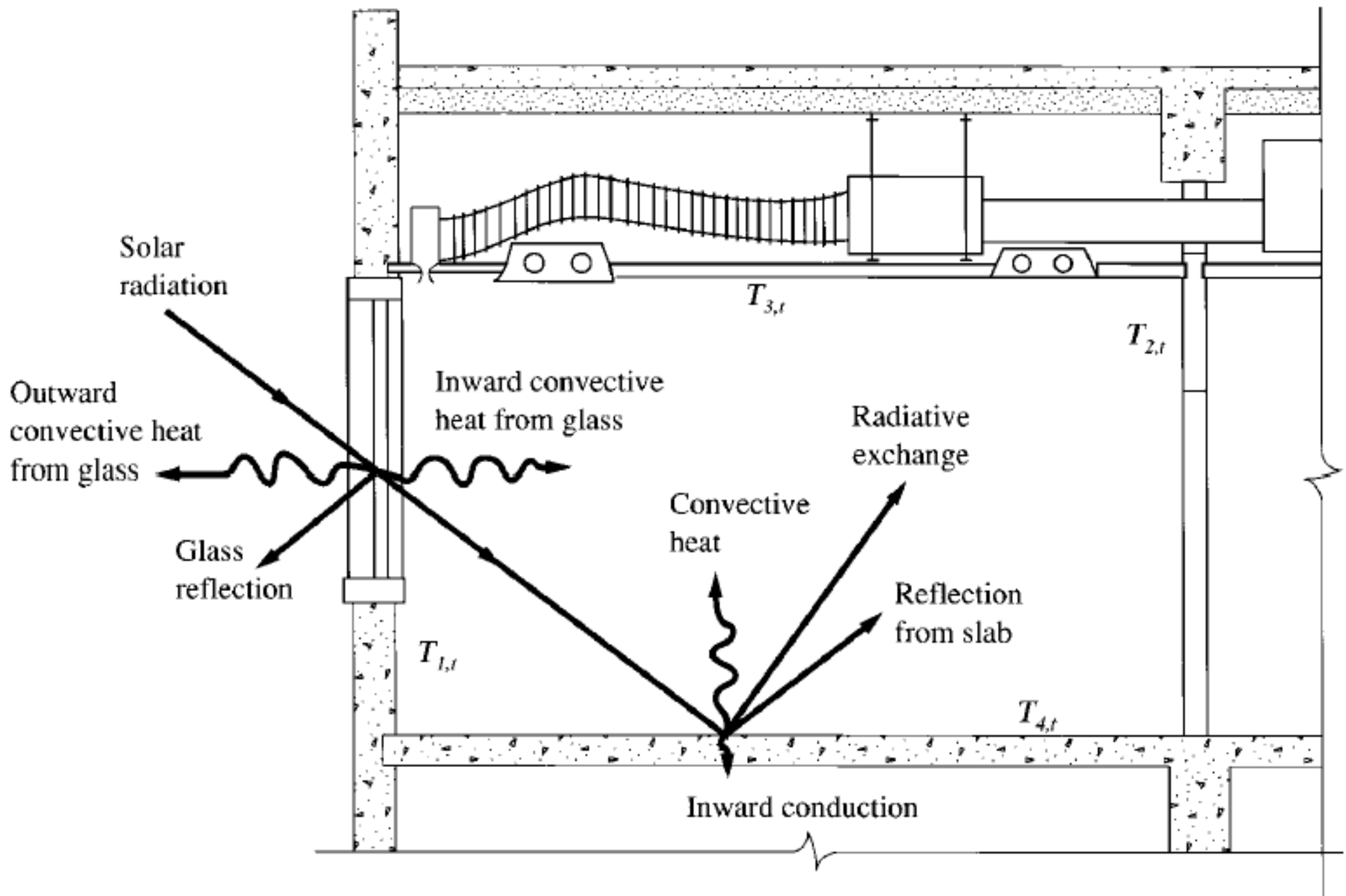

## Convective and radiative heat in a conditioned space

<b>Sensible heat gains</b>	<b>Convective (%)</b>	<b>Radiative (%)</b>
Solar radiation with internal shading	42	58
Fluorescent lights	50	50
Occupants	67	33
External wall, inner surface	40	60

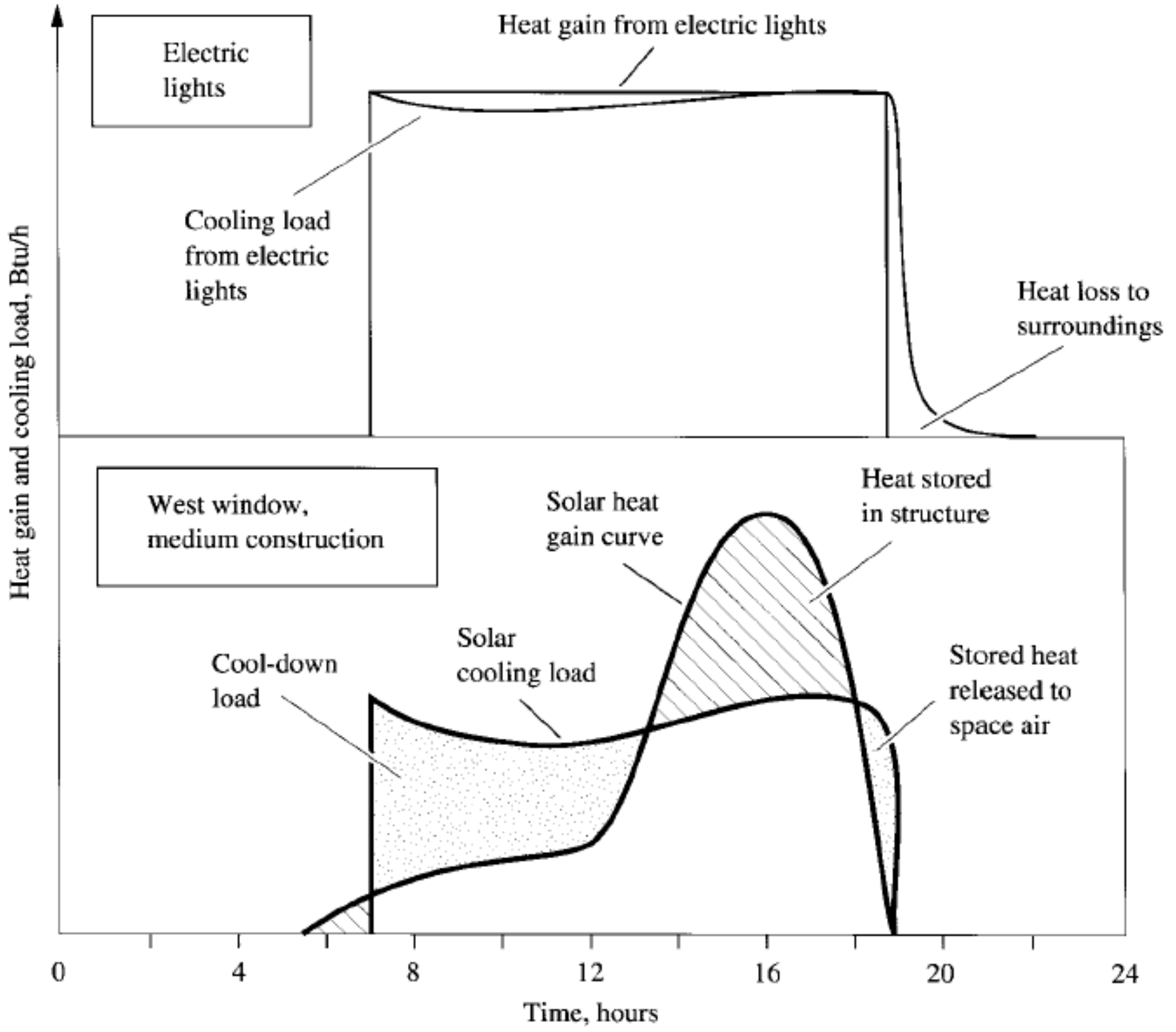

(Source: Wang, S. K., 2001. *Handbook of Air Conditioning and Refrigeration*, 2nd ed.)

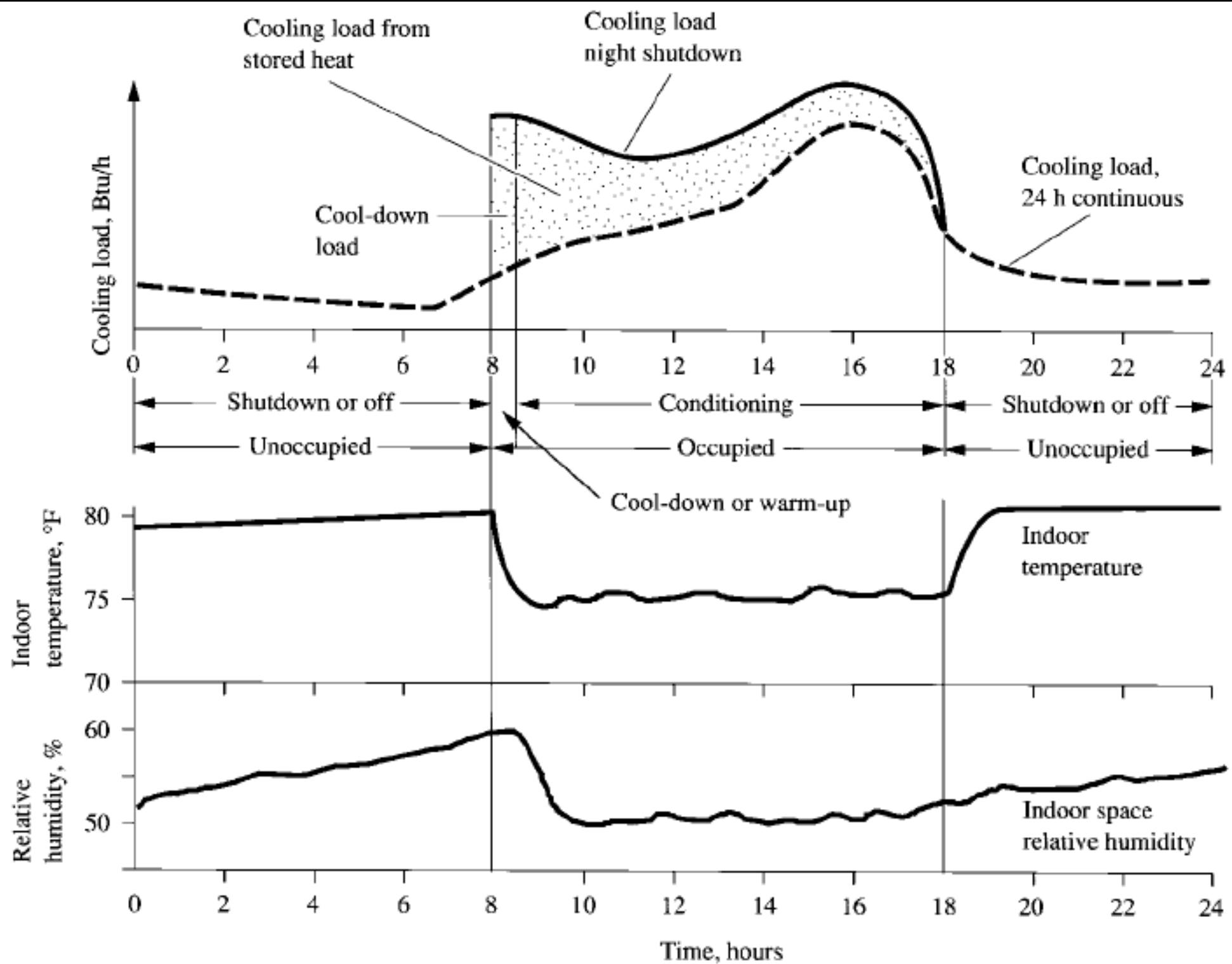

(Source: Wang, S. K., 2001. *Handbook of Air Conditioning and Refrigeration*, 2nd ed.)

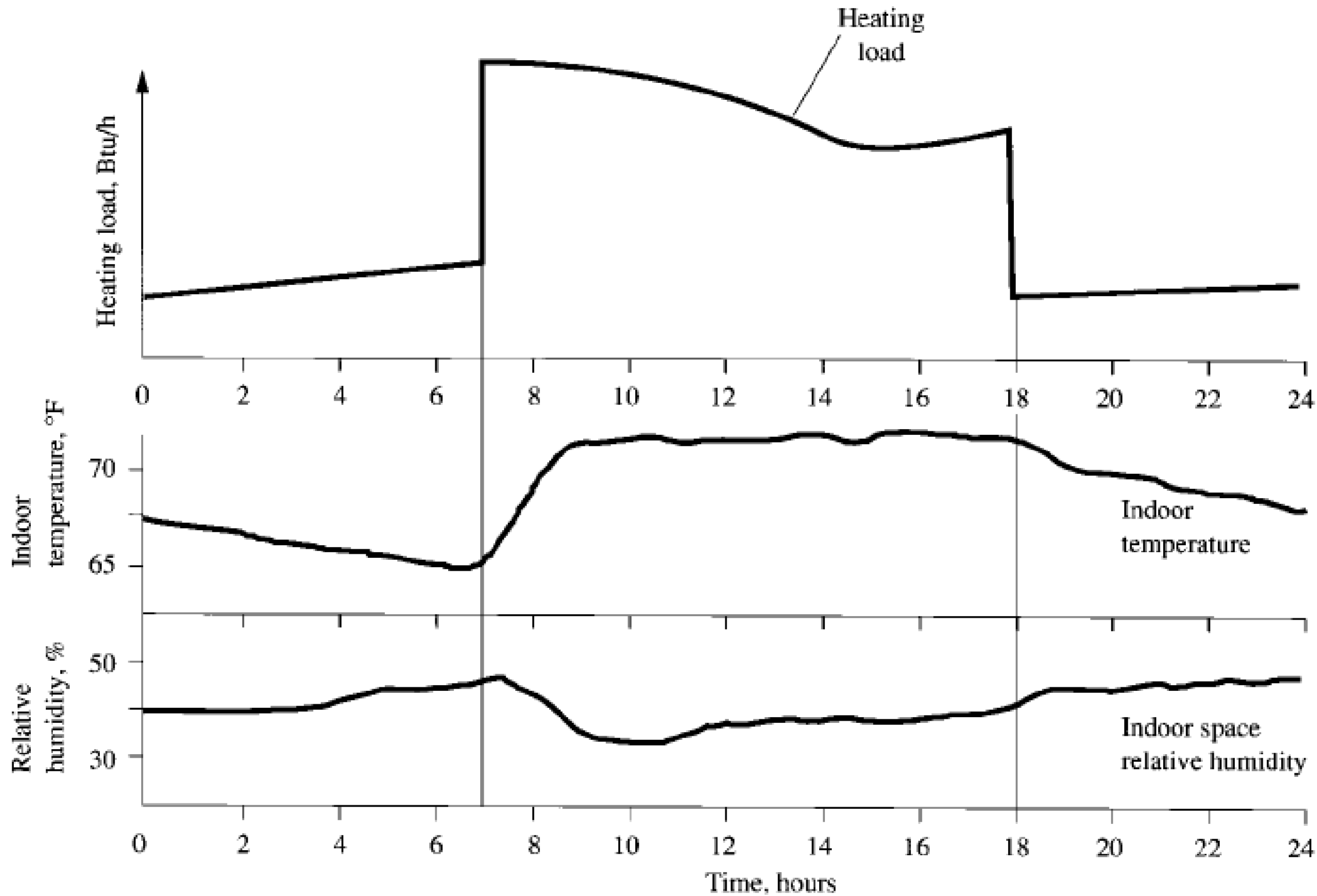

(Source: Wang, S. K., 2001. *Handbook of Air Conditioning and Refrigeration*, 2nd ed.)

# Cooling Load Principles

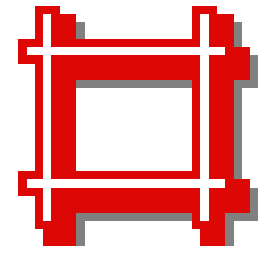

- Cooling load profiles
  - Shows the variation of space cooling load
  - Such as 24-hr cycle
  - Useful for building operation & energy analysis
  - What factors will affect load profiles?
- Peak load and block load
  - Peak load = max. cooling load
  - Block load = sum of zone loads at a specific time

# Cooling load profiles

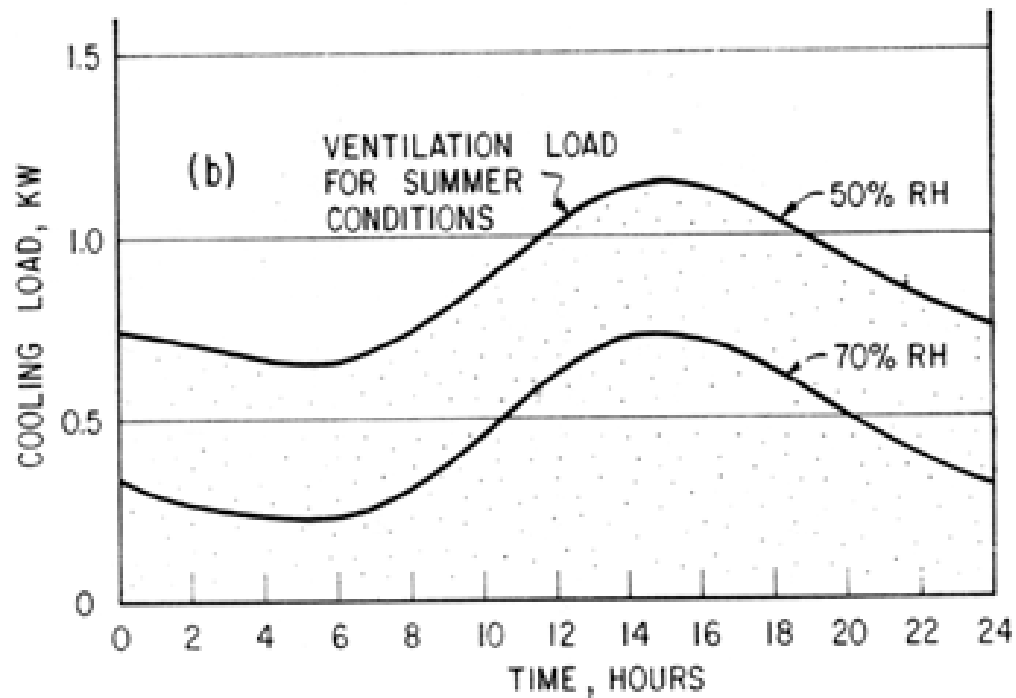
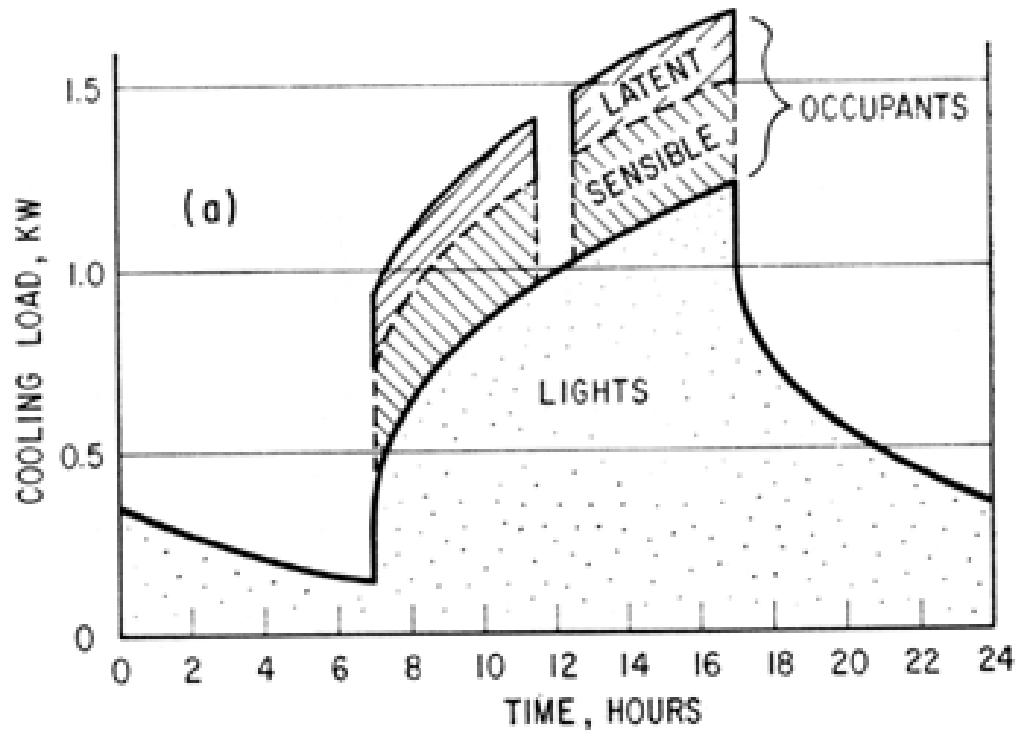

## Total cooling load

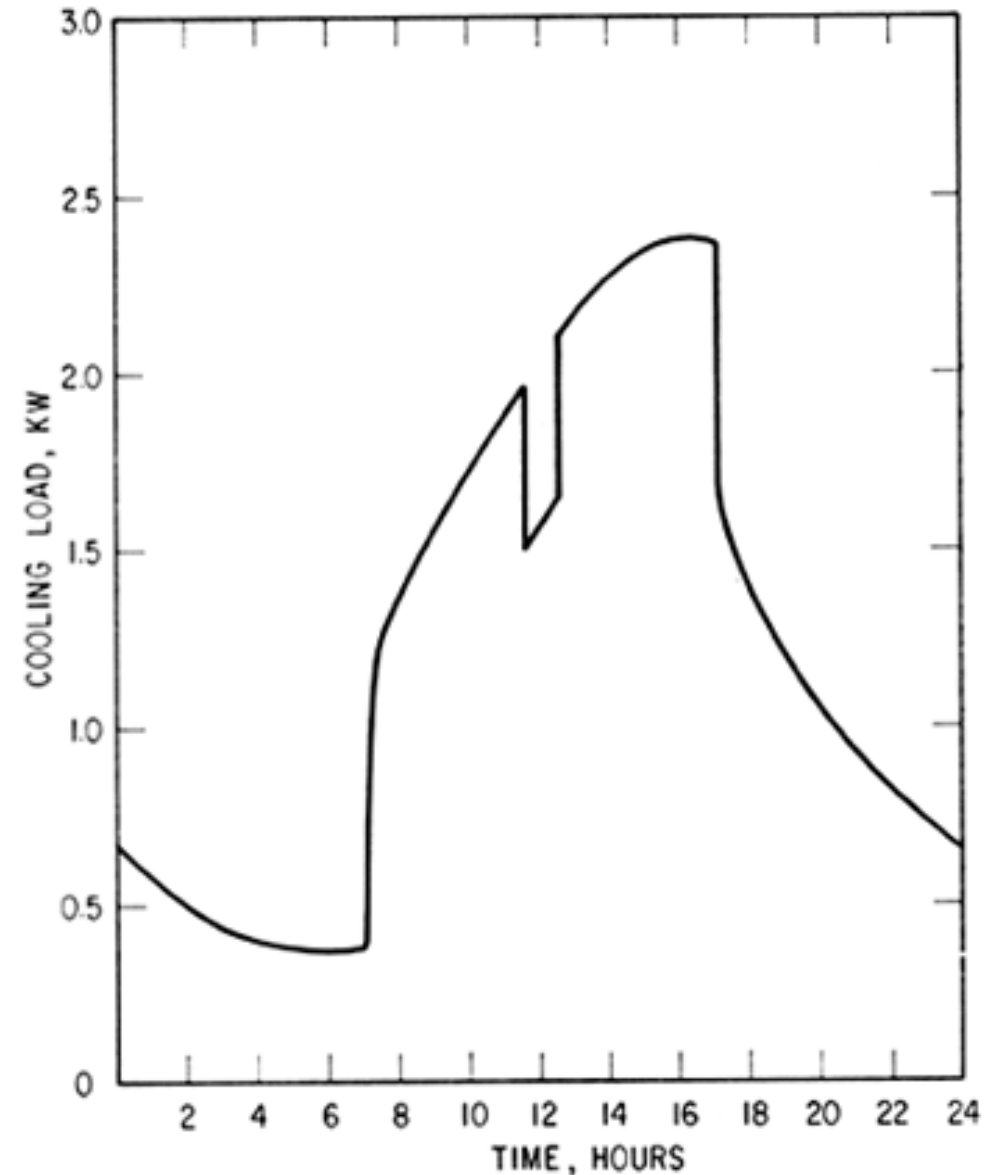

North

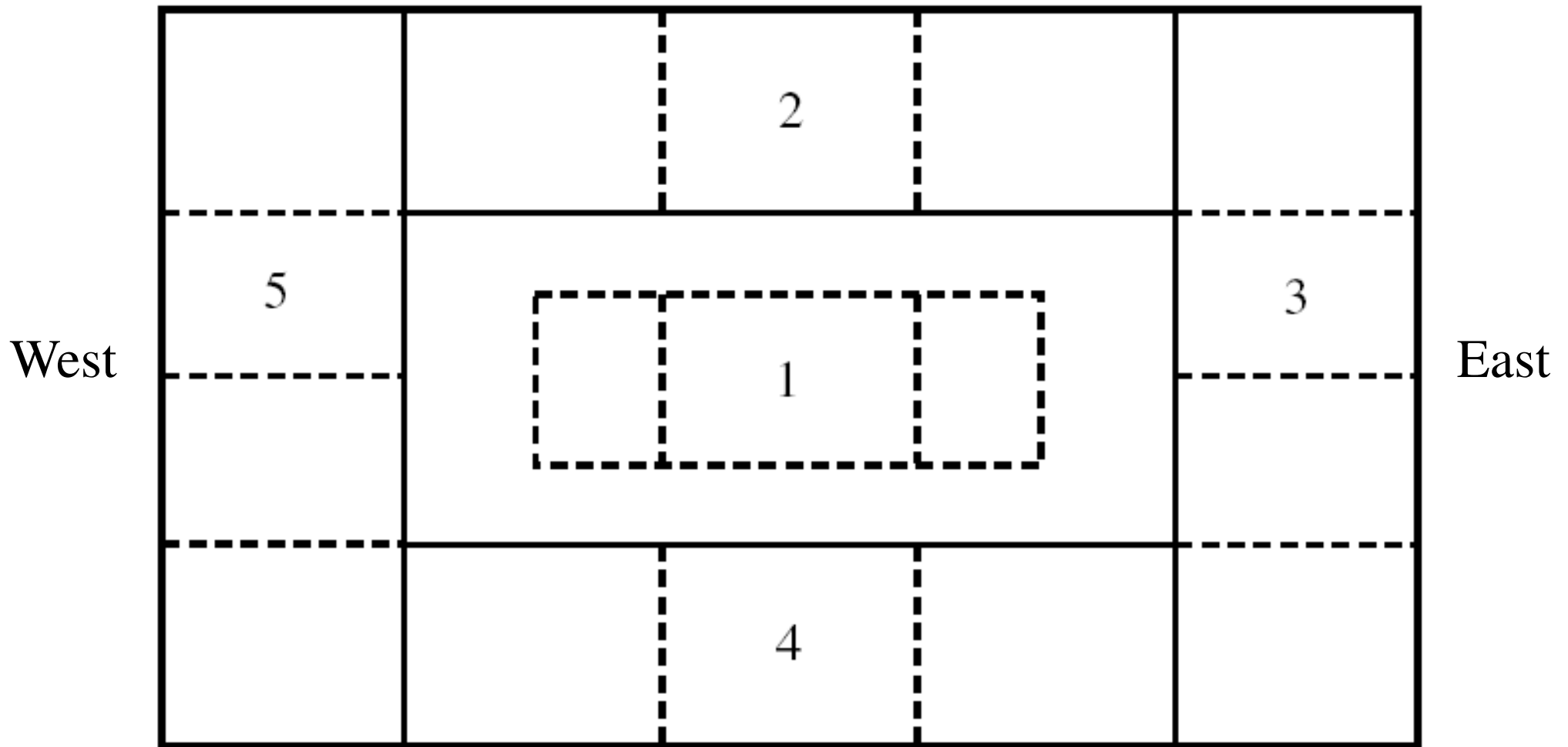

South

Block load and thermal zoning



# Profiles of solar heat gain (July) (for latitude 48 deg N)

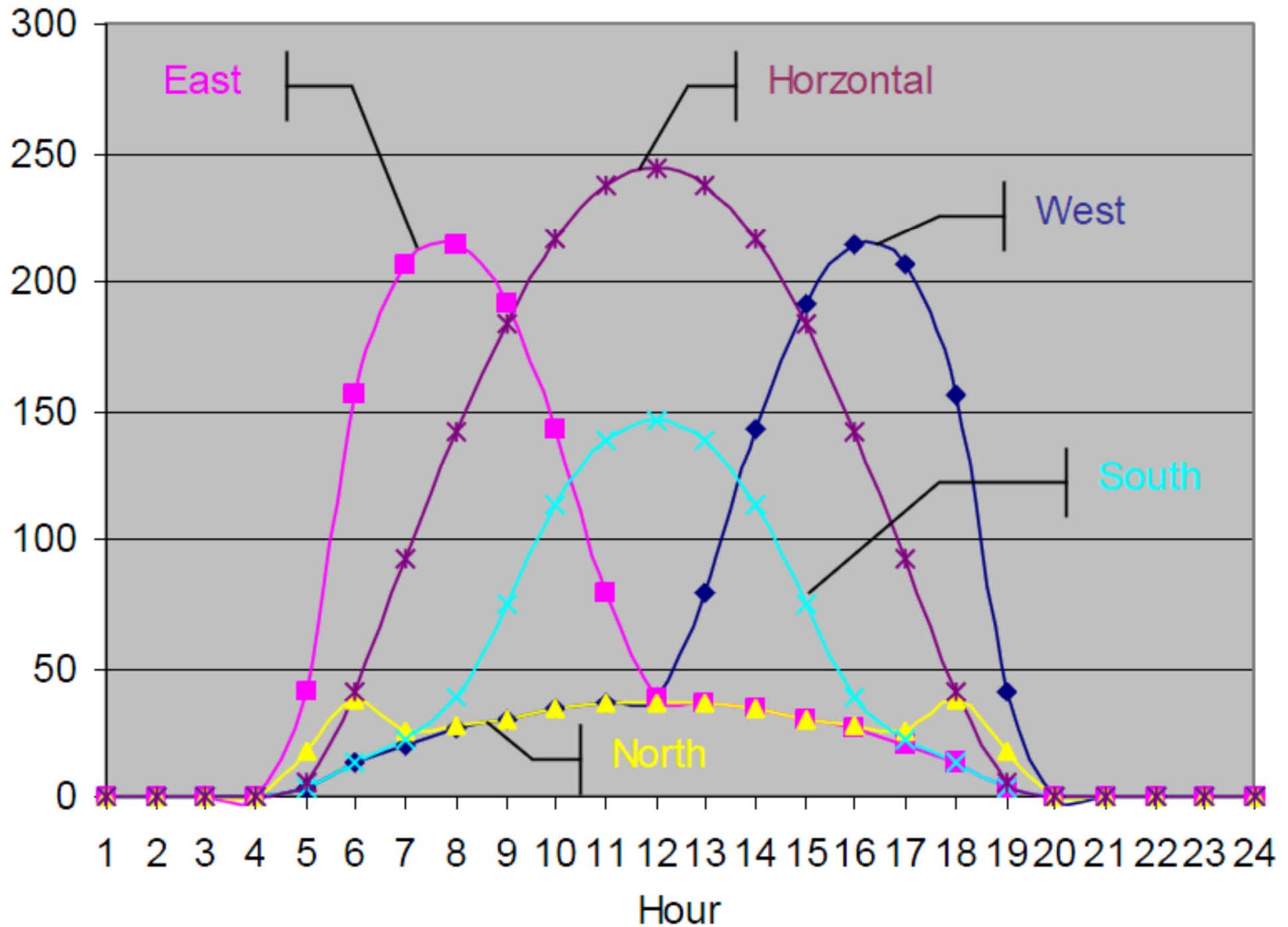

(Source: Keith E. Elder)

Solar cooling load vs. heat gain (July, west) (latitude 48 deg N)

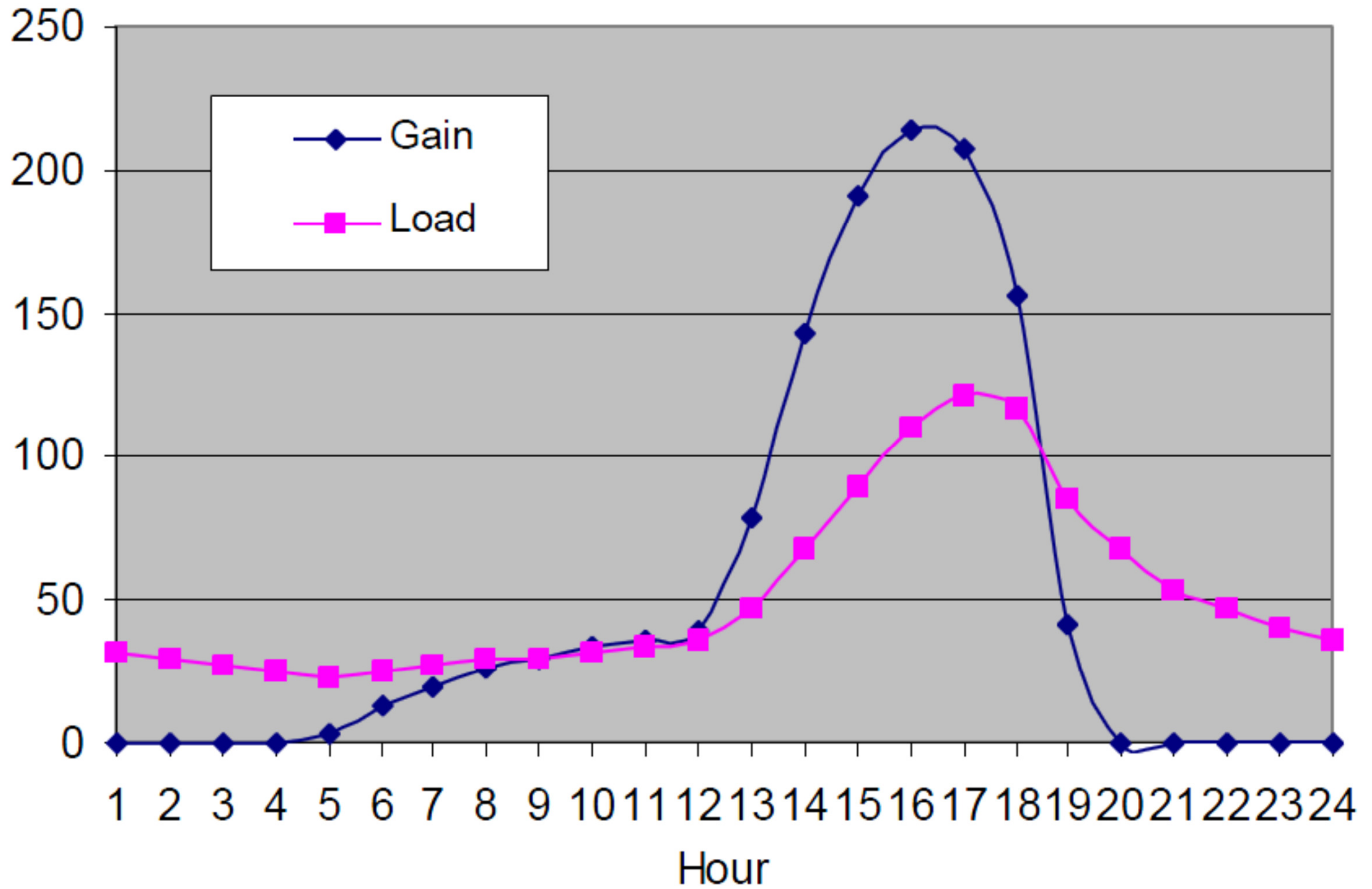

(Source: Keith E. Elder)

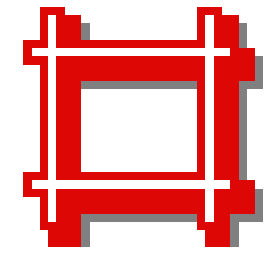

# Cooling Load Principles

- Moisture transfer
  - Two paths:
    - Moisture migrates in building envelope
    - Air leakage (infiltration or exfiltration)
  - If slight RH variation is acceptable, then storage effect of moisture can be ignored
    - Latent heat gain = latent cooling load (instantaneously)
- What happens if both temp. & RH need to be controlled?

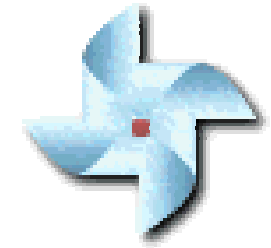

# Cooling Coil Load

- Cooling coil load consists of:
  - Space cooling load (sensible & latent)
  - Supply system heat gain (fan + air duct)
  - Return system heat gain (plenum + fan + air duct)
  - Load due to outdoor ventilation rates (or ventilation load)
- Do you know how to construct a summer air conditioning cycle on a psychrometric chart?
  - See also notes in Psychrometrics

# Typical summer air conditioning cycle

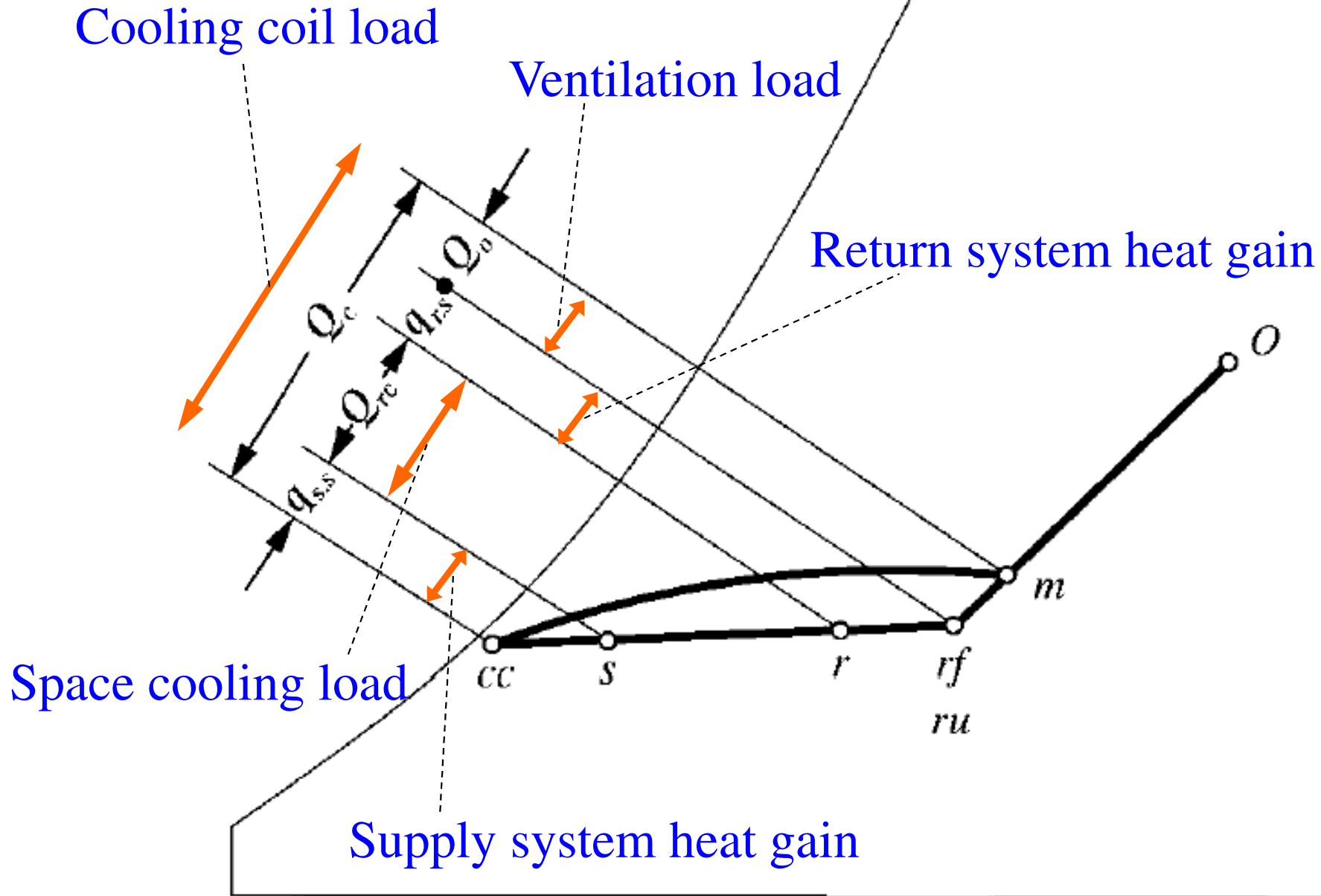

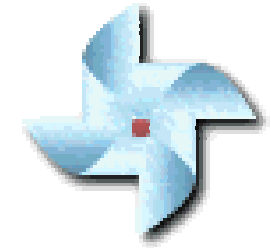

# Cooling Coil Load

- Space cooling load 
$$\text{Supply airflow (L/s)} = \frac{\text{Sensible load (kW)}}{1.2 \times \Delta t}$$
  - To determine supply air flow rate & size of air system, ducts, terminals, diffusers
  - It is a component of cooling coil load
  - Infiltration heat gain is an instant. cooling load
- Cooling coil load
  - To determine the size of cooling coil & refrigeration system
  - Remember, ventilation load is a coil load

# Heating Load



- Design heating load

- Max. heat energy required to maintain winter indoor design temp.
  - Usually occurs before sunrise on the coldest days
  - Include transmission losses & infiltration/ventilation
- Assumptions:
  - All heating losses are instantaneous heating loads
  - Credit for solar & internal heat gains is not included
  - Latent heat often not considered (unless w/ humidifier)
  - Thermal storage effect of building structure is ignored

# Heat losses for heating load calculation

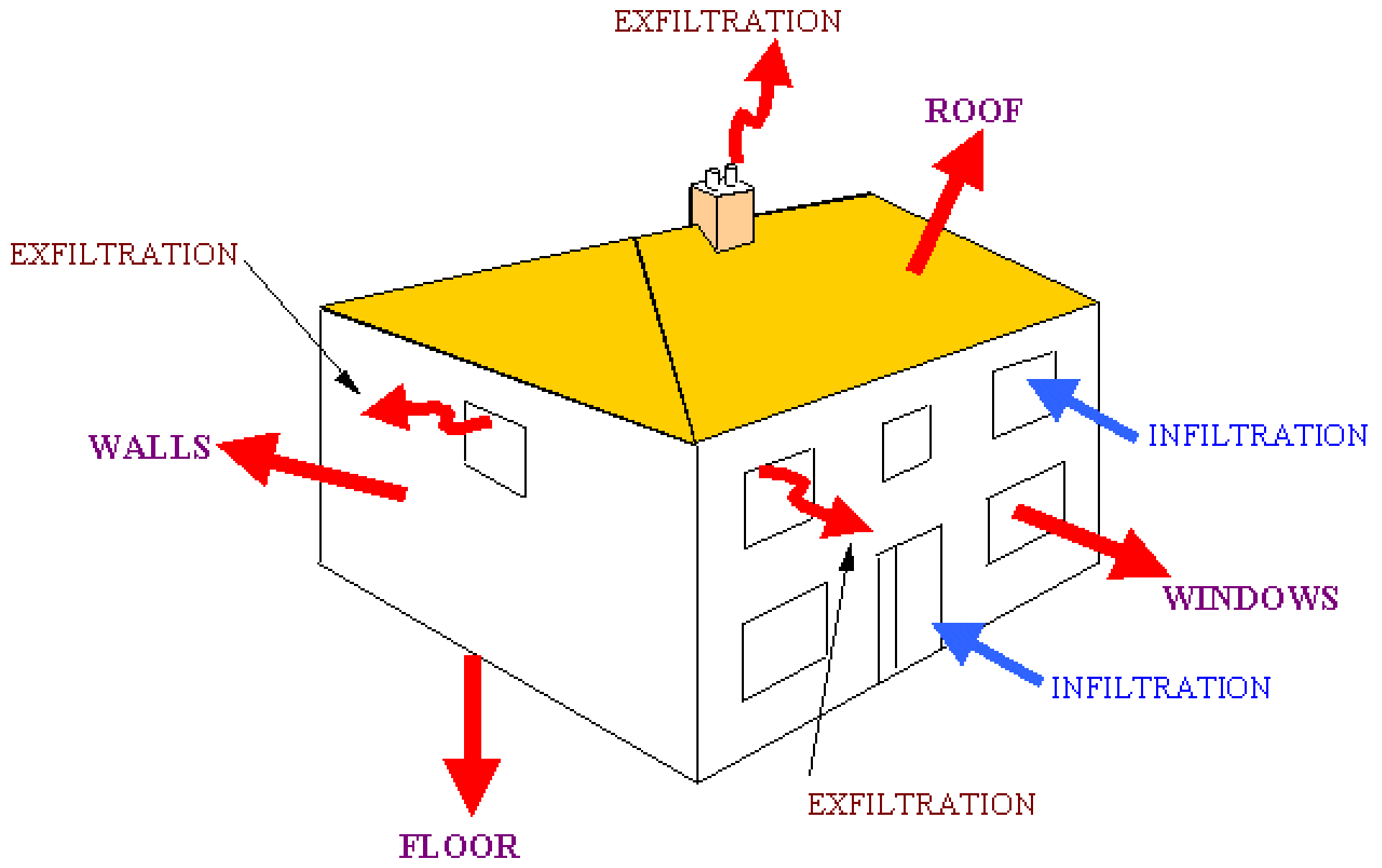

HEAT LOSS FROM A HOUSE



# Heating Load



- A simplified approach to evaluate worst-case conditions based on
  - Design interior and exterior conditions
  - Including infiltration and/or ventilation
  - No solar effect (at night or on cloudy winter days)
  - Before the presence of people, light, and appliances has an offsetting effect
- Also, a warm-up/safety allowance of 20-25% is fairly common

**Table 12 Summary of Loads, Equations, and References for Calculating Design Heating Loads**

Heating Load	Equation	Reference, Table, Description
Roofs, ceilings, walls, glass	$q = U A \Delta t$	<p>Chapter 24, Tables 1, 2, and 4</p> <p>Temperature difference between inside and outside design dry bulbs, Chapter 26. For temperatures in unheated spaces, see Equation (2); for attic temperatures, see Equation (3).</p> <p>Area calculated from plans</p>
Walls below grade	$q = U A \Delta t$	<p>See Table 14.</p> <p>Use Figure 6 to assist in determining <math>\Delta t</math>.</p>
Floors		
Above grade	$q = U A \Delta t$	<p>For crawl space temperatures, see Equation (4).</p>
On grade	$q = F_2 P \Delta t$	<p>See Table 16.</p> <p>See Equation (6).</p> <p>Perimeter of slab</p>
Below grade	$q = U A \Delta t$	<p>Use Figure 6 to assist in determining <math>\Delta t</math>.</p> <p>See Table 15.</p>
Infiltration and ventilation air		
Sensible	$q_s = 0.018 Q \Delta t$	<p>Volume of outdoor air entering building. See Chapter 25 for estimating methods for infiltration.</p>
Latent	$q_t = 80.7 Q \Delta W$	<p>Humidity ratio difference, if humidification is to be added</p>

# Software Applications

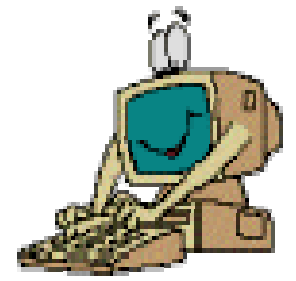

- Examples of load calculation software:
  - Carmel Loadsoft 6.0 [AV 697.00028553 L79]\*
    - Commercial and industrial HVAC load calculation software based on ASHRAE 2001 Fundamentals radiant time series (RTS) method
  - Carmel Residential 5.0 [AV 697.00028553 R43]\*
    - Residential and light commercial HVAC load calculation software based on ASHRAE 2001 Fundamentals residential algorithms

(\* Can be found in the HKU Library.)

# Software Applications

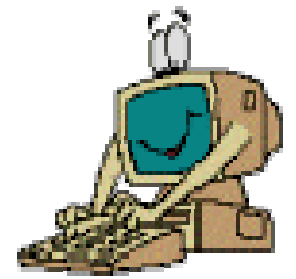

- Examples of load/energy calculation software:
  - TRACE 700
    - TRACE = Trane Air Conditioning Economics
    - Commercial programs from Trane
      - <http://www.trane.com/commercial/>
    - Most widely used by engineers in USA
    - Building load and energy analysis software
  - Carrier E20-II HAP (hourly analysis program)
    - <http://www.carrier-commercial.com/>