

SBS5322 Basics of Building Information Modelling

<http://ibse.hk/SBS5322/>



Construction coordination



Ir. Dr. Sam C. M. Hui

Faculty of Science and Technology

E-mail: cmhui@vtc.edu.hk

Jan 2018

Contents



- Construction planning
- Virtual construction model
- Potential benefits
- BIM-based coordination
- Examples of coordination issues

Problem Definition

- **Design**
 - No direct cost feedback on design decisions
 - Coordination of trades
- **Sub Contractor Cost**
 - Missing / Incorrect Design Information
 - Inability for reusing data for shop drawings
 - Field rework required for prefabricated components
 - Padding to compensate risks
 - Poor subcontractor work flow – “Starts and Stops”
 - Inadequate quantity information for planning
- **Construction**
 - Lack of owner trust – difficulties in communicating cost and schedule issues
 - Production control is based on subjective information
 - Frequent starts and stops
 - Estimating is time consuming and occasionally inaccurate
- **Facility Management**
 - Insufficient as-built project documentation
 - Renovation, addition and demolition planning is time consuming

Objectives

- **Winning the bid**
 - Fast design feedback loop
 - Fast & accurate estimates
 - Value engineering
 - Constructability analysis

- **Managing the 4 Ms**
 - Money
 - Manpower
 - Machinery
 - Materials

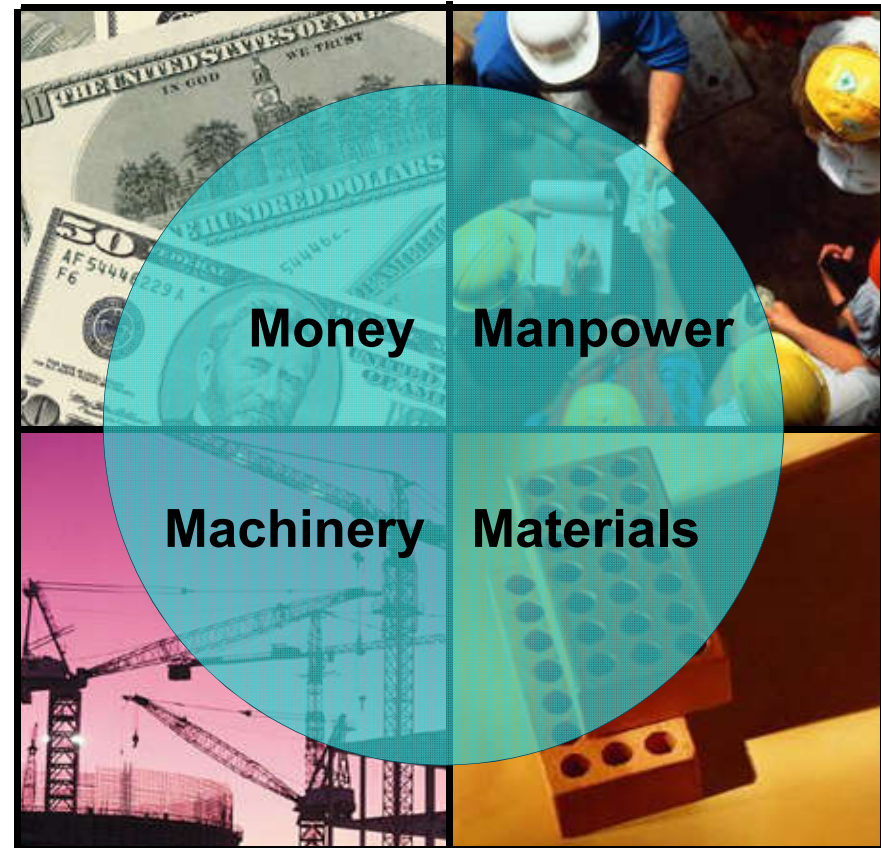

Construction Planing

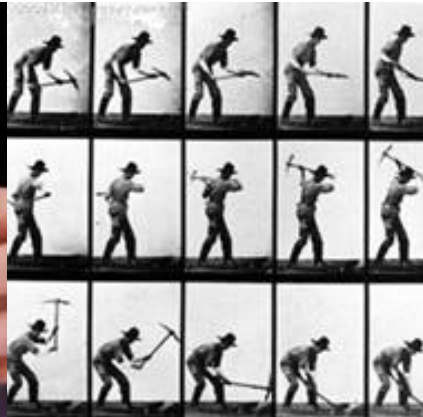
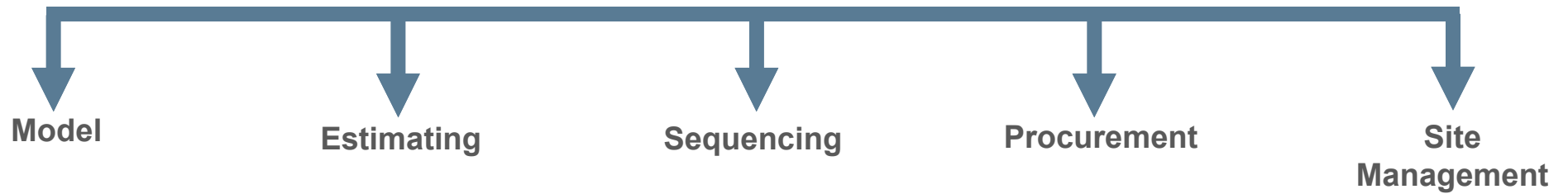

- Constructability Analysis
- Drives Estimating
- Provides Locations
- Zone Planning
- Design to Build / Build to Design

- Fast & Accurate
- Easy Updates – Linked
- Drives Sequencing

- Schedule Analysis
- Line of Balance
- Integrated Monte Carlo
- 4D Simulation
- Drives Procurement

- Data Mining for Supplier Negotiations
- Tracking of High Risk, Long Lead Items
- Integrated with the Project Schedule
- Drives Site Management Process

- Short Lead Procurement
- Site Planning for Materials, Equipment & Locations

Traditional Design Process

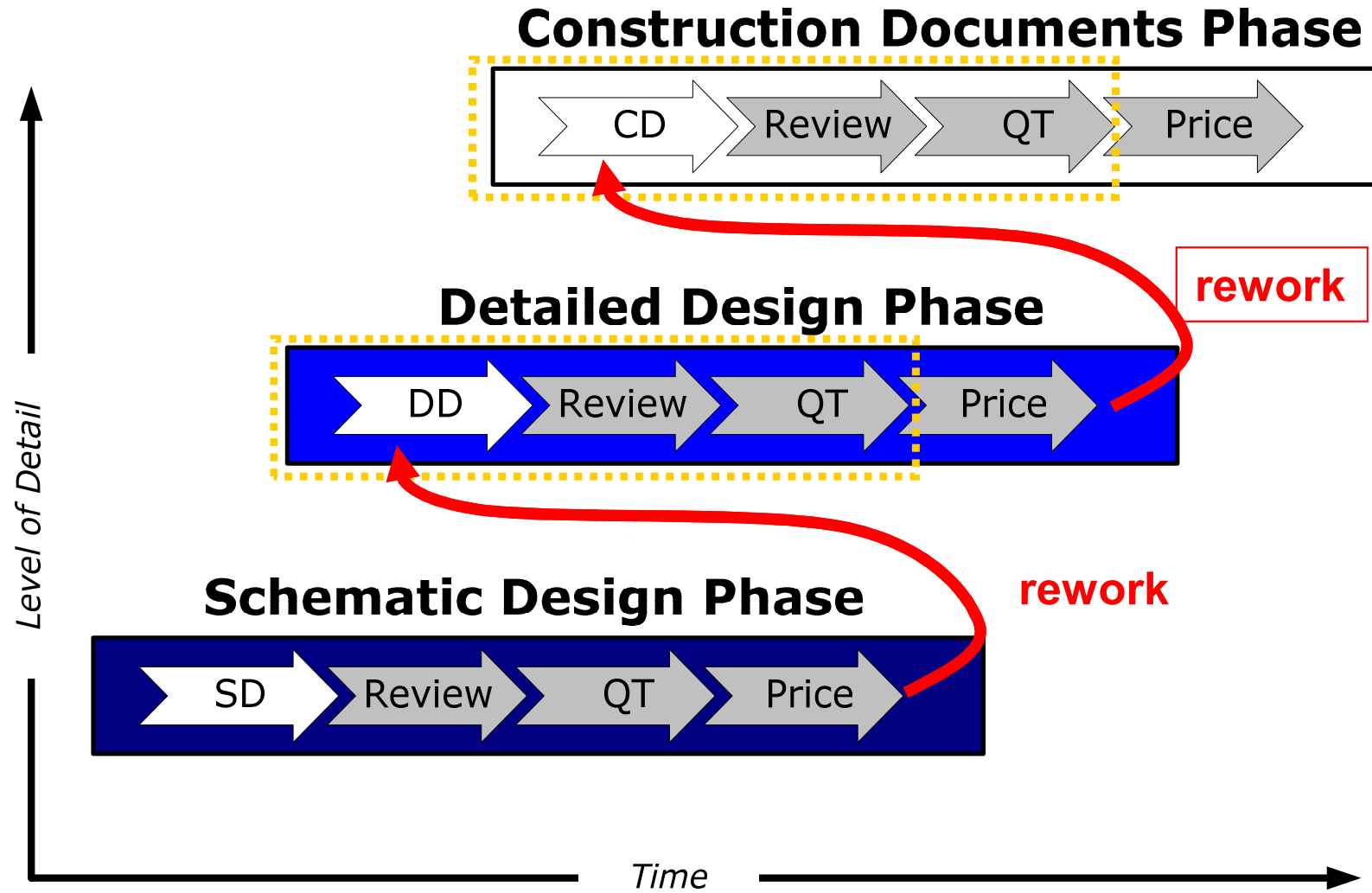

New Design Process

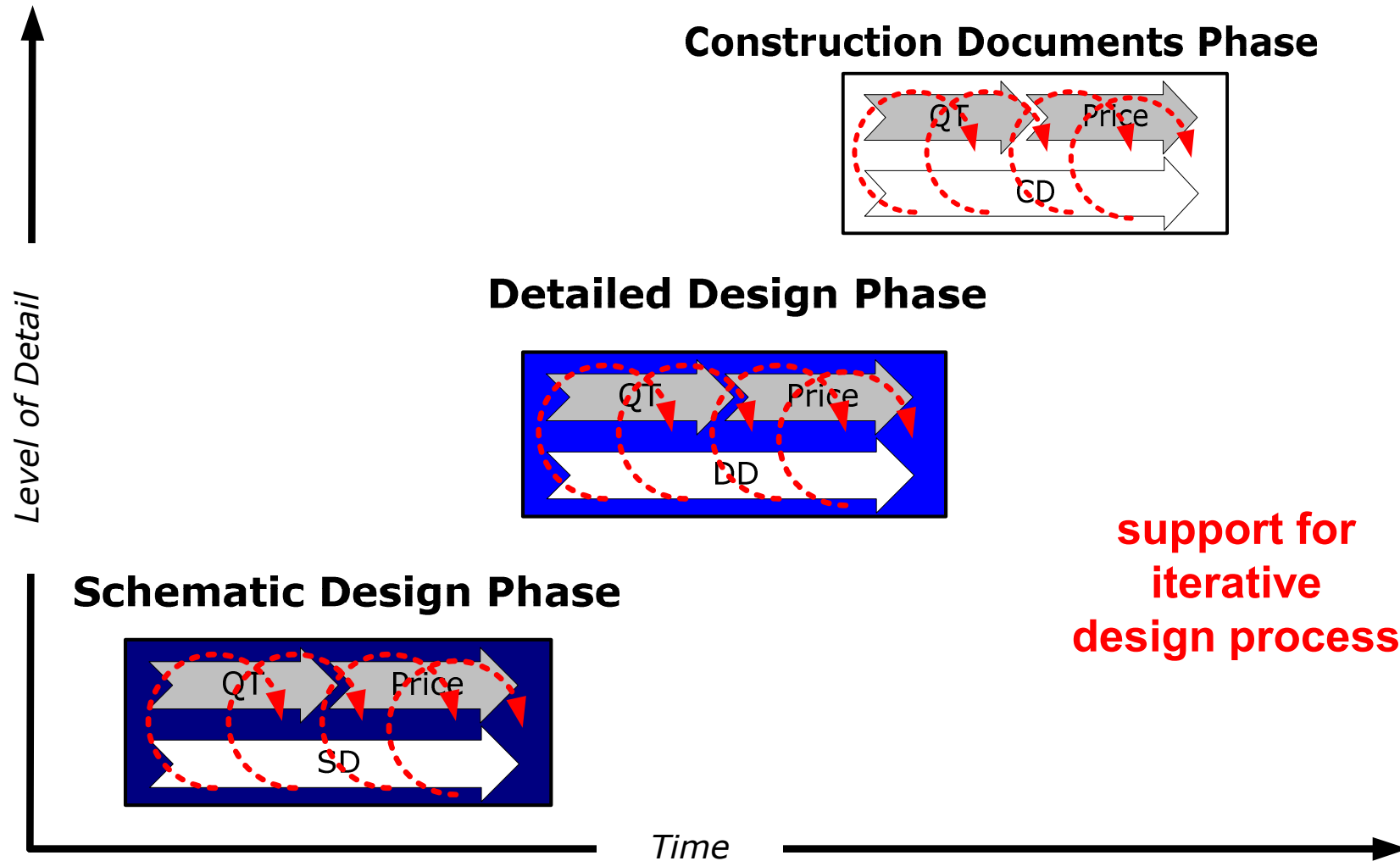

The Virtual Construction Model (5D)

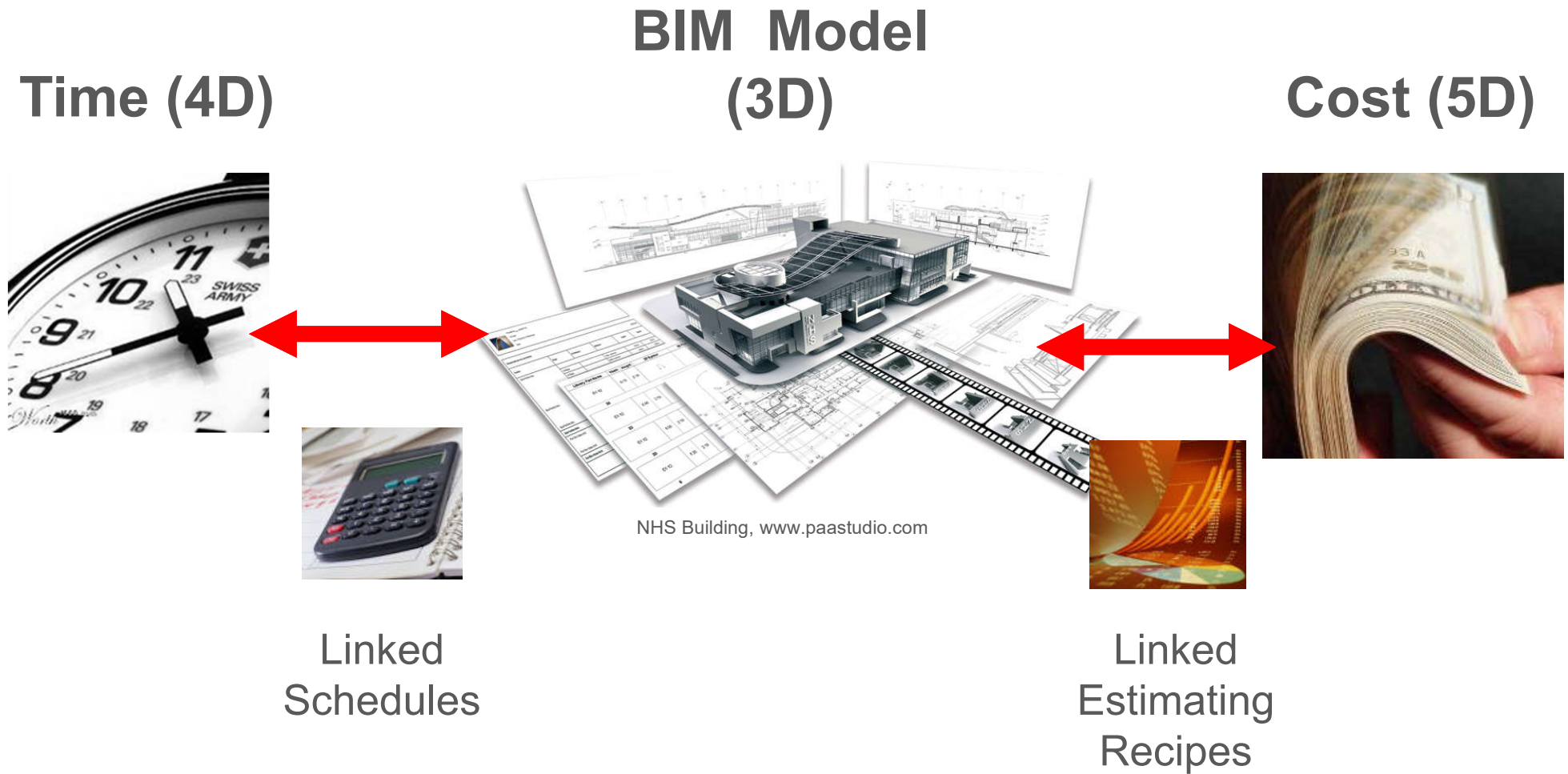

Work Flow

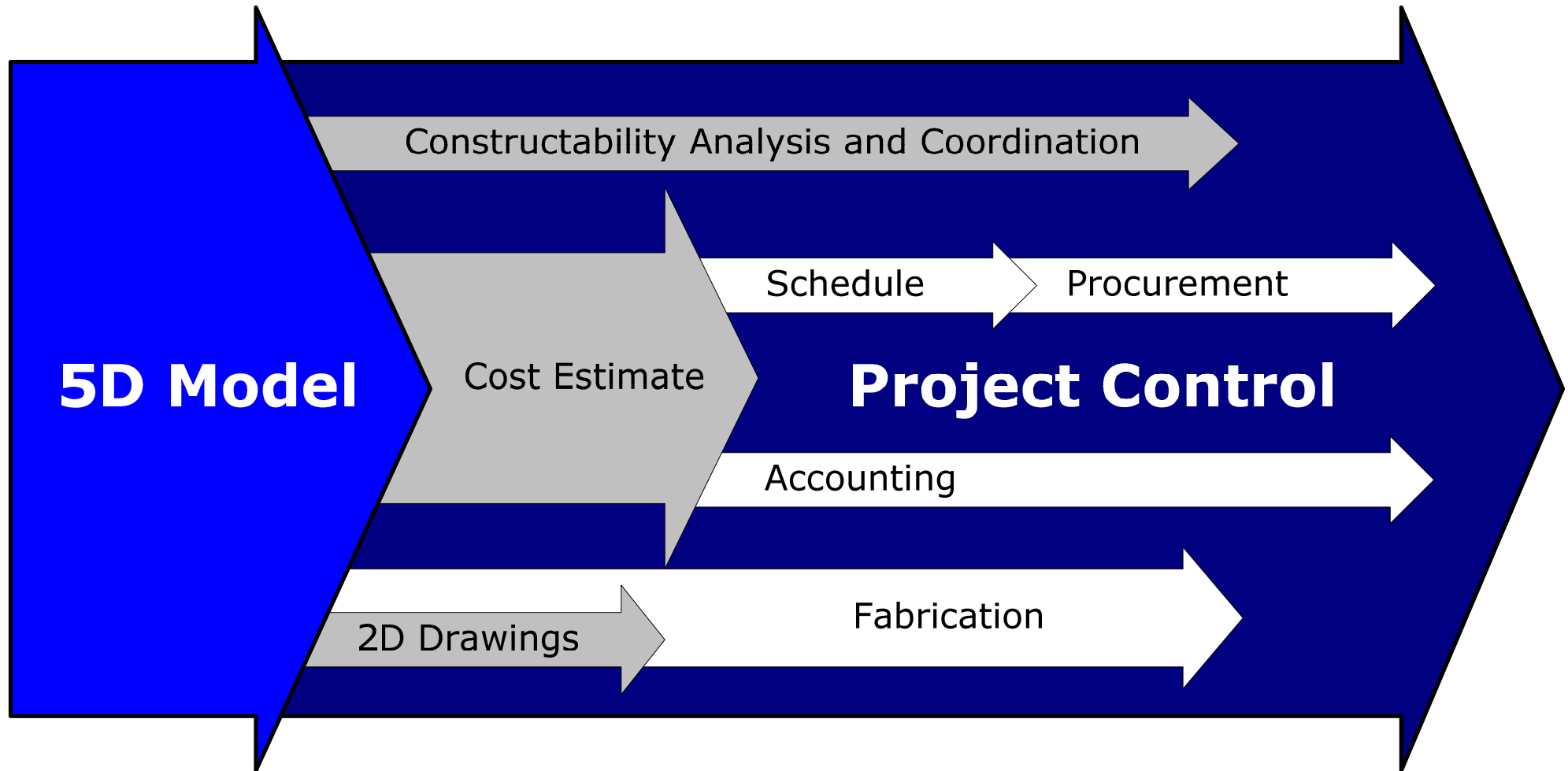

Construction Modelling

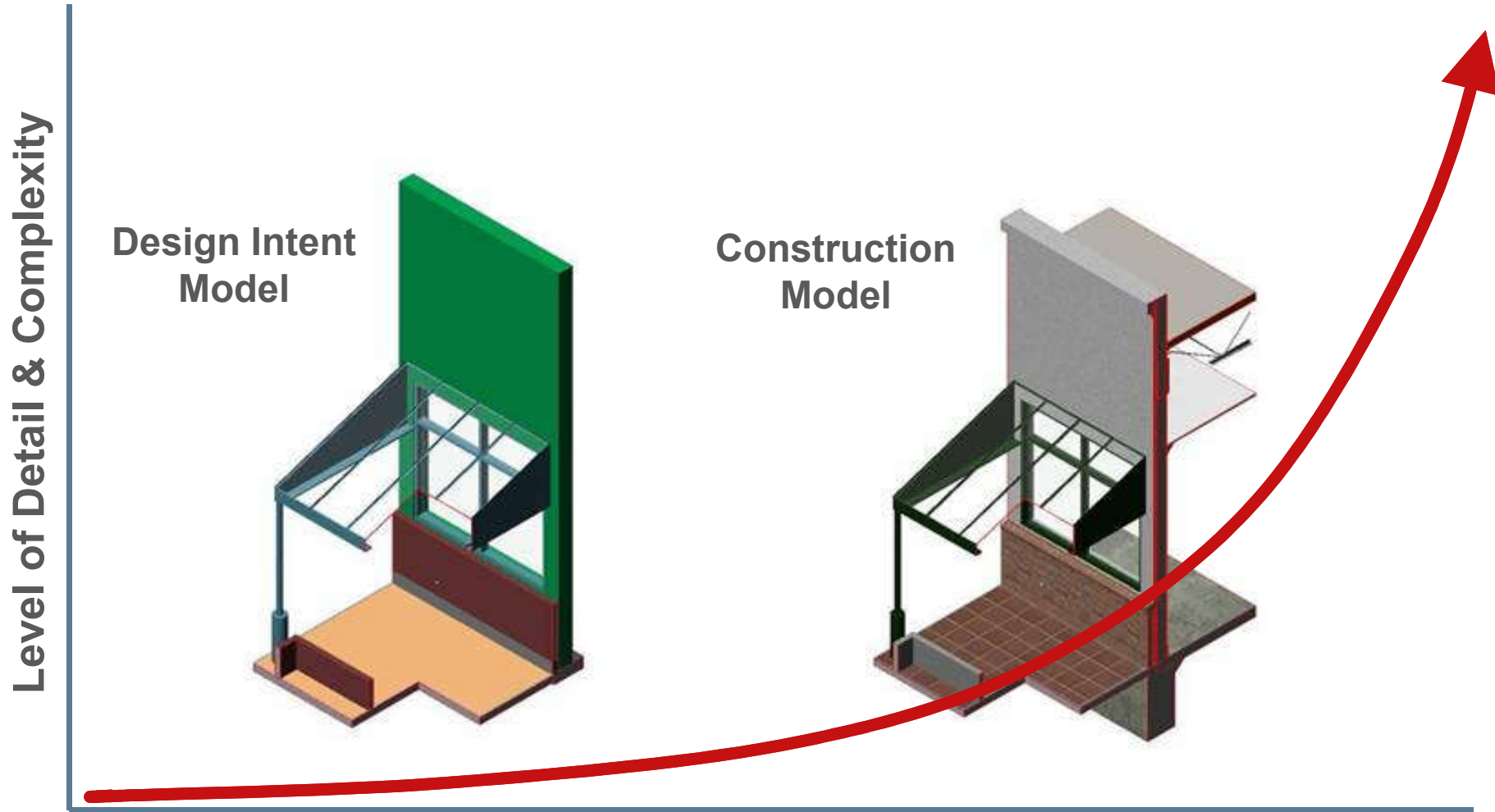

Construction Modelling

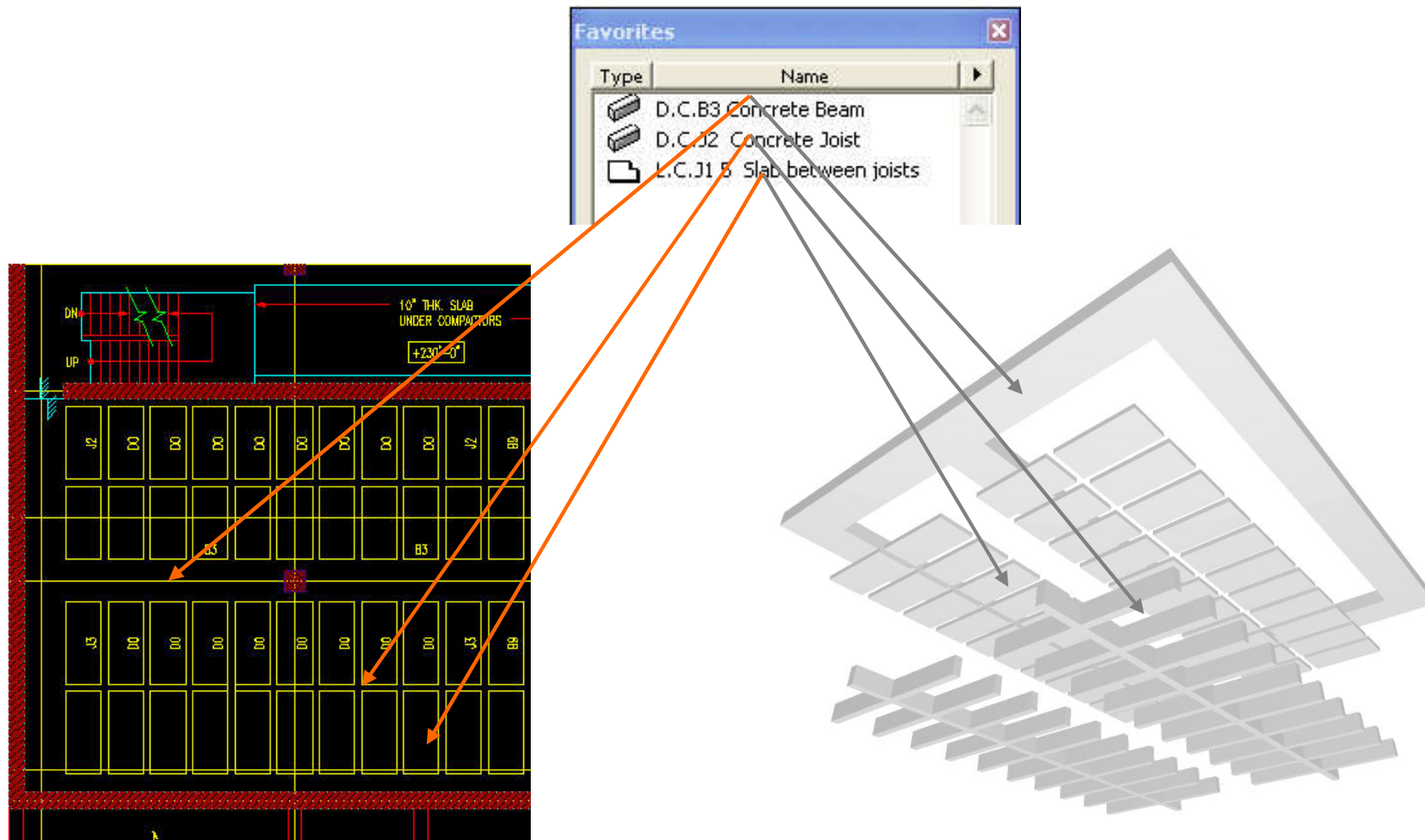

Recipe

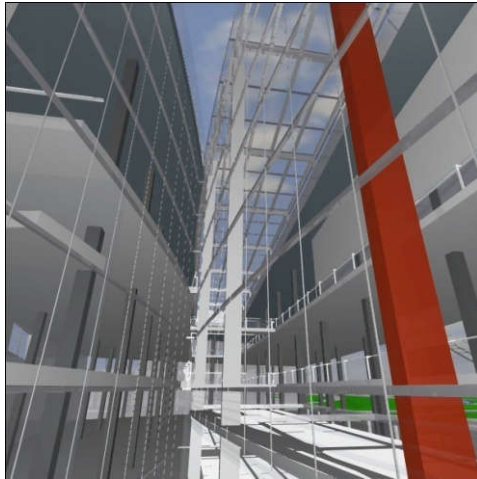

Recipe

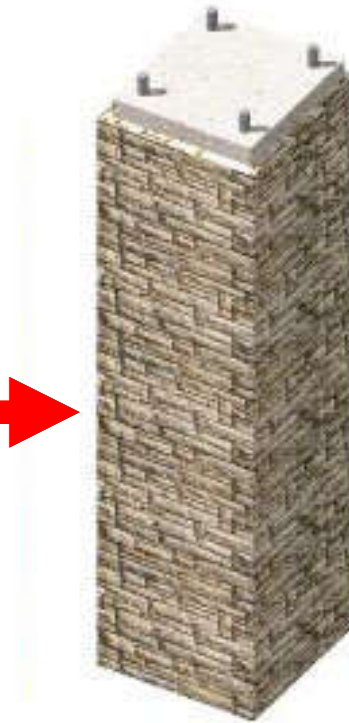

**Completed
Column**

Methods

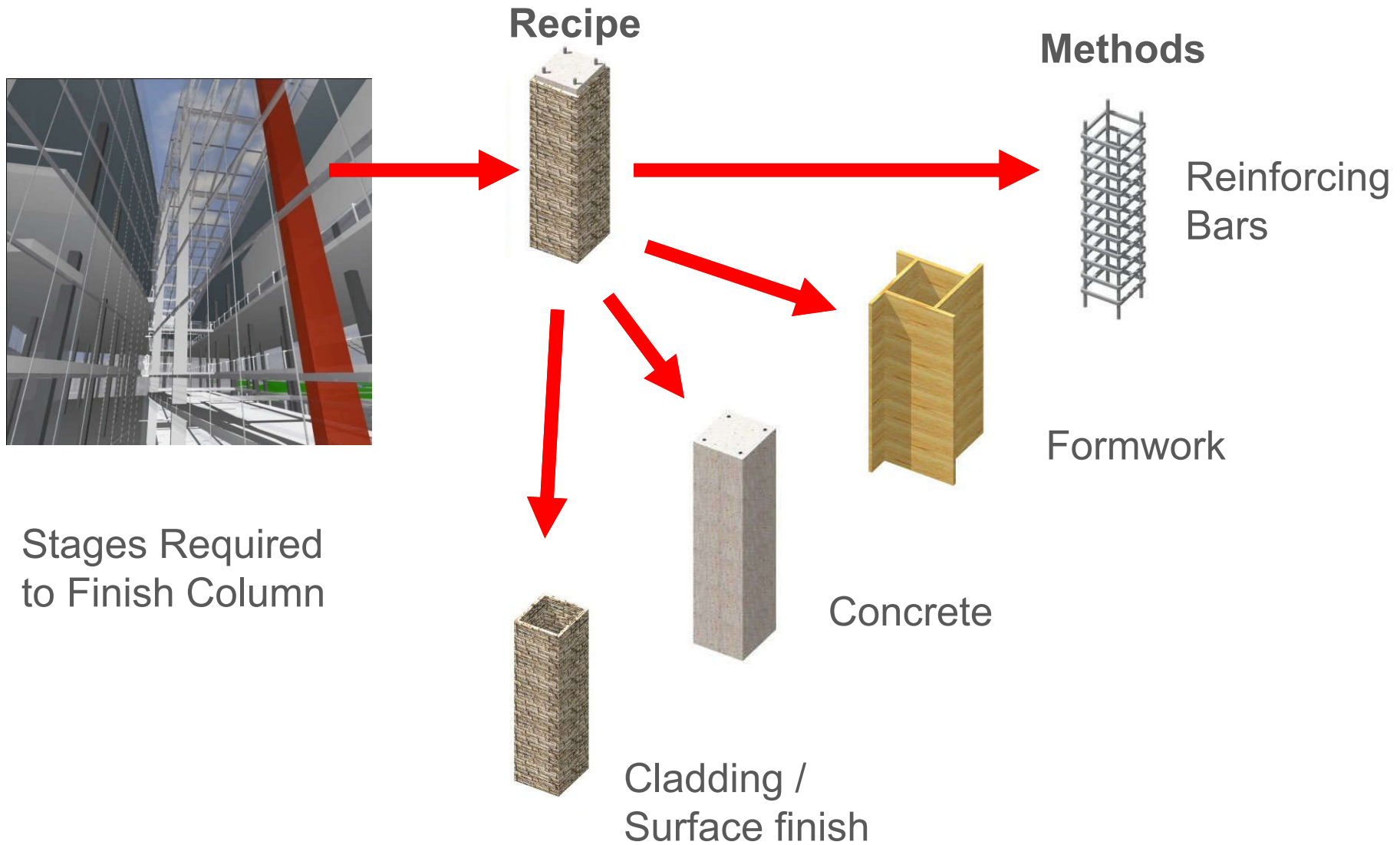

Resources

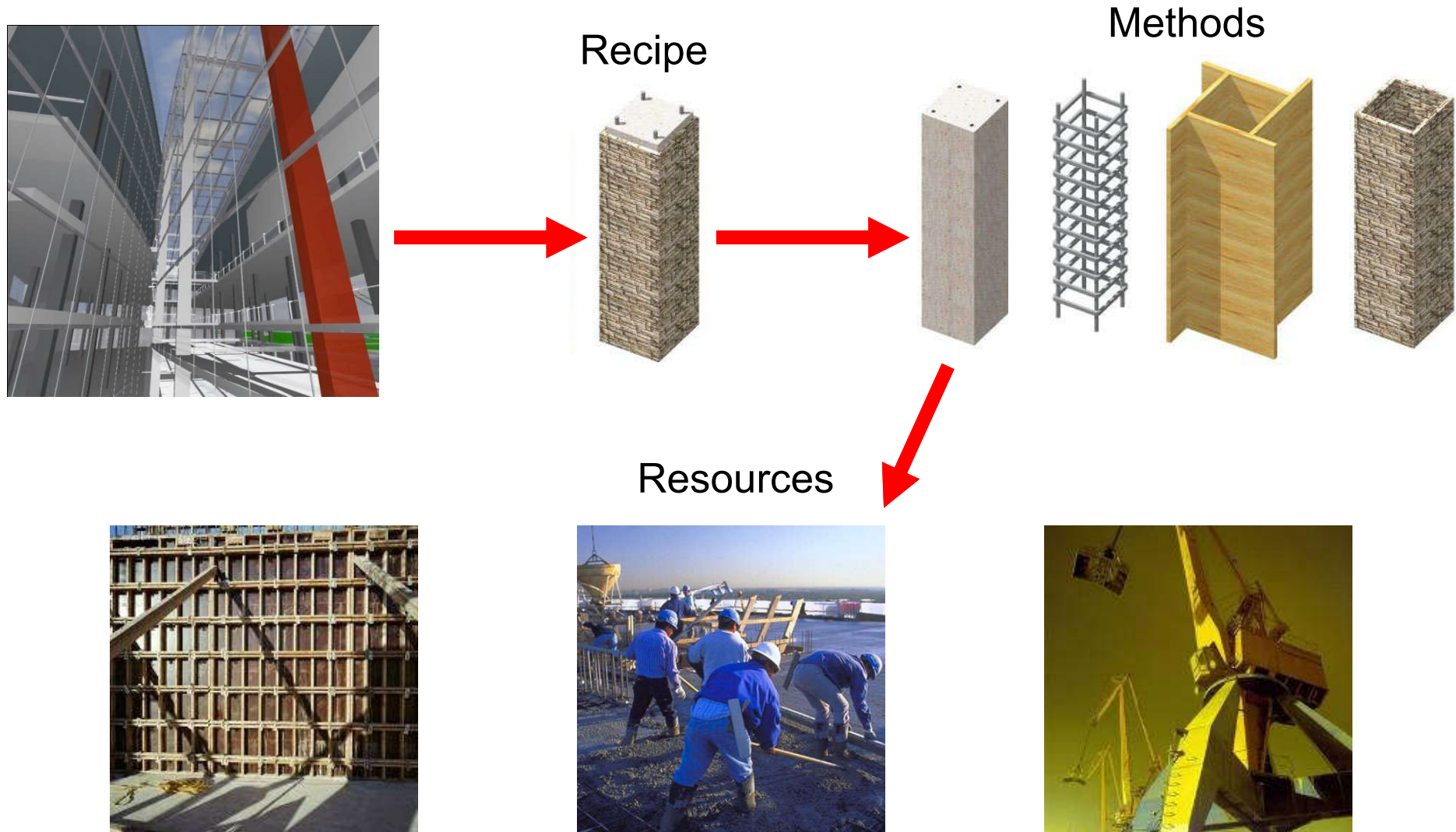

5D

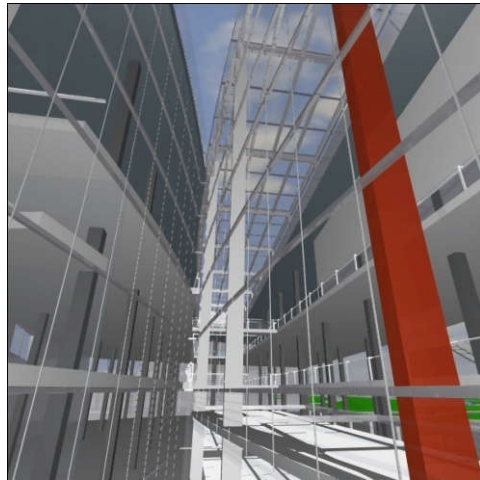

Recipe

Methods

Resources



Zones/Floors

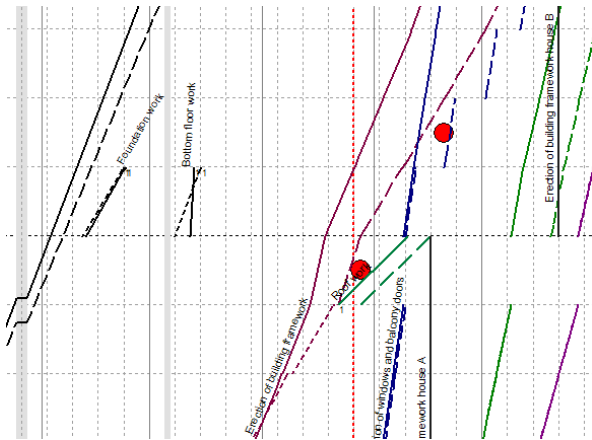

=

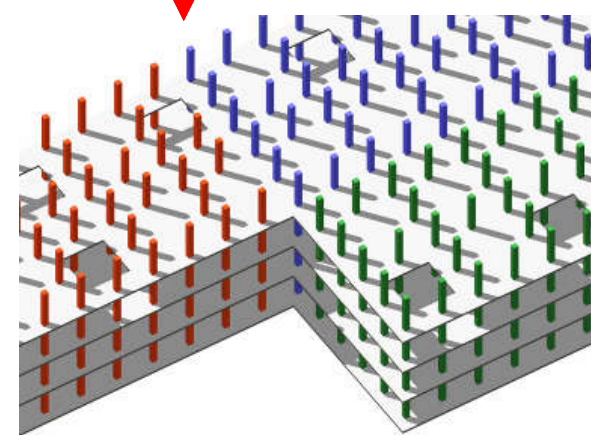

Benefits: Clash Detection

- Conventional methods of coordination are extremely time consuming and error-prone.
- Using internal or external clash detection software helps to identify the construction errors in the BIM model
- Construction risks and costs can be reduced significantly

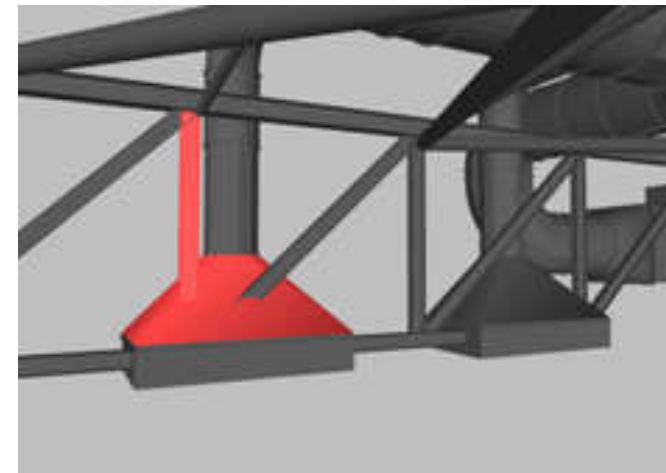
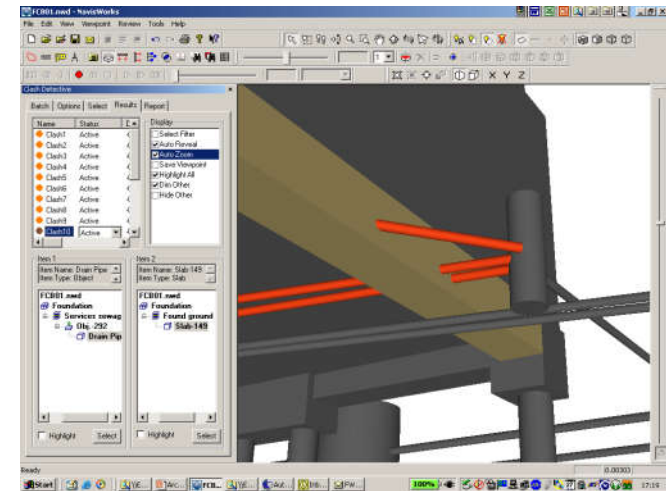

(See also: Coordination and Clash Detection <http://www.vicosoftware.com/coordination-and-clash-detection>)

(Source: Graphisoft BIM Curriculum <http://www.graphisoft.com/learning/bim-curriculum/>)

Benefits: Model-based Estimating

Early Design phases:

- Which materials?
- Price of materials?

Solution:

- Calculate cost ranges instead of fixed prices

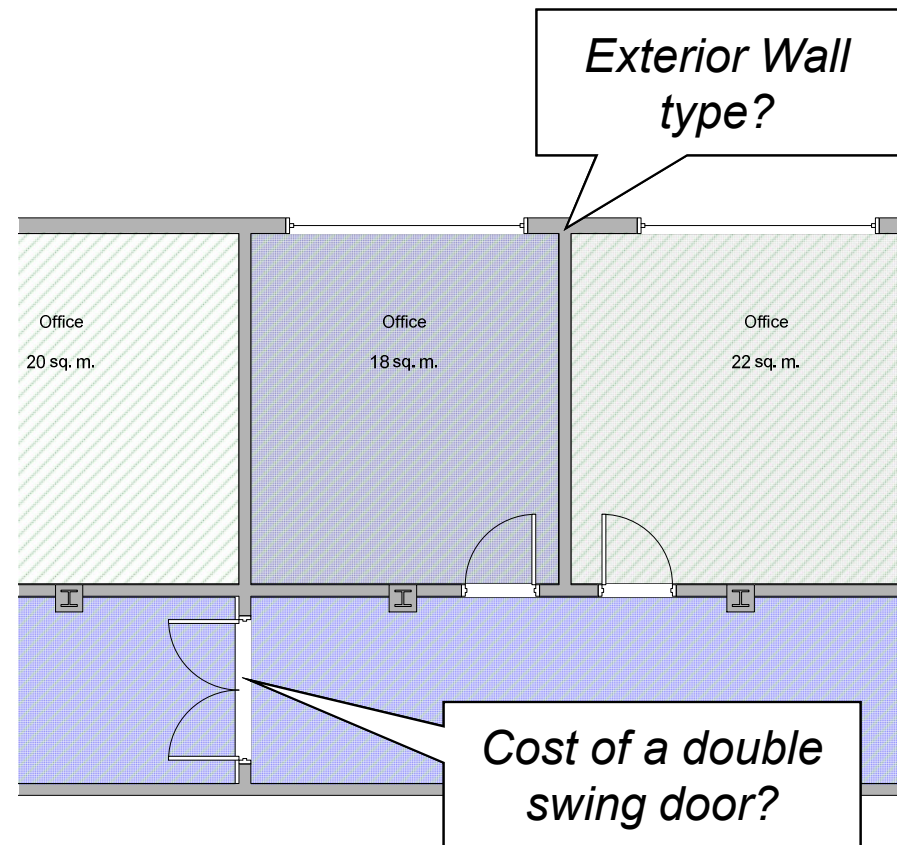

(See also: Model-Based Estimating <http://www.vicosoftware.com/model-based-estimating>)

(Source: Graphisoft BIM Curriculum <http://www.graphisoft.com/learning/bim-curriculum/>)

Benefits: Design to Build

Design follows construction methodology:

- Acceptable Tolerance
- Coordination of Trades
- Quality Check

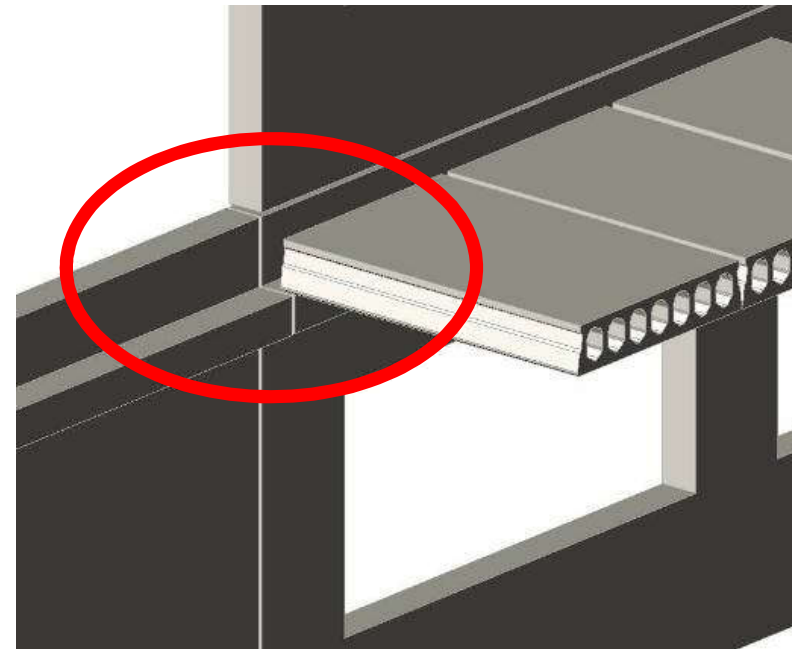
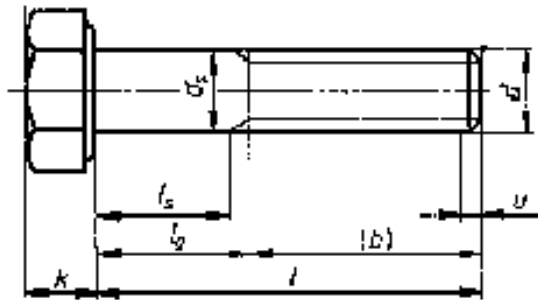

Benefits: Build to Design

- Measure points
- Check Onsite
- Guarantee Fit

X, Y, Z

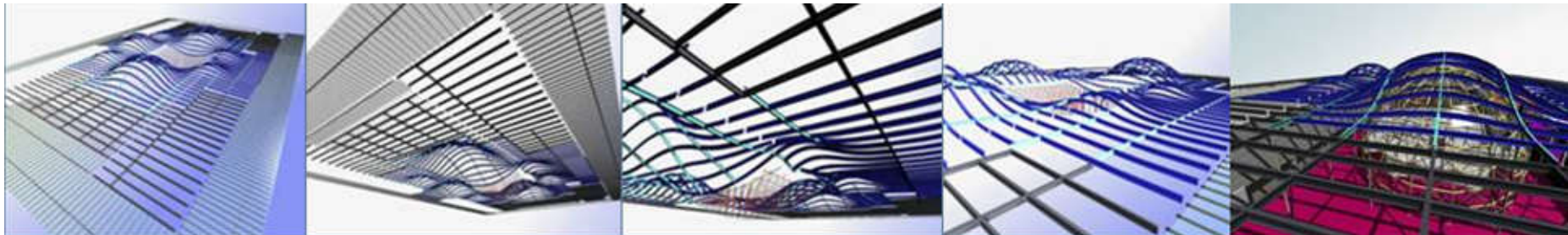
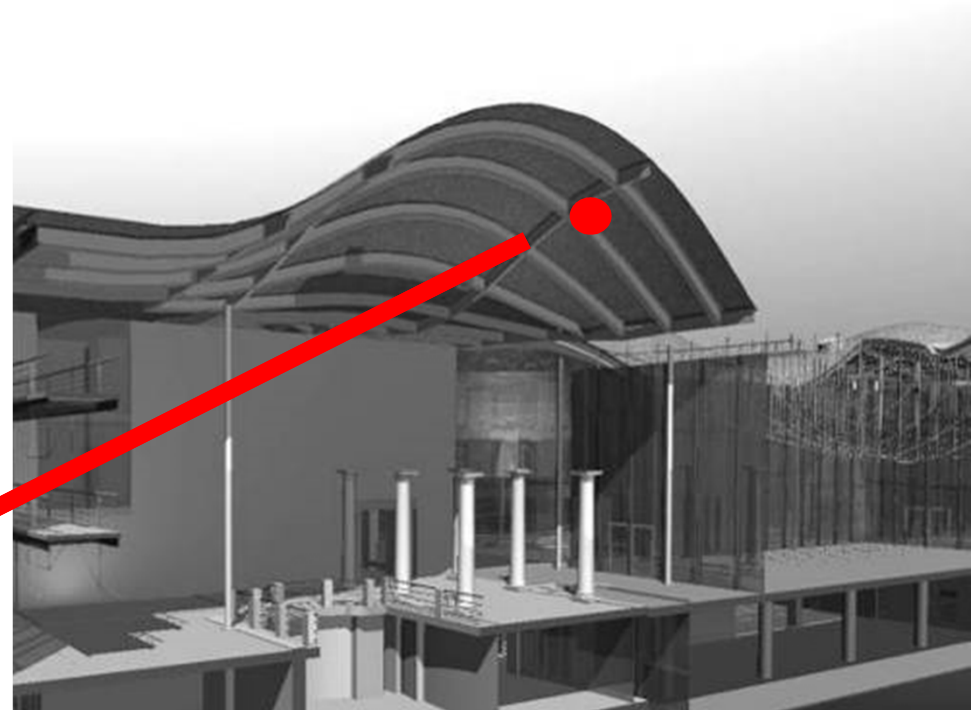

Schematic BIM-based creation, coordination, and collaboration process

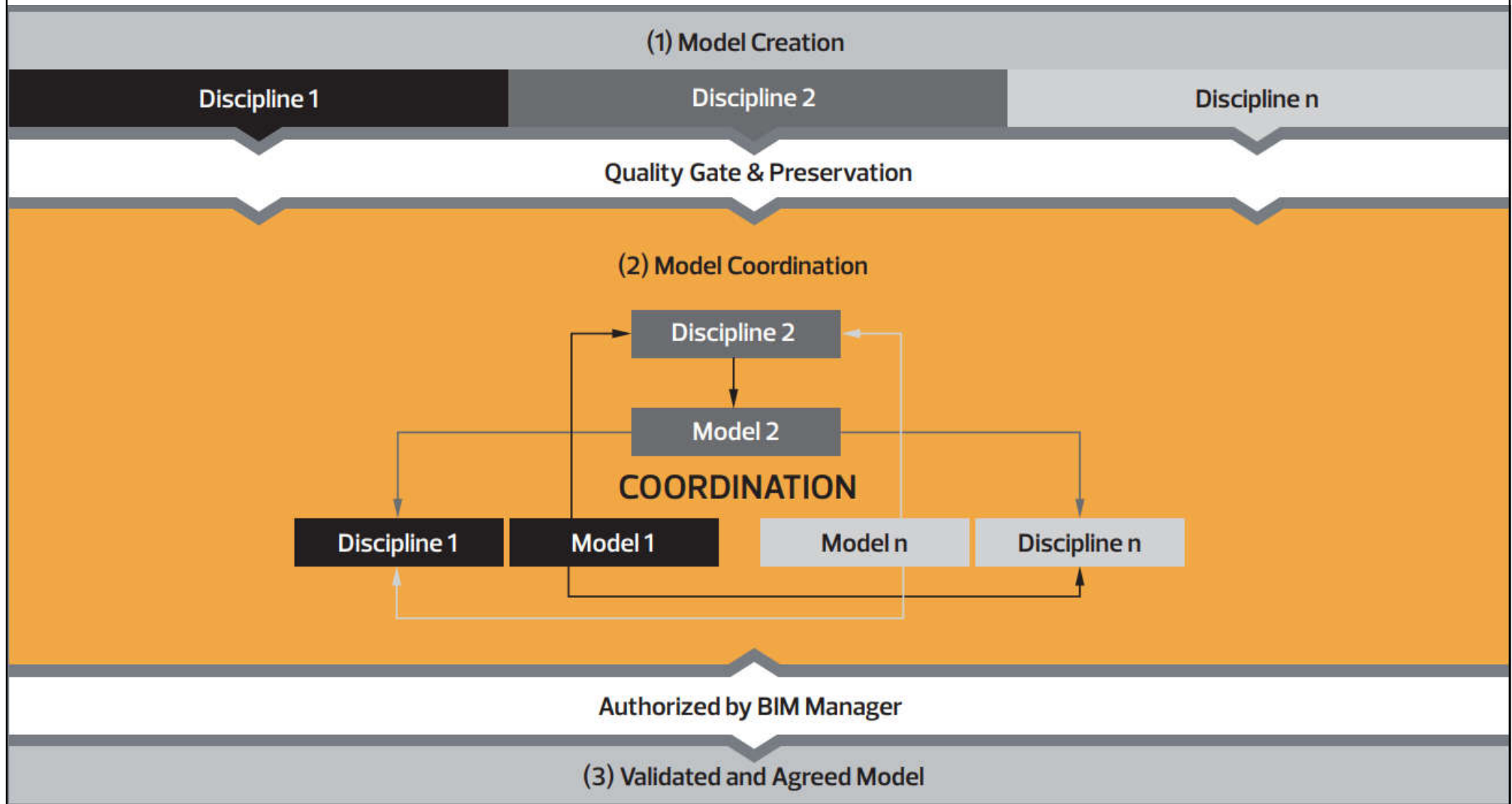

BIM-based coordination

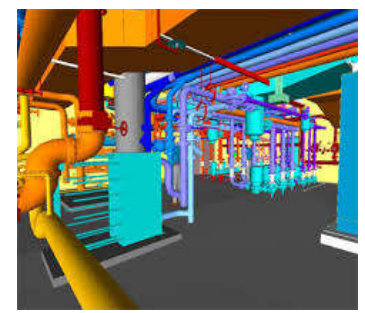

- Model-based collaboration
 - With digital, structured building models
 - Discipline-oriented or Federation model approach
 - Every author, in accordance with their discipline, is responsible for their own digital model and shall have access for this model content only
 - Discipline model, submodel or technical model
 - With clear allocation of authors to individual discipline models, the components and changes can be organized clearly

BIM-based coordination



- Model-based collaboration (cont'd)
 - To safeguard the integrity and consistency of the entire model, the technical models must be checked at regular intervals by the BIM manager in a coordination environment
 - The organization and management of digital information and associated processes is the principle task during the entire BIM-based construction project, under a Common Data Environment (CDE)

Design coordination in BIM

Design Coordination Guide

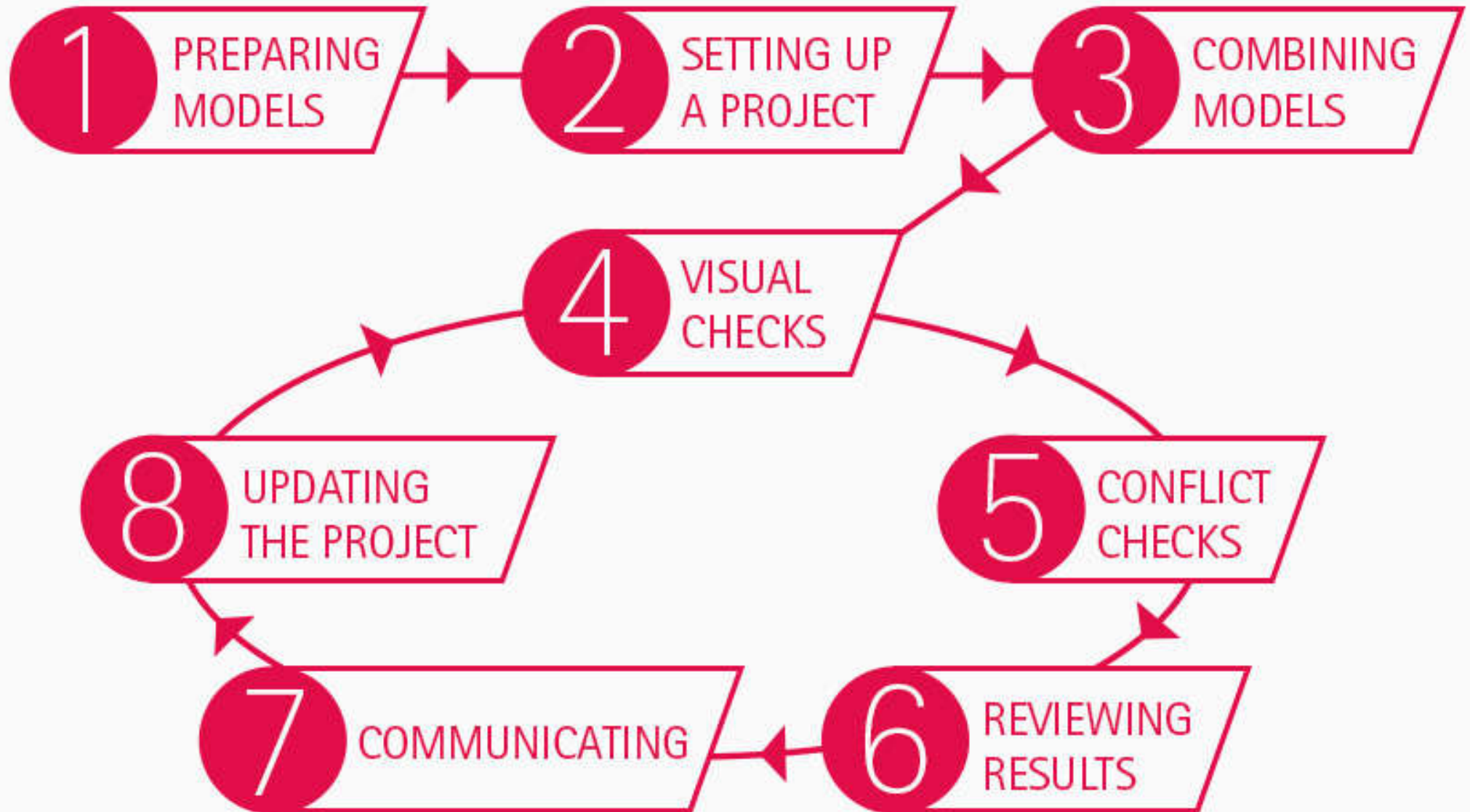

Example of Common Data Environment (CDE)

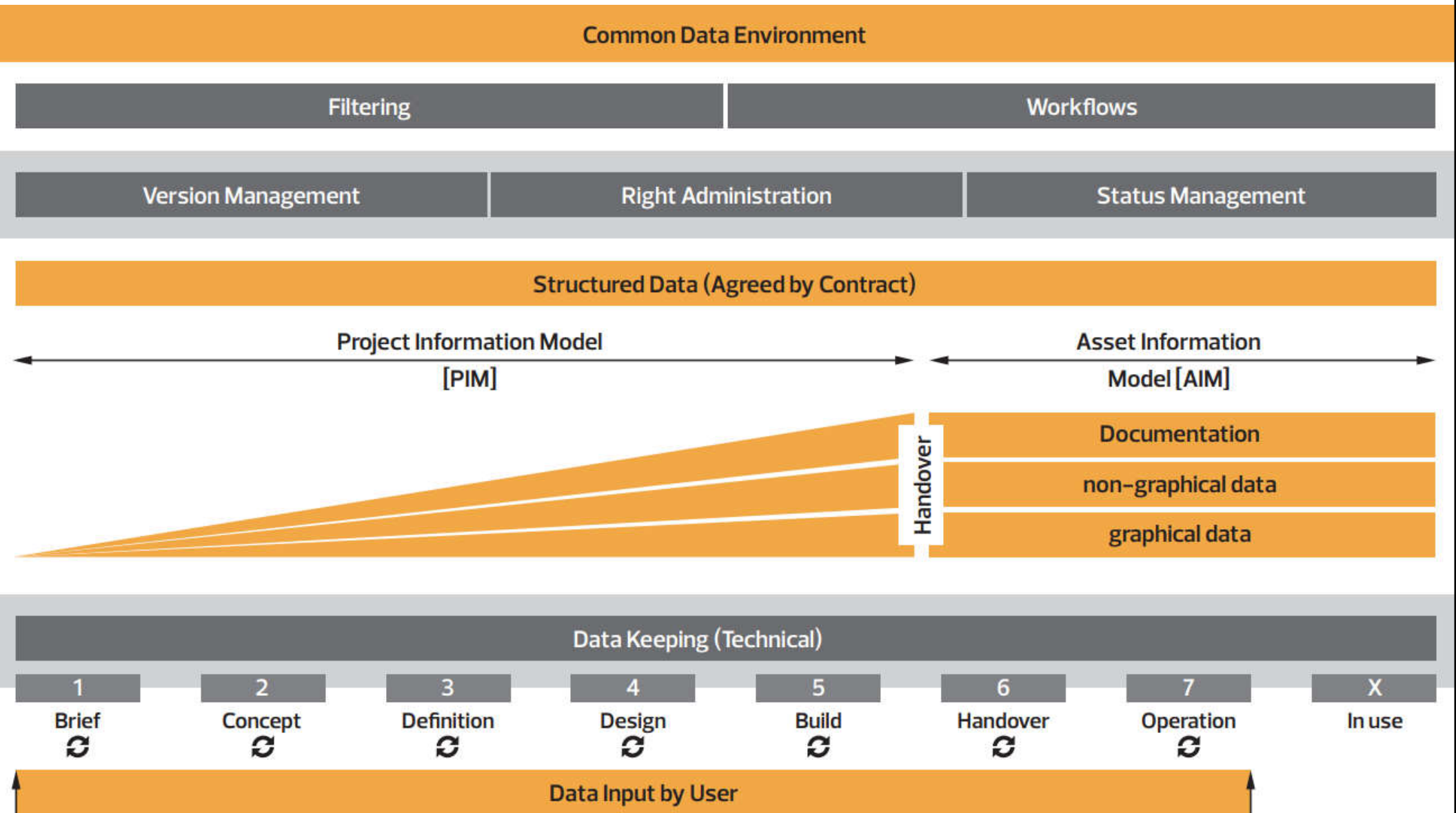

BIM-based coordination

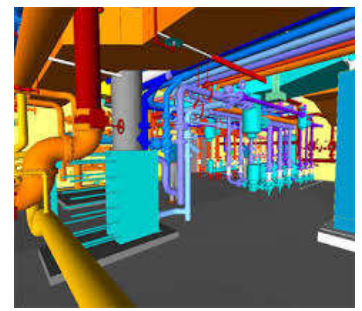

- Common Data Environment (CDE)
 - An information management strategy generally using a piece of software or a paper process
 - Create a single source of truth (SSOT) for any given project (or asset)
 - To collect manage and disseminate all relevant approved project documents for multi-disciplinary design teams members (architects, engineers, MEP) in a managed process

BIM-based coordination

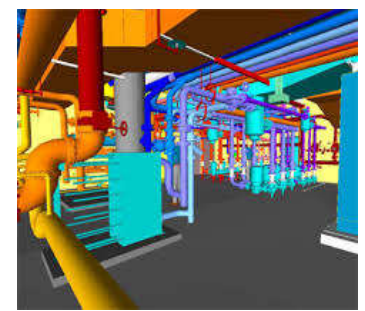

- Common Data Environment (CDE) (cont'd)

- The centralization of the stored data within the CDE reduces the risk of redundancies and simultaneously ensure that all data is up-to-date
- The CDE results in a higher reuse rate, simplifies the aggregation of model information and at the same time serves as the central platform for archiving and documentation

(See also: Common data environment CDE https://www.designingbuildings.co.uk/wiki/Common_data_environment_CDE)

(Source: https://info.allplan.com/hubfs/07_Guides/Whitepaper_BIM_Integration_Framework_EN.pdf)

BIM-based coordination



- BIM Integration Framework (BIF)
 - It represents a software concept which can establish the link from any BIM tool to a CDE
 - Provide seamless integration of access
 - BIF assembles all functions of the interface
 - Functions are simultaneously standardized regardless of the BIM tool used, in order to enable smooth collaboration (e.g. information exchange, process management or communication)

Collaboration processes based on the BIM Integration Framework

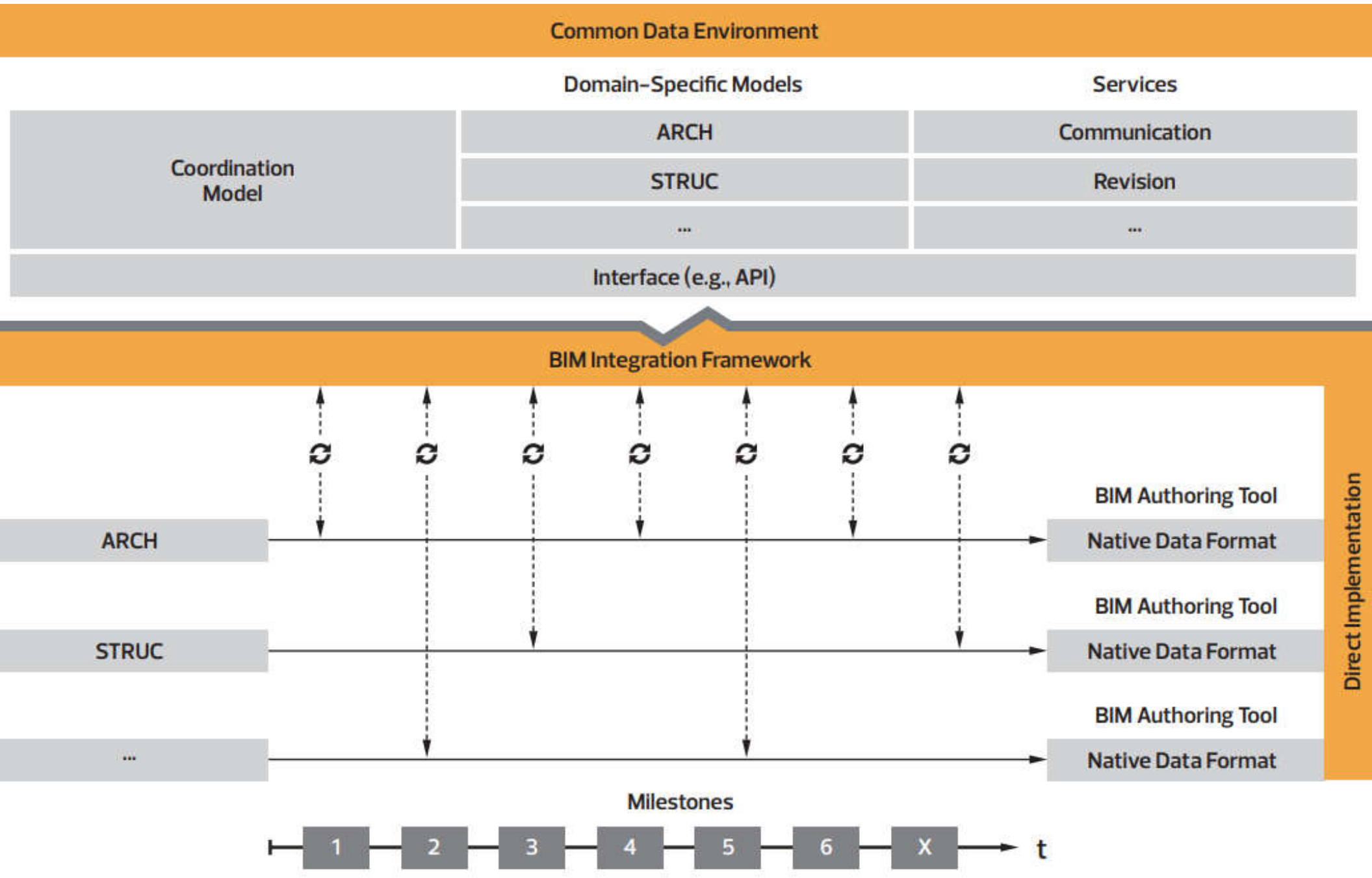

(Source: [https://info.allplan.com/hubfs/07_Guides/Whitepaper BIM Integration Framework EN.pdf](https://info.allplan.com/hubfs/07_Guides/Whitepaper_BIM_Integration_Framework_EN.pdf))

Examples of BIM use in building, construction and infrastructure

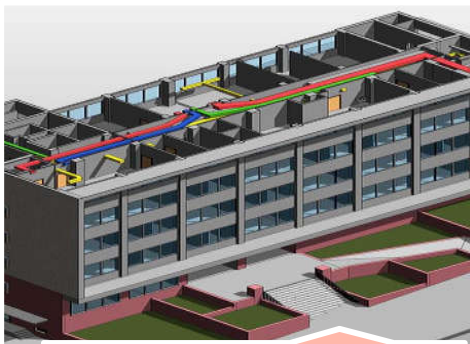

Architectural

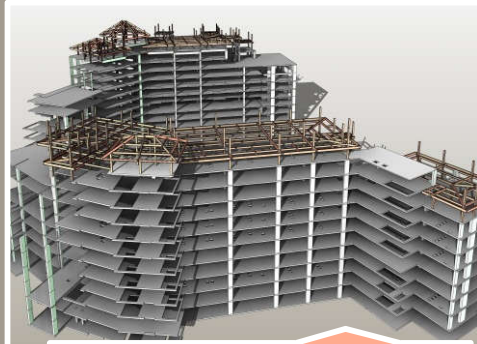

Structural



MEP



Co-ordination

Wall Schedule					
Wall Us	Function	Acoustic Rating	Fire Rating	Compartmentation	Area
aring	Exterior			<input checked="" type="checkbox"/>	16346
aring	Exterior			<input checked="" type="checkbox"/>	128854
aring	Exterior	40	E160	<input checked="" type="checkbox"/>	11044
aring	Interior	40	E160	<input checked="" type="checkbox"/>	20879
aring	Interior	40	E160	<input checked="" type="checkbox"/>	106001
aring	Interior	40	E160	<input checked="" type="checkbox"/>	21729
aring	Interior	40		<input checked="" type="checkbox"/>	8631
aring	Exterior			<input checked="" type="checkbox"/>	841
aring	Interior			<input checked="" type="checkbox"/>	17520
aring	Interior	40	E160	<input checked="" type="checkbox"/>	33148
aring	Interior	40	E160	<input checked="" type="checkbox"/>	20674
					385871
aring	Exterior			<input checked="" type="checkbox"/>	15079
aring	Exterior			<input checked="" type="checkbox"/>	777

Scheduling



Clash Detection

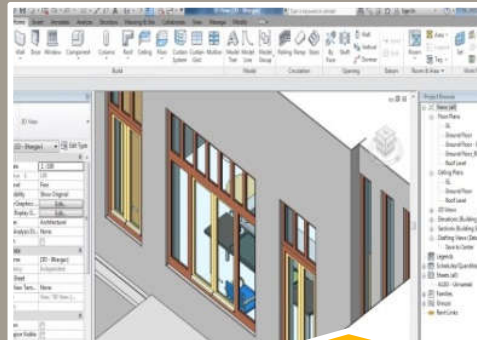

Family Creation

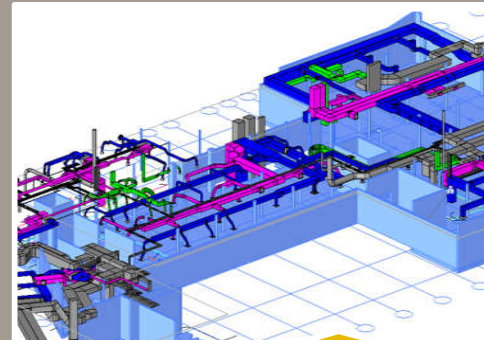

BIM Co-ordination Model

A sample model and linking structure for the Architectural discipline

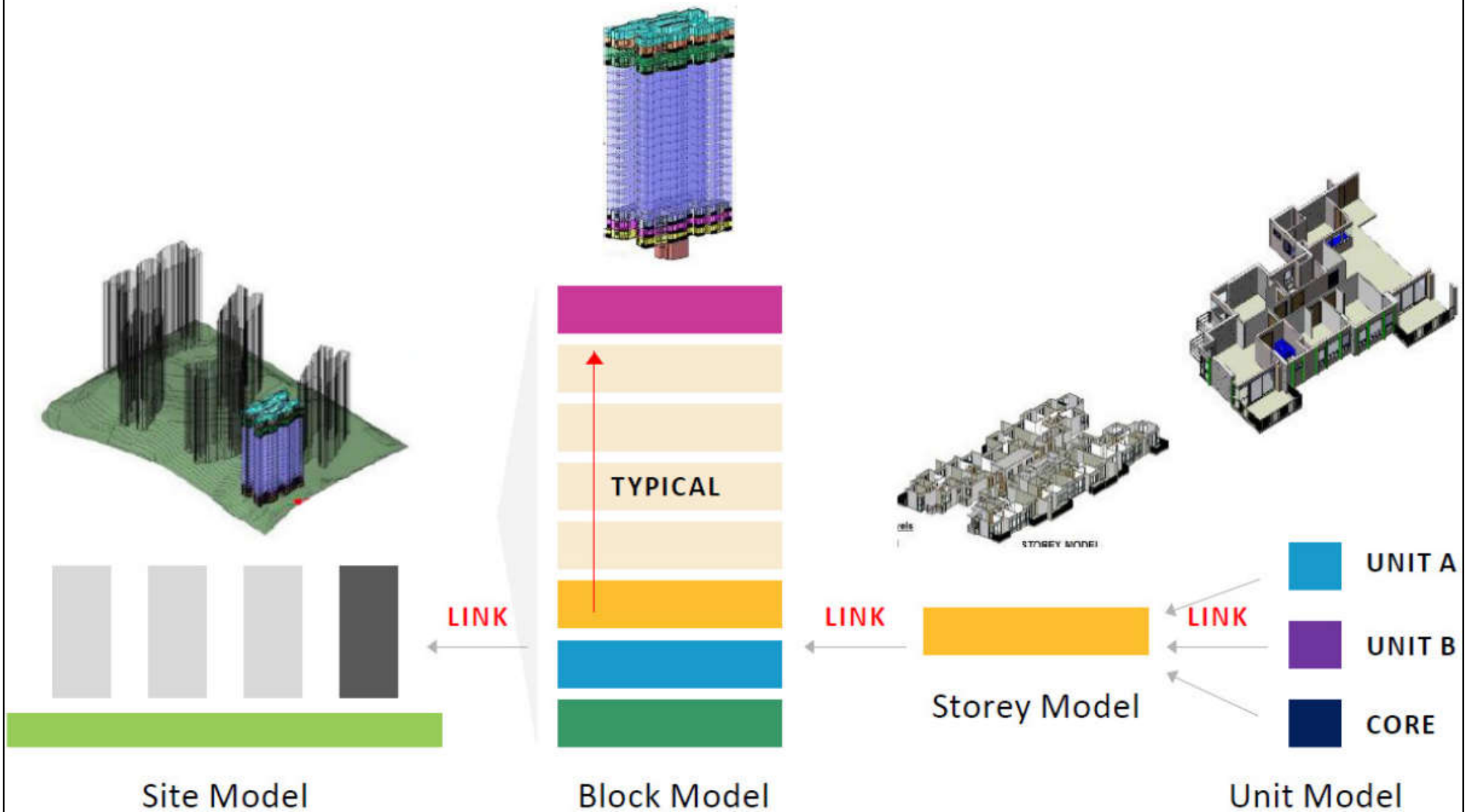

A sample model and linking structure for the Structural discipline

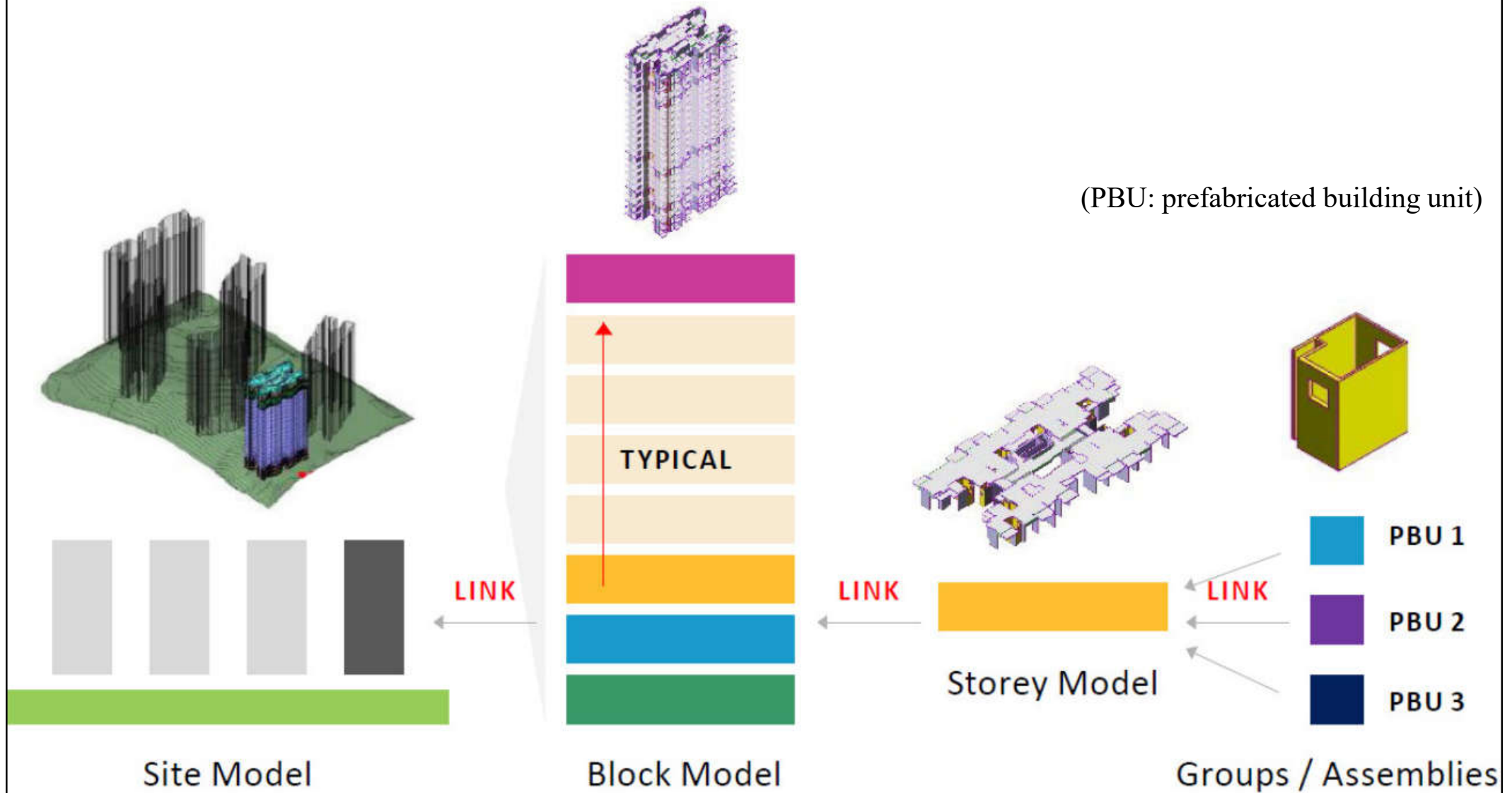

A sample model for the MEP (Building Services) discipline

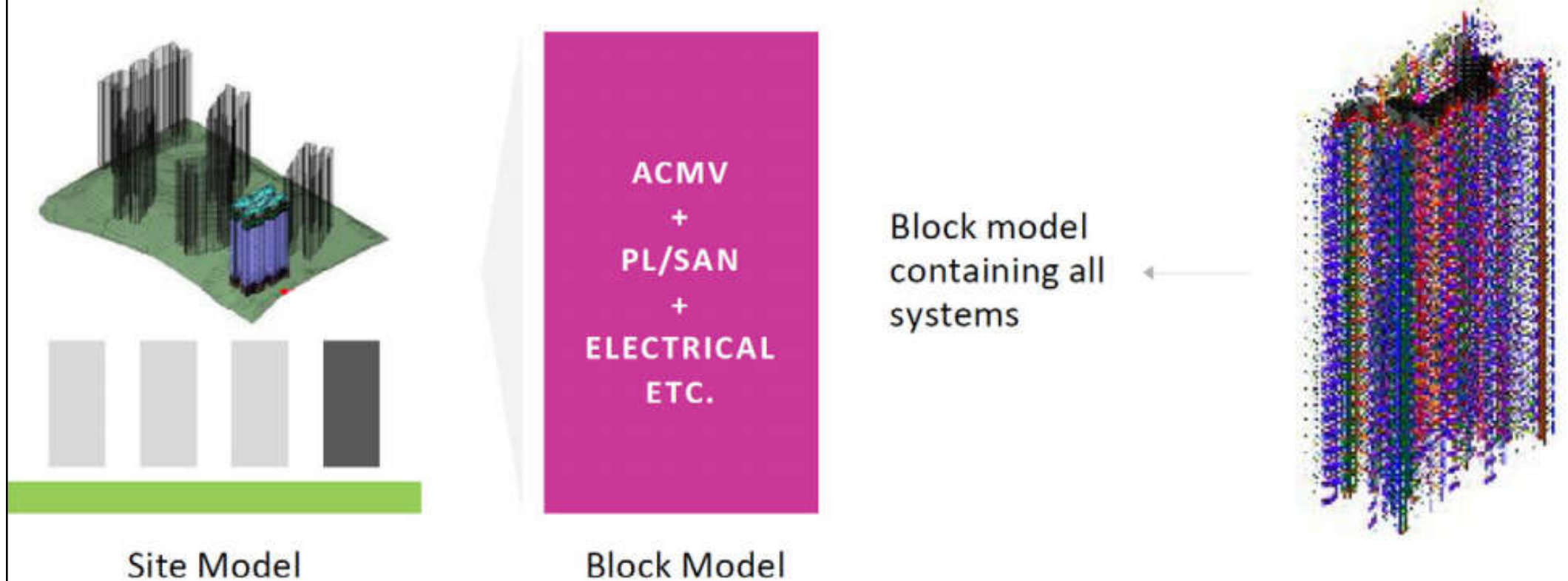

All systems within one zone/block as one file.
Depending on model size, one system of one zone/block in one file (This makes it easier to handover files to different MEP subcontractors for their further development and use), where each system may be further split up into floors if needed.

(ACMV: air-conditioning & mechanical ventilation; PL/SAN: plumbing/sanitation)

Typical coordination issues that are critical to construction

<p>Architectural – Structural Coordination</p> <ul style="list-style-type: none">• Column setting out and alignment between Architectural and Structural models• Ceiling to structural framing coordination• Staircase and ramp coordination	<p>Structural – MEP Coordination</p> <ul style="list-style-type: none">• Critical penetrations especially of large pipes and MEP services into structural framing• MEP openings into structural walls• Underground MEP services to structural foundation
<p>Architectural – MEP Coordination</p> <ul style="list-style-type: none">• Service shaft coordination• Ceiling to concealed MEP services coordination	<p>Arch-Structure-MEP</p> <ul style="list-style-type: none">• Toilet setting out, including coordination of tile layout, floor drains, and fixtures• Façade coordination

Main responsibilities of the **BIM co-ordinator**

- Developing and maintaining the project's BIM Protocol
- Following the mandated BIM collaboration format (BCF)
- Co-ordinating stakeholders in terms of their role within the BIM process
- Ensuring the accuracy of models and datasets by establishing quality control procedures
- Using clash detection software to identify clashes
- Where there are shared data and inter-model relationships, e.g. shared project coordinates, floor levels, etc., making sure these are recorded and monitored
- Co-ordinating data modelling and management
- Liaising with the design team and client

BIM coordination tasks:

- Clash detection & resolution
- Interactive walk-through & fly-by animations
- Virtual mock-up & review

Integration of BIM & production planning / scheduling: From master planning to weekly work planning

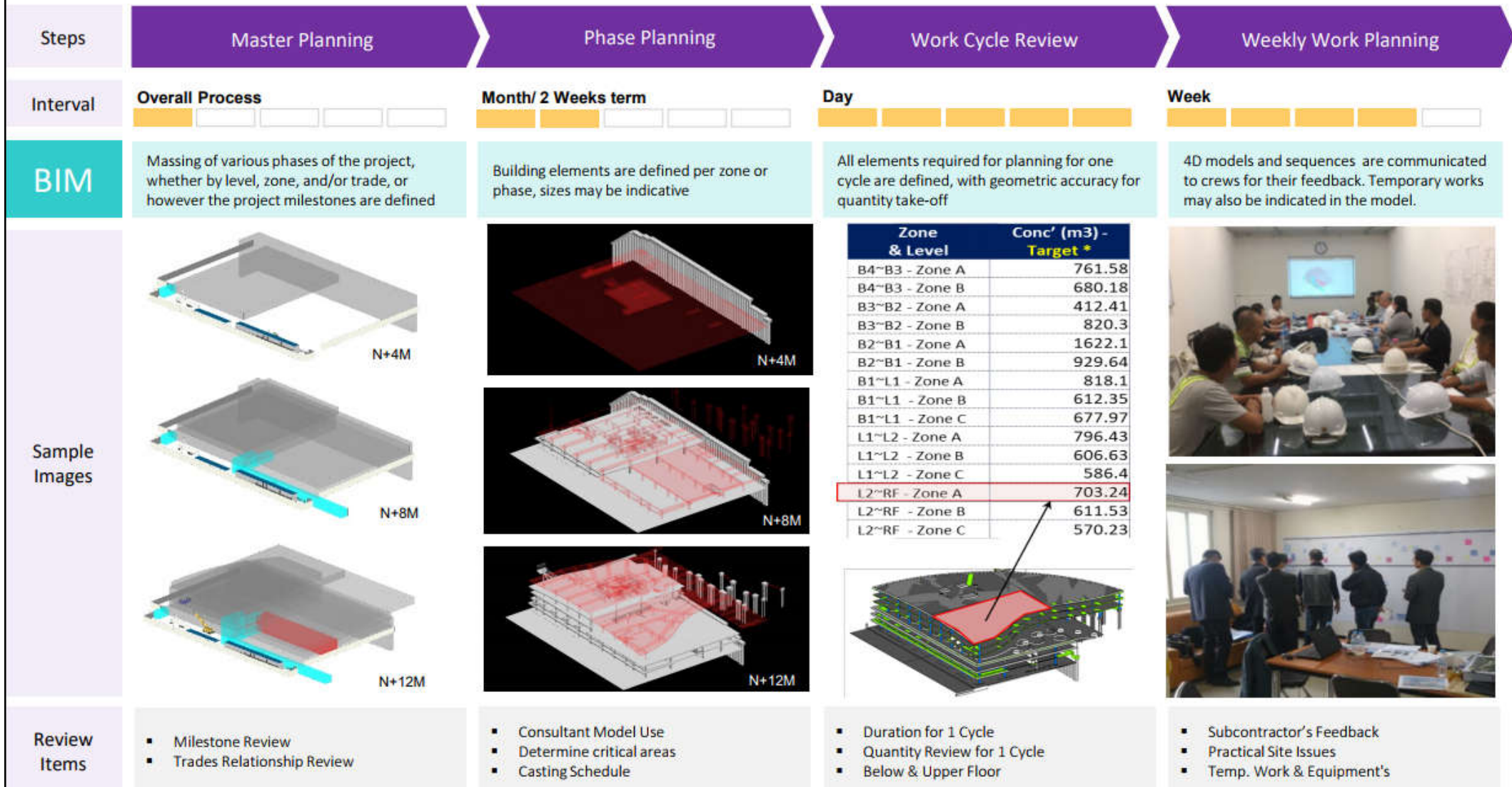

Integration of BIM & production planning / scheduling: Weekly and daily coordination, review and tracking

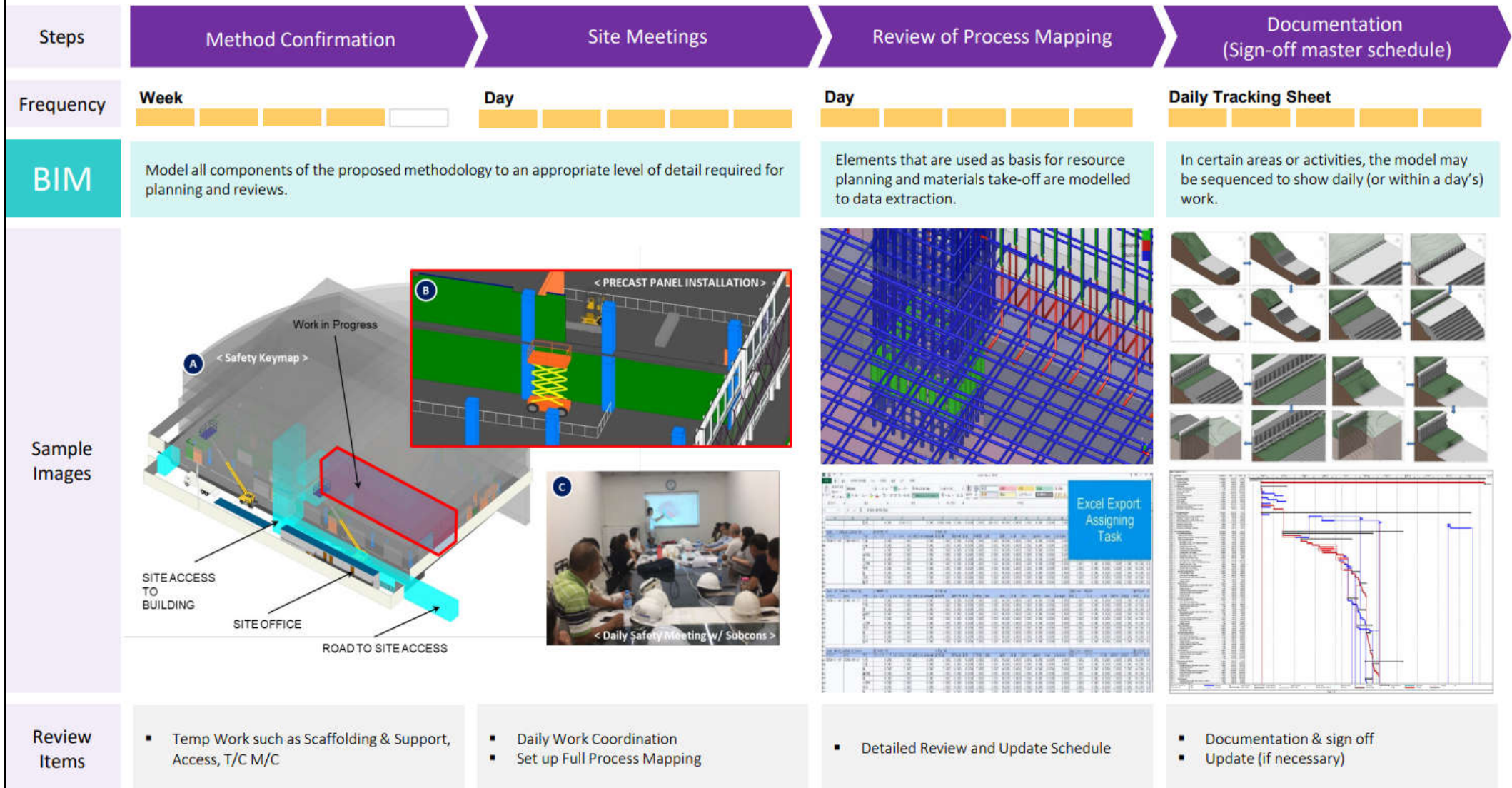

An example of coordination matrix

	ARCHITECTURAL					STRUCTURAL					MEP									
	Ceiling	Rated Walls	Floors	Casework	Furnishings	Structural Foundation	Structural Column	Structural Framing	Structural Wall	Slab	Steel & Pre-Cast	Mechanical Ductwork	Mechanical Piping	Mechanical Equipment	Mechanical Fixtures	Plumbing Piping	Electrical Equipment	Electrical Fixtures & Devices	All equipment with clearances	Specialty Equipment
Mechanical Ductwork	1	2					3	3	3	3	3									
Mechanical Piping	1	2					3	3	3	3	3									
Mechanical Equipment												13								
Mechanical Fixtures												13								
Plumbing Piping																				
Electrical Equipment											10	11	11	6	6	12				
Electrical Fixtures & Devices				7	8						10	11	11	6	6	12				
All equipment with clearances		4					5	5	5		5									
Specialty Equipment											9									

Sample virtual review coordination

Sample Virtual Review Coordination Issues

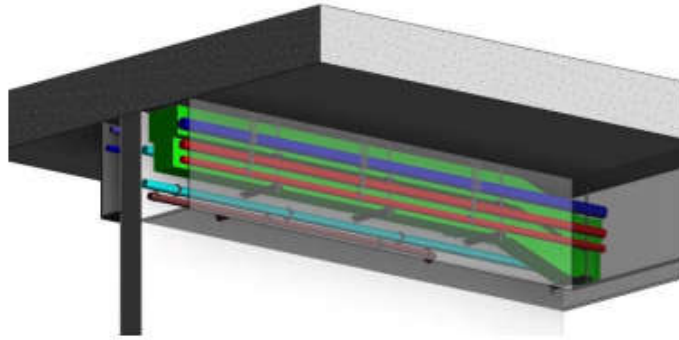

Coordination of MEP services inside of residential unit ceiling bulkhead

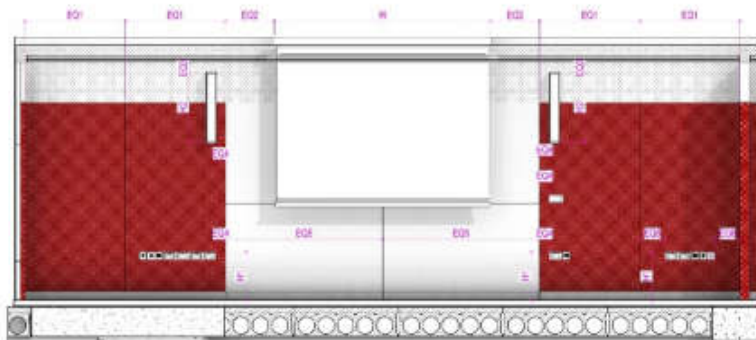

Coordination of M&E outlets, projects, whiteboard, and speakers with wall paneling alignment



-On 21 Nov 2016, PTA requested to switch for bath 1 to shift together with switch for master bedroom. CCDC to check.

-On 28 Nov 2016, CCDC informed that switch can be shifted, but the change will have abortive work, need to chase groove on PBU wall to the new locatopn. PTA will check and revert back.



- On 14 Nov 2016, PTA commented, Ceiling at master bedroom as per HPK-Archi-RFI-151, to be added.



- On 14 Nov 2016, PTA commented, power socket at balcony to be adjusted to 450mm height



- On 14 Nov 2016, Developer & PTA commented, the termination between laminate floor & kitchen floor tile at bedroom 4 should use laminated end cap.
-On 21 Nov 2016, PTA commented, tiling shirling to be extended to wrap wardrobe dry wall to make.
-On 28 Nov 2016, PTA commented whether can use smaller end cap. And CCDC confirmed in the meeting that 20mm is smallest size after clarification with Weavepact



Sample virtual sequencing for residential unit mock-up

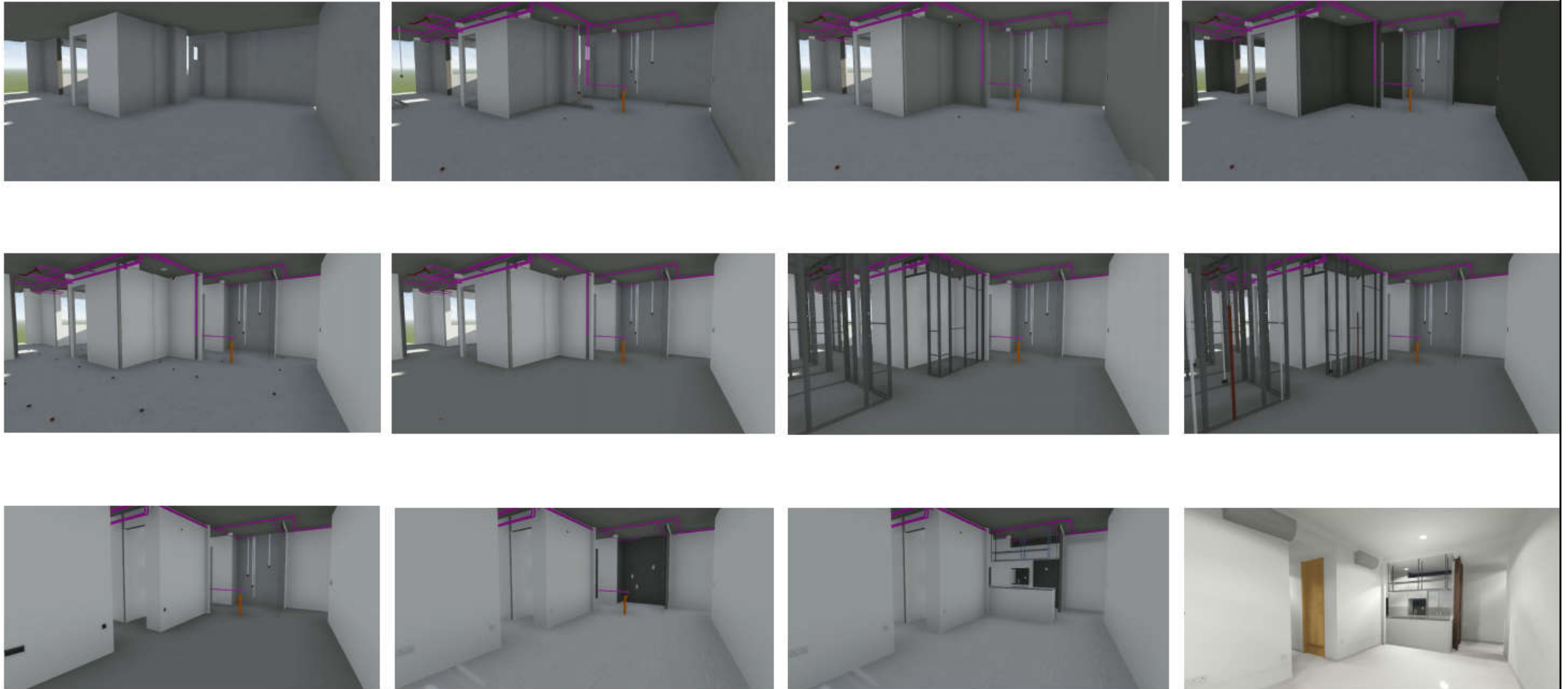

Crane capacity planning

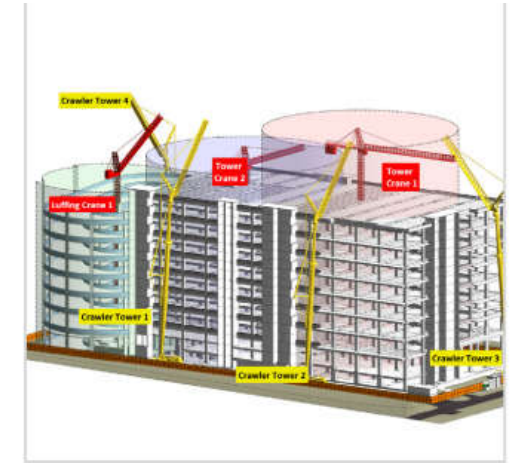
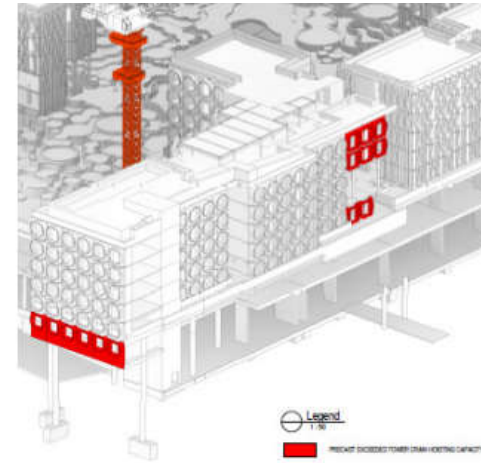
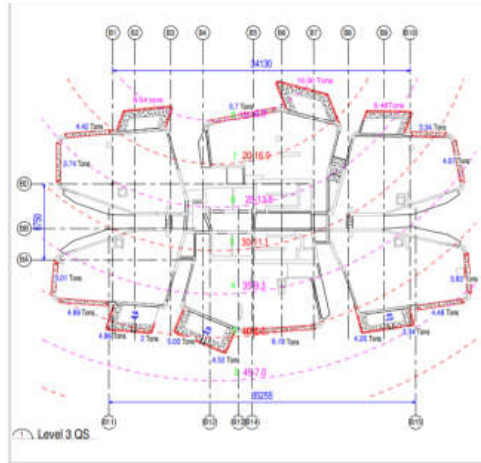
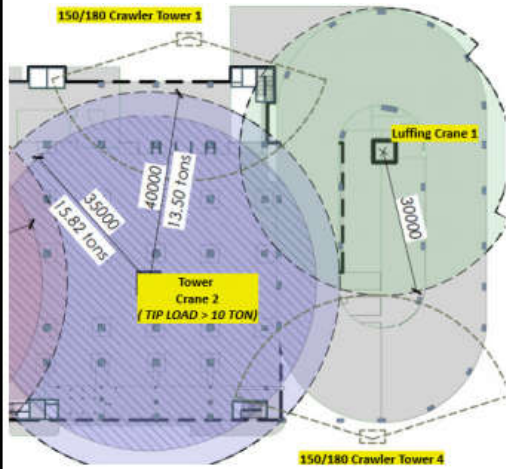

STEP 1

Model in Tower Cranes / crane to exact planned location

- Build in reach radii into object

STEP 2

Identify and prep all items to be hoisted in the model

- Modelled to exact location
- Modelled to exact overall size, dimensions, details as per fabrication
- Apply formula or scripting to calculate weight from each object OR manually key in

STEP 3

MANUAL METHOD:

- Tag weight for each items so that this annotation shows up in the model
- Visually check if every component weight is within load capacity for that reach radius

AUTOMATIC METHOD:

- Apply scripting to auto-detect and highlight items that are over weight

STEP 4

Adjust tower crane plan (add in more tower cranes) until all items (esp. heaviest or critical items) are within hoisting weight and reach



Further reading

- Video: Amazingly detailed 4D Animation with Fuzor VDC! (4:44) <https://youtu.be/sZ1XxGXFZrk>
- Common data environment CDE
 - https://www.designingbuildings.co.uk/wiki/Common_data_environment_CDE
- BIM co-ordinator
 - https://www.designingbuildings.co.uk/wiki/BIM_co-ordinator
- CS122402: BIM Implementation in the Construction of a Complex Intersection of Utility Tunnels (Duration 43:52) (a real-life project in Shanghai)
 - <http://au.autodesk.com/au-online/classes-on-demand/class-catalog/classes/year-2017/bim-360-glue/cs122402>