

Introduction to HVAC&R systems



Ir. Dr. Sam C. M. Hui

Faculty of Science and Technology

E-mail: cmhui@vtc.edu.hk

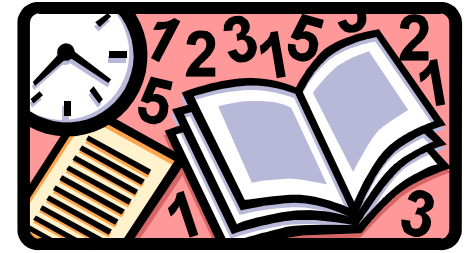

Background

- Required basic knowledge:
 - Fluid Mechanics, Thermodynamics
- Related courses:
 - SPD5132 Indoor Environmental and HVAC Systems
 - SPD5141 Building Services System Design
- This course may be useful to SPD5152 Industry-Based Student Project (individual project)

Background

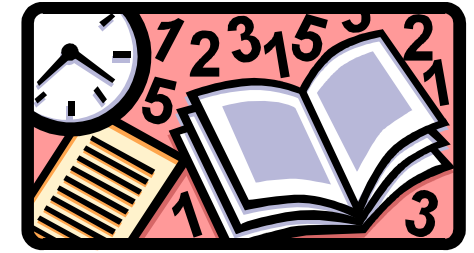

- Learning Outcomes:

- 1. apply the thermal comfort, heat balance and transfer concepts in loading estimation;
- 2. analyse the basic air conditioning processes and cycles and their application in simple air conditioning systems using the basic concepts of thermodynamics;
- 3. select the appropriate air conditioning and refrigeration system components in practical applications with consideration of various aspects such as health, energy and environment; and
- 4. apply the basic principles of sound in carrying out ventilation noise analysis and prediction



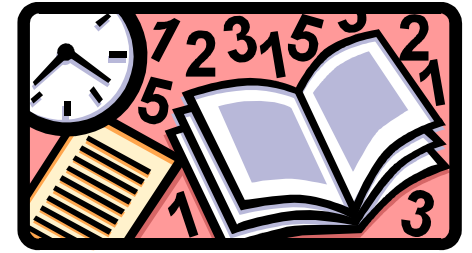

Background

- Lecturers:
 - Dr. Sam C. M. Hui (cmhui@vtc.edu.hk)
 - Dr. Yimo Luo (yimo.luo@vtc.edu.hk)
- Assessment Methods:
 - Test (20%) (mid-term)
 - Assignment (10%)
 - Practical exercise (10%) (lab experiment)
 - Examination (60%) (2 hours)
- Course Website: (with links and resources)
 - <http://ibse.hk/SPD4121/>

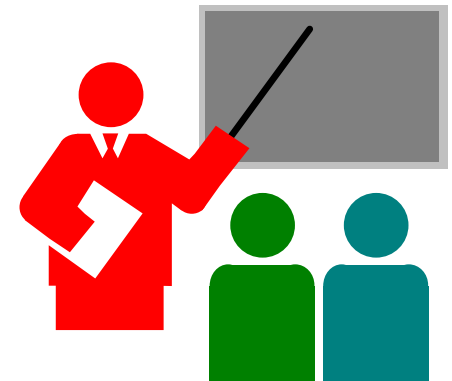

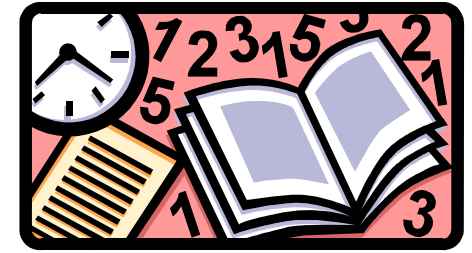

Background

- ***Ir. Dr. Sam C. M. Hui*** (*Building Services Engineer*)



- PhD, BEng(Hons), CEng, CEM, BEAP, BEMP, HBDP, MASHRAE, MCIBSE, MHKIE, MIESNA, LifeMAEE, AssocAIA
 - CEng = Chartered Engineer
 - CEM = Certified Energy Manager
 - BEAP = Building Energy Assessment Professional
 - BEMP = Building Energy Modeling Professional
 - HBDP = High-performance Building Design Professional
 - LifeMAEE = Life Member, Association of Energy Engineers
- ASHRAE Distinguished Lecturer (2009-2011)
- Research interests: energy efficiency in buildings and sustainable building technologies

Background

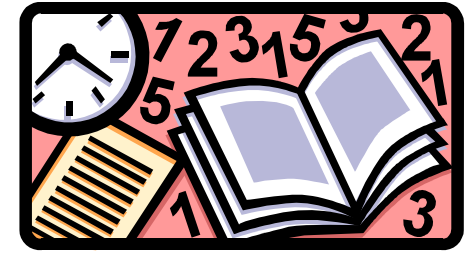

- Study topics:

- Introduction to HVAC&R systems
- Thermal comfort
- Psychrometry
- Air conditioning processes and cycles
- Load estimation
- Energy calculations
- HVAC air-side systems
- Air duct design
- Space air diffusion
- Mechanical and natural ventilation
- Refrigeration systems and cycles
- Sound and ventilation noise

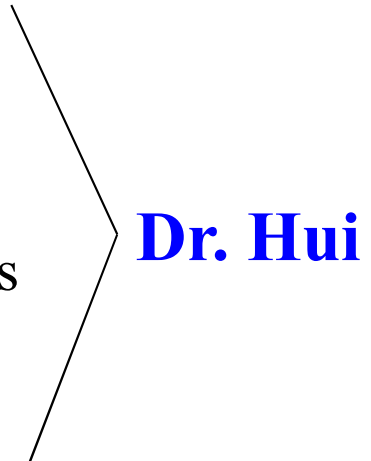

Dr. Hui

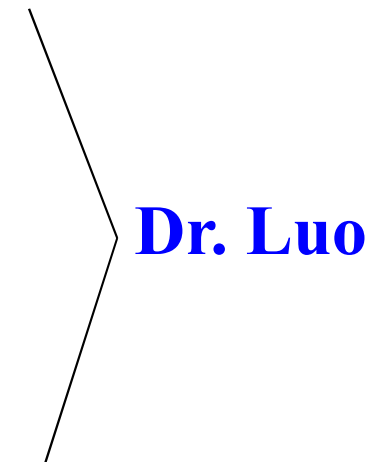
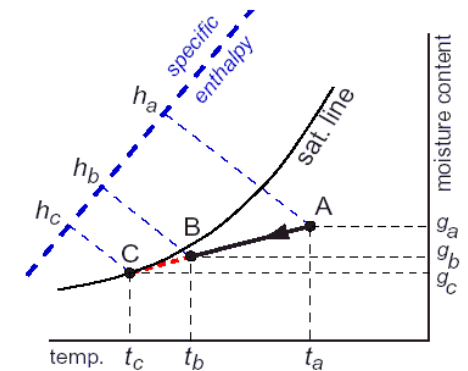

Dr. Luo



What is HVAC&R?



HVAC&R

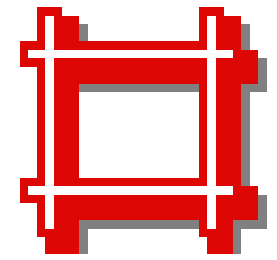

- What is HVAC&R?
 - HVACR is an acronym or abbreviation for the products and services related to the functions of:
 - **H**eating 採暖
 - **V**entilation 通風
 - **Air-C**onditioning 空調
 - **R**efrigeration 製冷



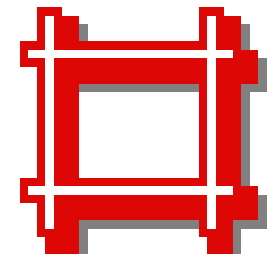

HVAC&R

- They are the engineering systems that help to control and maintain the conditions of indoor built environment
- Also known as:
 - Environmental control systems (ECS)
 - Heating, ventilating, air-conditioning and refrigerating (HVAC&R) systems
 - Heating, ventilating and air-conditioning (HVAC)
 - Mechanical ventilating and air-conditioning (MVAC)
 - Air conditioning and refrigeration (AC&R)

Example of a centralised HVAC system

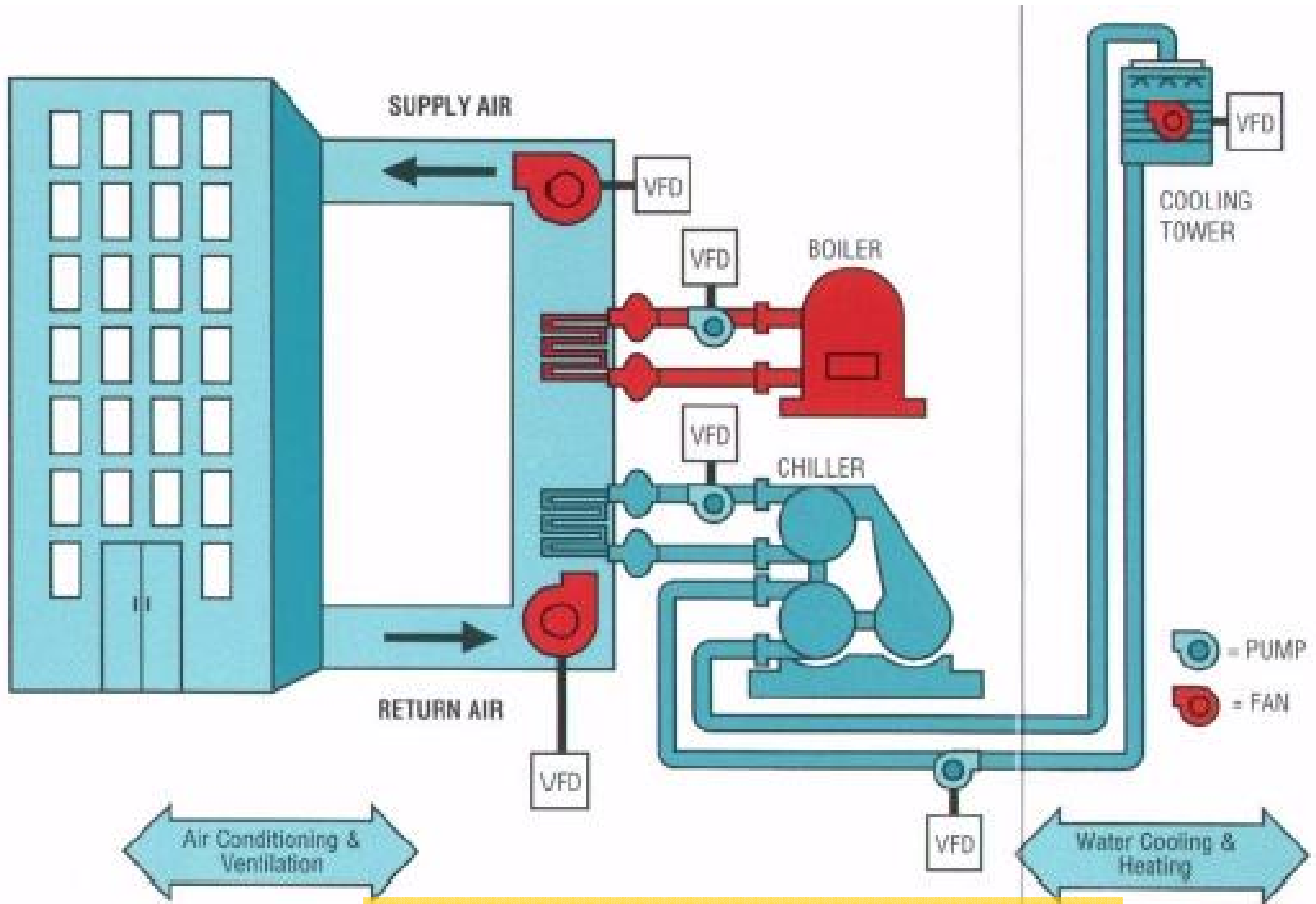

Do you know the HVAC components?

HVAC&R

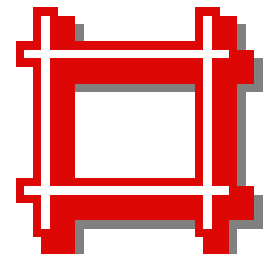

- Understand the purpose of HVAC design
 - To provide adequate indoor air quality by removing and/or diluting indoor pollutants
 - To provide adequate ventilation for processes
 - To remove heat & maintain thermal comfort
 - To control humidity & prevent condensation
- Understand the climate
 - Summer: cooling design & dehumidification
 - Winter: heating design

Simple ventilation design

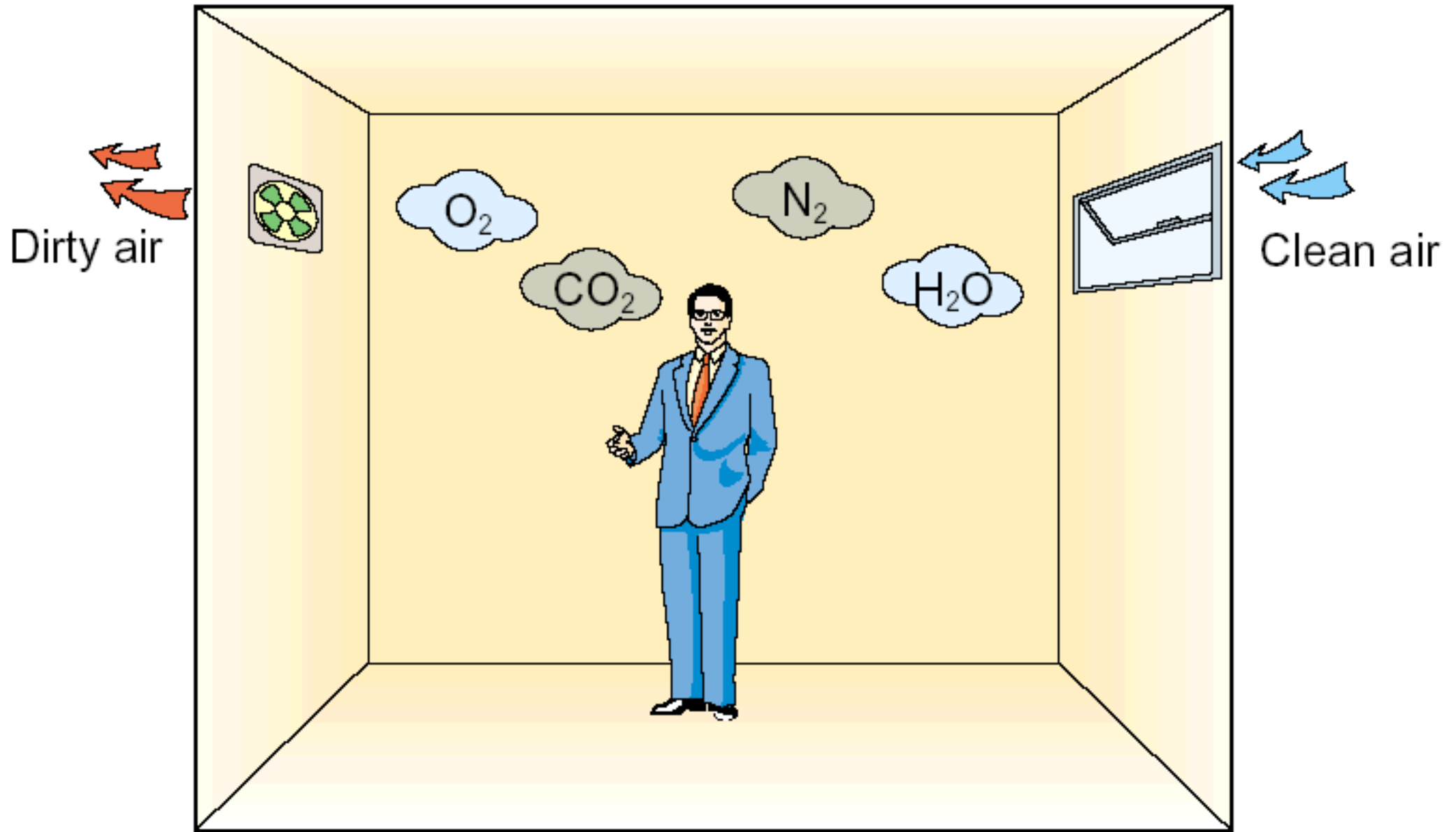

Cross ventilation

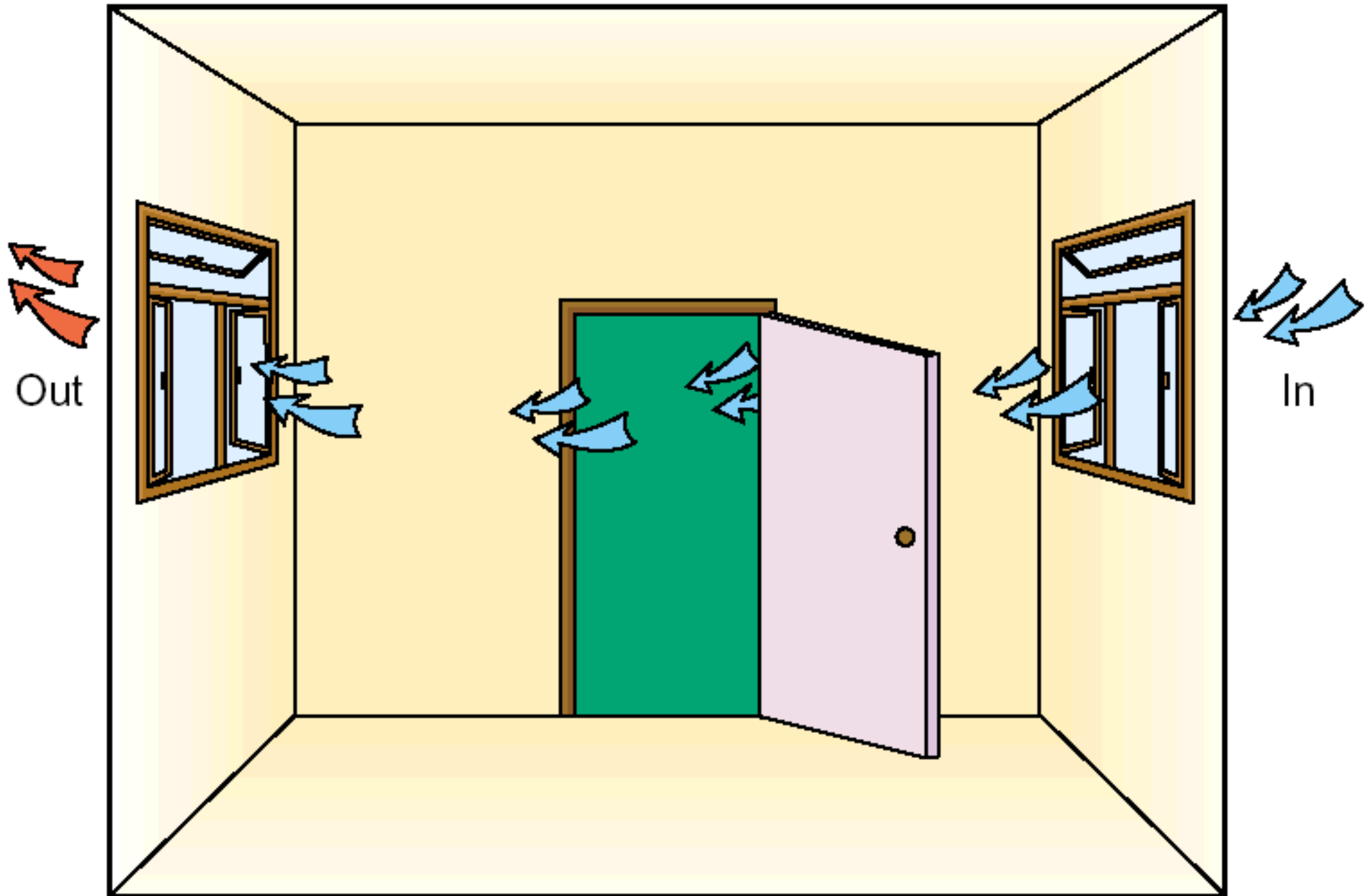

(Source: www.iaq.hk)

HVAC&R

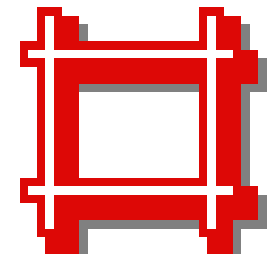

- Interactions affecting HVAC design

- Building fabric (architectural design)

- Site orientation & conditions
 - Built form, shading, window performance, thermal mass
 - Thermal insulation, reducing infiltration/air leakage

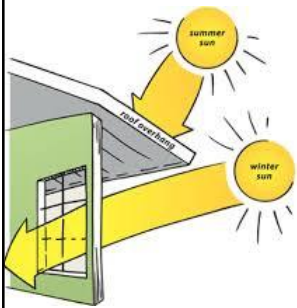

- Building services elements, e.g.

- Lighting system & daylighting
 - Small power or equipment loads



- Occupants' behaviour (human factors)

- How users behave and react

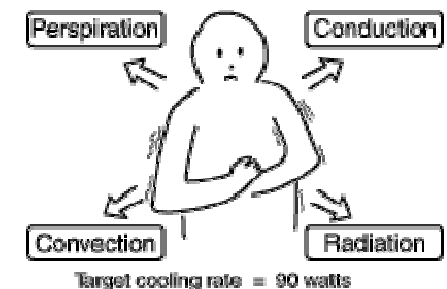

Can you identify all the heat gains?

Outdoor weather

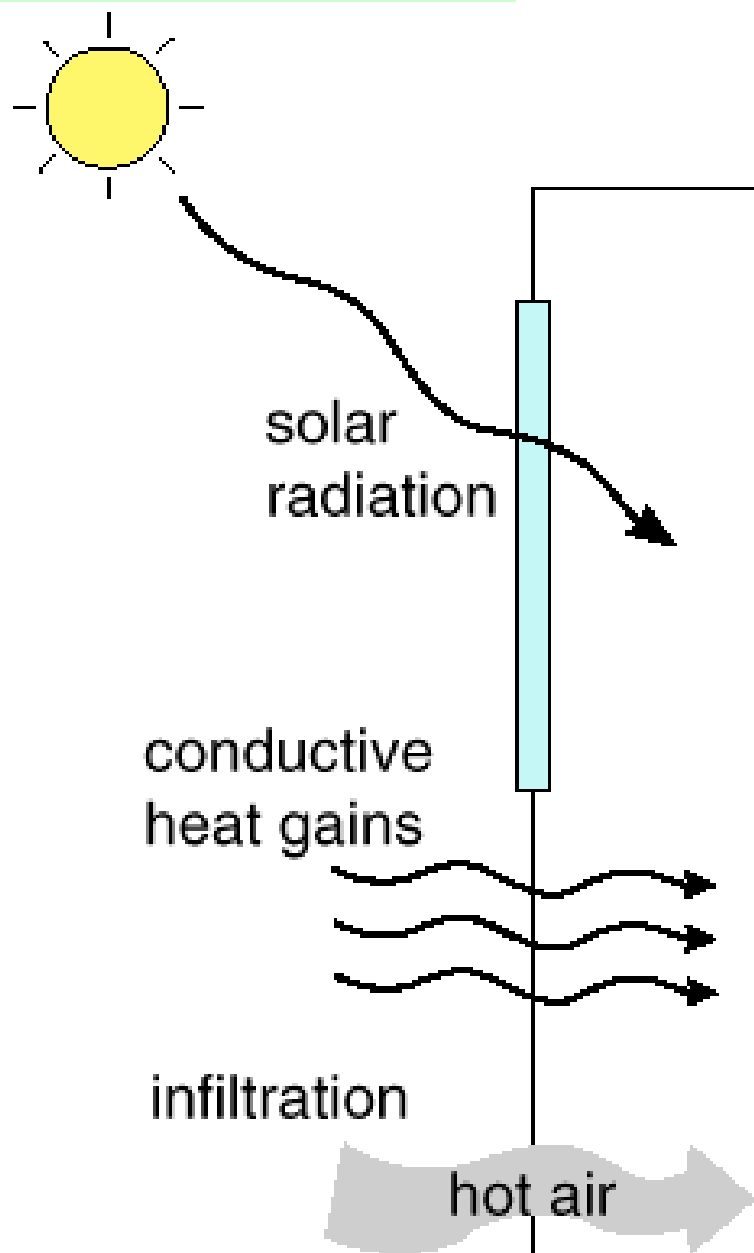

Sources of Cooling Load

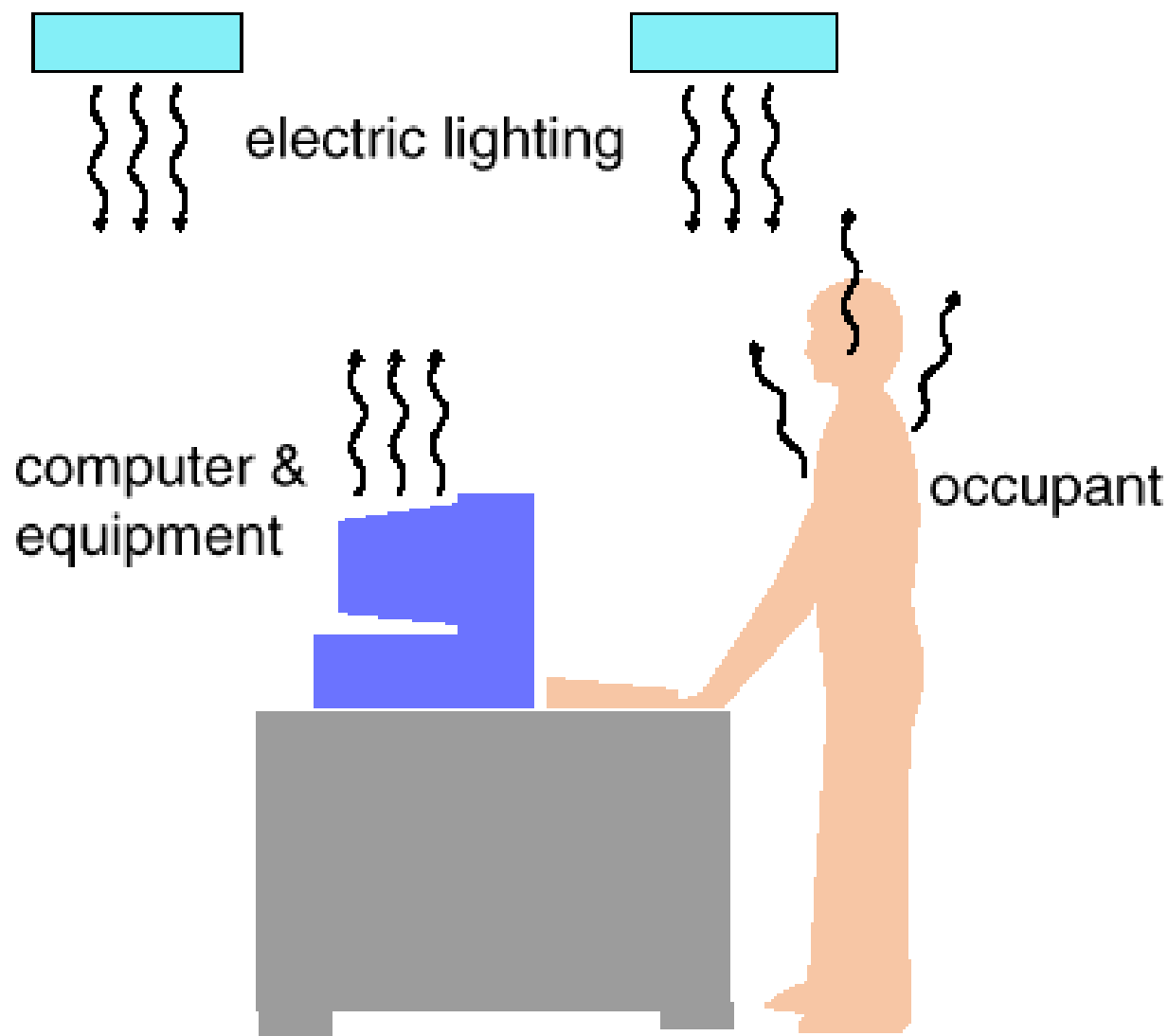

Indoor conditions and activities

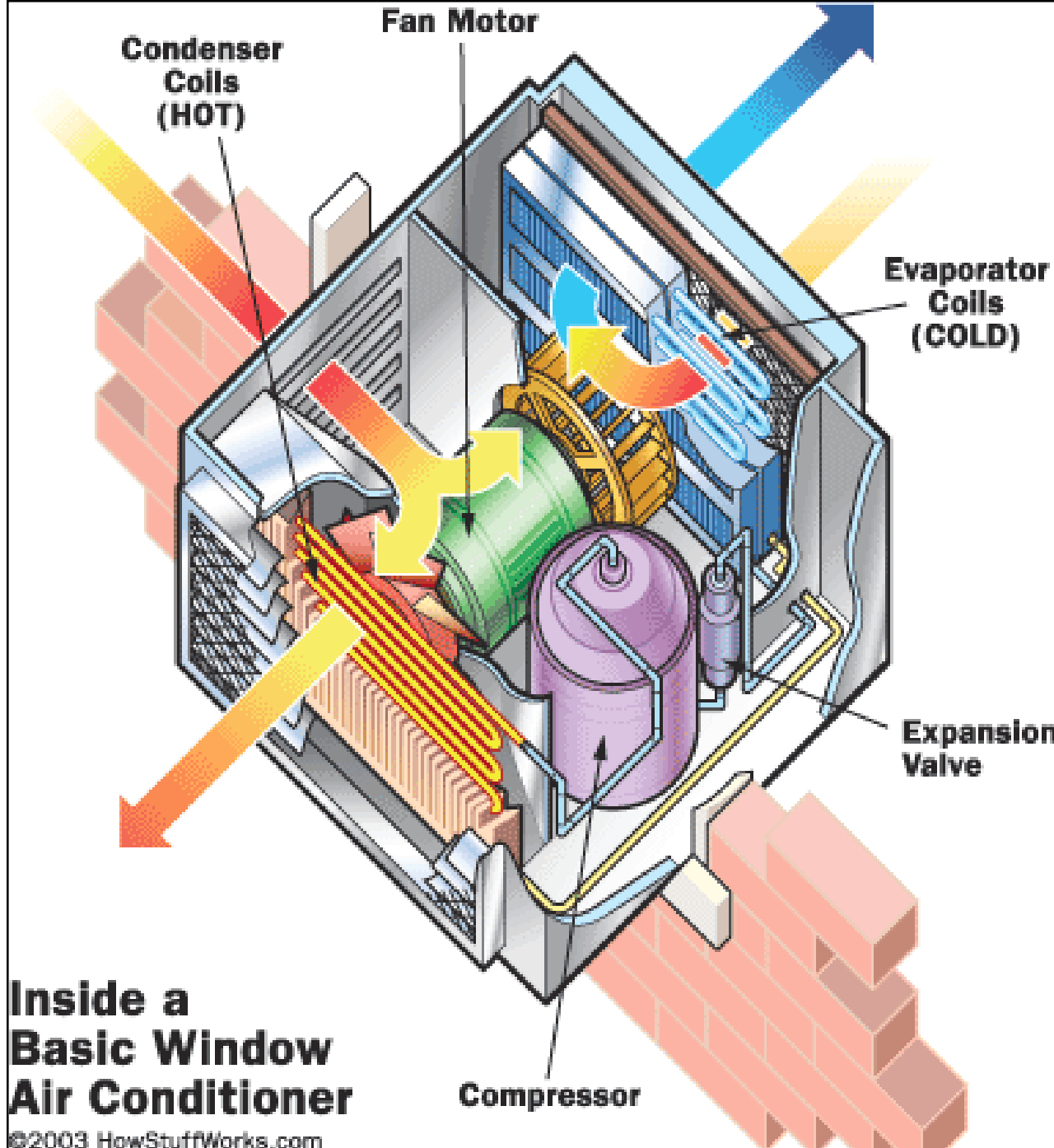

Inside a Basic Window Air Conditioner

©2003 HowStuffWorks.com

Window-type air conditioner

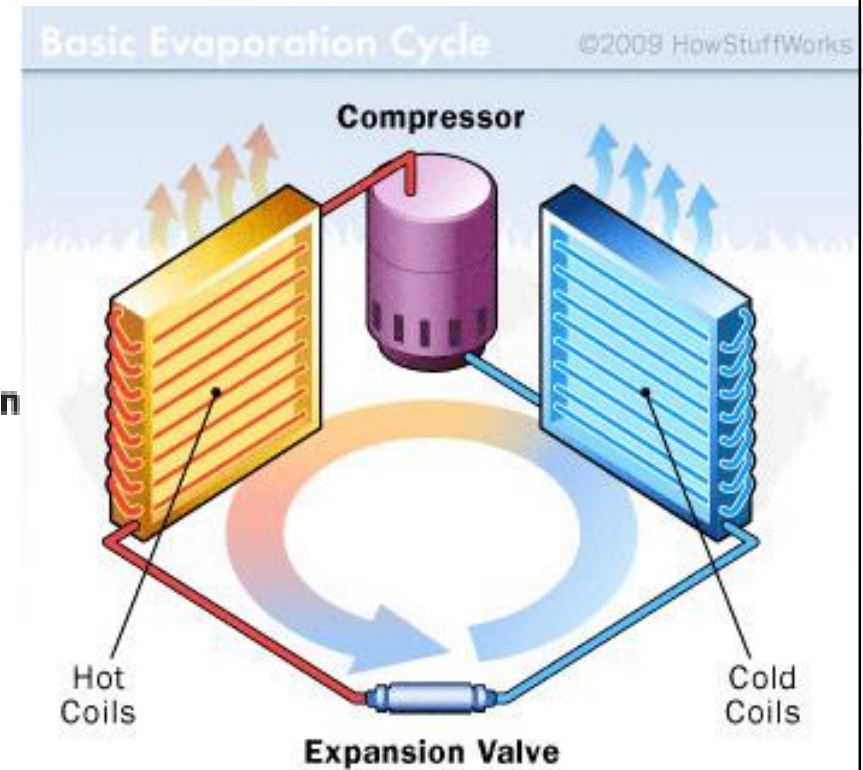

See also: “How Air Conditioners Work” (1:07)

<http://youtu.be/nKZ2DPvvua8>

(Source: www.howstuffworks.com/ac.htm)

Split-system Air Conditioning

©2009 HowStuffWorks

Split-type air conditioner

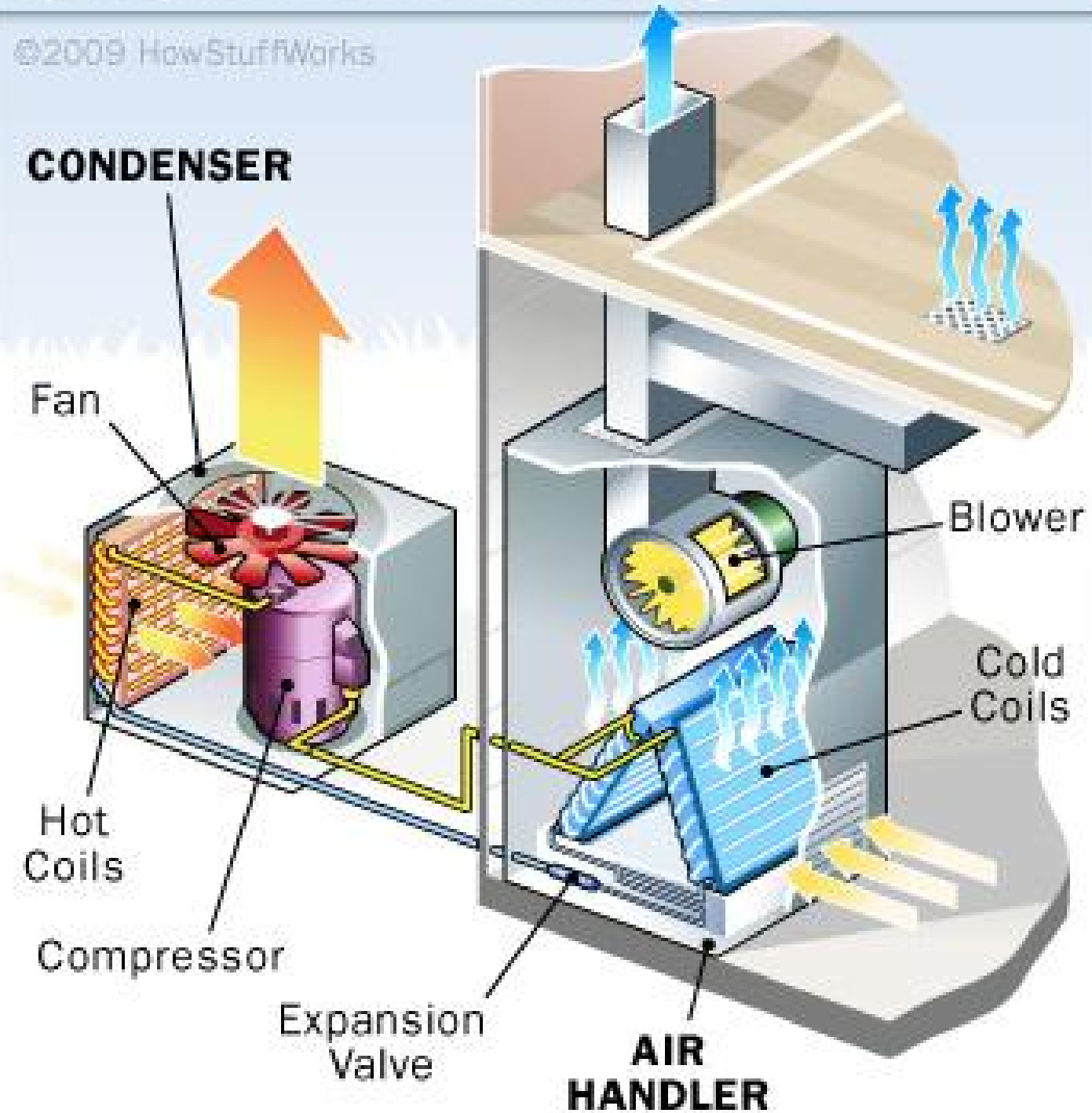

Refrigerant cycle

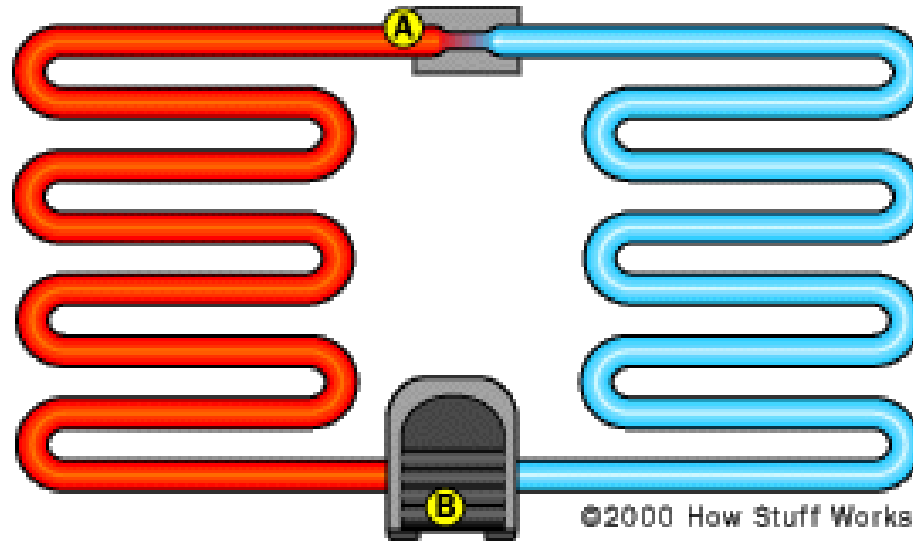

What are the major components?

A typical air conditioner

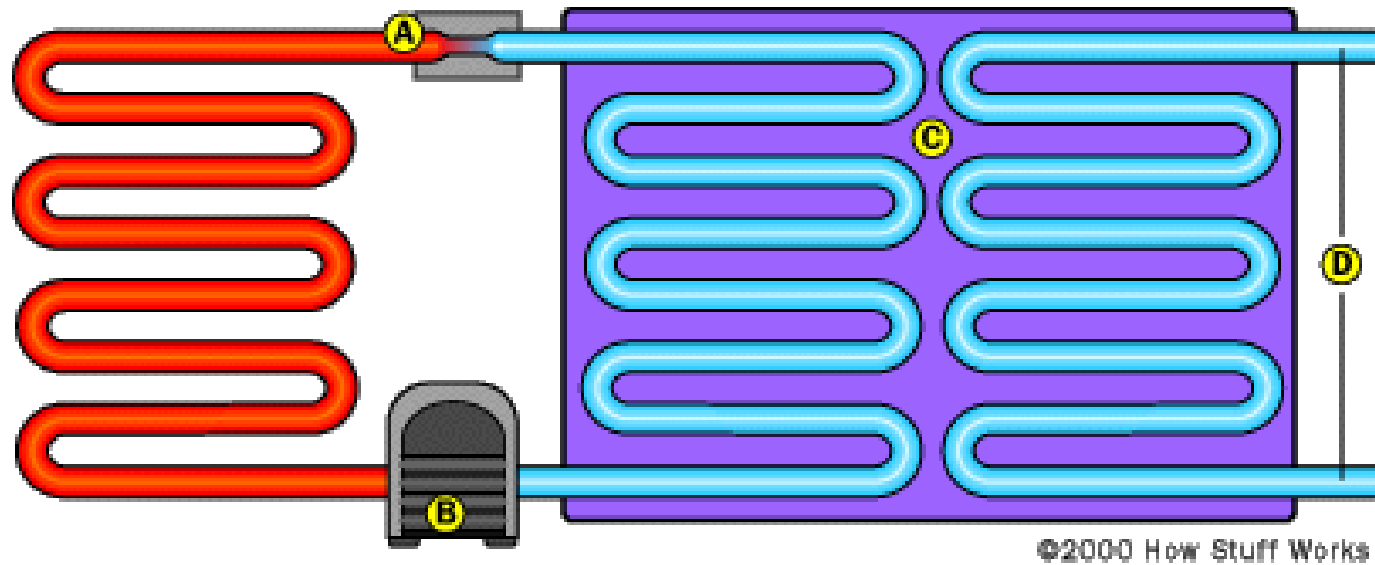

Chilled water system

Air conditioning with a chilled water system

Vapour compression refrigeration

Can you explain the principles?

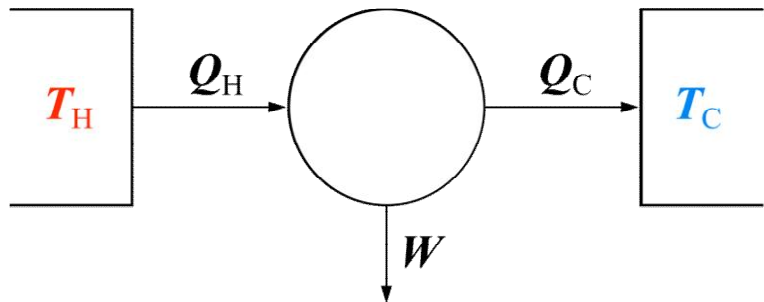
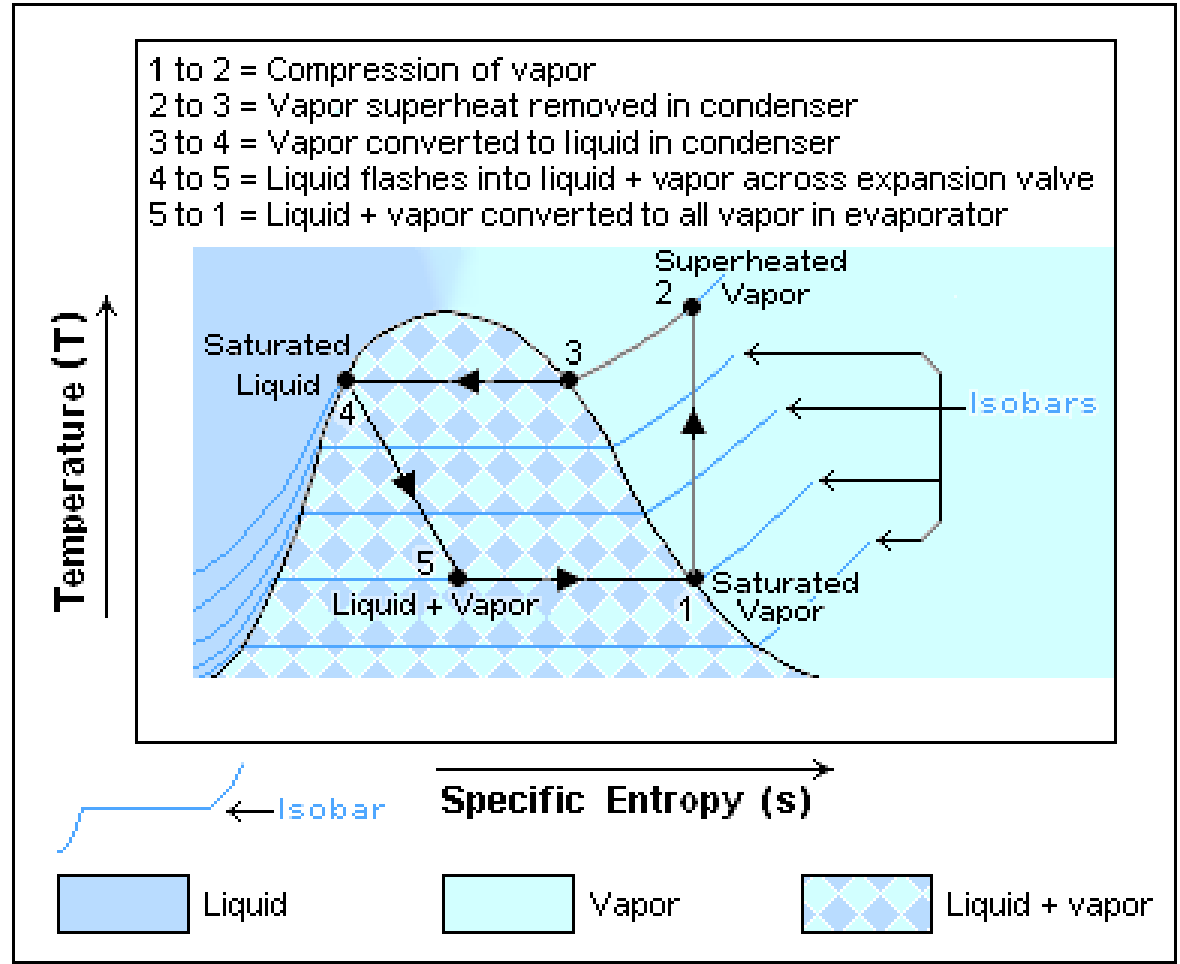
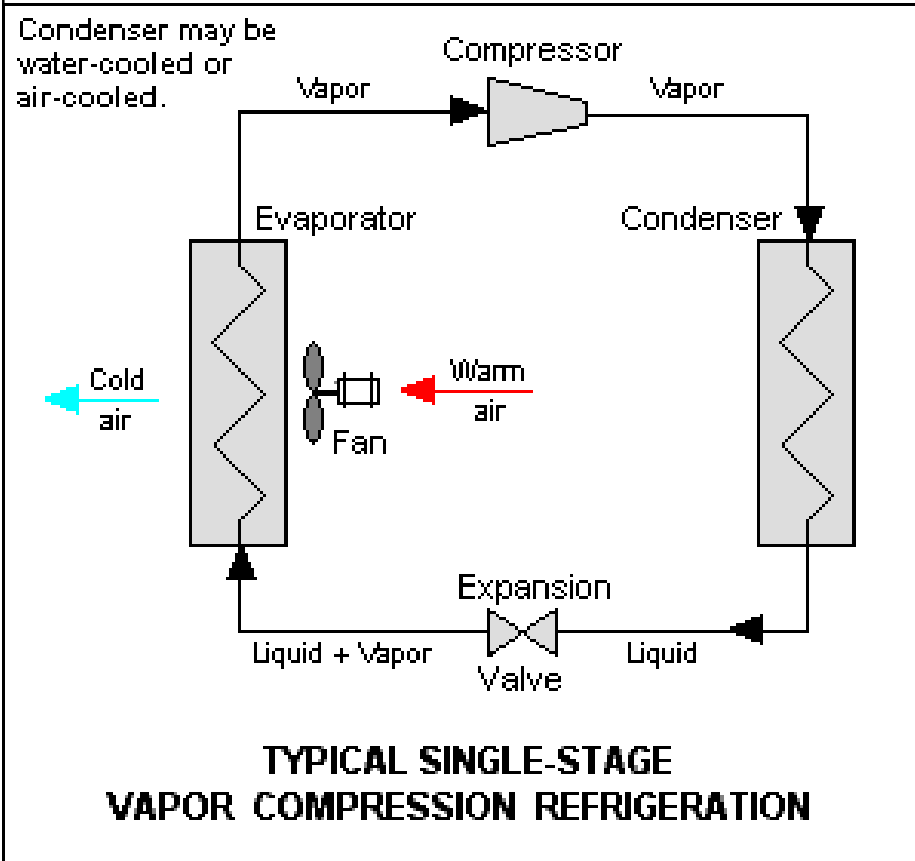

COP of a refrigerator = Cooling Effect/Work Input = $Q_L/W_{net,in}$

COP of a heat pump = Heating Effect/Work Input = $Q_H/W_{net,in}$

(Source: http://en.wikipedia.org/wiki/Heat_pump_and_refrigeration_cycle)

典型空調系統

Typical Air-conditioning Process

What is this A/C system called?

冷卻盤管具冷卻及抽濕功效
Cooling Coil for Cooling & Dehumidification

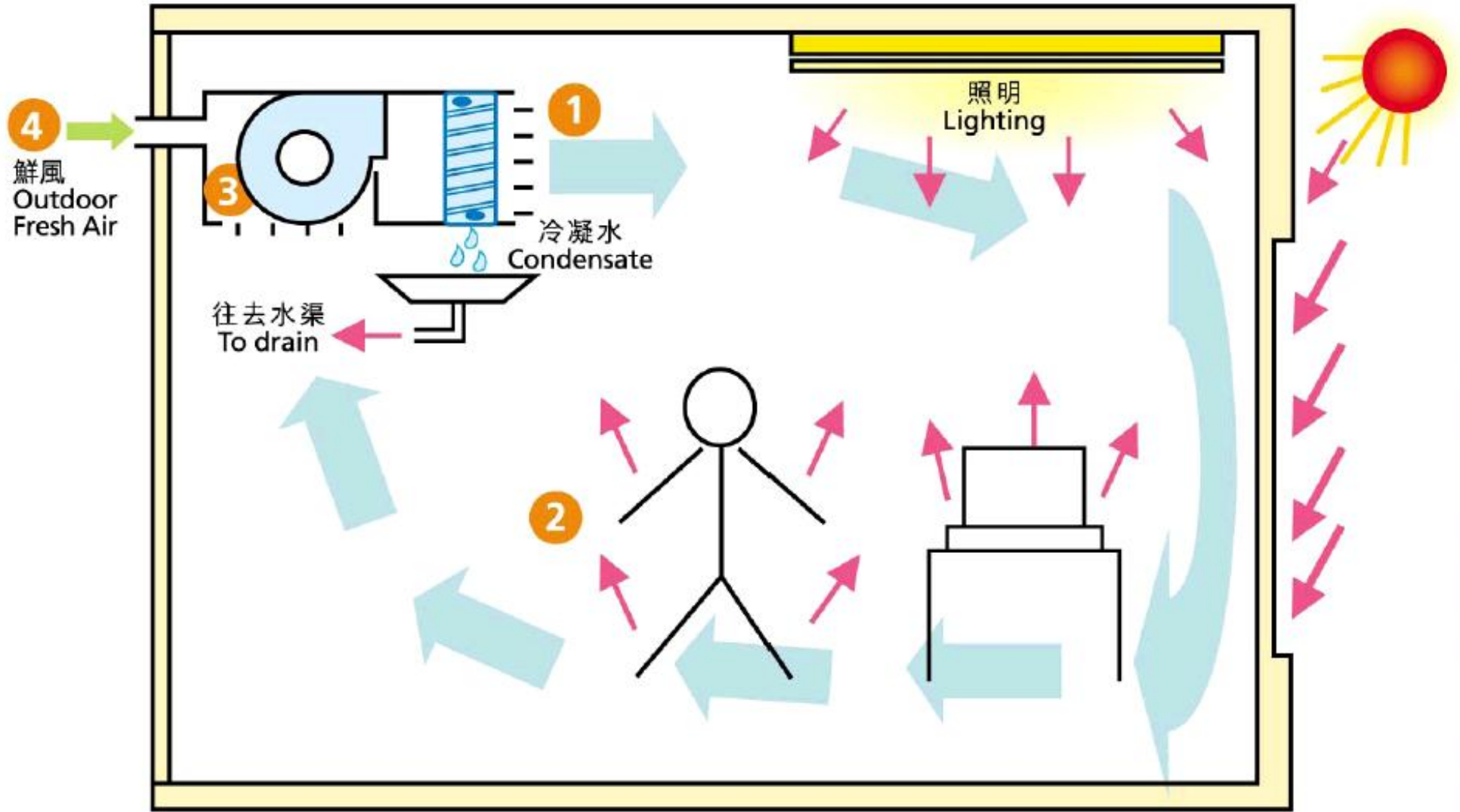

(Source: EnergyWitts newsletter, EMSD)

Chilled water cooling coil (a heat exchanger)

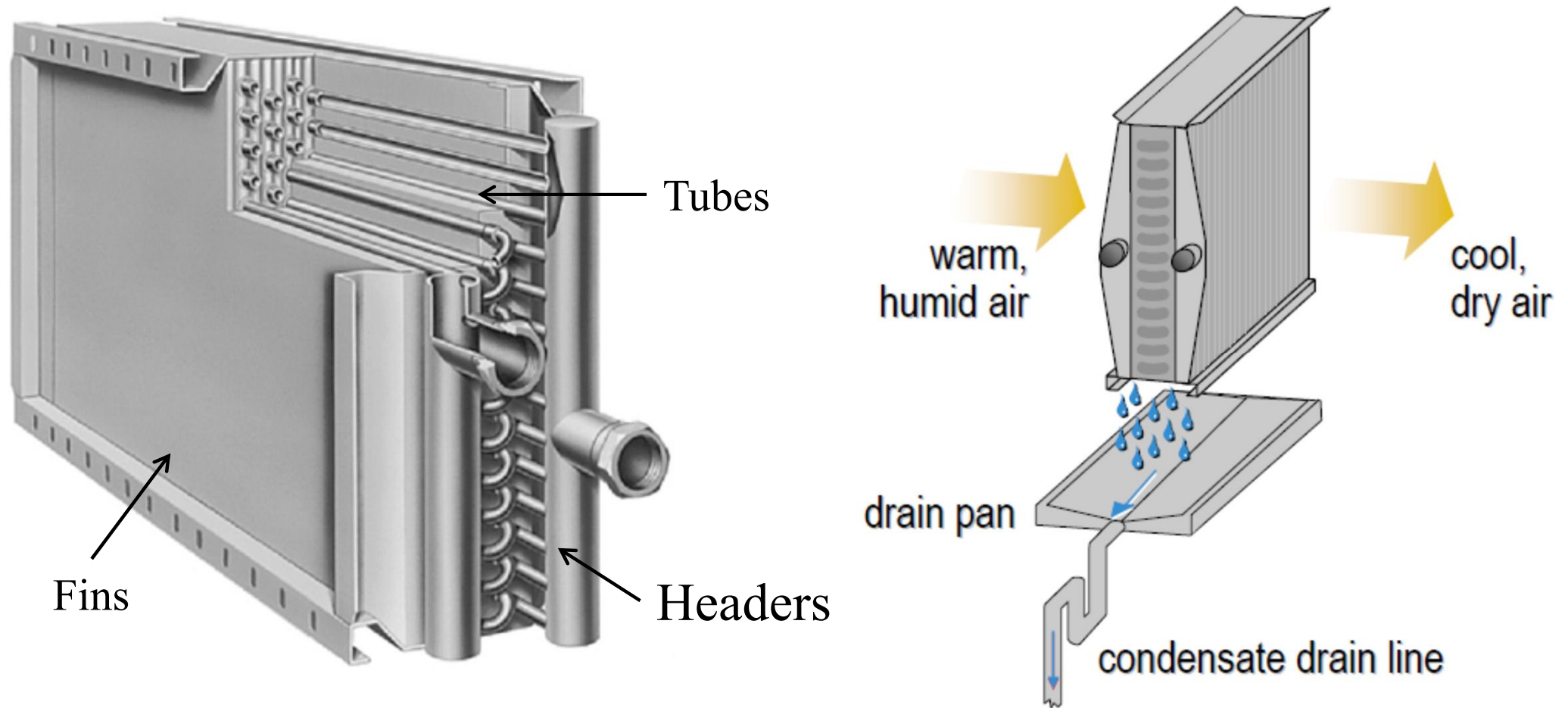

Sensible heat exchange: $q_S = m_a \times c_p \times (t_b - t_a)$

Latent heat exchange: $q_L = m_a \times h_{fg}$

Air Conditioning

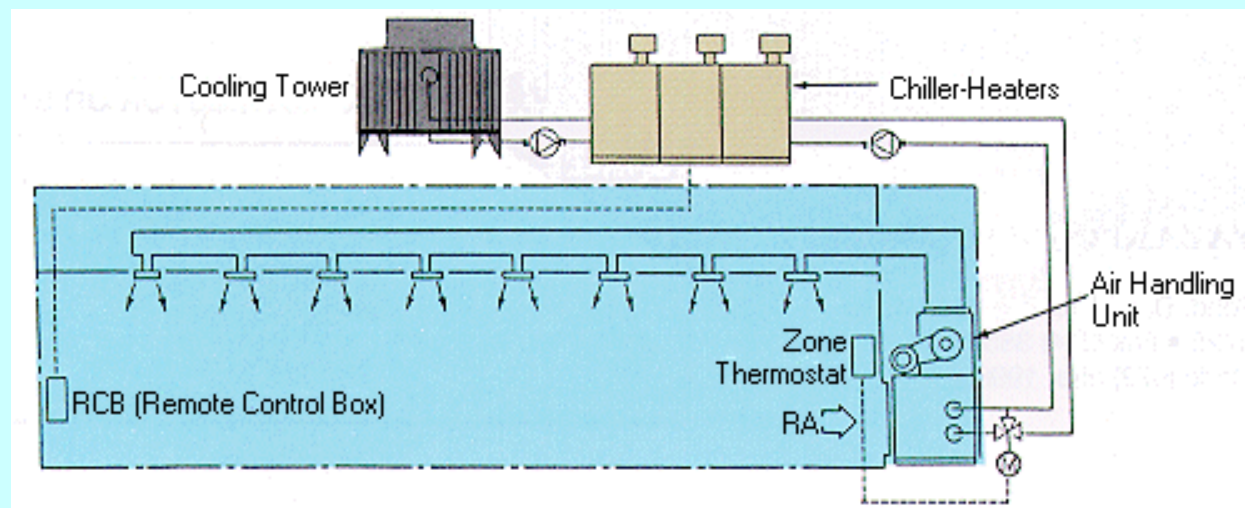
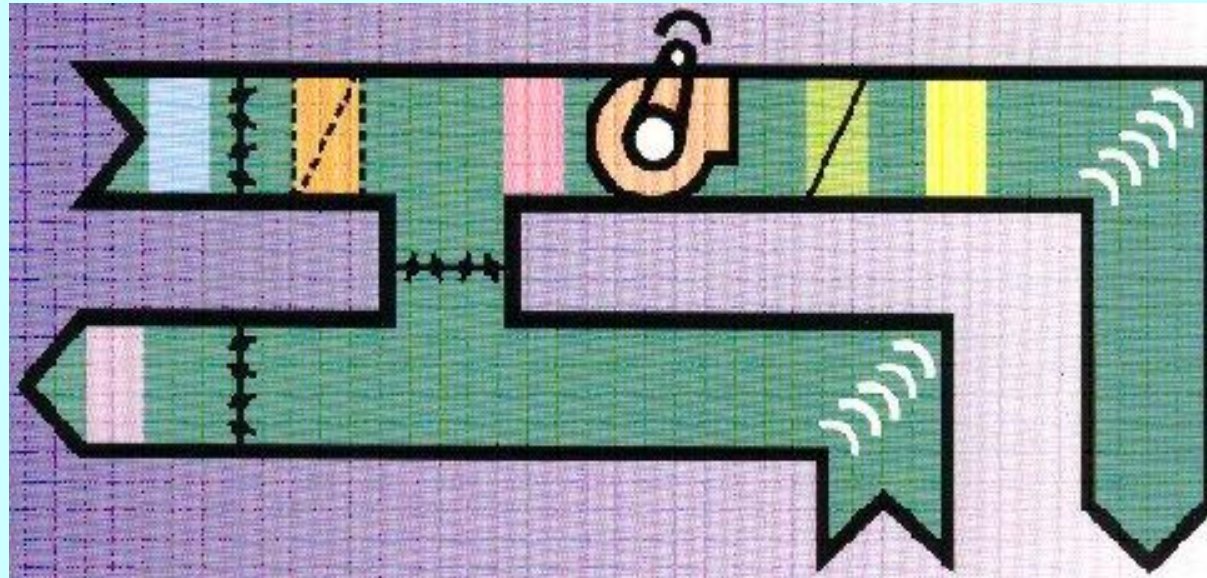



Air Conditioning

- The term “air conditioning” has gradually changed, from meaning just cooling to the total control of:
 - Temperature
 - Moisture in the air (humidity)
 - Supply of outside air for ventilation
 - Filtration of airborne particles
 - Air movement in the occupied space

“冷氣”



“空氣調節”
“空調”

Air Conditioning



- Definition (from ASHRAE*)
 - Air conditioning is the process of treating air so as to control simultaneously its temperature, humidity, cleanliness, and distribution to meet the requirements of the conditioned space.
 - Basic processes: Cooling and Heating
- Comfort cooling (air conditioning)
 - To meet comfort requirements of occupants

Air Conditioning



- Seven main air-conditioning processes:
 - 1. Heating (adding thermal energy)
 - 2. Cooling (removing thermal energy)
 - 3. Humidifying (adding moisture)
 - 4. Dehumidifying (removing moisture)
 - 5. Cleaning (removing particulates/contaminants)
 - 6. Ventilating (exchanging air between the outdoors and the conditioned space)
 - 7. Air Movement (circulating and mixing air)

History of refrigeration and air conditioning



Seasonal harvesting of snow and ice has begun earlier than 1000 B.C. (Store ice in winter for summer use), e.g. ice cellars of ancient Chinese



(Source: 5 Smart Ways to Keep Cool of Ancient Chinese
<http://www.chinawhisper.com/5-smart-ways-to-keep-cool-of-ancient-chinese/>)

Do you know ways to keep cool of ancient Chinese?

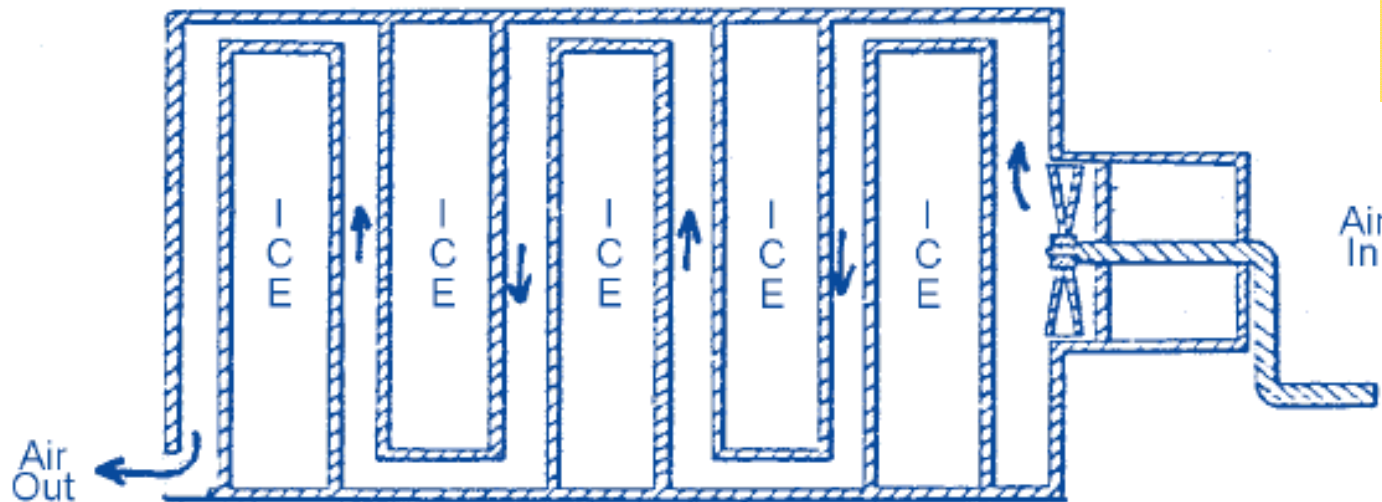

Figure 1: Shaler's patented cooler for ventilating air, 1865.

(Source: ASHRAE Journal, Feb 1999, https://www.ashrae.org/File%20Library/docLib/Public/200362710047_326.pdf)

- Ice cooling
- Evaporative cooling
- Ventilation (air flow)
- Porcelain pillows
- Salt solution cooling

Air Conditioning



- The History of Modern Air Conditioning

- http://www.air-conditioners-and-heaters.com/air_conditioning_history.html



- 1830: Dr. John Gorrie (ice for cooling hospital rooms)
 - 1881: James Garfield (device w/ melted ice water)
 - Late 19th century: “manufactured air” (controlling humidity in textile mills)
 - Early 1900s’: Willis Carrier (designed modern A/C systems for offices, apartments, hotels, hospitals)
 - 1917-1930: movie theatres were kept cool by A/C

Air Conditioning



- The Father of Modern Air Conditioning
 - Dr. Willis Haviland Carrier (1875-1950)



- Formed Carrier Air Conditioning Company (1907)
- Published a paper on rational psychrometric formulae in 1911
- Invented and patented many HVAC equipment
- Wrote a well-known air conditioning textbook

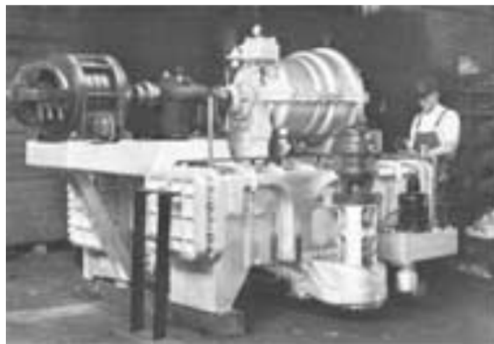

Air Conditioning



- Applications of air conditioning:
 - Industrial sector
 - e.g. textile mills, electronics, pharmaceutical
 - Commercial sector
 - e.g. offices, hotels, retails
 - Residential sector
 - e.g. apartments, houses
 - Transport sector
 - e.g. aircrafts, buses, private cars, trains



Air Conditioning



- Significance of air conditioning and refrigeration
 - No. 10 on the list of the [Greatest Engineering Achievements of the 20th Century]
 - <http://www.greatachievements.org>
 - These cooling technologies have altered some of our most fundamental patterns of living
 - Buildings are climate-controlled & comfortable
 - Fresh foods & milk are kept in refrigerators/freezers
 - Building designs are changed completely
 - Environment for industrial processes are controlled

Air Conditioning



- To understand better, air conditioning system can be divided into five subsystems or loops:
 - 1. Air-side
 - 2. Chilled water
 - 3. Refrigeration equipment
 - 4. Heat rejection
 - 5. Controls



33 °C, 28 °C

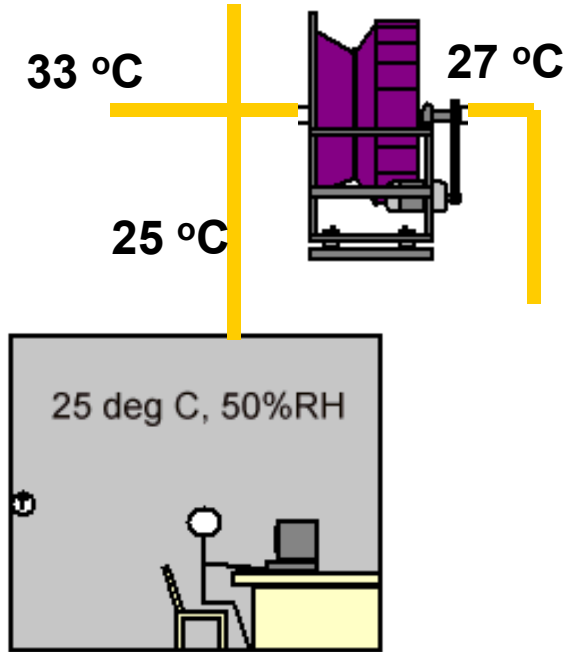

Conditioned space



33 °C, 28 °C

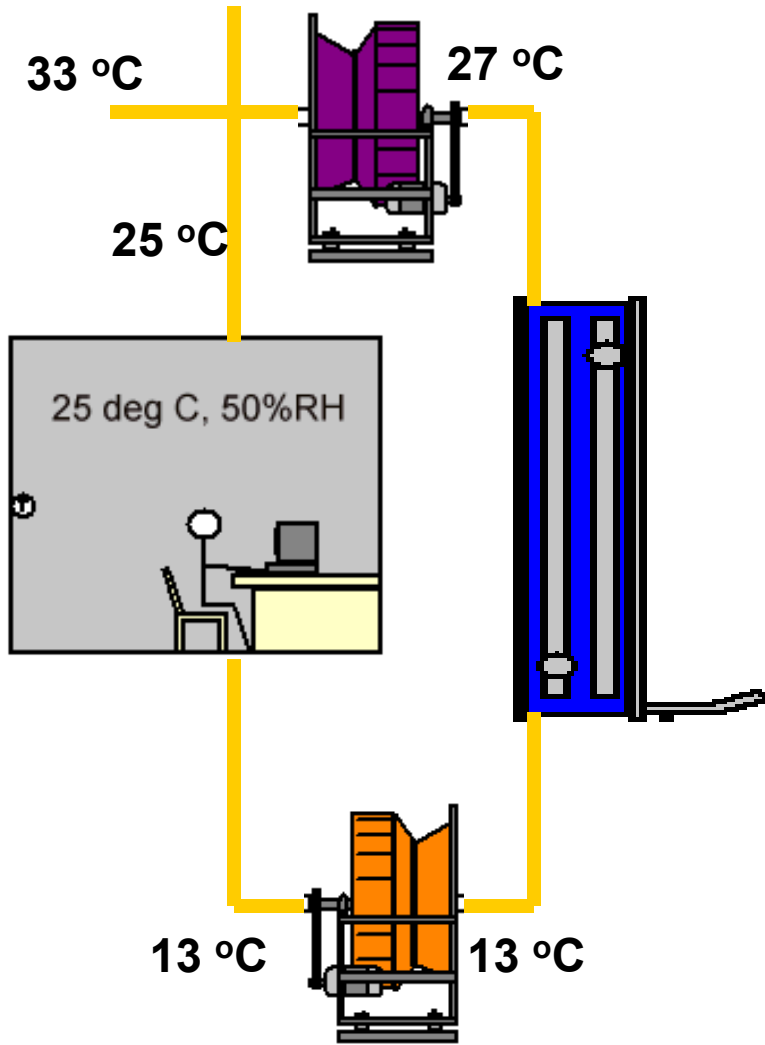

Air side system



33 °C, 28 °C

Chilled water system

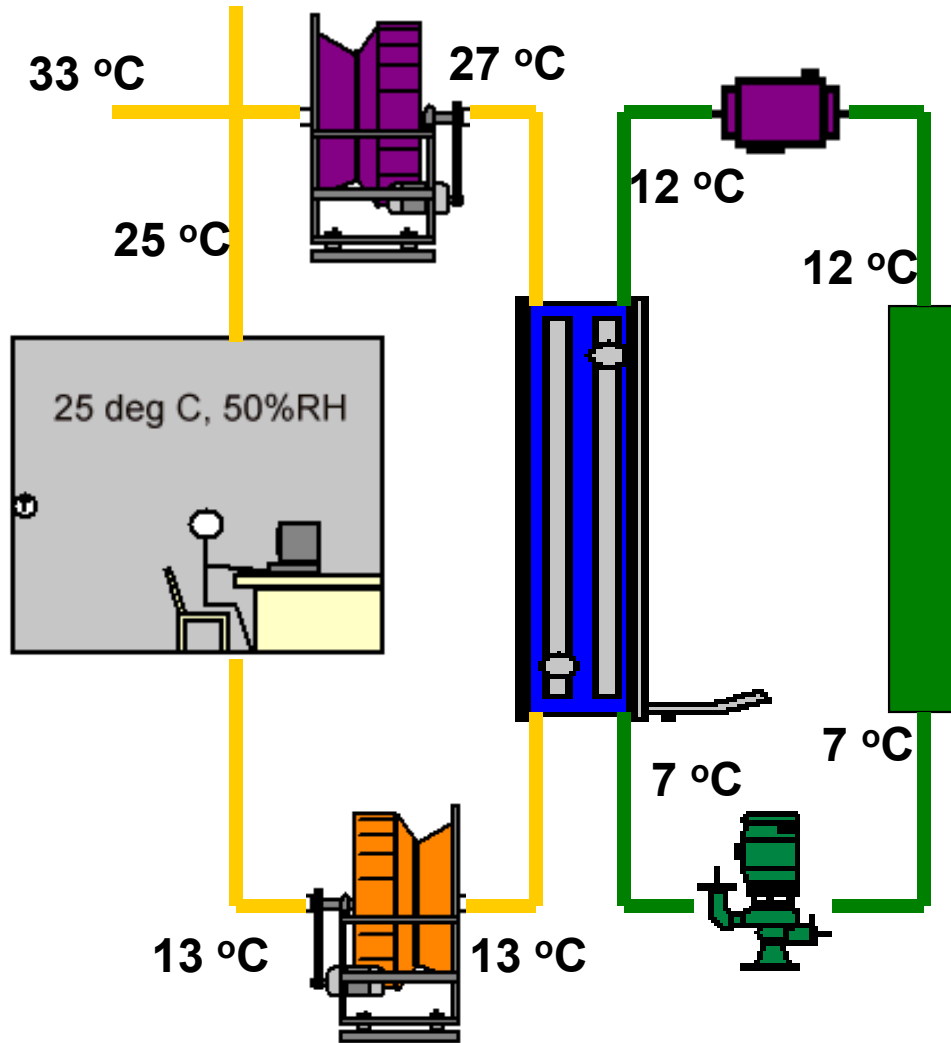



33 °C, 28 °C

Refrigeration equipment

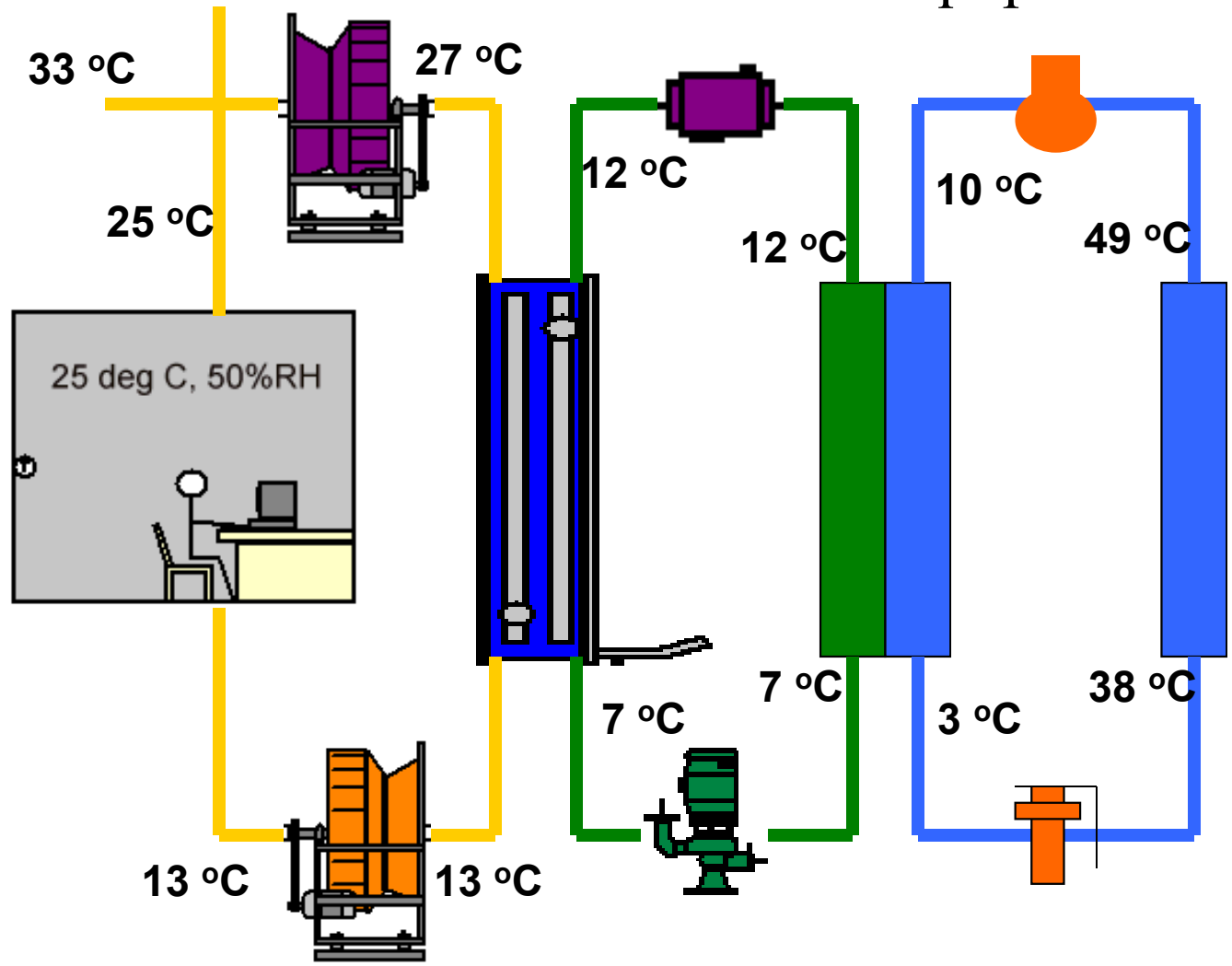



33 °C, 28 °C

Heat rejection

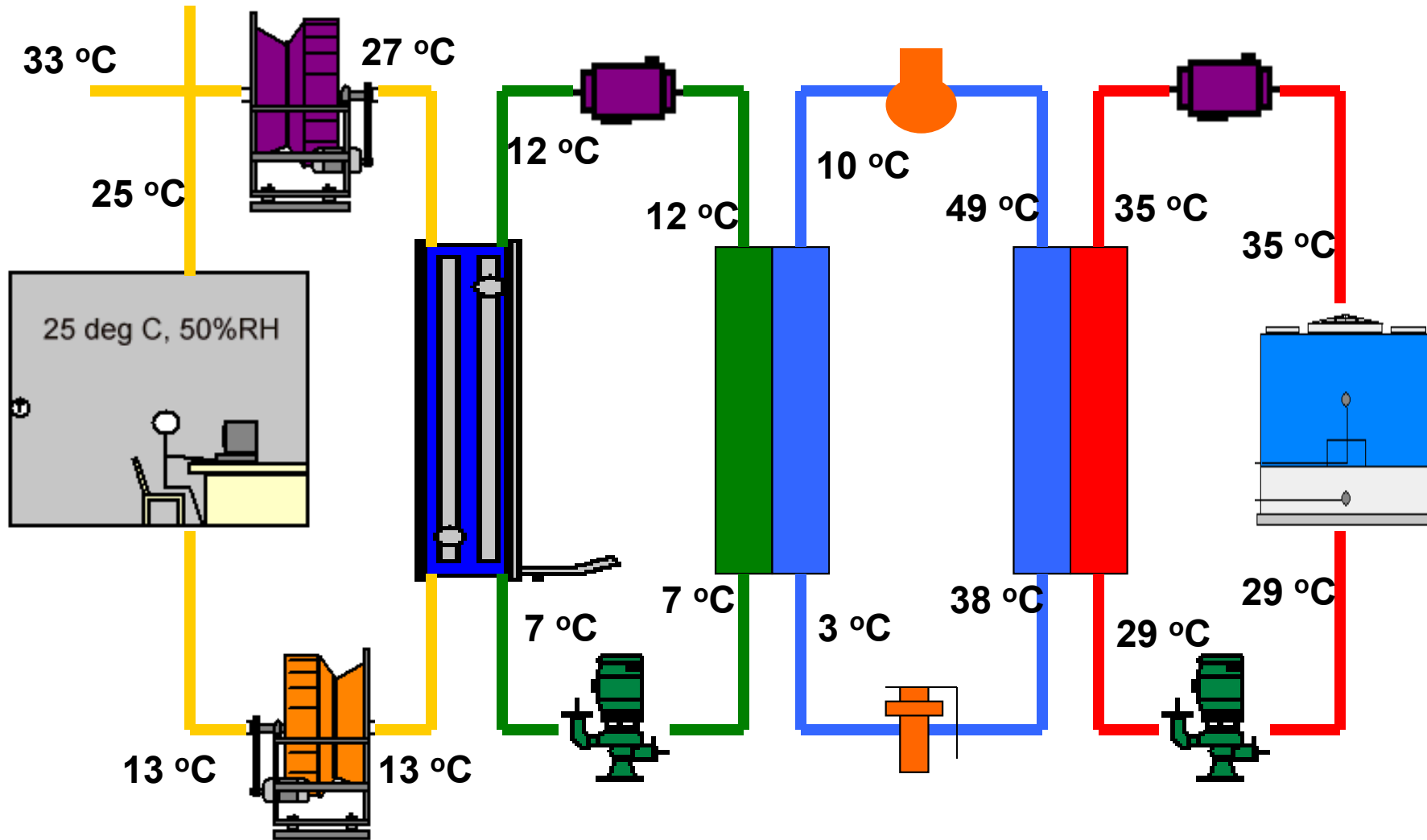



33 °C, 28 °C

Control Loop

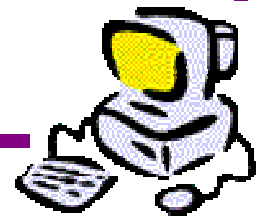
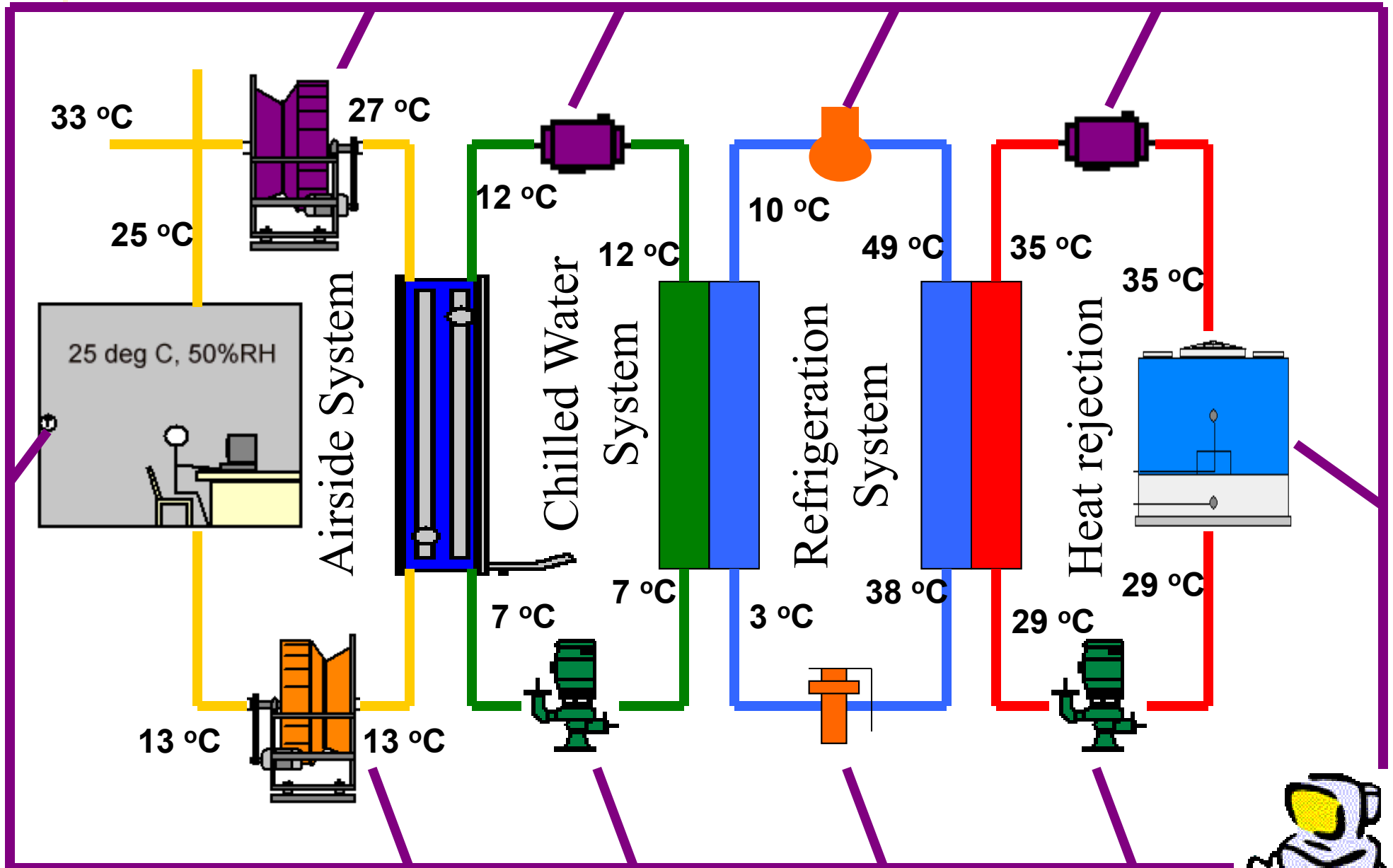



Design of HVAC Systems

- Classification of HVAC systems -- three generic types of systems:
 - Centralised all air systems
 - Such as CAV (constant air volume), VAV (variable air volume), dual duct, multizone
 - Partially centralised air/water systems
 - Such as FCU (fan coil unit), induction units
 - Local systems (mainly direct expansion systems)
 - Such as window-type units, split-type systems, VRF (variable refrigerant flow)(?)

Centralised air system (VAV example)

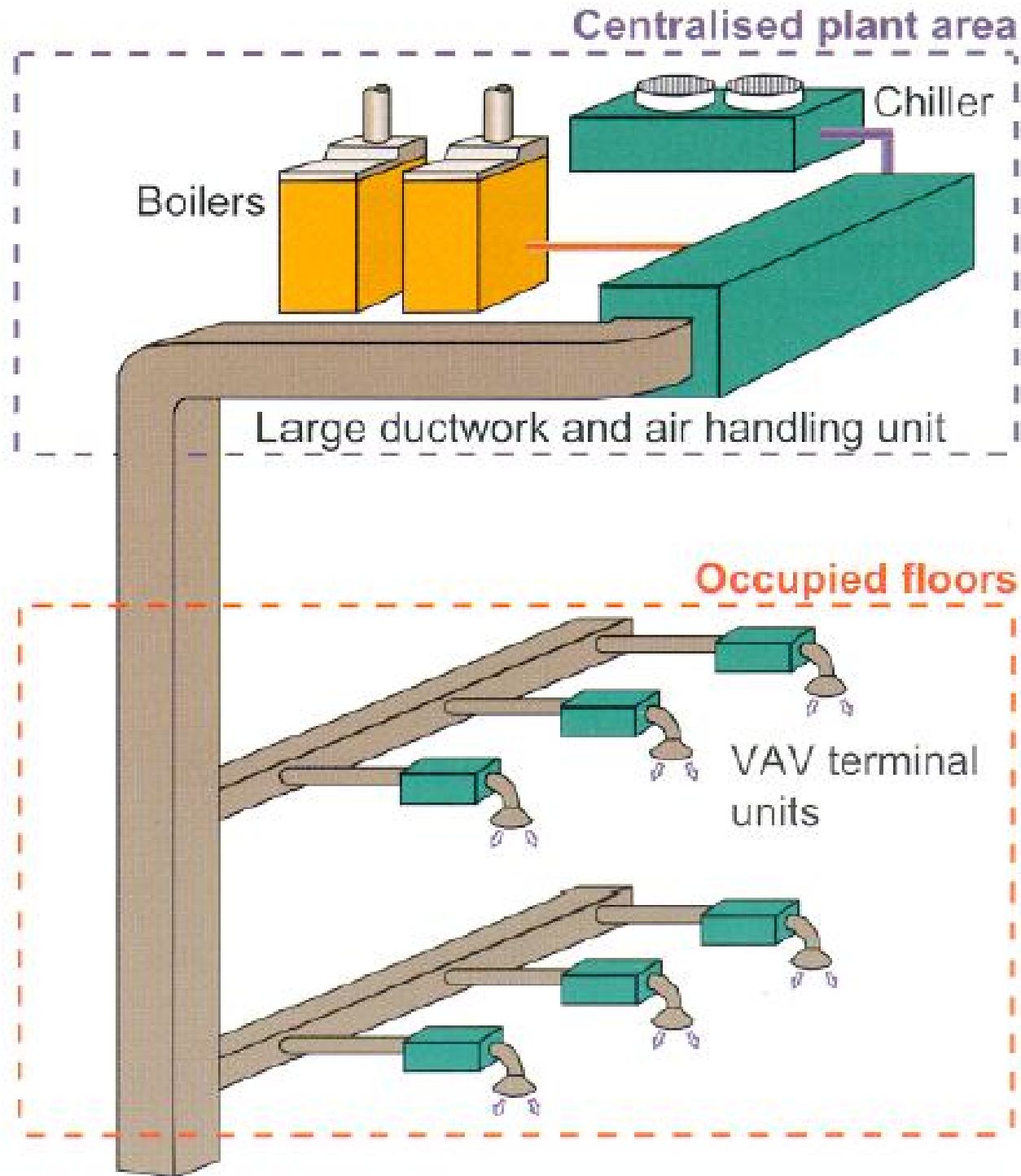

Partially centralised air/water system (Fan coil example)

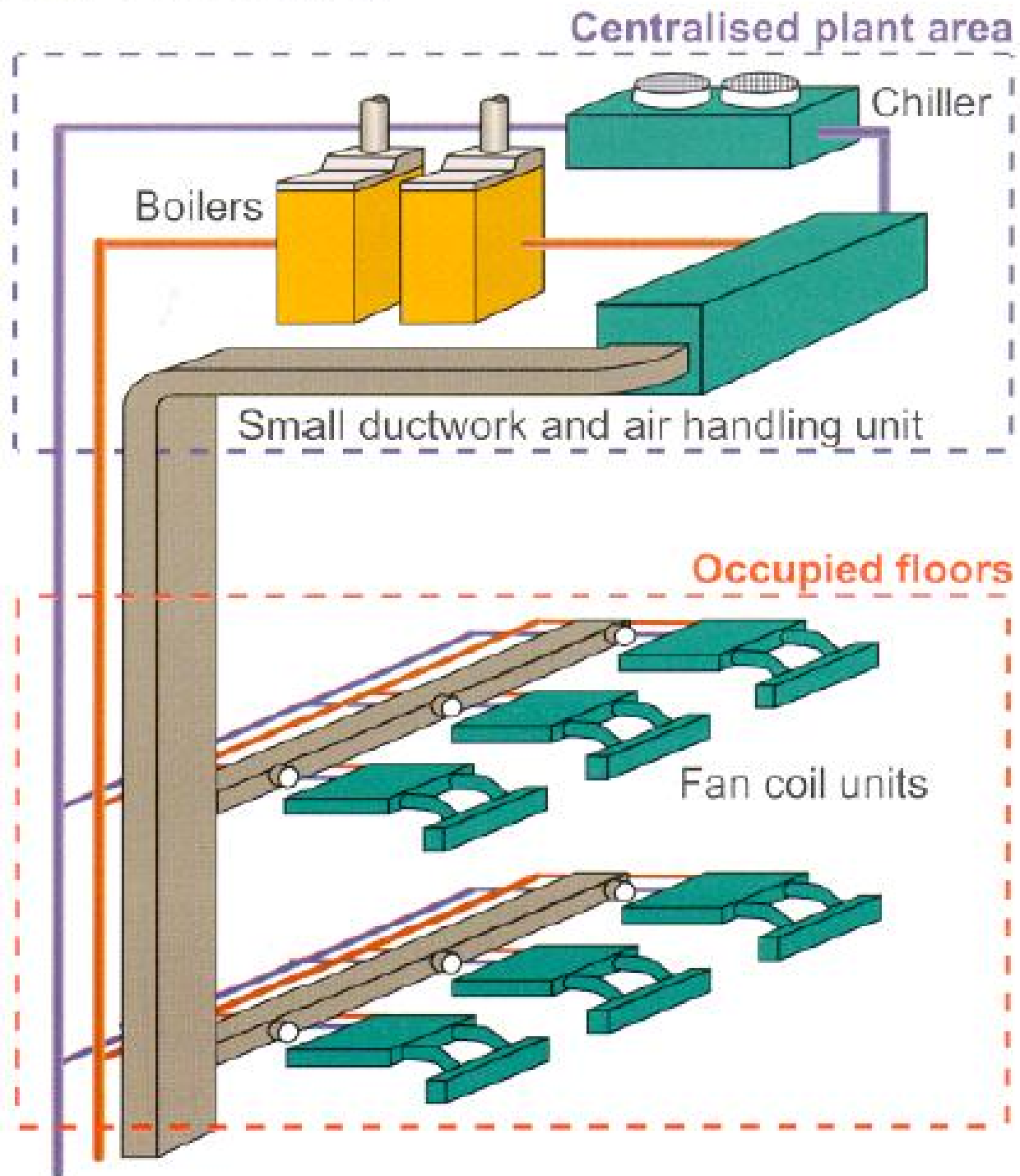

An individual room air-conditioning system

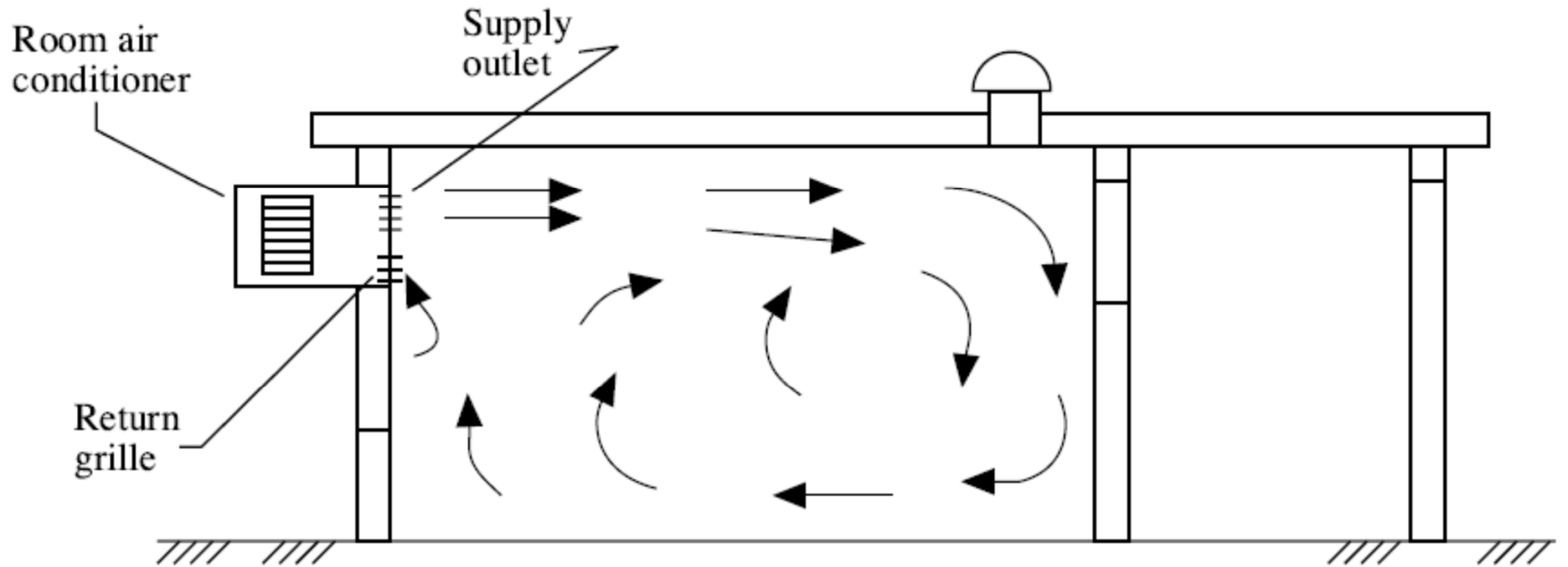

Primary air fan coil unit (PA-FCU) system

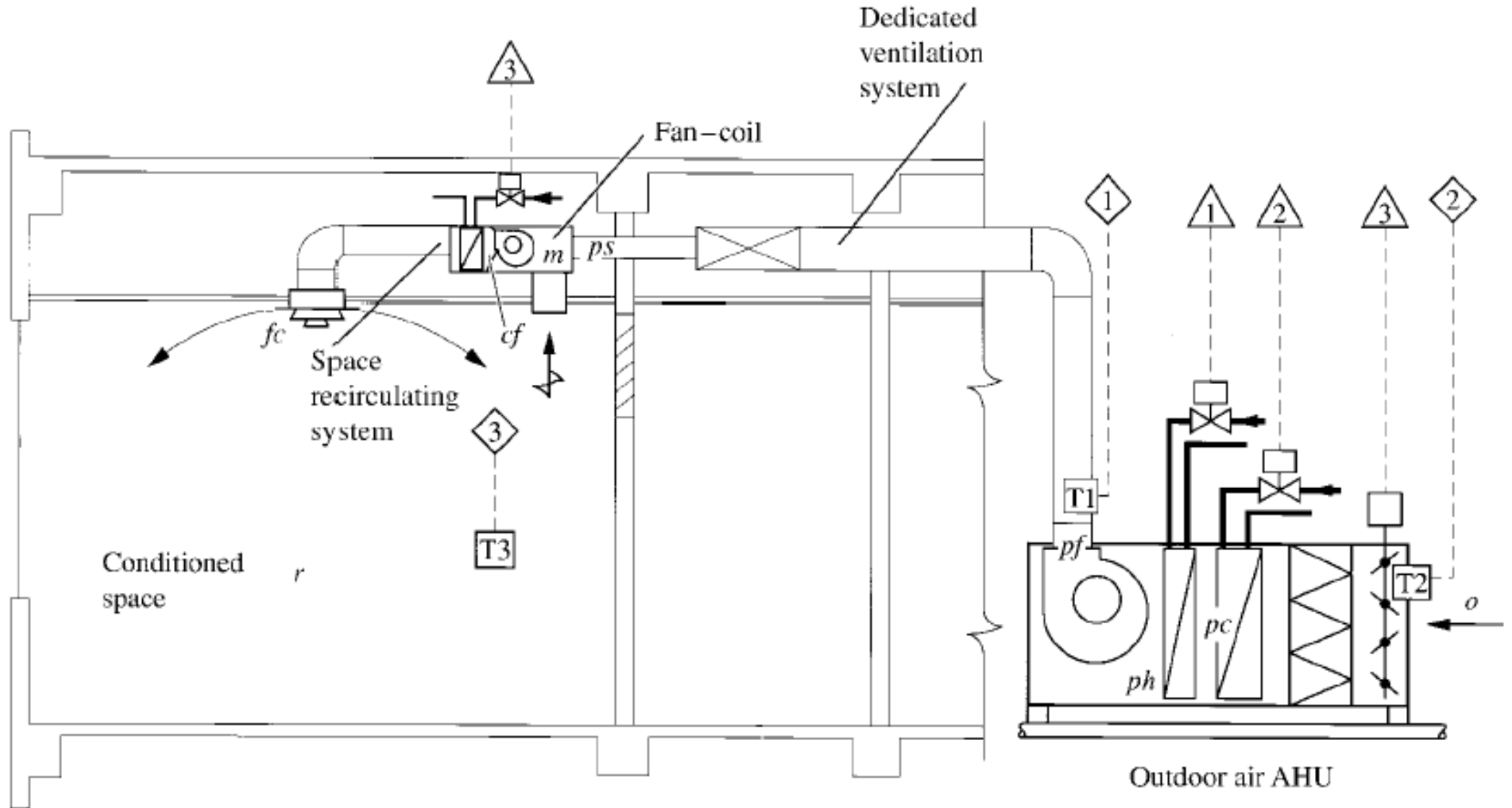

Variable refrigerant flow (VRF) system

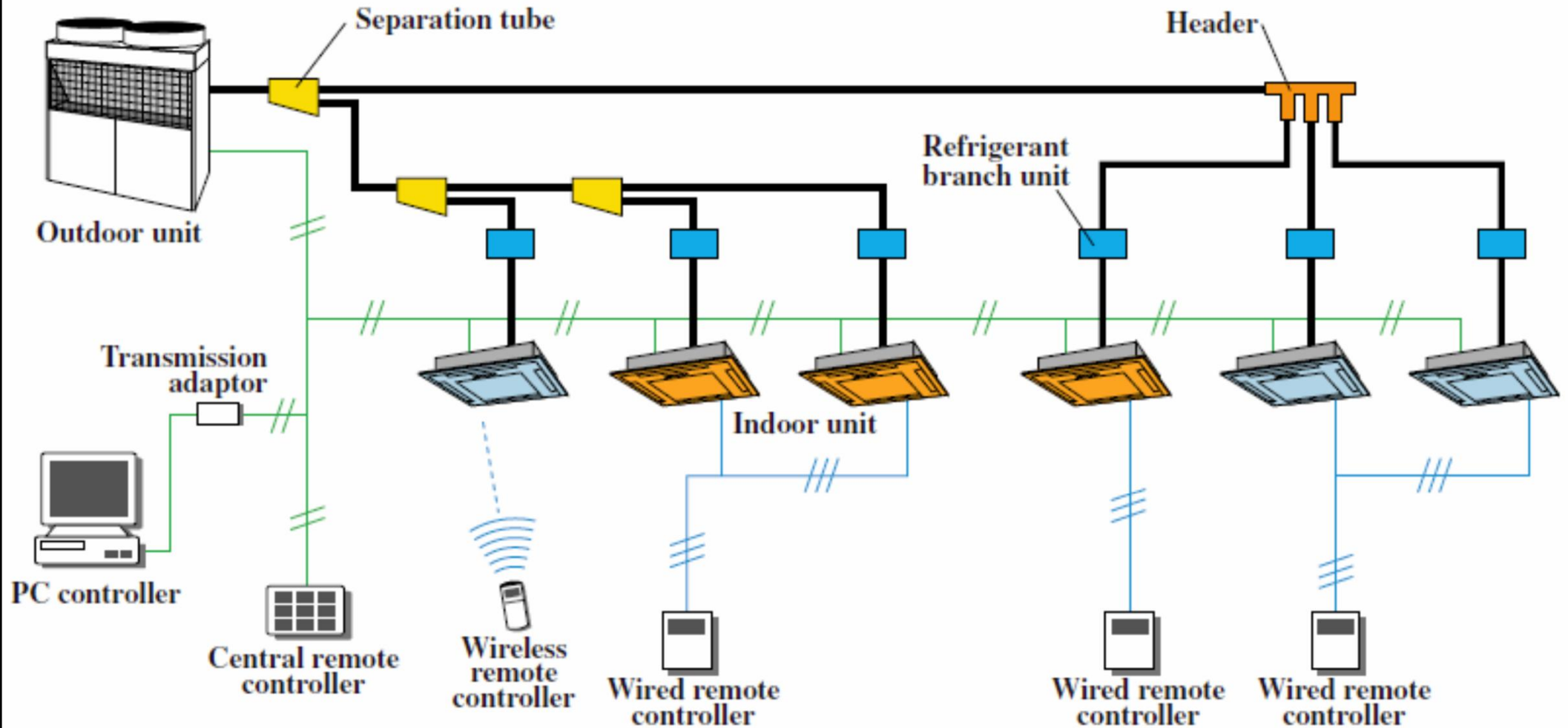

(Source: Fujitsu)

(See also: http://en.wikipedia.org/wiki/Variable_refrigerant_flow)

A space-conditioning air-conditioning system (fan-coil system)

Heat rejection

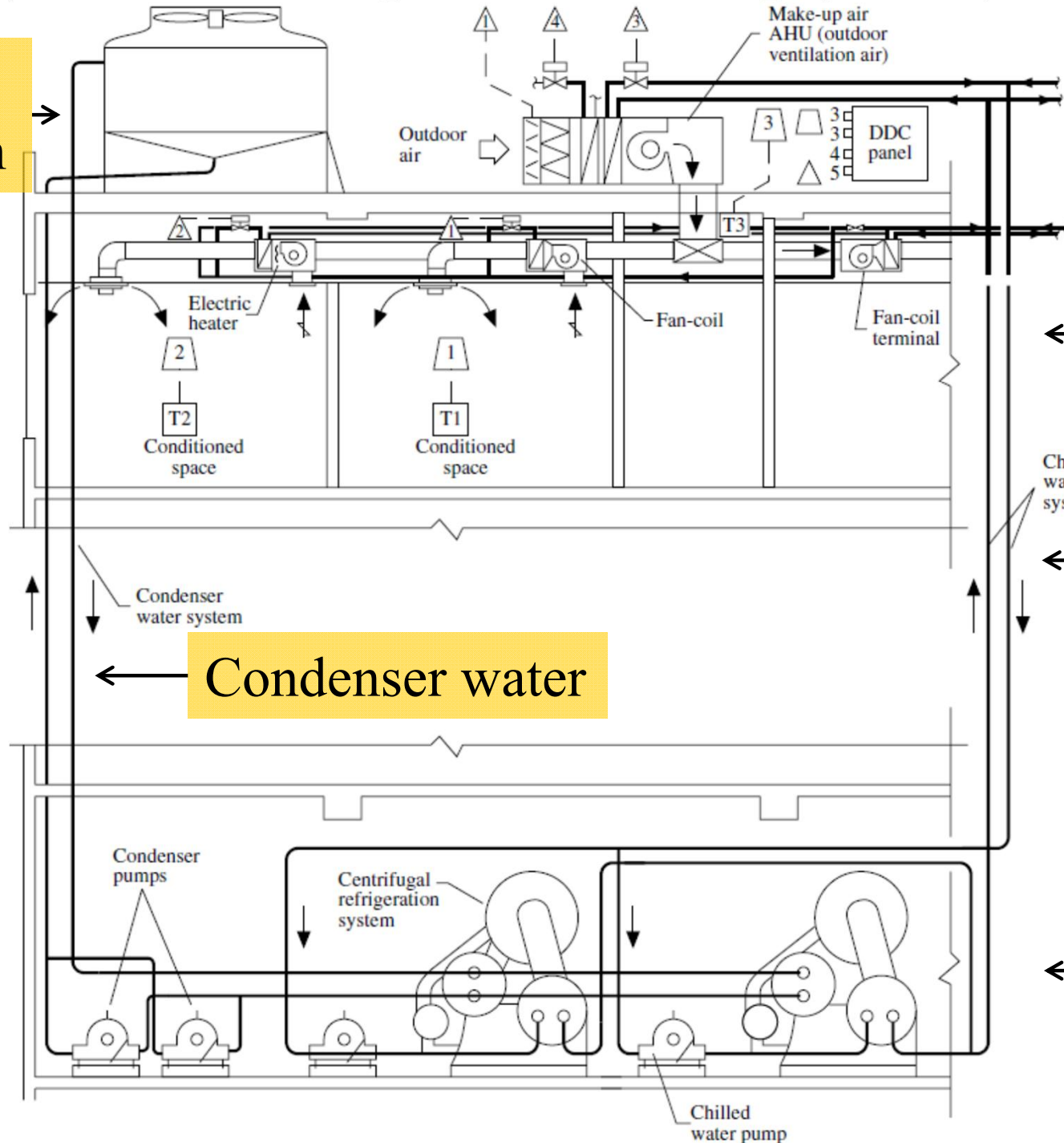

Air side

Chilled water

Condenser water

Refrigeration



Design of HVAC Systems

- Design of an HVAC system includes:
 - 1. Calculation of the maximum cooling and heating loads for the spaces to be served
 - 2. Selection of the type of system to be used
 - 3. Calculation of piping and/or duct sizes
 - 4. Selection of the type and size of equipment (chillers, boilers, fans, air handling units, heat exchangers, etc.)
 - 5. A layout of the system and schematic diagrams

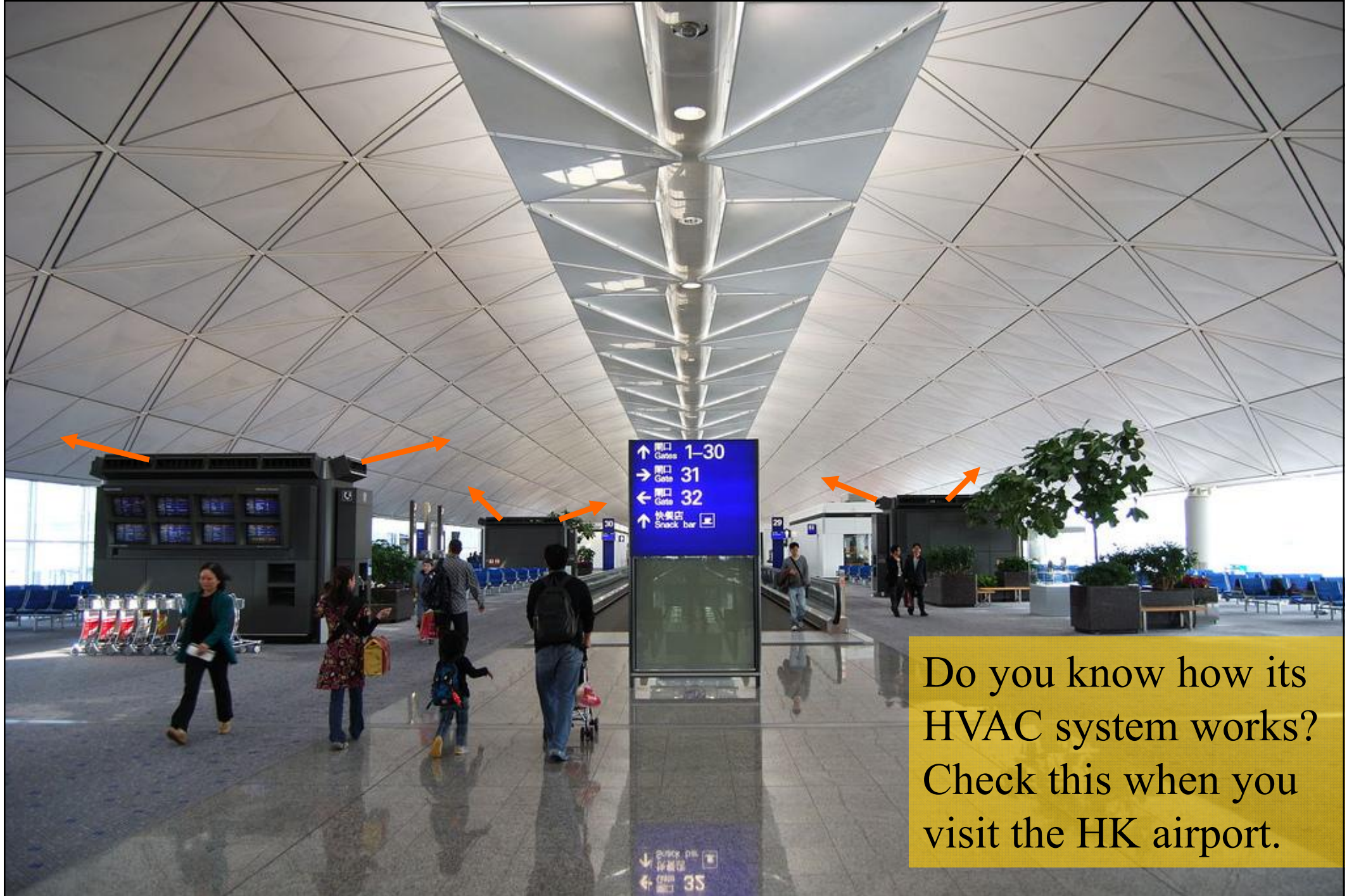

Do you know how its HVAC system works? Check this when you visit the HK airport.

Hong Kong International Airport

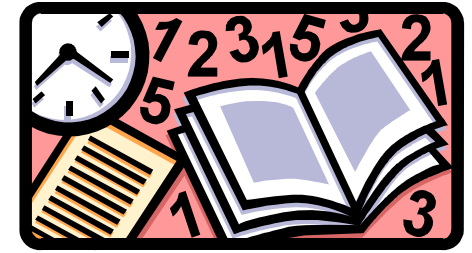

Further Reading

- Introduction to Air Conditioning
 - www.arca53.dsl.pipex.com/index_files/ac1.htm
- Videos:
 - Air Conditioning 1 - Introduction (0:47), <http://youtu.be/rUJjj6Fnhz4>
 - Air Conditioning 2 - Air Cycle (1:46), <http://youtu.be/nDUrjUgjADE>
 - Home Cooling System Design Issues (5:07), <http://youtu.be/3r1bMdFS4NA>
- Lesson 36 Selection Of Air Conditioning Systems
<http://nptel.ac.in/courses/112105129/36>

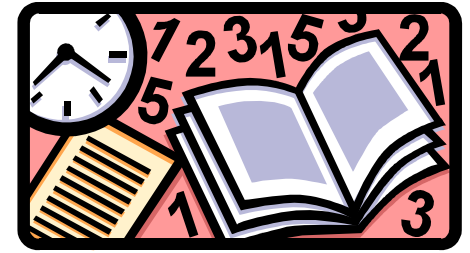

References

- Useful HVAC references:
 - Howell, R. H., Coad, W. J. and Sauer, H. J., 2013. *Principles of Heating, Ventilating, and Air Conditioning*, 7th ed., Chp. 1, American Society of Heating, Refrigerating and Air-Conditioning Engineers, Atlanta, GA.
 - Jones, W. P., 2001. *Air Conditioning Engineering*, 5th ed., Butterworth-Heinemann, Oxford & Boston.
 - Mcdowall, R., 2007. *Fundamentals of HVAC Systems*, SI edition, American Society of Heating, Refrigerating and Air-Conditioning Engineers Inc., Atlanta, GA.
- Further reading and learning materials: (online)
 - NPTEL E-learning course -- Refrigeration and Air Conditioning <http://nptel.ac.in/courses/112105129/>