



## Light Sources & Luminaires

*Ir Dr. Sam C. M. Hui*

E-mail: [sam.cmhui@gmail.com](mailto:sam.cmhui@gmail.com)

<http://ibse.hk/cmhui/>

# Contents



- Light sources
- Incandescent
- Fluorescent
- High intensity discharge (HID)
- Low pressure sodium
- Induction lamps
- Light emitting diode (LED)
- Luminaires

# Light sources

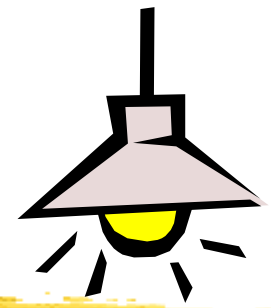

- Historical evolution of lighting
  - Natural light (the sun, daylight)
  - Torches (e.g. fire, wood + animal fat)
  - Candles & the wick
  - Gas lamps (e.g. street lighting)
  - Electric lamps
    - Incandescent light bulbs, fluorescent lights
    - Mercury-vapour & high intensity discharge lamps
    - Light emitting diode (LED) lighting

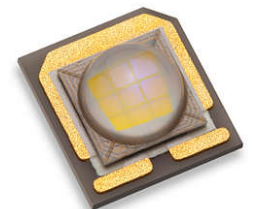

# Lighting history and light bulbs

## LIGHTING HISTORY

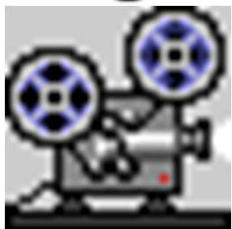
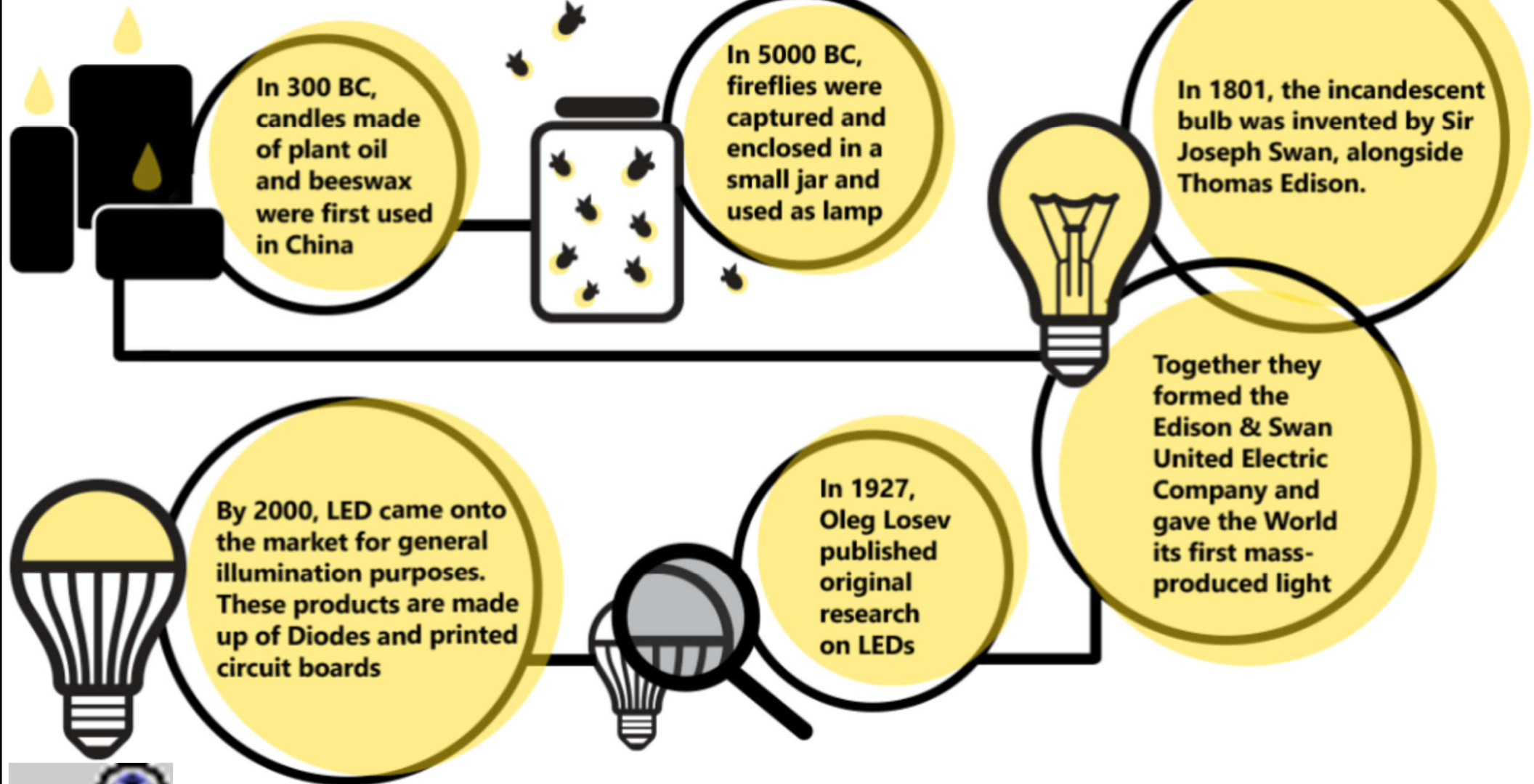

Video: Out of the Dark: The History of Lighting (2:16) <https://youtu.be/85wz-jVfa1U>

### Traditional incandescent

### Halogen incandescent

### Compact fluorescent (CFL)

### Light-emitting diode (LED)

Approximate wattage needed to produce 1,600 lumens

100 watts

77\* watts

23 watts

20 watts

INPUT  
OUTPUT

Wasted energy

1,600 lumens

Electric current heats an incandescent bulb's tungsten filament until it glows.



LIFE SPAN: 750 hours



PRICE: \$0.37 per bulb



1,600 lumens

Halogen gas such as iodine inside the bulb prevents wear on the filament, allowing it to glow brighter.



1,000 hours



\$1.59 per bulb



1,600 lumens

Excited gas in a CFL tube emits ultraviolet photons, which coax the bulb's coating to emit visible light.



10,000 hours



\$2.23 per bulb



1,600 lumens

An LED bulb contains many small semiconductor units; each emits light when a voltage is applied.



20,000 hours



\$45 per bulb



# The evolution of electric lighting

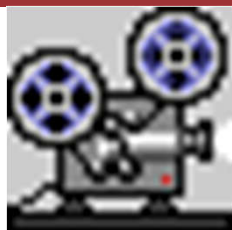
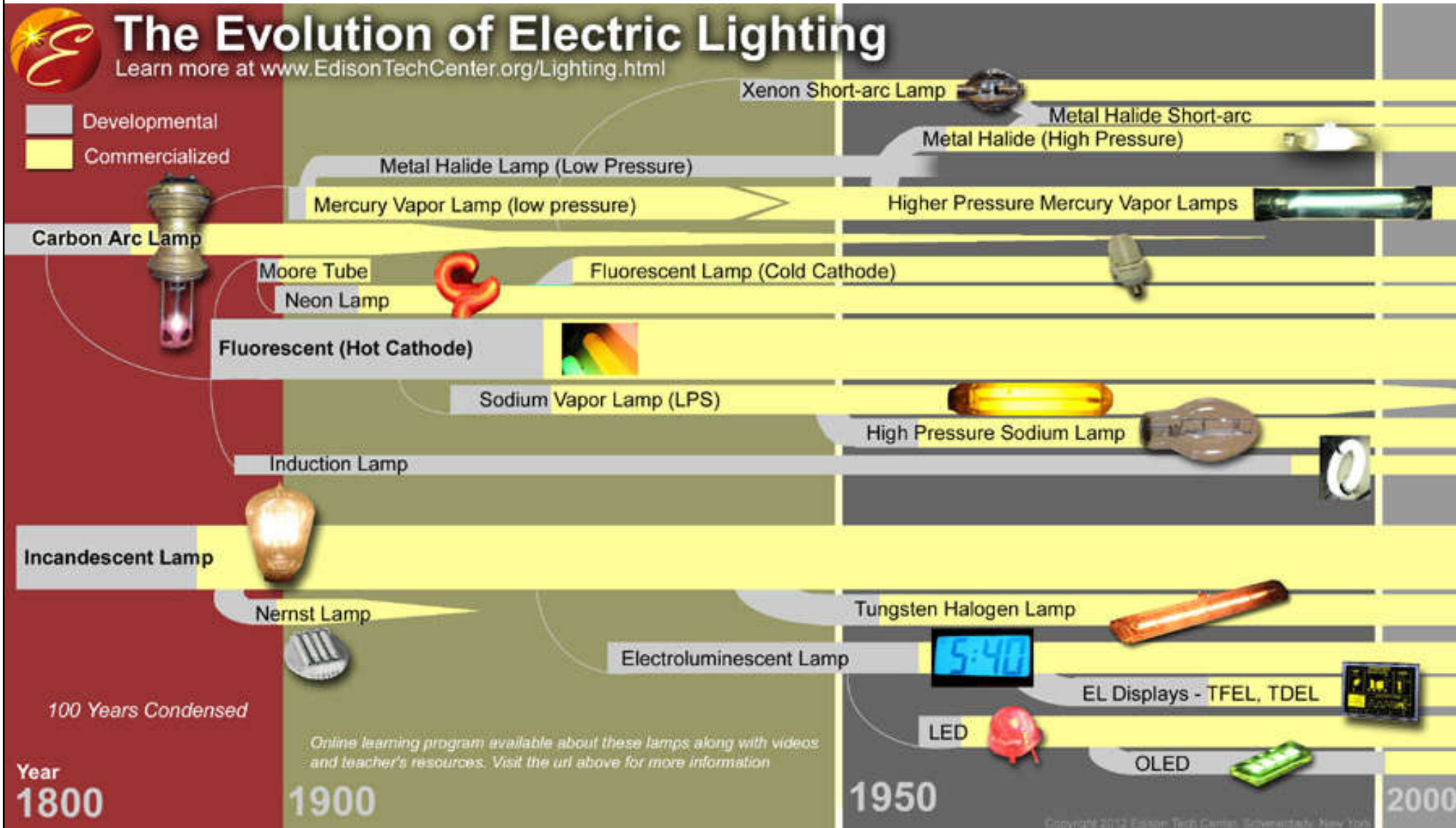

Video: Evolution of Light Bulbs, inventions - 2020 | History of Lighting, Documentary video (7:36) [https://youtu.be/uszG5FD1\\_Uw](https://youtu.be/uszG5FD1_Uw)

(Source: <https://edisontechcenter.org/Lighting.html>)

# Light sources

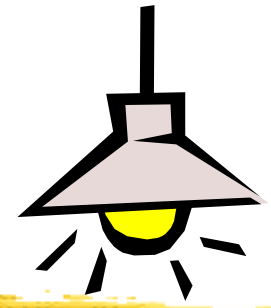

- Mechanism for production of light radiation:

- Incandescence
- Electric discharges
- Electroluminescence
- Luminescence
- Radioluminescence
- Cathodoluminescence
- Chemiluminescence
- Thermoluminescence

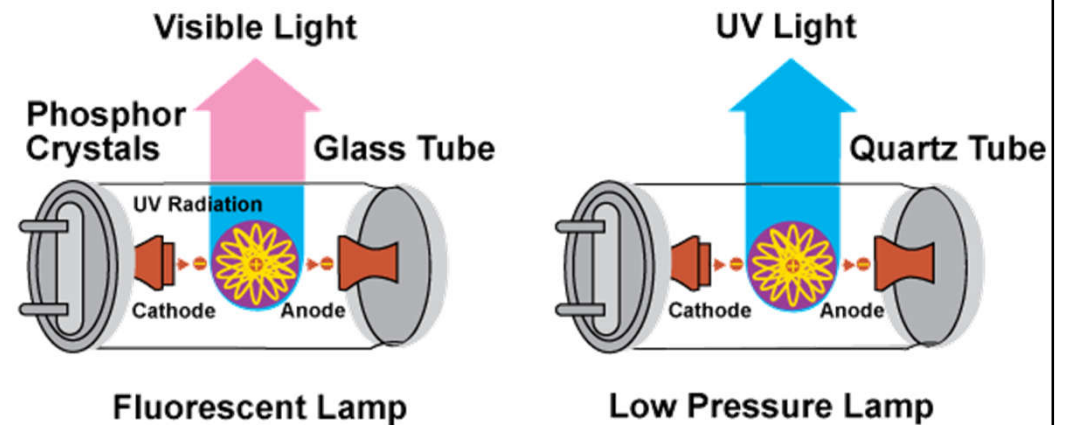

# Light sources grouped according to the technology employed

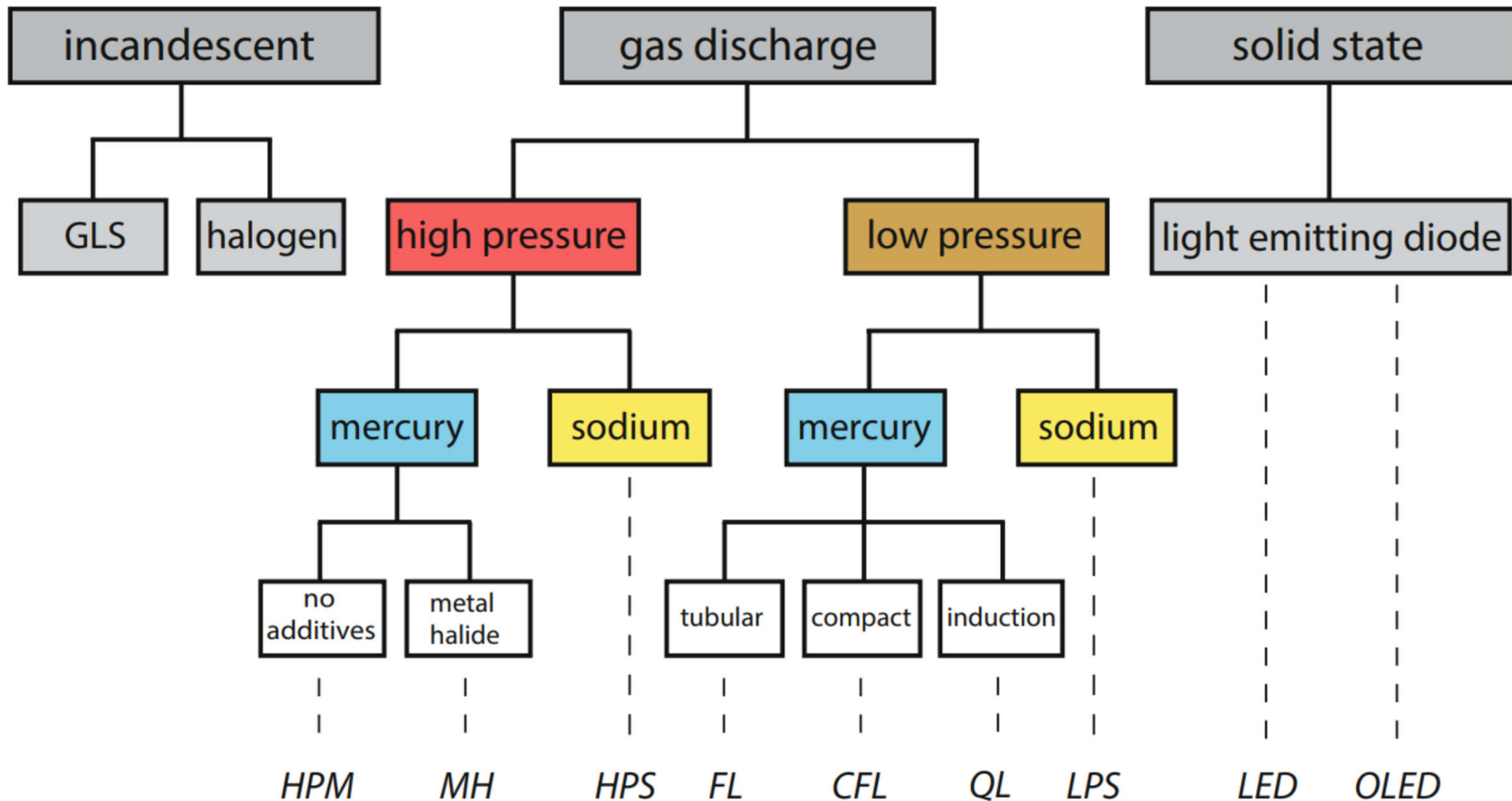

*HPM* = high-pressure mercury lamp, *MH* = metal-halide lamp, *GLS* = general lighting service incandescent lamp, *HPS* = high-pressure sodium lamp, *FL* = tubular fluorescent lamp, *CFL* = compact fluorescent lamp, *QL* = induction lamp, *LPS* = low-pressure sodium lamp, *LED* = light-emitting diode, *OLED* = organic light emitting diode



# Light sources

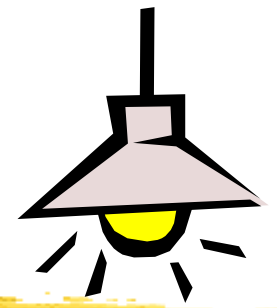

- Commonly used light sources (abbrev./code)
  - Incandescent filament (I or GLS = general lighting service)

- Tungsten-halogen (TH or H)

- Fluorescent (F)

- High intensity discharge (HID)

- Metal halide (MH or MBI or M)

- Mercury vapour (MBF or HPMV or Q)

- High pressure sodium (HPS or S or SON)

- Low pressure sodium (LPS or LS or SOX)

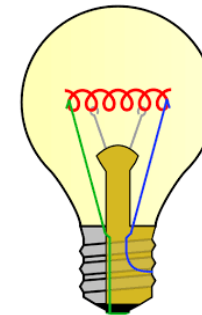

# Light sources

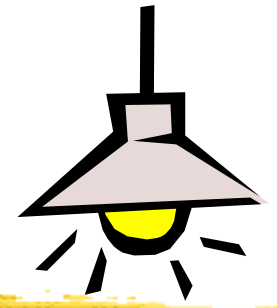

- Other light sources

- Induction lamps
- Light emitting diodes (LEDs)
- Electroluminescent lamps
- Lasers
- Combustion sources
  - Candle flame
  - Gas light (e.g. using kerosene)



(\* See also [http://en.wikipedia.org/wiki/List\\_of\\_light\\_sources](http://en.wikipedia.org/wiki/List_of_light_sources))

# Spectra from common sources of visible light

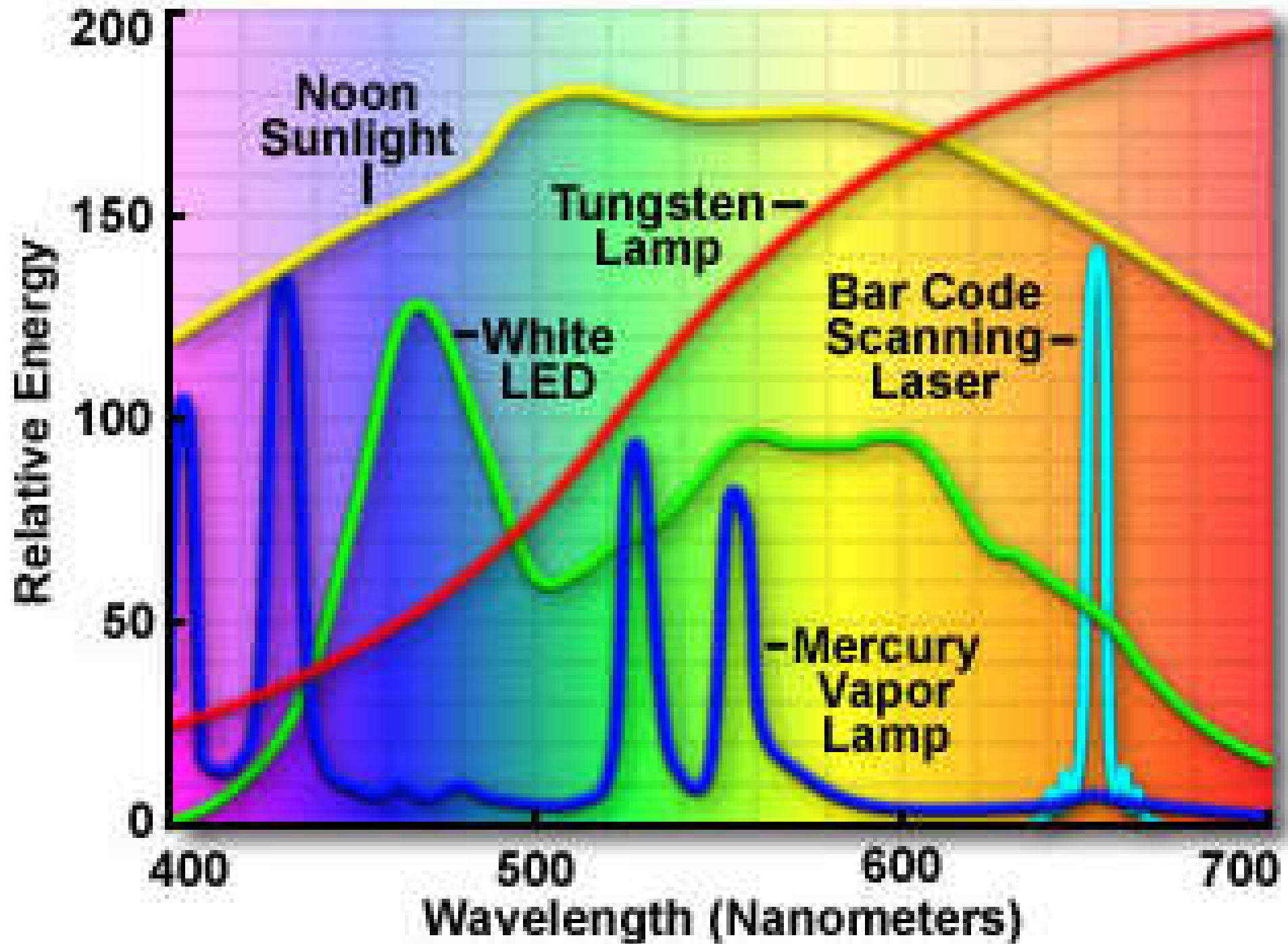

# Light sources

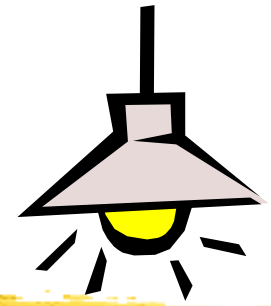

- 10 principal families of lamps (according to the manner of light emission) [*CIBSE/SLL Lighting Code*]
  - 1. Tungsten filament
  - 2. Tungsten halogen
  - 3. Metal halide
  - 4. Low pressure mercury (fluorescent)
  - 5. High pressure mercury
  - 6. Compact fluorescent (CFL)
  - 7. Low pressure sodium
  - 8. High pressure sodium
  - 9. Light emitting diodes (LED)
  - 10. Induction (mercury, sodium & sulphur)



# Important characteristics of lamps & light sources in interior lighting

Luminous efficacy (Lm/W)	Colour rendering (Ra)
Lumen package (Lm)	Luminance
Lamp price	Shape and dimensions
Lifetime (h)	Need of gear/driver (yes/no)
Lamp-lumen depreciation (Lx)	Run-up and reignition
Spectrum	Dimmable (yes/no)
Correlated colour temperature (CCT)	Ambient temperature sensitivity
Colour rendering	Environmentally unfriendly material

Lamp type	Lm/W	CCT	R <sub>a</sub>	Lifetime (h)	Shape
Incandescent lamp	8–12	2700	100	1000	Compact
Halogen lamp	15–25	3000	100	2000	Very compact
Tubular fluorescent	70–105	2700–17,000	60–90	15,000–20,000	Long linear
Compact fluorescent CFL	70–80	2700–5000	60–90	12,000–20,000	Compact
Induction lamp	65–75	3000–4000	60–90	60,000–75,000	Compact
Compact metal- halide	70–95	2700–4500	70–95	7000–12,000	Compact
Single LED (white)	80–180	2700–10,000	60–95	20,000–100,000	Point source
LED system (white)	70–160	2700–10,000	60–95	20,000–100,000	Many shapes, compact to large
OLED (white)	40–80	2700–6000	60–95	10,000–40,000	Flat, up to 50 × 50 cm

(Source: van Bommel W., 2019. *Interior Lighting: Fundamentals, Technology and Application*, Springer International Publishing, Cham.)

# Trends in luminous efficacy of lamps

(Source: LampTech,  
<http://www.lamptech.co.uk/>)

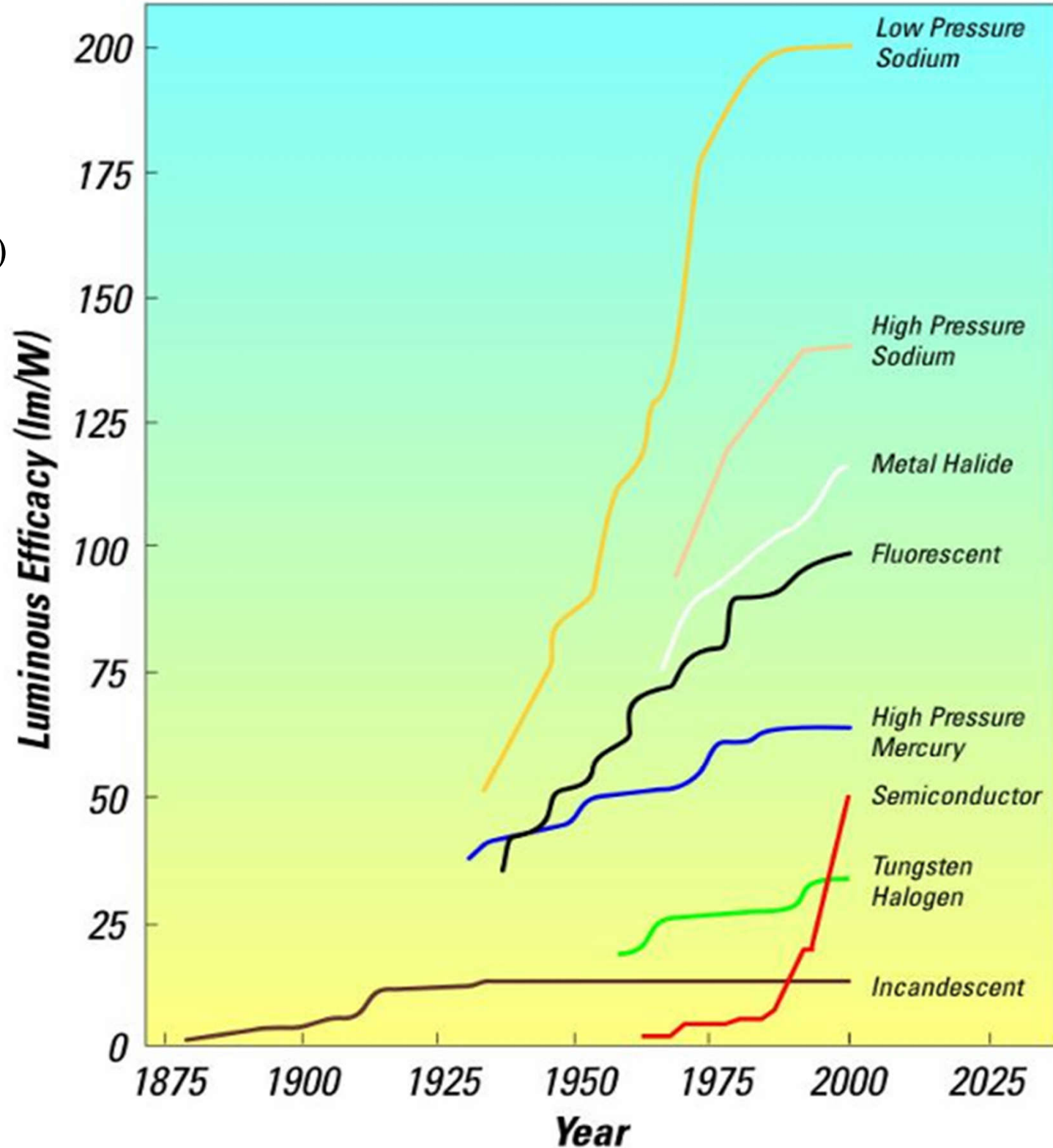

# Historical and predicted luminous efficacy of light sources

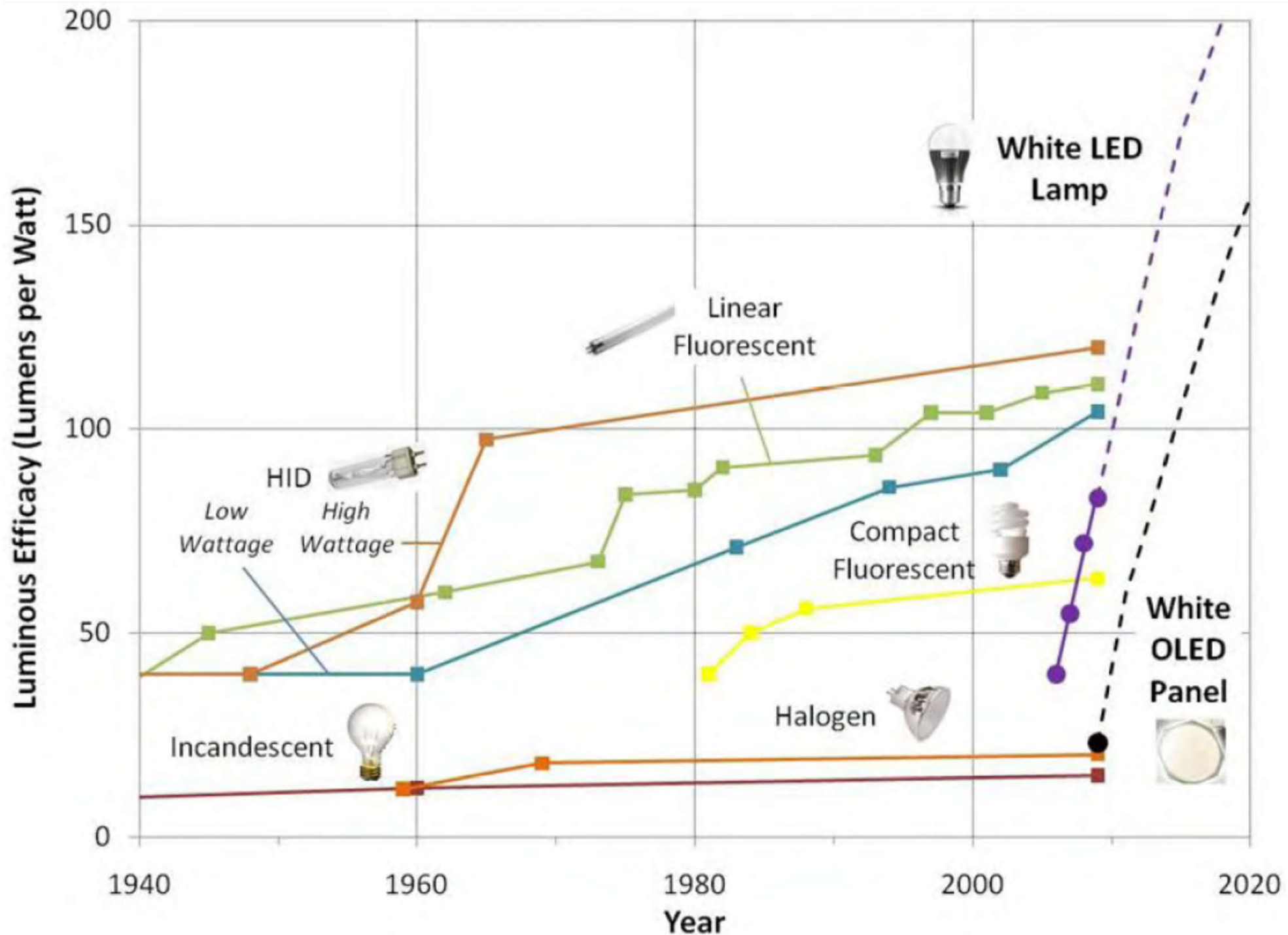

(Source: US Department of Energy)

# Inventors of the modern incandescent lamp 白熾燈

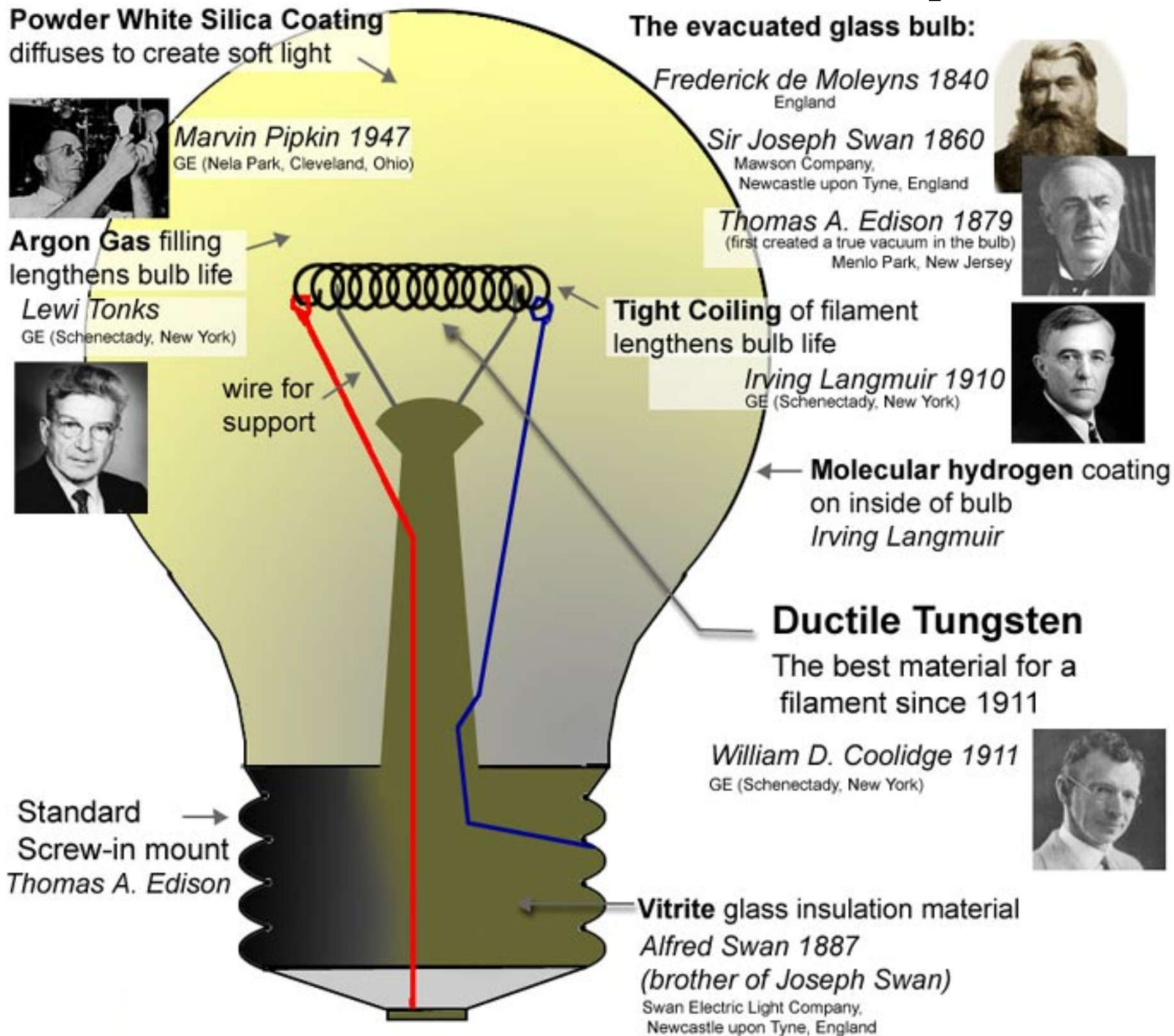



# Incandescent

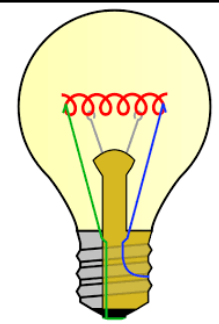

- Advantages

- Low initial cost
- Inexpensive to dim
- High colour rendering
- Can enhance texture

- Disadvantages

- Lowest efficacy
- Voltage sensitive
- Short life
- Heat generation

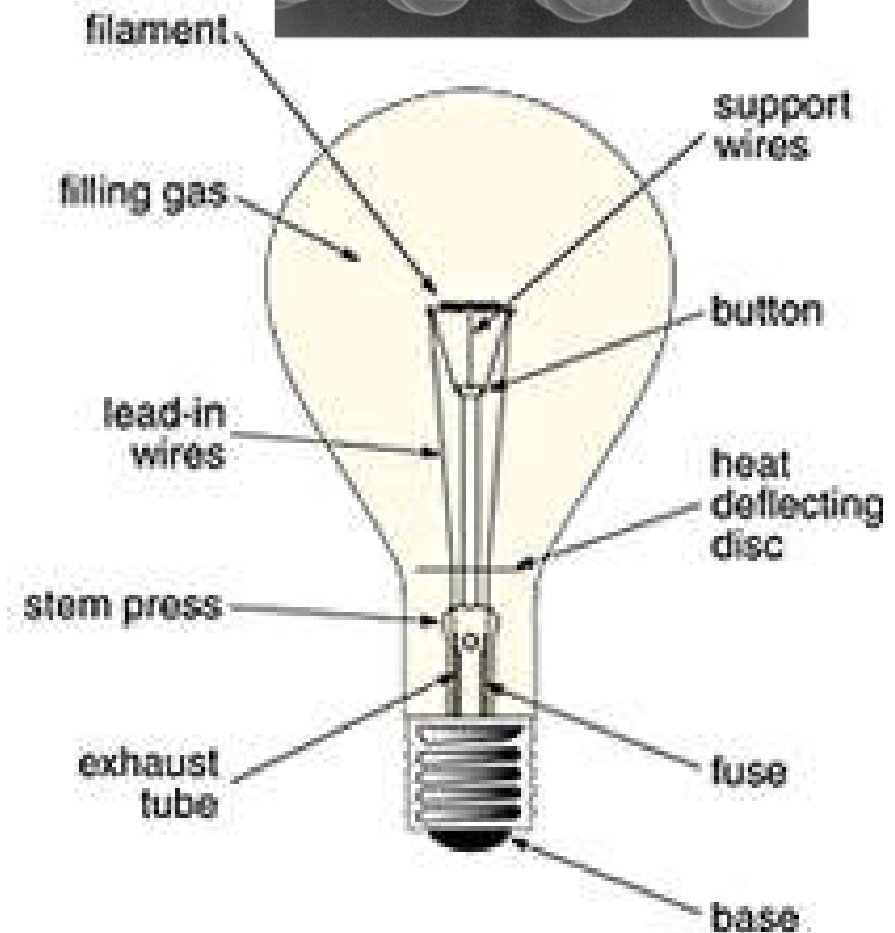
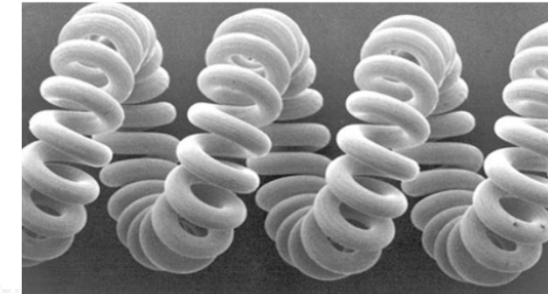

# Tungsten halogen cycle for incandescent lamp



Tungsten evaporates  
from filament

 Tungsten     Halogen



Evaporated tungsten  
reacts with halogen to  
form tungsten halide

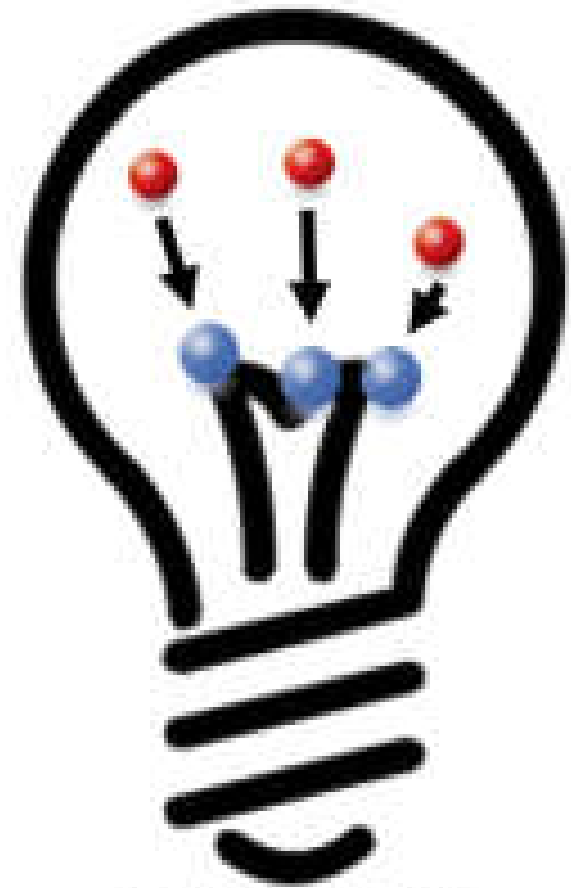

Tungsten halide  
dissociates, tungsten  
redeposits onto filament

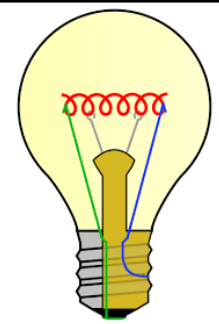

# Incandescent

- Specification
  - Lamp/Bulb shape designations
  - Typical filament construction
  - Common lamp bases

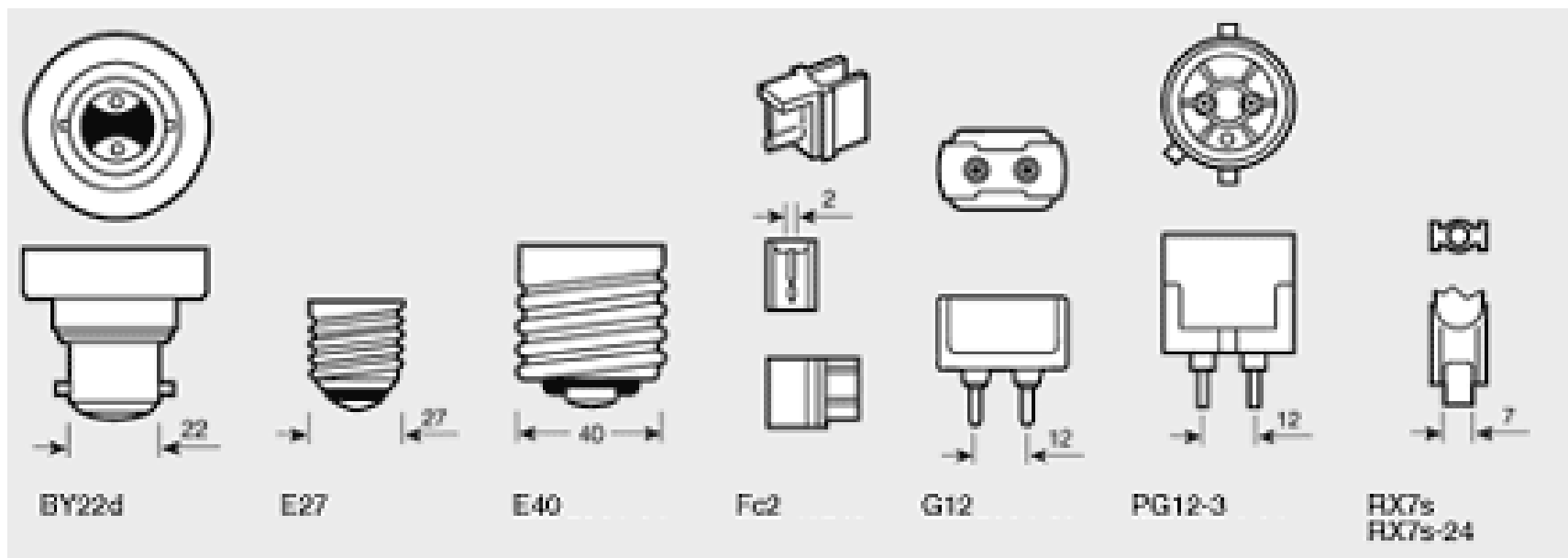

# Lamp shapes and bases

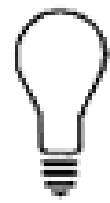

Type A



Type B



Type BA



Type BR



Type C

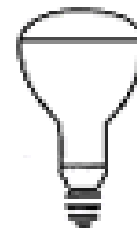

Type ER



Type F



Type G

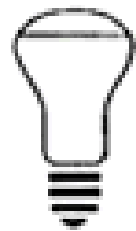

Type K

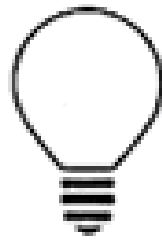

Type P



Type PAR

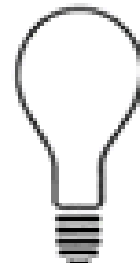

Type PS



Type R

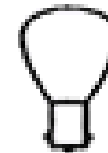

Type RP

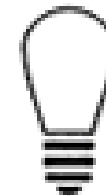

Type S

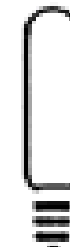

Type T

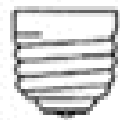

Medium  
(Standard)

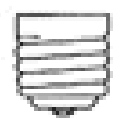

3 Cont.  
Med.



Med.  
Skirted



Mogul



3 Cont.  
Mogul



Mogul  
Prefocus

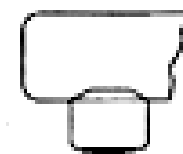

S-14s



Mini  
Cand.



Cand.



Cand.  
Bayonet  
SC/DC



Cand.  
Prefocus  
SC/DC



Inter-  
mediate

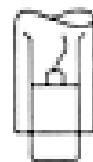

Recessed  
Single  
Cont.

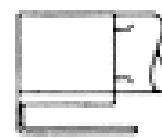

Metal  
Sleeve  
Flex Lead



Medium  
Side  
Prong

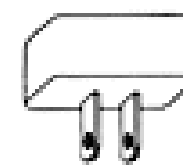

End  
Prong



Multi-  
purpose

# Incandescent

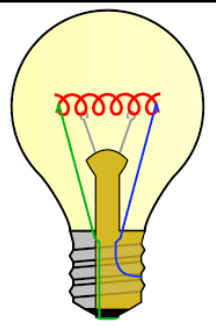

- Construction
  - Glass envelope
    - Lime glass, borosilicate (hard glass)
  - Fills
    - Vacuum, nitrogen, argon, krypton
  - Coatings
    - Acid etch, silica smoke, ceramic, paint
  - Basing
    - Aluminum, brass, nickel plated brass



# Incandescent

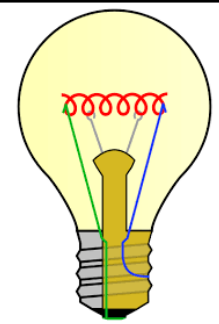

- Lamp characteristics
  - Colour temperature
  - Depreciation
  - Mortality (lifetime)
  - Life / lumens / colour / voltage relationships
  - Bulb & socket temperature

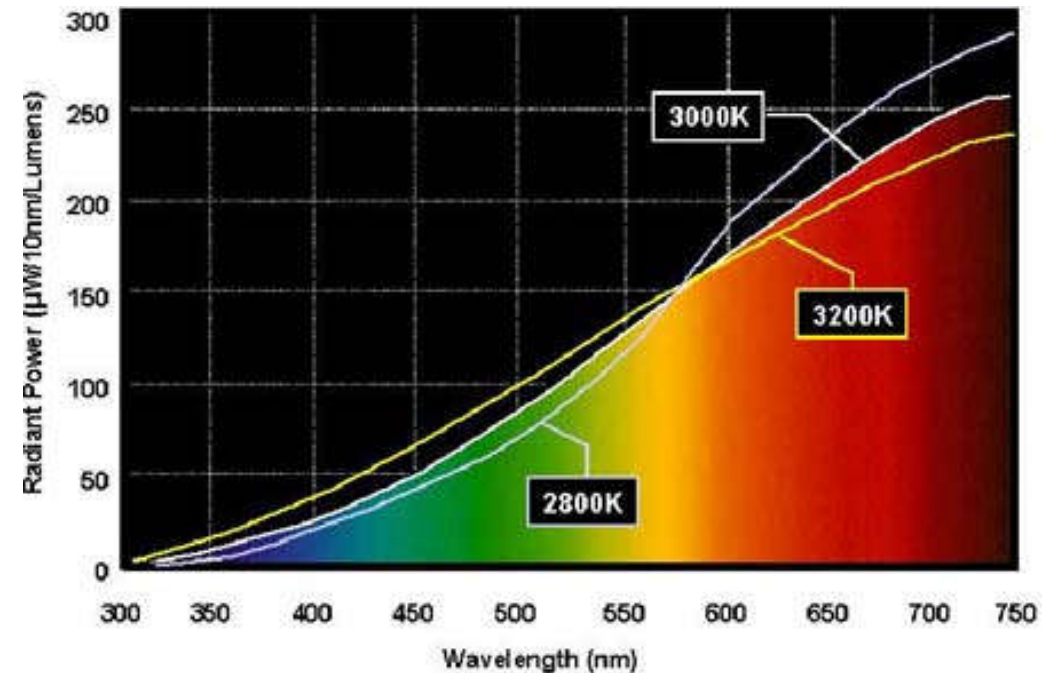

Spectral power distribution  
(incandescent)

# Incandescent

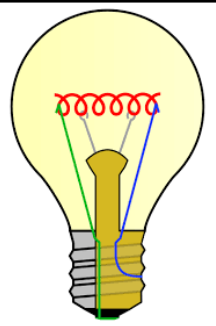

- Major types of incandescent lamps
  - Standard general service (GLS)
  - Decorative
  - Rough service
  - Vibration service
  - Sign lamps
  - Indicator
  - Three way



# Incandescent

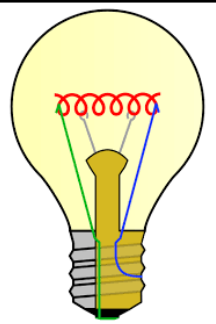

- Tungsten-halogen lamp, or quartz-halogen lamp (line voltage or low voltage)

- Advantages

- Compact size
- Whiter light
- Excellent lumen maintenance
- Longer life

- Disadvantages

- More costly





# Fluorescent



- Advantages

- High efficiency
- Super efficacy at high frequency operation
- Wide range of colour choices

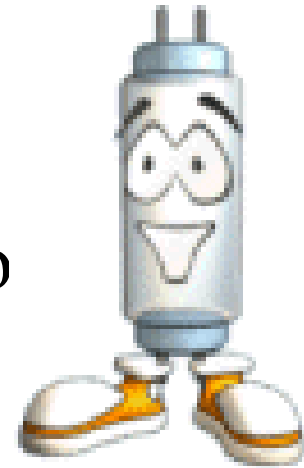

- Disadvantages

- Require ballast
- Temperature sensitivity



# Construction and operation of fluorescent lamp

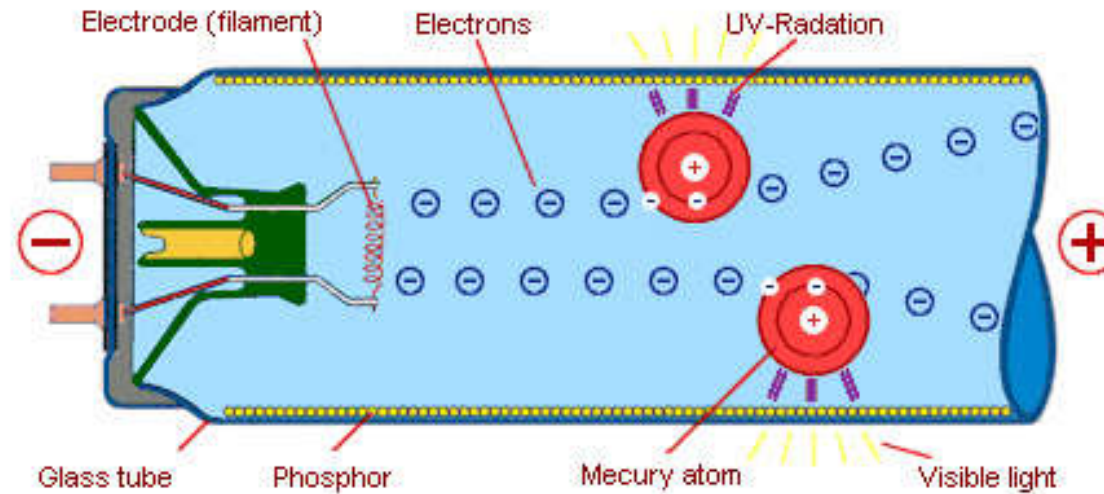

## Phosphor

Coating inside the bulb transforms ultraviolet radiation into visible light. Light color properties depend on composition of phosphor.

## Electrode

Electrodes at each end of lamp emits electrons. Usually made of single-coil tungsten wire.

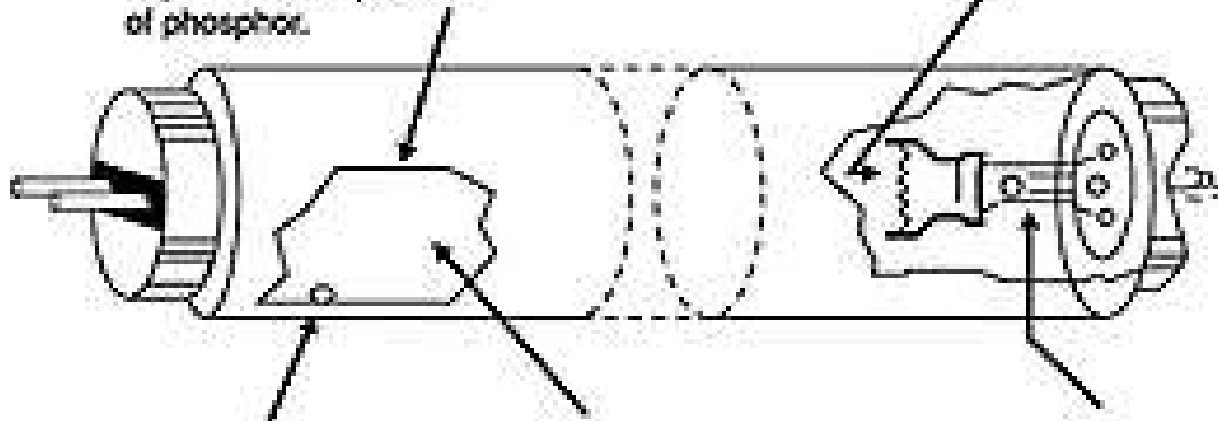

## Mercury

A minute quantity of liquid mercury is placed in the bulb to furnish mercury vapor.

## Gas

Usually argon or a mixture of inert gases at low pressure. Krypton is sometimes used.

## Lead-in Wires

Connect to the base pins and carry the current to and from the electrodes and the mercury arc.



# Fluorescent



- Types of fluorescent lamps 螢光燈
  - Linear (tubular)
  - Compact
  - Circline
  - U shape
  - Subminiature
  - Reflector
  - Cold cathode

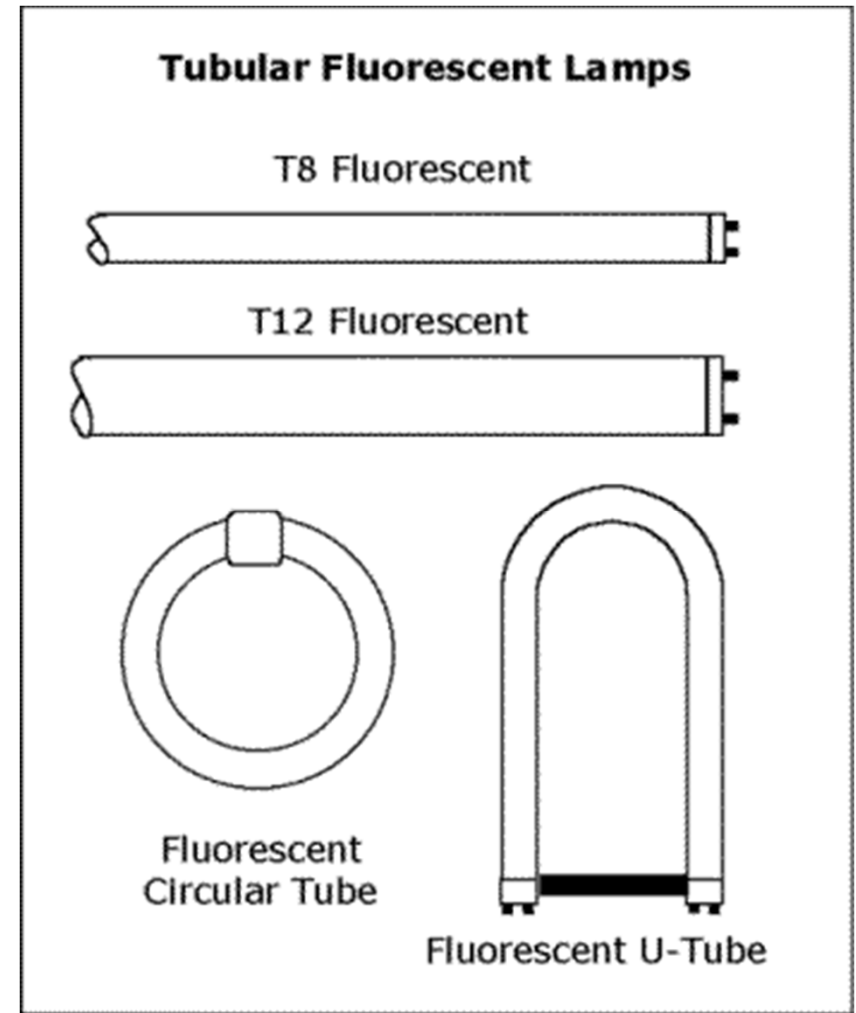

# Fluorescent



- Fluorescent lamp identification

- Example: F30T12/CW/RS

- "F" ... fluorescent
- "30" ... rated nominal wattage
- "T" ... tubular shape
- "12" ... diameter in eighths of an inch;  $12/8 = 1.5$  in.
- "CW" ... color; this lamp is a cool white lamp
- "RS" ... mode of starting; rapid-start lamp

- Linear (tubular) fluorescent lamps typical lengths:

- 600 mm (2 ft), 900 mm (3 ft), 1200 mm (4 ft), 1500 mm (5 ft), 2400 mm (8 ft)

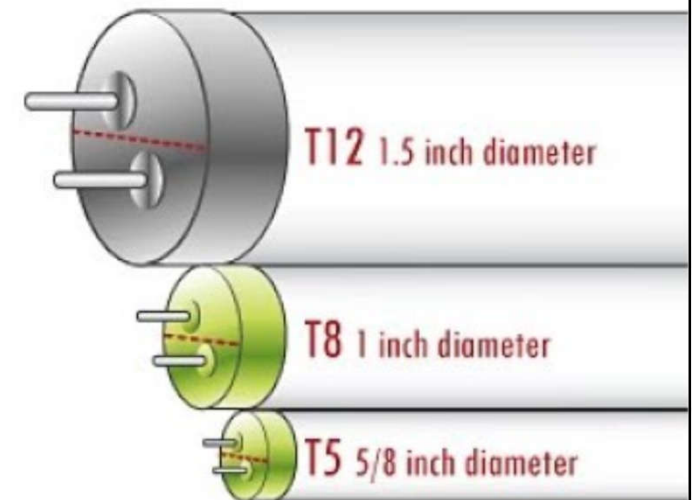

# Fluorescent



- Classification of fluorescent lamps
  - Lamp shapes
  - Lamp bases
  - Coating technology for (double- & tri-) Phosphor
- Lamp characteristics
  - Efficacy (longer the lamp, higher the efficacy)
  - Temperature effects
  - Strobe effect (flicker)
  - High frequency operation

# Fluorescent



- Operating characteristics
  - Light output vs. ambient temperature
    - Optimal at 25 °C (highest lumens per lamp)
    - Also affect the colour of the light produced
  - Lumen maintenance
    - Initial lumens decrease w/ operating hours
  - Effect of starting frequency on lamp life
    - Loss of the electron emissive coating on electrodes
    - Rated average life = based on 3 hrs operation per start

# Fluorescent



- Compact fluorescent

- Advantages

- Compact size
    - High efficacy
    - High CRI
    - Long life
    - Dimmable (some)
    - High frequency operation
    - Excellent lumen maintenance

- Disadvantages

- Position sensitive
    - Thermal sensitivity
    - Require ballast
    - Higher initial cost (over incandescent)



Quad-lamp



Triple-twin

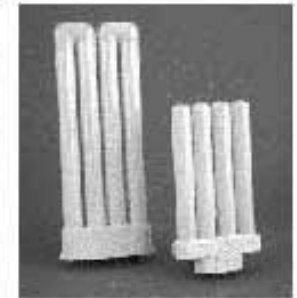

F-lamp



Twin-tube



Circline

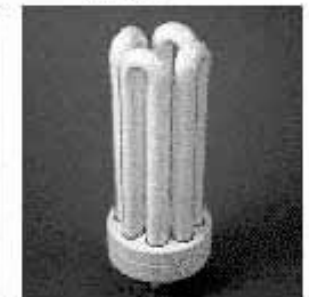

Oct lamp

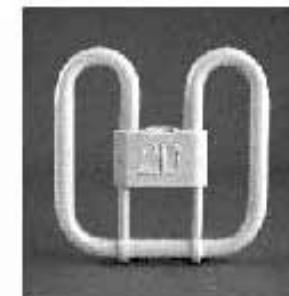

2-D



Helical

# Fluorescent



- Compact fluorescent 一體式螢光燈 / 慳電膽
  - Types
    - Twin tubes
    - Quads
    - Triples
    - Globes
    - Reflectors
  - Adapter ballasts
  - Self-ballasted

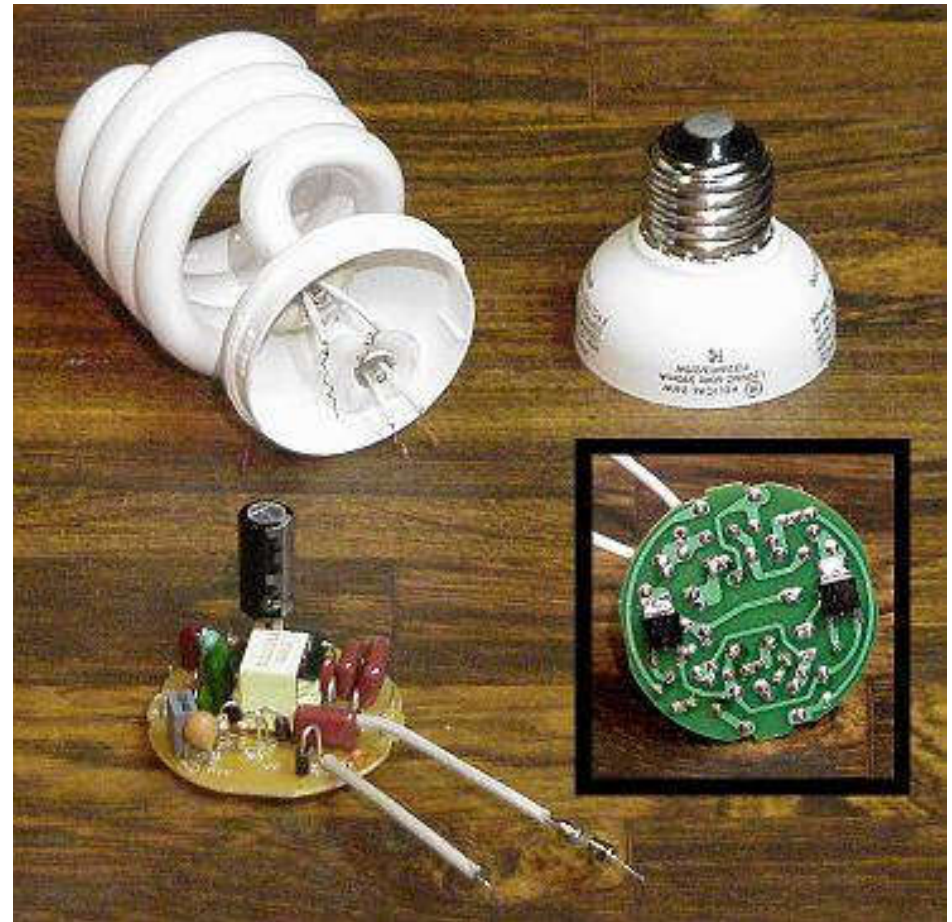



# Fluorescent



- Compact fluorescent
  - Thermal factor affecting light output & performance
  - Bulb wall temperature
    - Lamp positioning
    - Luminaire design (e.g. ventilation)
    - Plenum temperature
    - Ambient temperature
    - Amalgam temperature
  - Ballasting



Integral

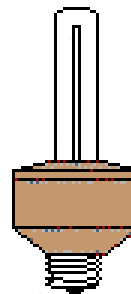

Modular

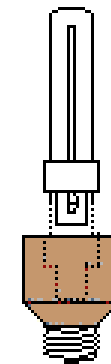

Dedicated

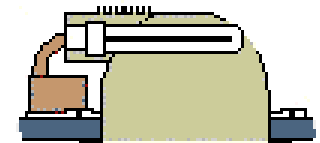

# High intensity discharge (HID)



- High intensity discharge (HID) lamps
  - Electrical gas-discharge lamp which produces light by means of an electric arc between tungsten

- Types of HID lamps:

- Mercury vapour
- Metal halide
- High pressure sodium
- \* See examples in LampTech website
  - <http://www.lamptech.co.uk/>

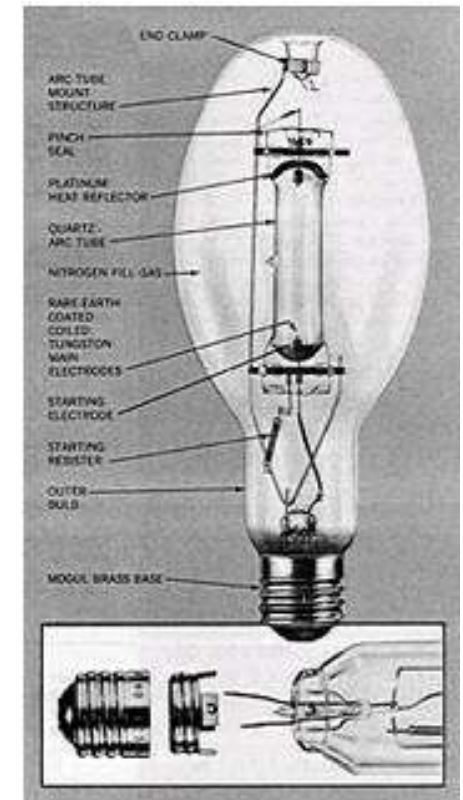

# High intensity discharge (HID)



- Video: What is HID? (4:06)  
<https://youtu.be/3oHwO-Xu8w4>



- Mercury vapour\*
  - Advantages
    - Good for landscape lighting
  - Disadvantages
    - Lowest HID efficacy
    - Poor lumen maintenance
    - Poor colour
  - (\* historical, use less nowadays)



# Construction of mercury vapour lamp

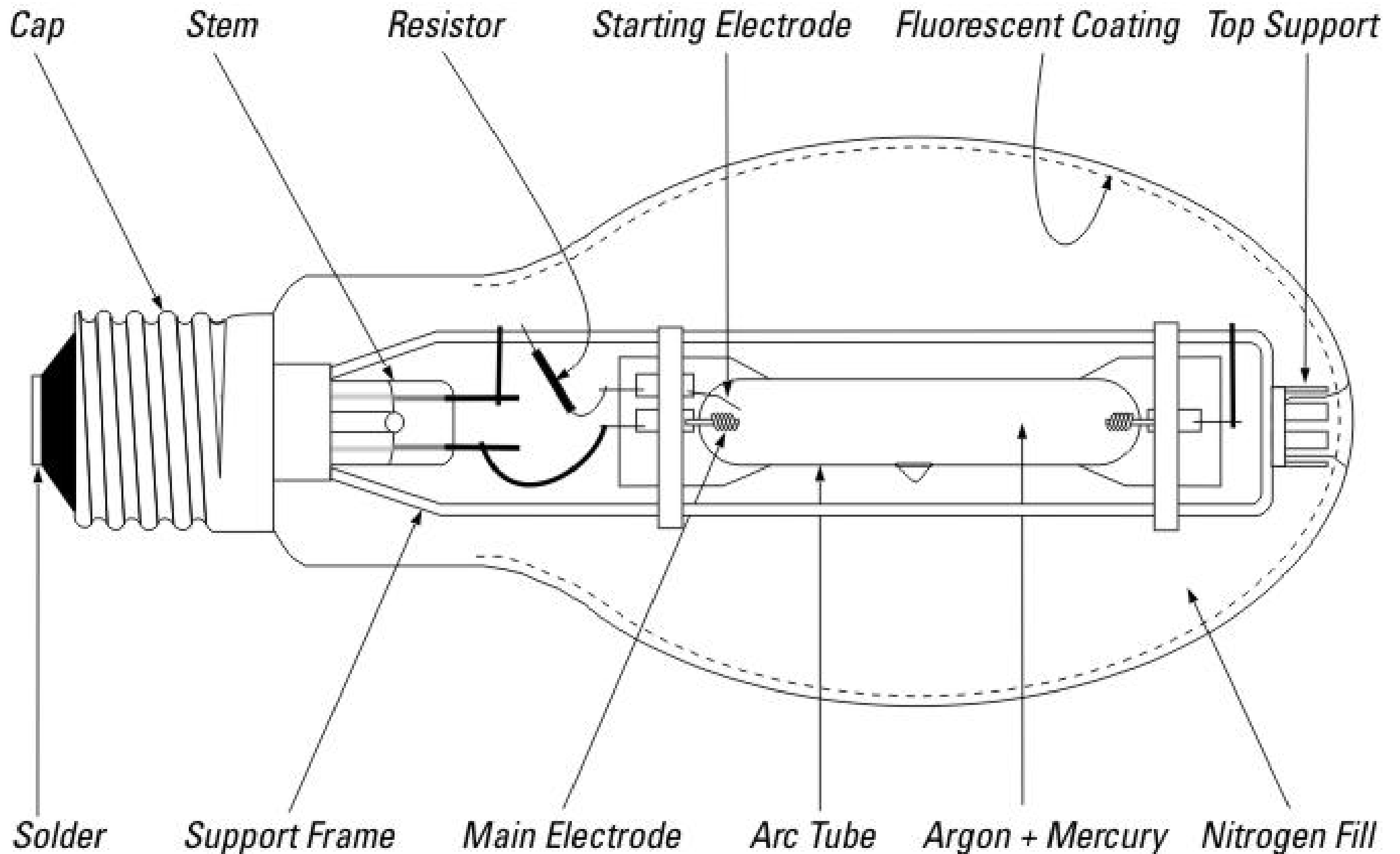

# High intensity discharge (HID)



- Mercury vapour

- Lamp types

- Standard, PAR (parabolic), R (reflector), Safety

- Operating characteristics

- Starting characteristics
    - Lamp operating position (vertical/horizontal)
    - Lamp life & lumen maintenance
    - Temperature effects
    - Flicker & strobe

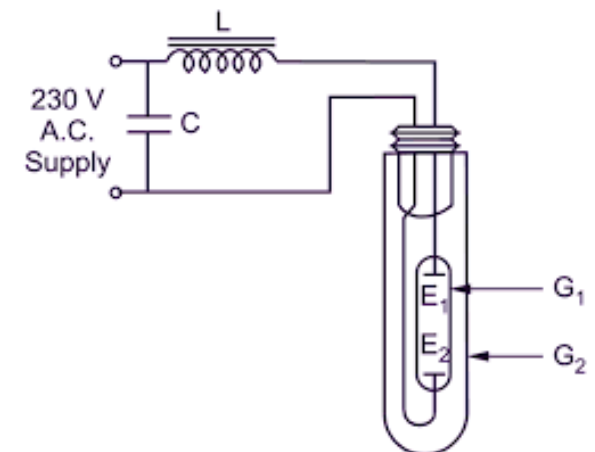

# High intensity discharge (HID)



- Metal halide
  - Advantages
    - High efficacy
    - Good to excellent colour
    - Good lumen maintenance
    - Wide range of wattages



- Disadvantages
  - Colour shift
  - Hot restrike time



# High intensity discharge (HID)



- Metal halide
  - Lamp types
    - Standard
    - High output
    - PAR (parabolic)
    - Open luminaires
    - Safety
    - Double ended

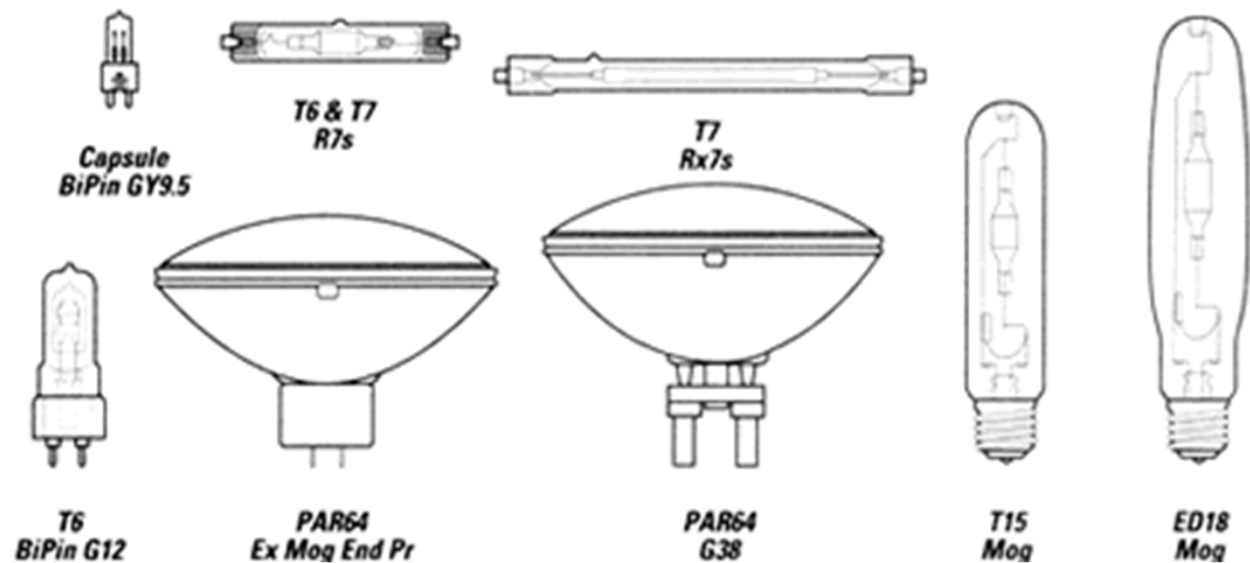

# High intensity discharge (HID)



- Metal halide
  - Operating characteristics
    - Starting characteristics
    - Lamp operating position (vertical/horizontal)
    - Lamp life & lumen maintenance
    - Temperature effects
    - Flicker & strobe

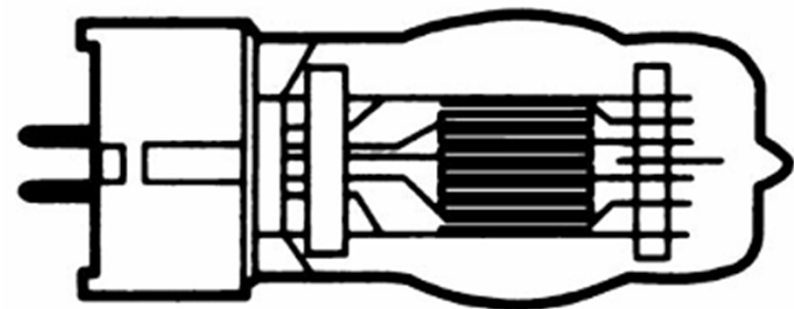
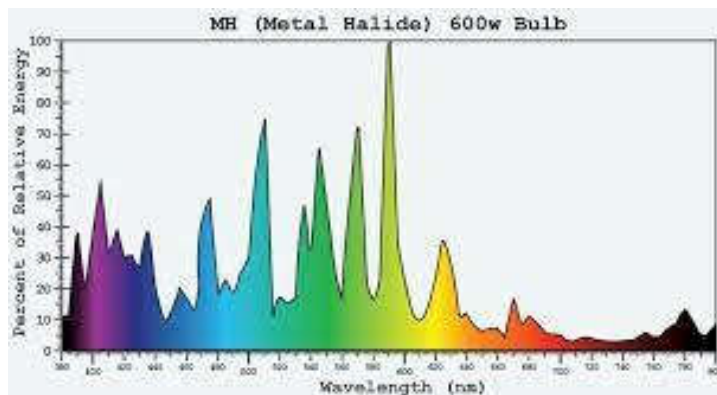

For theatre projection



# High intensity discharge (HID)



- High pressure sodium
  - Advantages
    - High efficacy
    - Long life
    - Universal burning position
    - Wide range of wattages
    - Good lumen maintenance
  - Disadvantages
    - Colour (standard lamp)
    - Require ballast
    - Cycling (standard lamp)

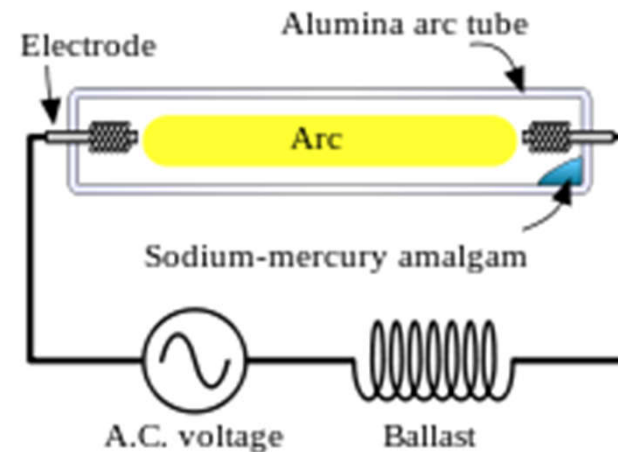

ED18  
Mog (SBY/LL)

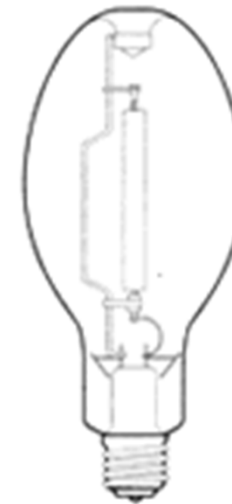

ED37  
Mog



E25  
Mog

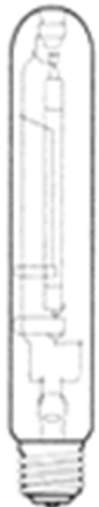

T15  
Mog

# High intensity discharge (HID)



- High pressure sodium
  - Lamp types
    - Standard
    - Standby/instant restrike
    - High output
    - Non-cycling
    - Deluxe colour
    - Double ended
    - Self-ballasted
    - Mercury retrofit
  - Operating characteristics
    - Starting characteristics
    - Lamp operating position (vertical/horizontal)
    - Lamp life & lumen maintenance
    - Temperature effects
    - Cycling



HID Hut 600W HPS Bulb Spectrum Chart

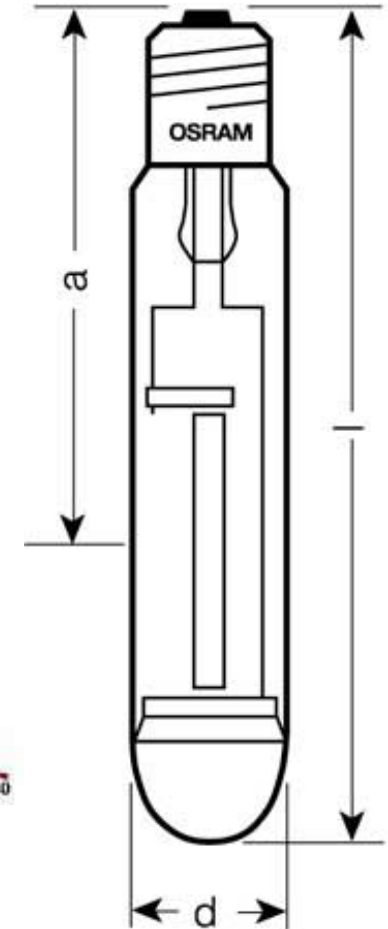
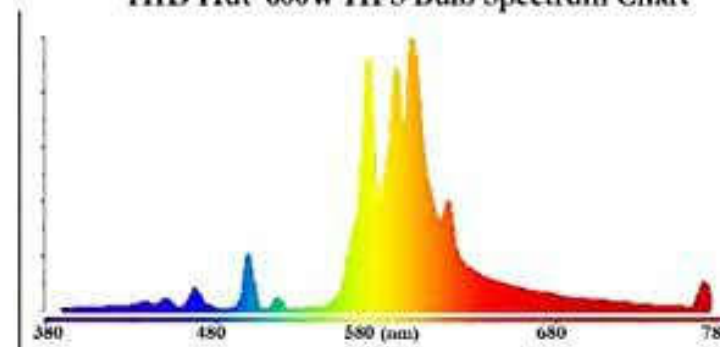

# Low pressure sodium

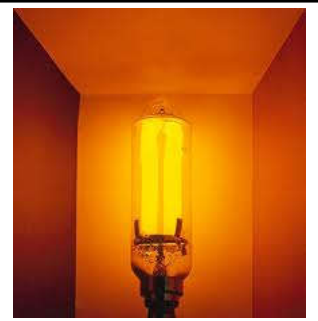

- Low pressure sodium

- Advantages

- Highest efficacy
    - Hot restrike

- Disadvantages

- Monochromatic
    - Optical control
    - Lamp disposal
    - Increased wattage over life

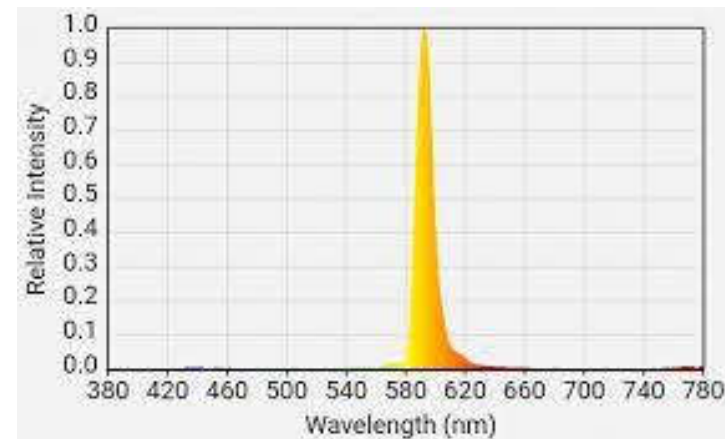
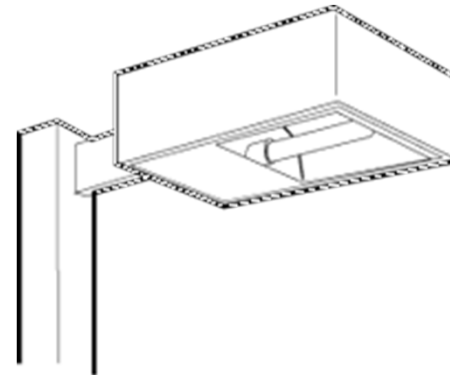
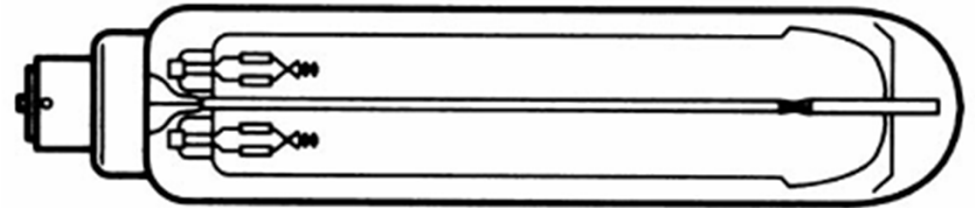

# Low pressure sodium lamp

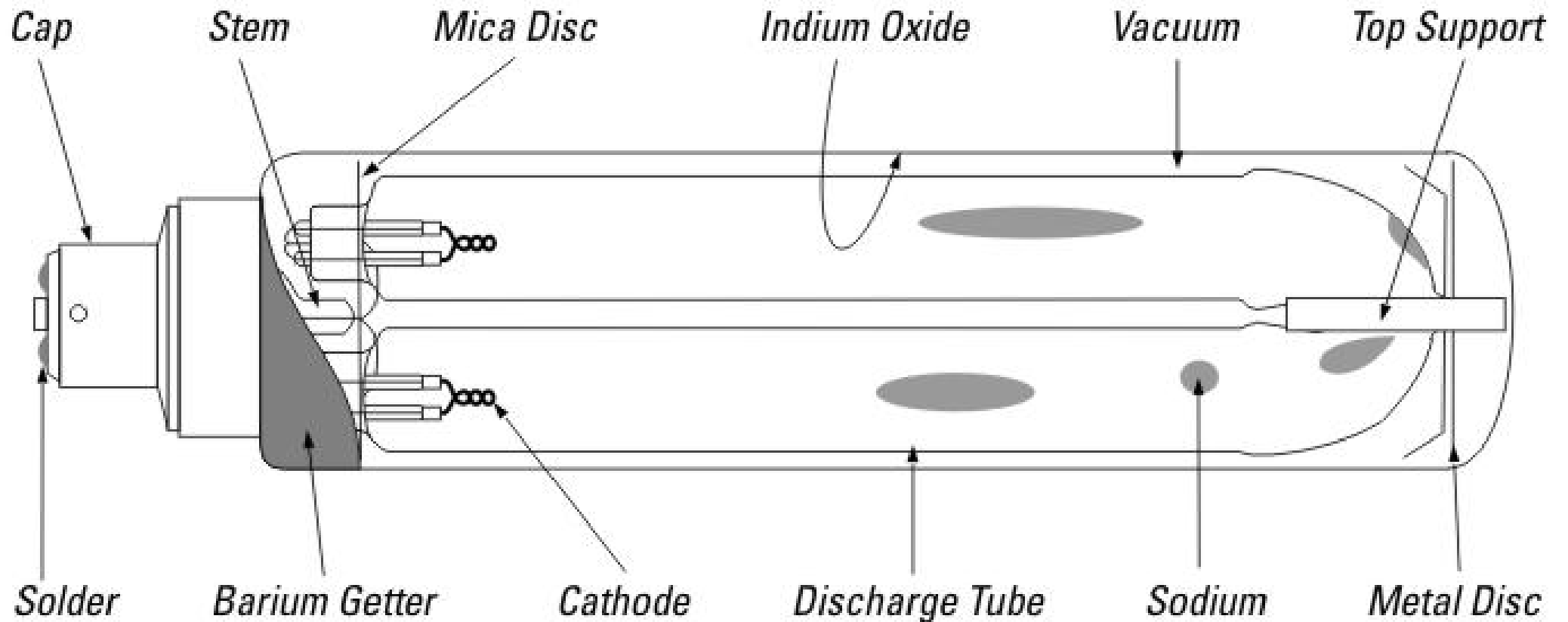



# Induction lamps

- They are gas discharge lamps that do not have electrodes
- The electric field in the lamp is induced by an induction coil that is operating at high frequency



# Induction lamps based on fluorescent lamp technology

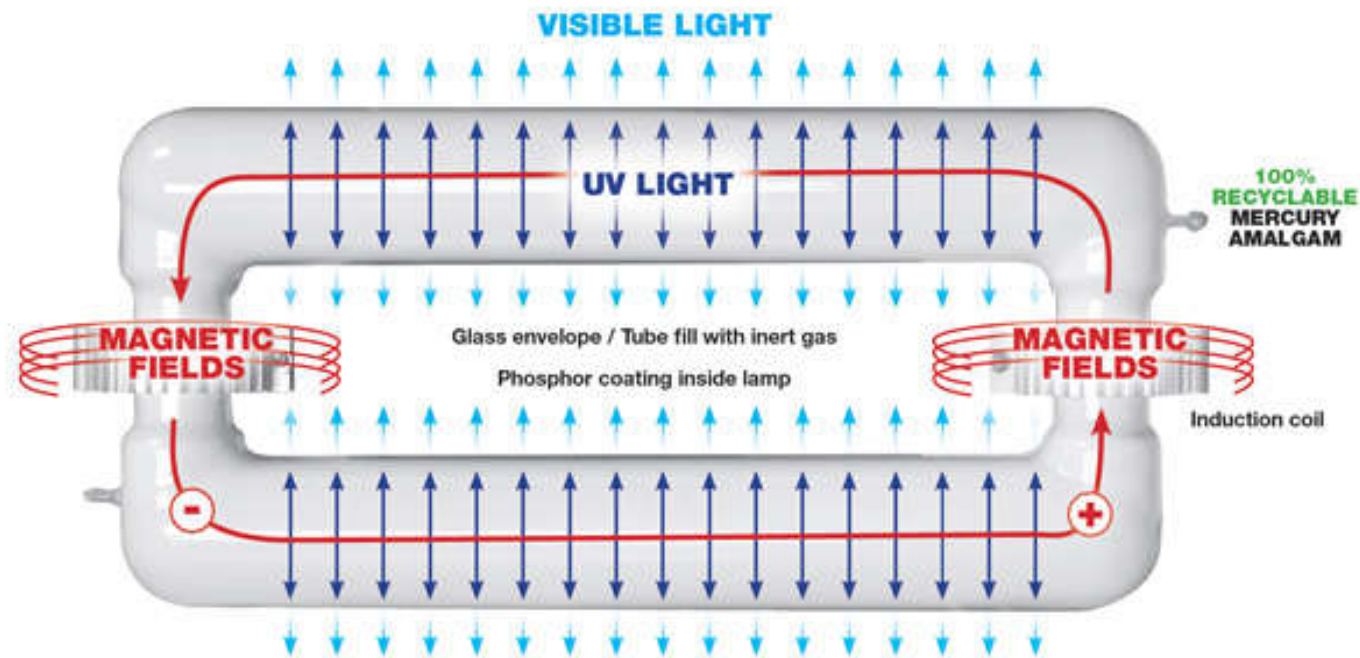
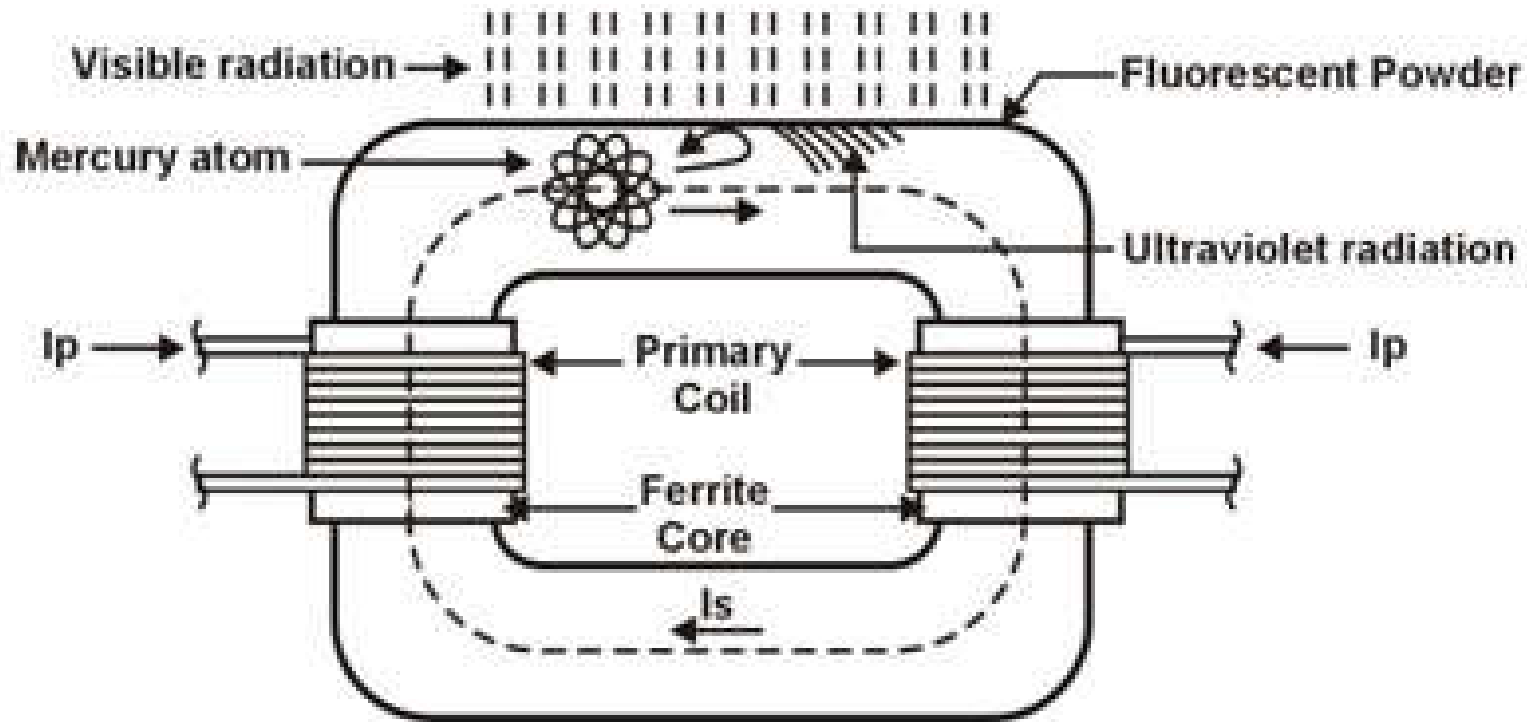



# Light emitting diode (LED)

- Light emitting diode (LED)
  - Produces light by electroluminescence at low voltage “p-n” junction (e.g. indicator lights)
  - Development of white light & high output LEDs enables wider use in lighting systems

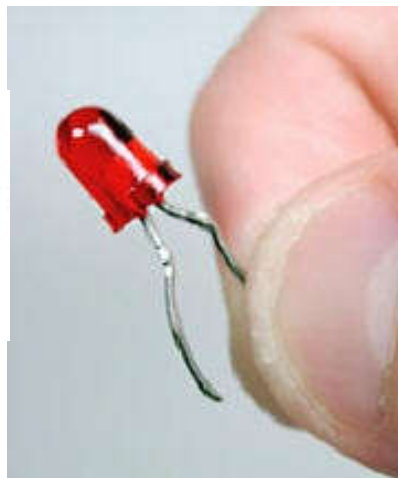

# Light cones emitted by clear and diffuse LED lenses

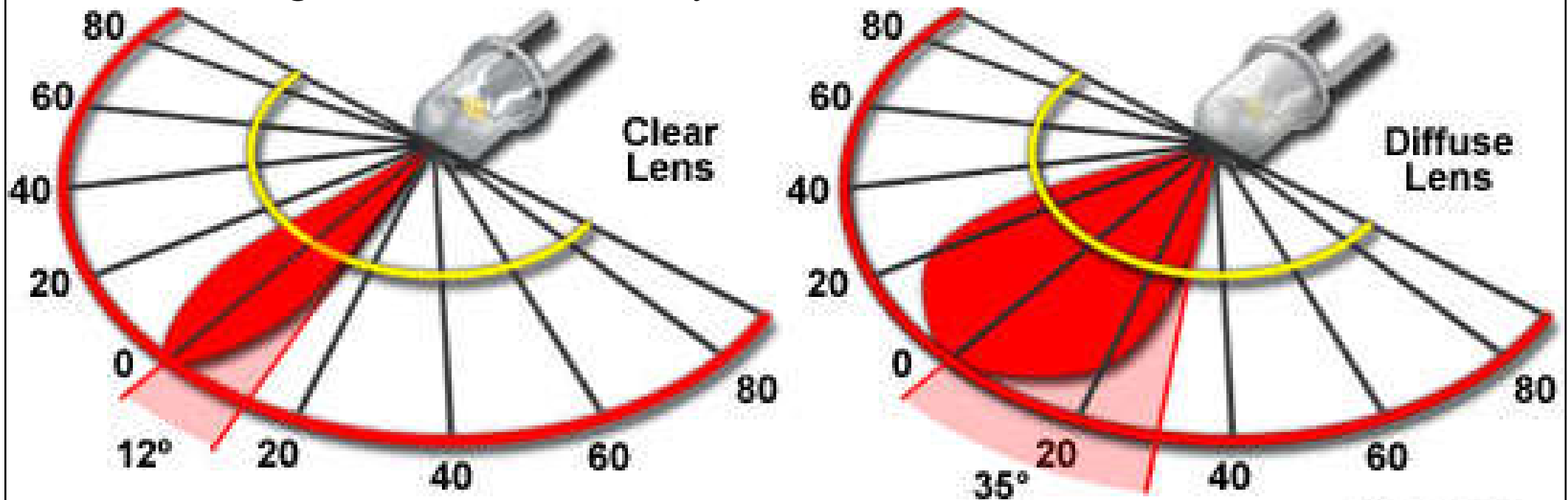

— 50% Intensity — 100% Intensity

## LED Light Escape Cone

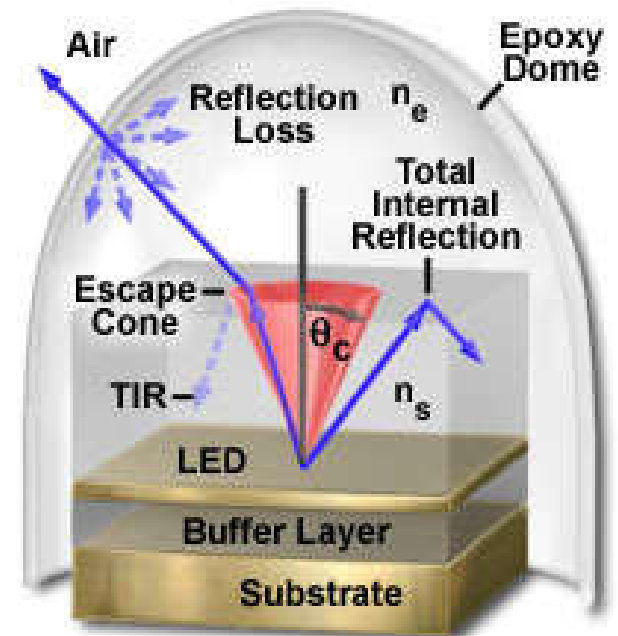
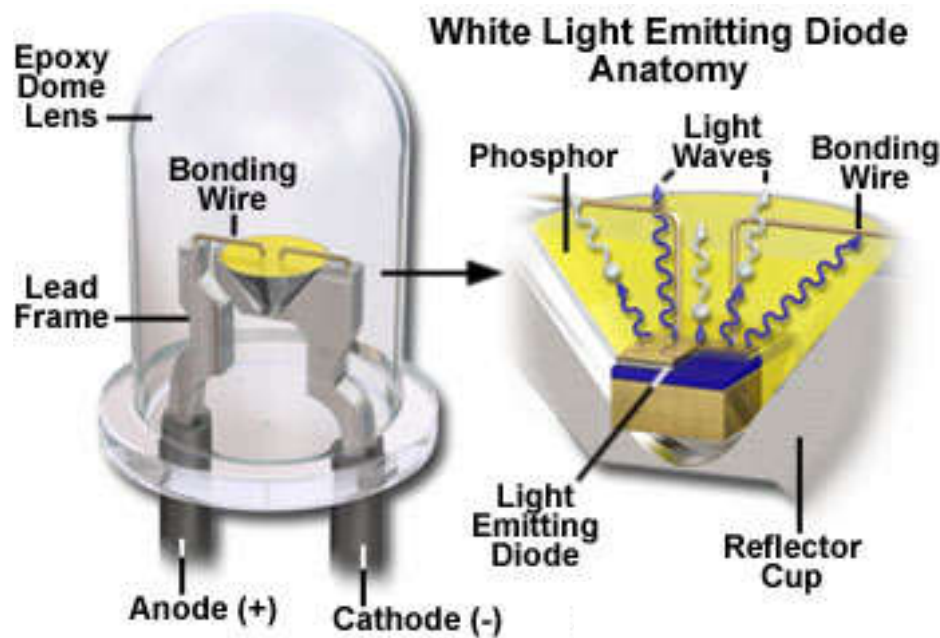



# Principle of LED and structure of high power white LED\*

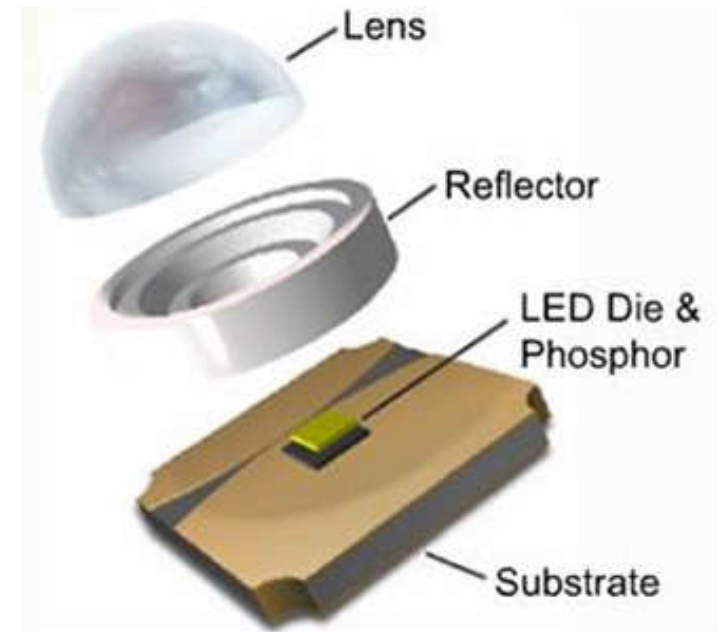
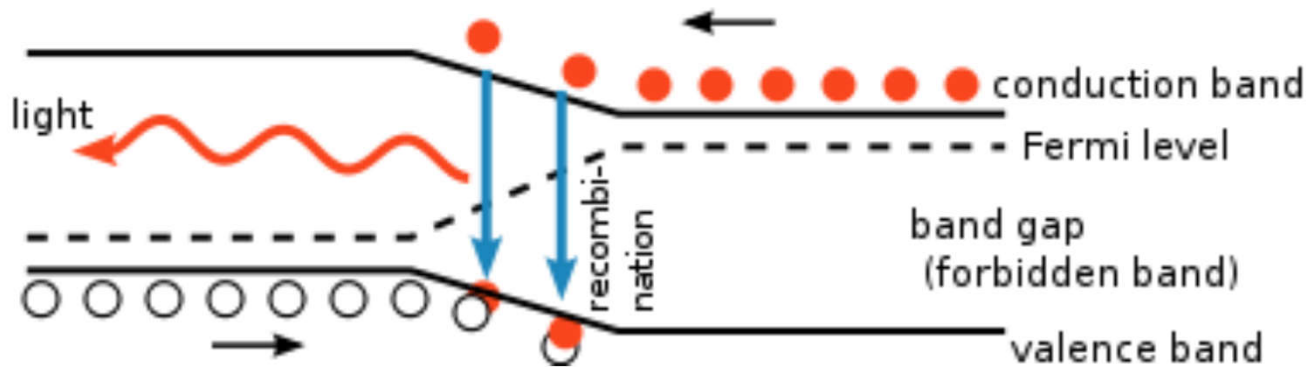
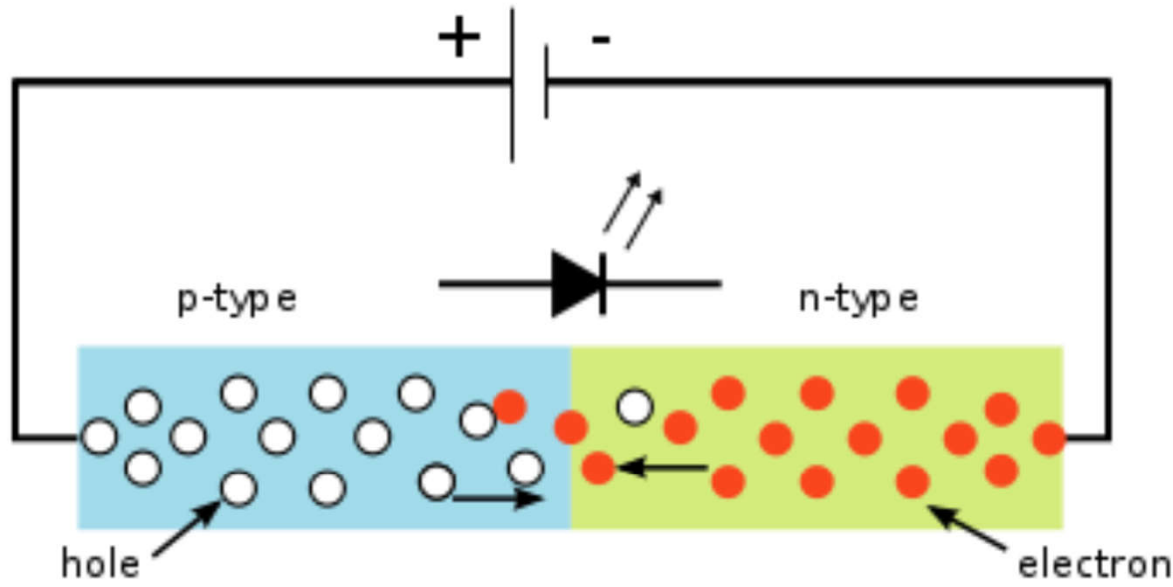

Structure of high power white LED

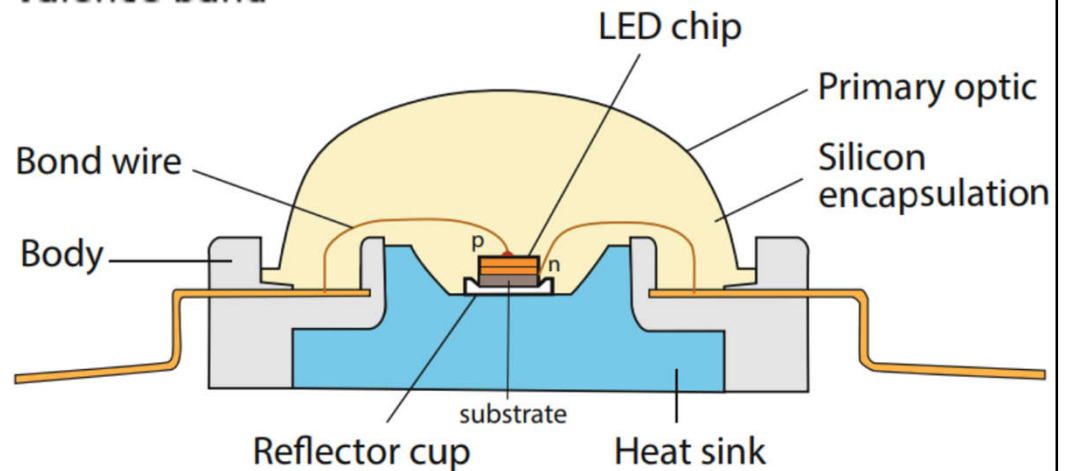

(\* See How LED Works, <http://www.omslighting.com/ledacademy/>)



# Light emitting diode (LED)

- Solid state lighting (SSL)
  - Emits light from semi-conductor (solid)
    - Light emitting diode (LED)
    - Organic light-emitting diodes (OLED)
    - Polymer light-emitting diodes (PLED)
  - Advantages:
    - Low power consumption
    - Reduced heat generation
    - Greater resistance to shock, vibration, and wear
  - LED retrofits (not ideal), versus LED luminaires



# New generation of LED lighting fittings



Linear lights (flexible & rigid)



Recessed luminaires

Recessed downlights



LED panels



LED tubes



LED bulbs



# Light emitting diode (LED)

- Light emitting diode (LED)

- Advantages

- Low power consumption
    - Long lasting (long useful life)
    - Durable (withstand impact & vibration)
    - Cool (little heat produced)
    - Modular design & compact size
    - Controllability (colour balance & intensity)
    - Instant on, frequent switching
    - No annoying flicker
    - Low cost of manufacture
    - No ultraviolet & infrared radiation
    - Mercury free

- Disadvantages

- Focused, directional light
    - Need different optics design
    - May need heat sink (thermal management)

LED candles





# Light emitting diode (LED)

- White light LED
  - Mixing light from multiple LEDs of various colours, or using a phosphor to convert some of the light to other colors

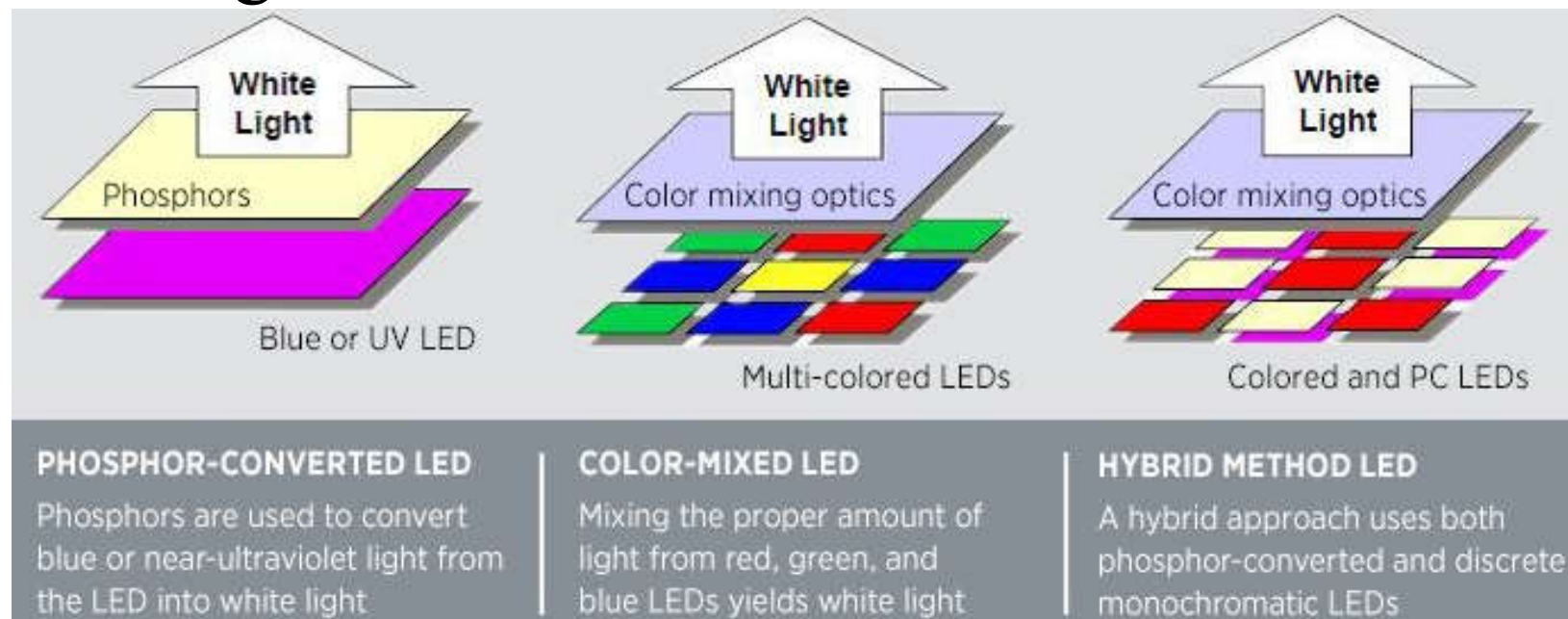



# Light emitting diode (LED)

- Colour changing LED lighting
  - Tunable lighting systems employ banks of coloured LEDs that can be individually controlled
- LED drivers
  - An appropriate circuit to control electrical power
- Thermal management & heat mitigation
  - The housing of high-power LEDs should be designed to adequately dissipate heat
  - Efficiency decreases with operating temperature





# Light emitting diode (LED)

- Video: LEDs and OLEDs - How it Works, Inventors (7:18)



- <https://youtu.be/8quZrUcRFlw>
- All about Light Emitting Diodes and Organic LEDs. How they work, the difference between them.
- Learn about the inventors of the lights at the end of the program.



# Light emitting diode (LED)

- Organic light emitting diode (OLED)
  - LED made of organic semiconductor material
  - Can create large area lighting panels
  - Can be used to make flexible & transparent panels
  - They are expensive & difficult to produce

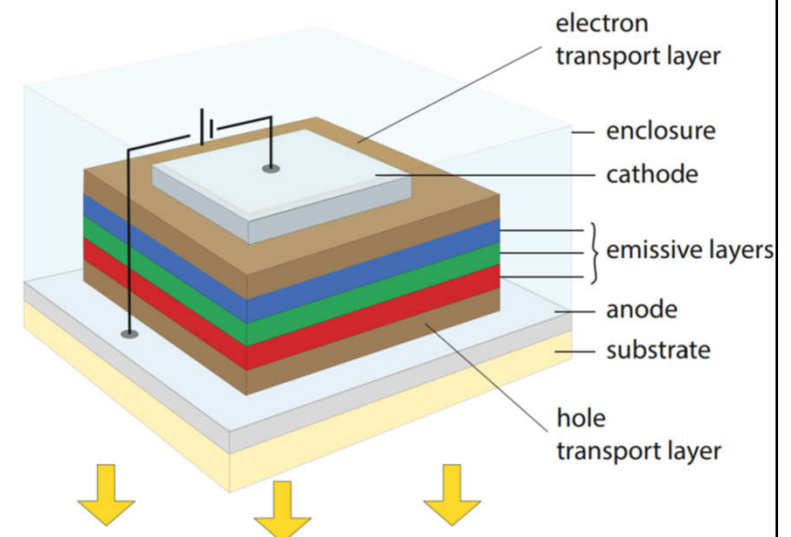



# OLED structure and materials

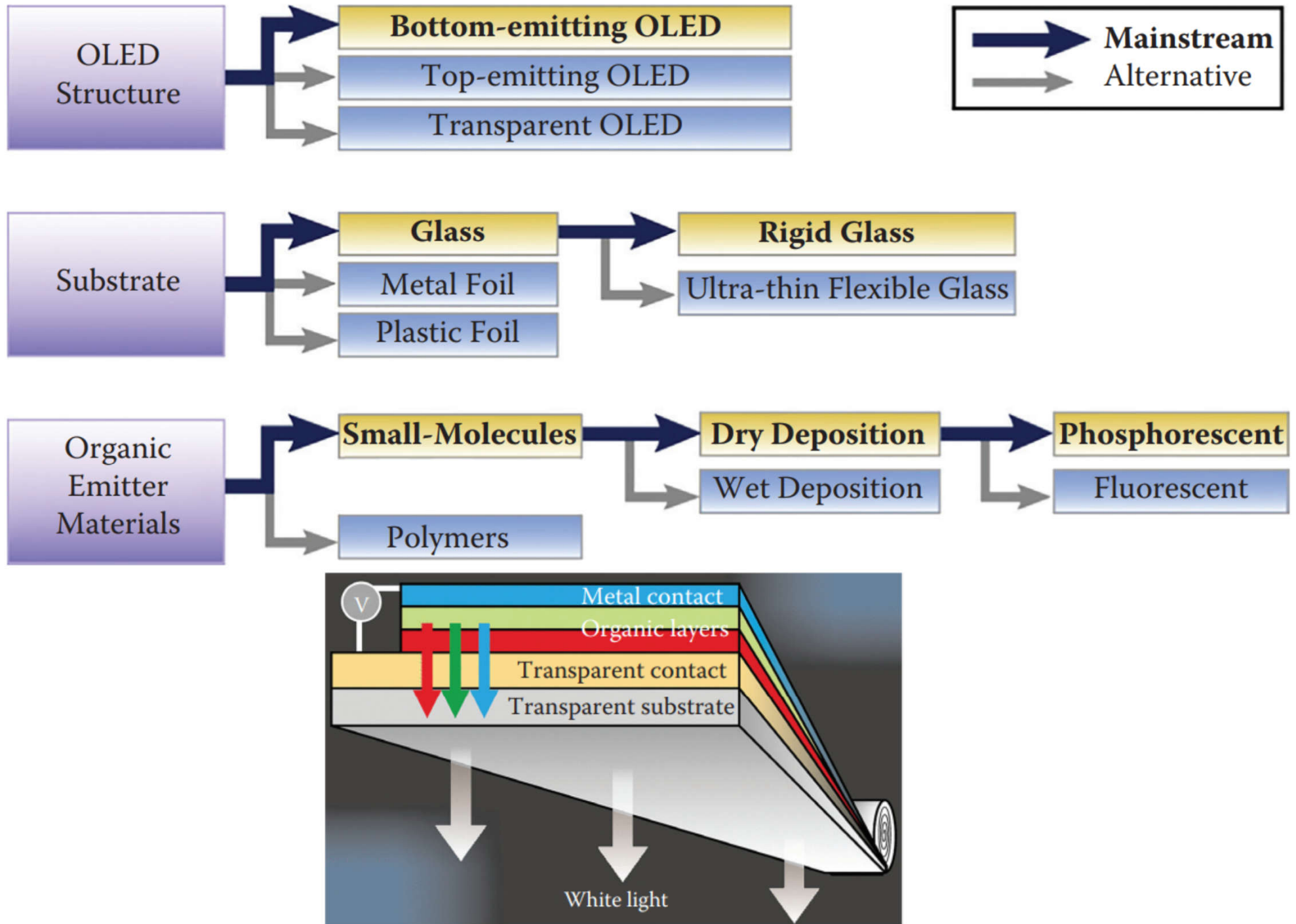

# Luminaires

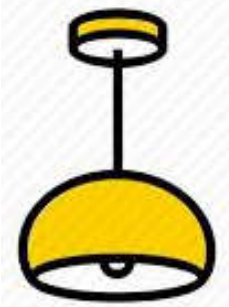

- Luminaire (light fixture)

- A complete lighting system:

- A housing and lampholders
- Lamps (w/ a ballast/transformer)
- Optical system

- Reflector, and either a lens, louver or diffuser
- For controlling brightness

- It may also include some type of electrical control dimmers, hilo switching, daylight sensors, etc.

- Control light distribution in various directions

## IDENTICAL REFLECTORS

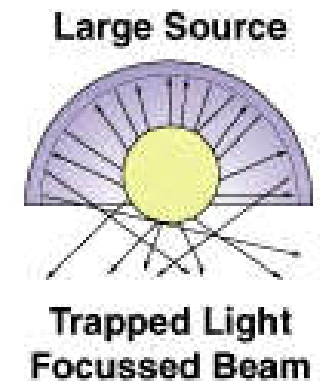
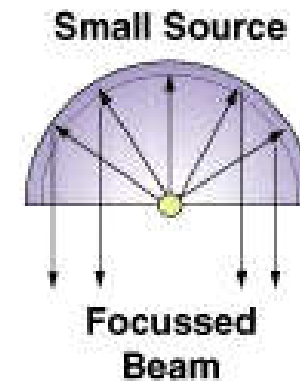

# Light distribution of a luminaire

(The lengths of the arrows represent the luminous intensities)

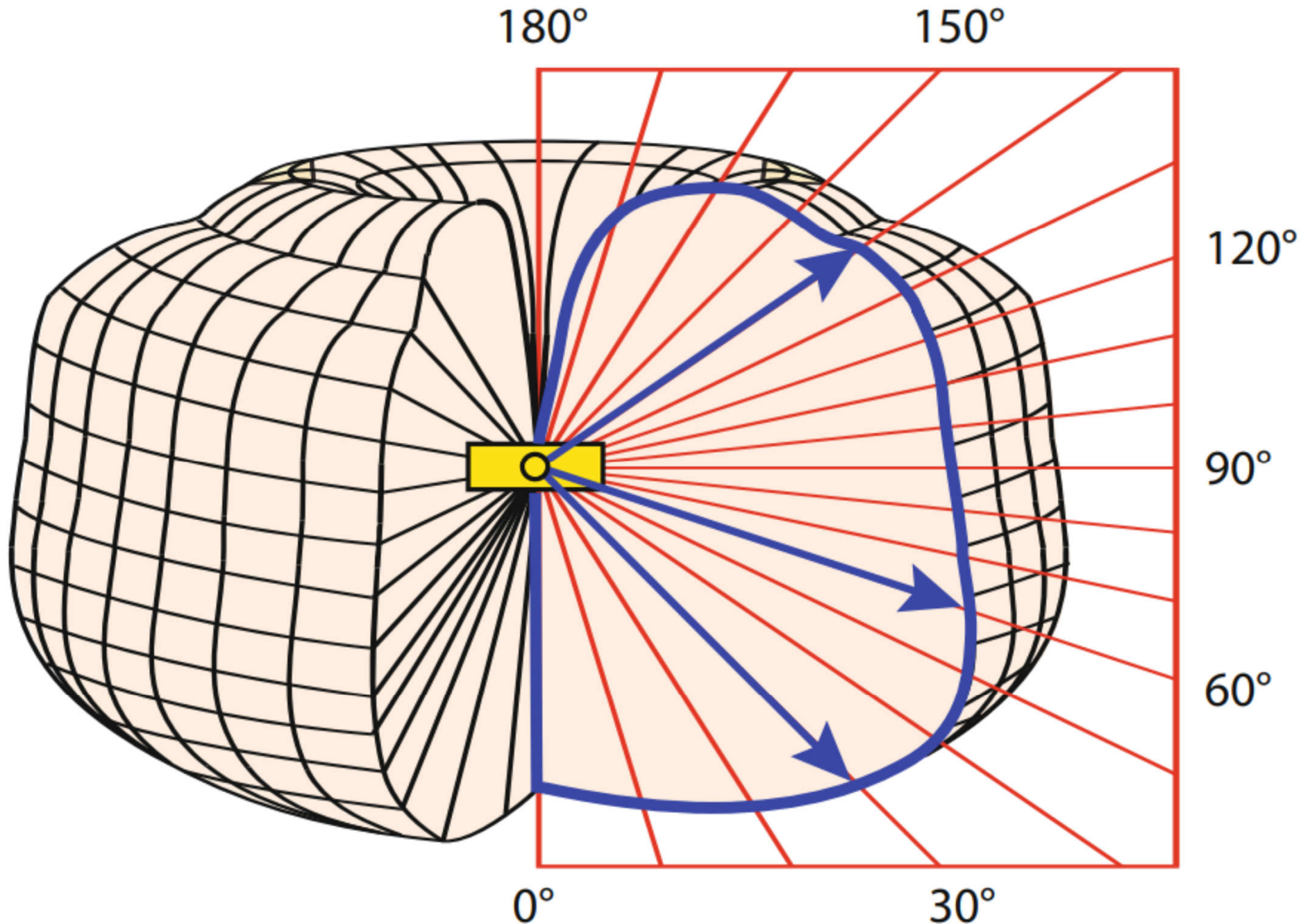

# Luminaires

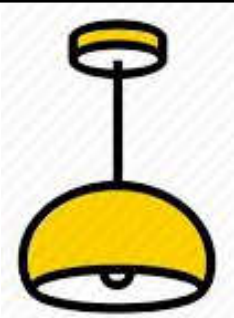

- Six basic classifications of luminaires:
  - Direct luminaire where all the light is directed down
  - Semi-direct luminaire where the majority of the light is directed down
  - General diffuse luminaire where light is distributed in all directions
  - Direct-indirect luminaire where light is distributed equally up and down
  - Semi-indirect luminaire where the majority of light is directed up
  - Indirect luminaire where all the light is directed up

# Luminaire classification system for indoor lighting luminaires

## Direct

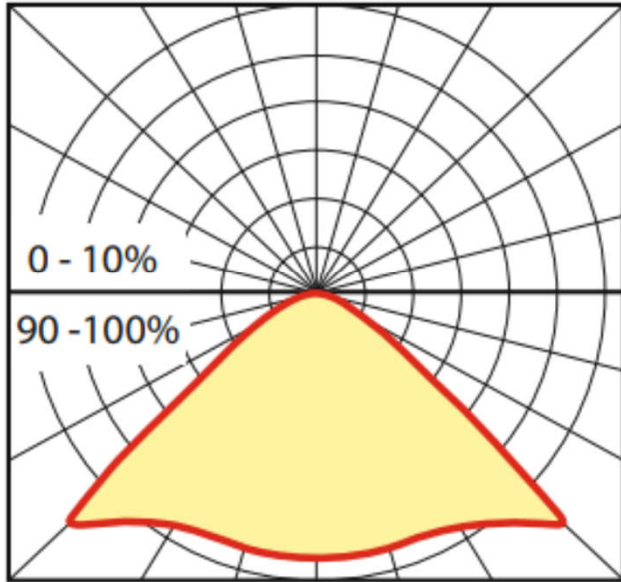

## Semi-direct

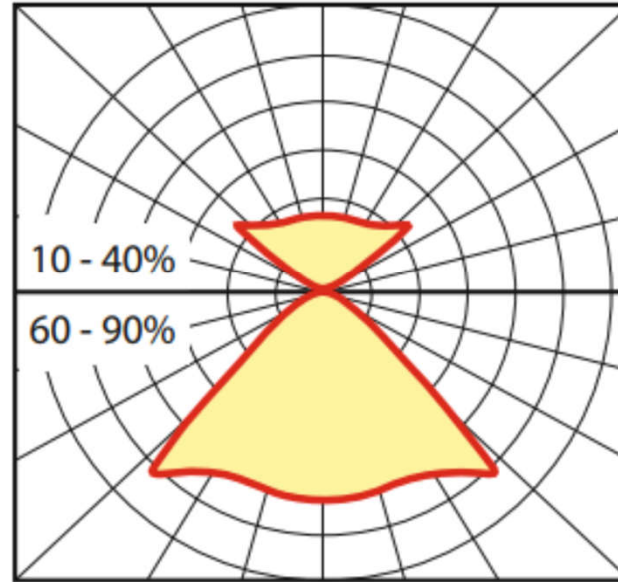

## Direct-indirect

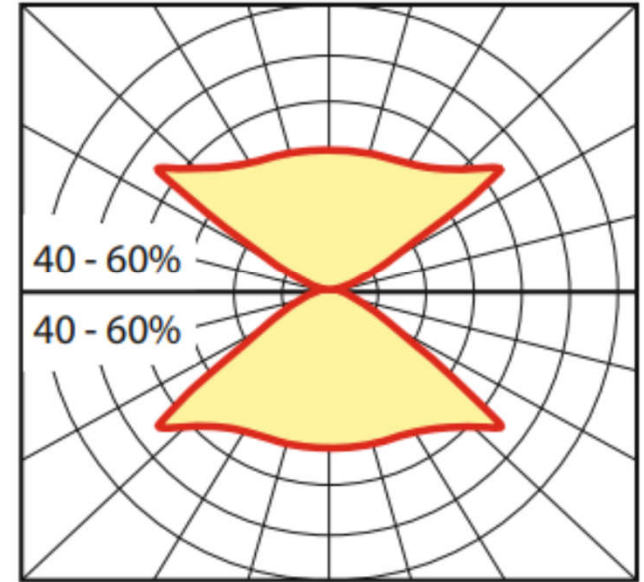

## Indirect

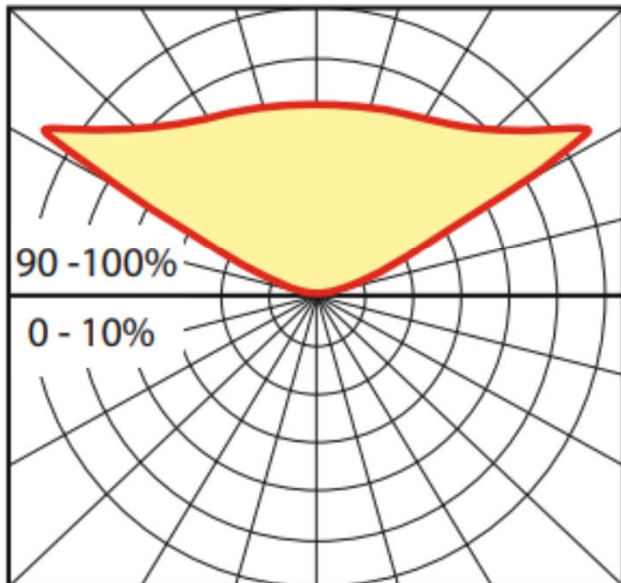

## Semi-indirect

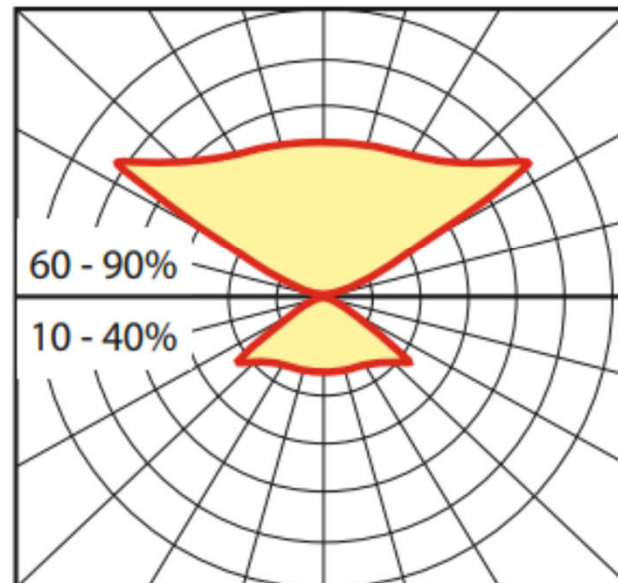

## General-diffuse

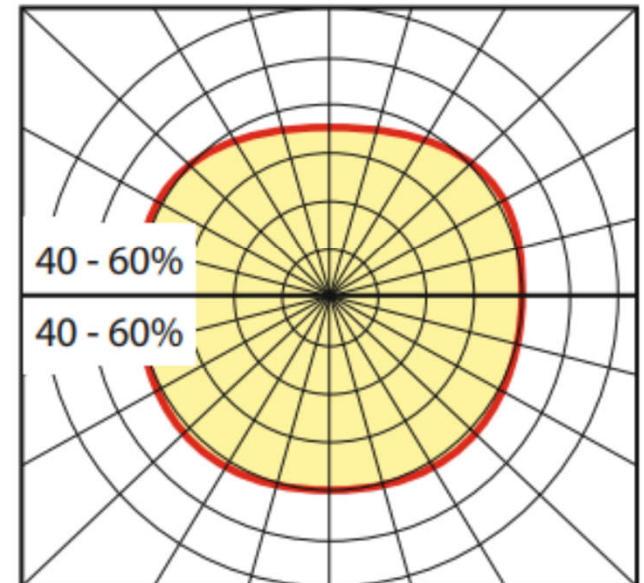

# Luminaires

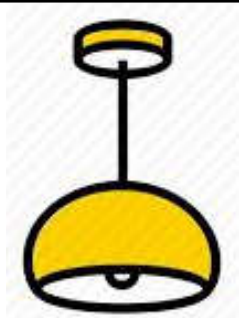

- Optical systems (for controlling light)
  - Reflection
    - Specular, diffuse, spread, selective
  - Transmission
    - Direct, diffuse, spread, selective
  - Refraction

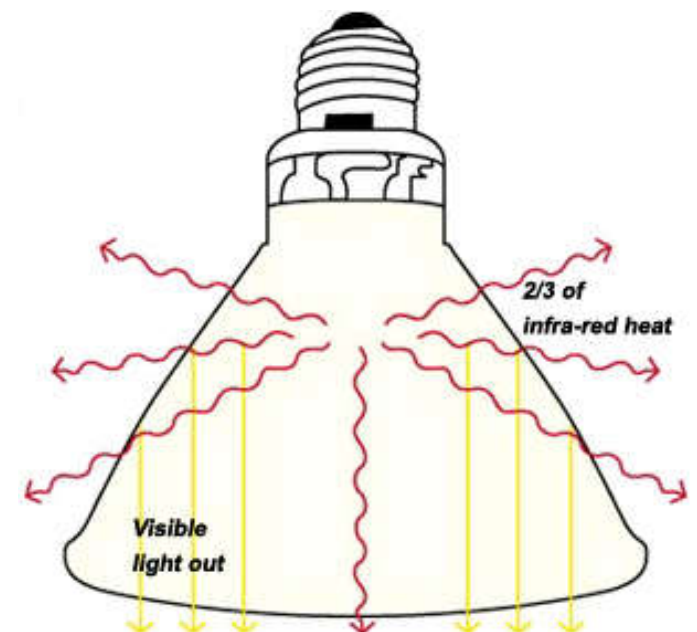
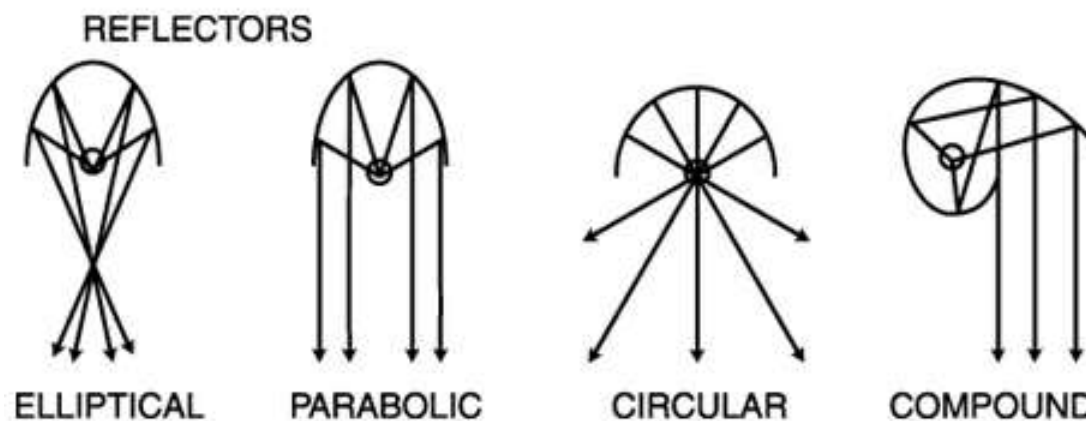

# Methods of controlling light

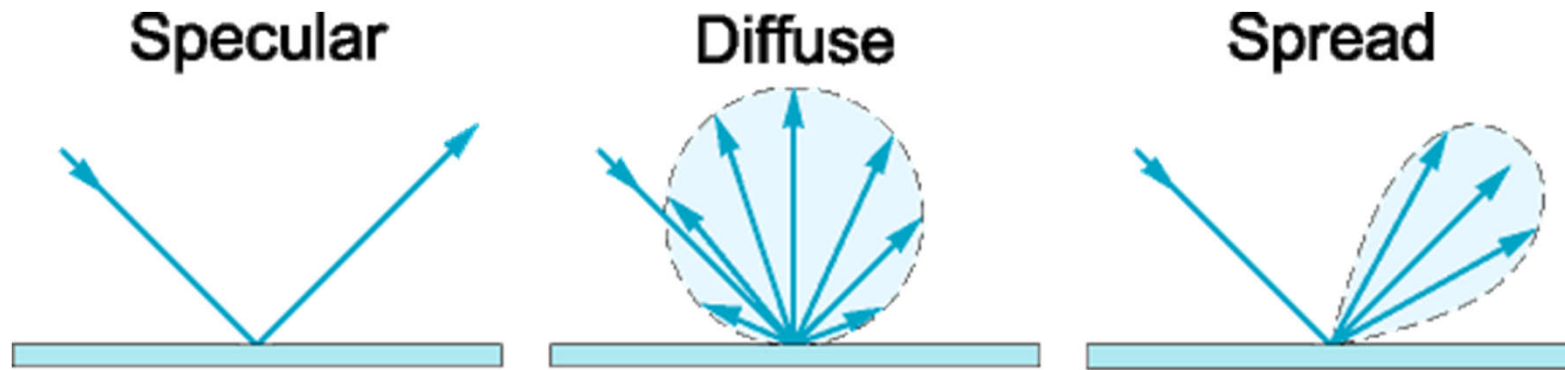

Fig. 3.2 Specular, diffuse, and spread reflection from a surface.

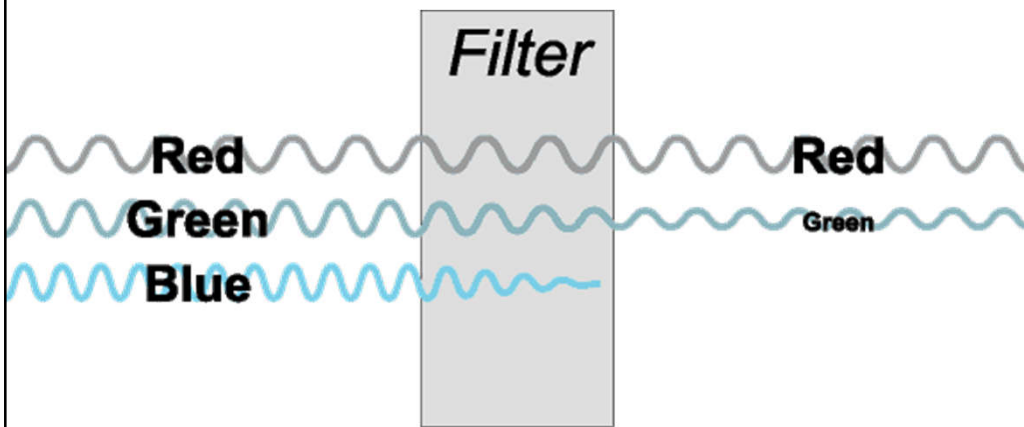

Fig. 3.3 Transmission through an optical filter.

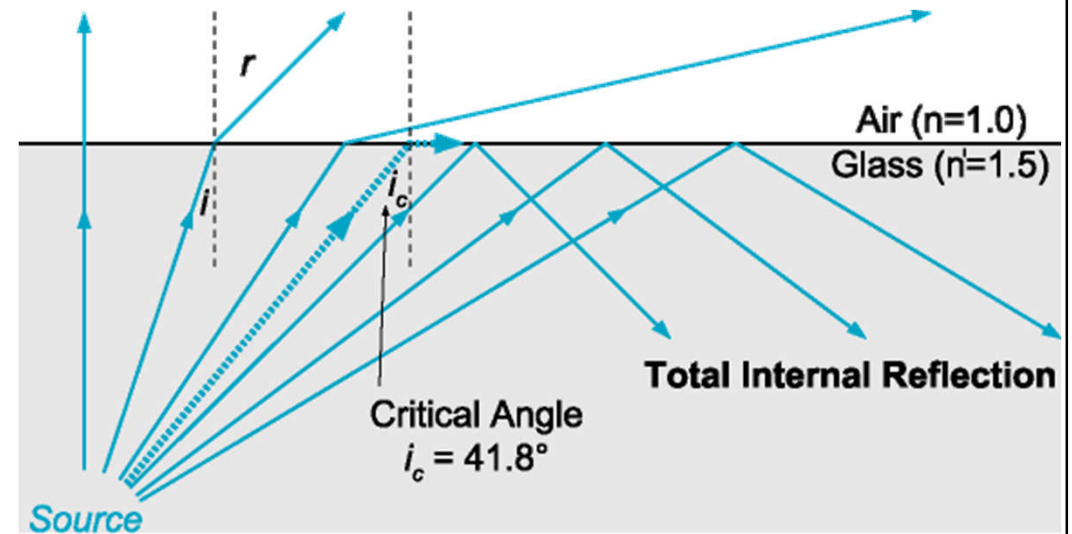
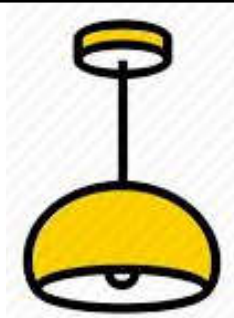
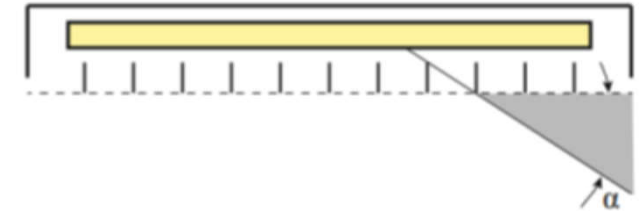
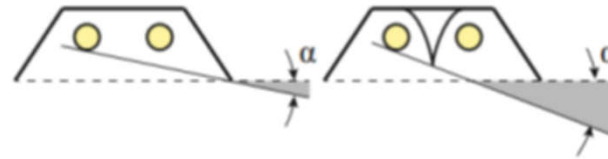

Fig. 3.5 Refraction and total internal reflection.

# Luminaires



- Shielding angle



- Shielding lamps from direct view into critical directions with the aid of the housing of the luminaire or with mirrors or baffles
- The higher the lamp luminance, the larger the shielding angle needs to be

- Beam angle

- Angle where the light intensity has fallen to 50% of the peak value

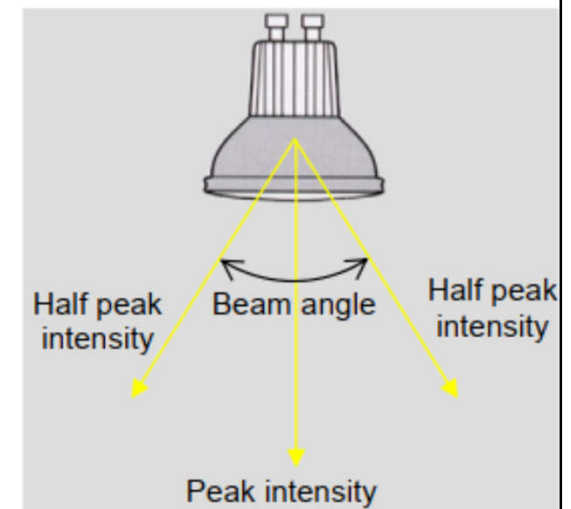



# Luminaires

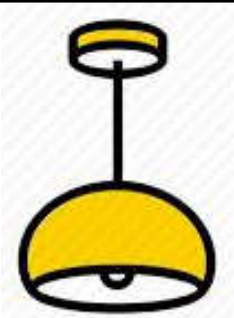

- Luminaires Efficacy Rating (LER)
  - $LER = (\text{Photometric Efficiency} \times \text{Total Lamp Lumens} \times \text{Ballast factor}) / \text{Luminaire Input Watts}$
- How to classify fluorescent luminaires & systems
  - Mounting: recessed, surface (ceiling or wall) & suspended
  - Distribution: direct, indirect, direct/indirect
  - Type of fluorescent lamp: T12, T8, T5
  - Nominal dimensions: 1 x 4, 2 x 4, etc
  - Application: commercial, industrial, residential, special purpose



# Further Reading

- The Electric Light (Edison Tech Center)  
<http://www.edisontechcenter.org/Lighting.html>
  - Incandescent Lamps  
<http://www.edisontechcenter.org/incandescent.html>
  - The Fluorescent Lamp  
<http://www.edisontechcenter.org/Fluorescent.html>
  - Mercury Vapor Lamps  
<http://www.edisontechcenter.org/MercuryVaporLamps.html>
  - Metal Halide Lamps <http://www.edisontechcenter.org/metalhalide.html>
  - Sodium Lamp <http://www.edisontechcenter.org/SodiumLamps.html>
  - LEDs and OLEDs <http://www.edisontechcenter.org/LED.html>
- Lamp types, lamp data and control gear  
<http://ibse.hk/IBTM6010J/Lamps.pdf>